

## SP4337 0.18pF 15KV Bidirectional TVS

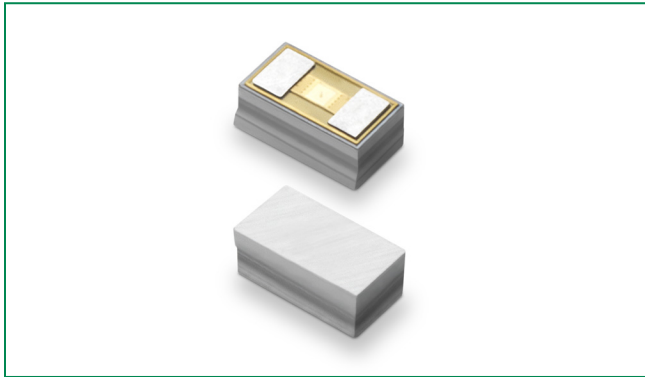

### Description

SP4337 is specifically designed to protect high-speed interfaces against ElectroStatic Discharge (ESD), such as High-Definition Multimedia Interface (HDMI) and DisplayPort interfaces, Thunderbolt and USB 3.1 Gen 1.

The signal line is protected by a TVS diode offering low line capacitance of 0.18 pF typical. SP4337 can safely absorb repetitive ESD strikes up to ±15 kV contact exceeding IEC 61000-4-2, level 4 ( ±8kV contact discharge).

Excellent low capacitance, clamping capability, low leakage, and fast response time make this parts an ideal solution for protecting high speed data lines.

### Pinout

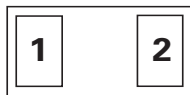

### Features

- ESD, IEC 61000-4-2, ±15kV contact , ±15kV Air
- EFT, IEC 61000-4-4, 40A (5/50ns)
- Lightning, 7A (8/20 as defined in IEC 61000-4-5 2nd edition)
- Low capacitance of 0.18pF (Typ @ VR=0V)
- Space efficient 0201
- Halogen free, lead free and RoHS compliant

### Functional Block Diagram



### Applications

- USB 4.0
- HDMI
- DisplayPort
- Thunderbolt
- S-ATA
- 2.5G/5G/10G Ethernet

Life Support Note:

**Not Intended for Use in Life Support or Life Saving Applications**

The products shown herein are not designed for use in life sustaining or life saving applications unless otherwise expressly indicated.

### Absolute Maximum Ratings

Symbol	Parameter	Value	Units
$I_{PP}$	Peak Current ( $t_p=8/20\mu s$ )	7.0	A
$T_{OP}$	Operating Temperature	-40 to 125	°C
$T_{STOR}$	Storage Temperature	-55 to 150	°C

CAUTION: Stresses above those listed in "Absolute Maximum Ratings" may cause permanent damage to the component. This is a stress only rating and operation of the component at these or any other conditions above those indicated in the operational sections of this specification is not implied.

### Electrical Characteristics ( $T_{OP}=25^\circ C$ )

Parameter	Symbol	Test Conditions	Min	Typ	Max	Units
Reverse Standoff Voltage	$V_{RWM}$	$I_R=1\mu A$			5	V
Breakdown Voltage	$V_{BR}$	$I_R=1mA$		7.8		V
Reverse Leakage Current	$I_{LEAK}$	$V_R=5V$		1	100	nA
Holding Voltage	$V_{HOLD}$	I/O to GND		2.3		V
Clamp Voltage <sup>1</sup>	$V_C$	$I_{PP}=7A, t_p=8/20\mu s, I/O$ to GND		5	7	V
Dynamic Resistance <sup>2</sup>	$R_{DYN}$	TLP, $t_p=100ns, I/O$ to GND		0.23		$\Omega$
ESD Withstand Voltage <sup>1</sup>	$V_{ESD}$	IEC 61000-4-2 (Contact Discharge)	$\pm 15$			kV
		IEC 61000-4-2 (Air Discharge)	$\pm 15$			kV
Diode Capacitance <sup>1</sup>	$C_{IO-GND}$	Reverse Bias=0V, $f=1MHz$		0.18		pF

Note:

- Parameter is guaranteed by design and/or component characterization.
- Transmission Line Pulse (TLP) with 100ns width, 0.2ns rise time, and average window  $t1=70ns$  to  $t2=90ns$

### Capacitance vs Reverse Bias

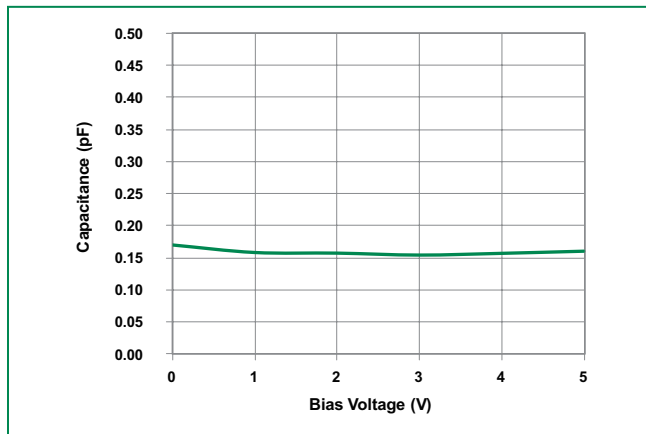

### Clamping Voltage vs $I_{PP}$

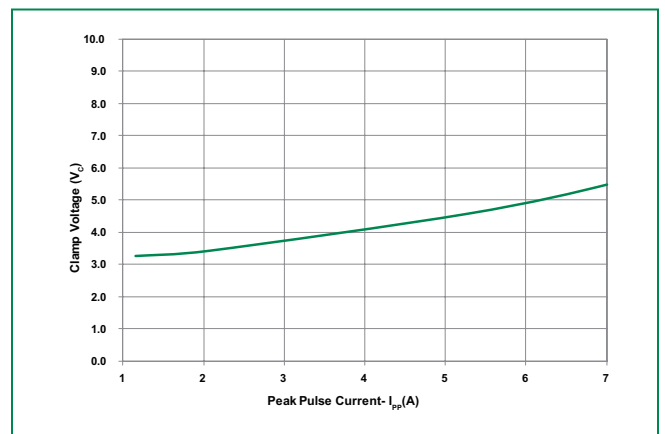

**Positive Transmission Line Pulsing (TLP) Plot**

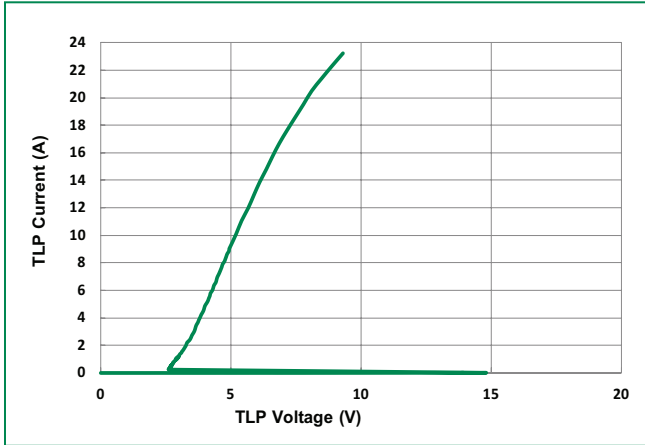

**Negative Transmission Line Pulsing (TLP) Plot**

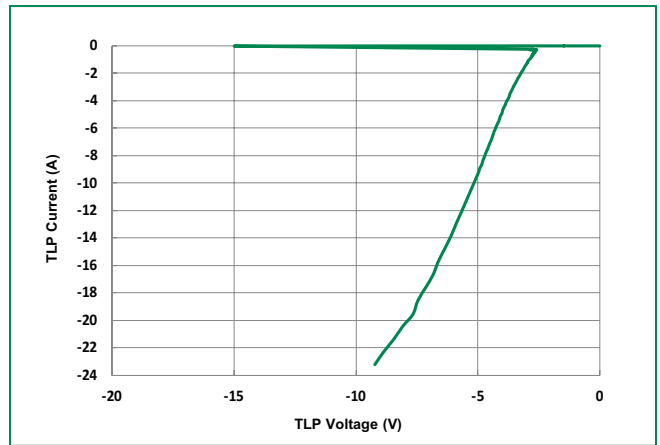

**8/20µs Pulse Waveform**

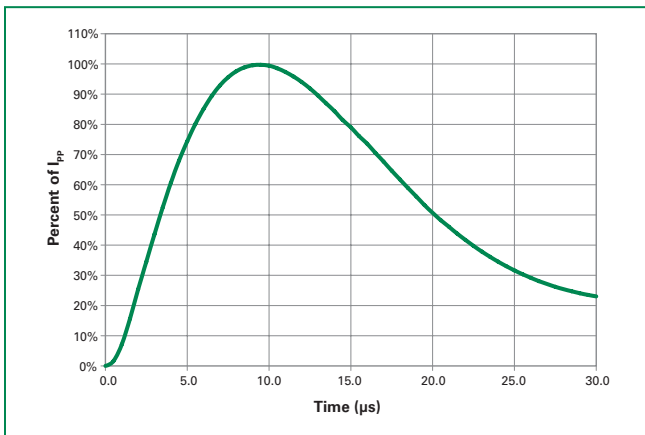

**IEC 61000-4-2 +8 kV Contact ESD Clamping Voltage**

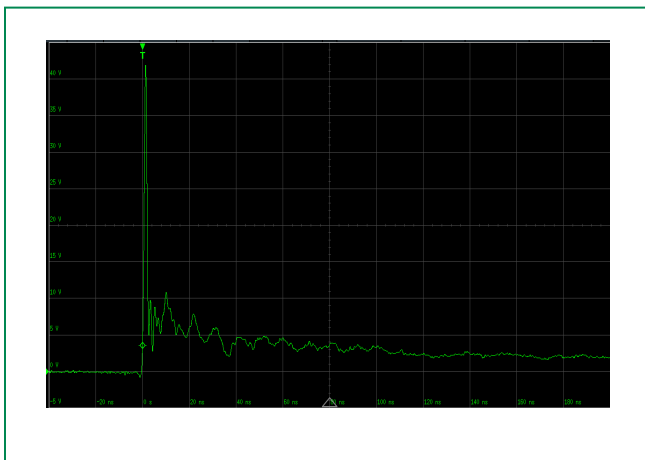

**IEC 61000-4-2 -8 kV Contact ESD Clamping Voltage**

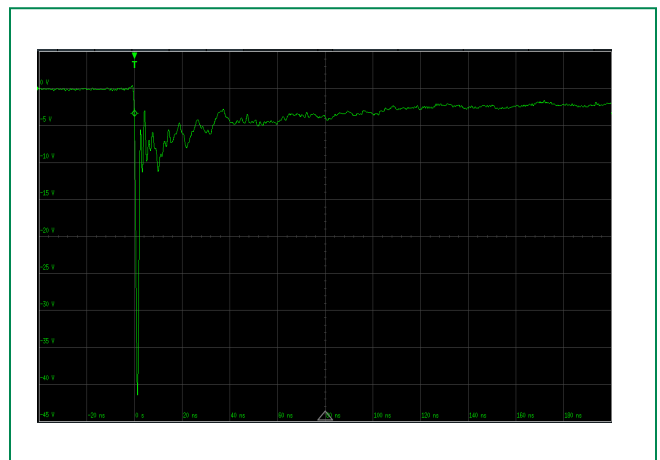

**Soldering Parameters**

Reflow Condition		Pb – Free assembly
Pre Heat	- Temperature Min ( $T_{s(min)}$ )	150°C
	- Temperature Max ( $T_{s(max)}$ )	200°C
	- Time (min to max) ( $t_s$ )	60 – 180 secs
Average ramp up rate (Liquidus) Temp ( $T_L$ ) to peak		3°C/second max
$T_{s(max)}$ to $T_L$ - Ramp-up Rate		3°C/second max
Reflow	- Temperature ( $T_L$ ) (Liquidus)	217°C
	- Temperature ( $t_L$ )	60 – 150 seconds
Peak Temperature ( $T_p$ )		260 <sup>+0/-5</sup> °C
Time within 5°C of actual peak Temperature ( $t_p$ )		20 – 40 seconds
Ramp-down Rate		6°C/second max
Time 25°C to peak Temperature ( $T_p$ )		8 minutes Max.
Do not exceed		260°C

**Ordering Information**

Part Number	Package	Min. Order Qty.
SP4337-01WTG	Flipchip	10000

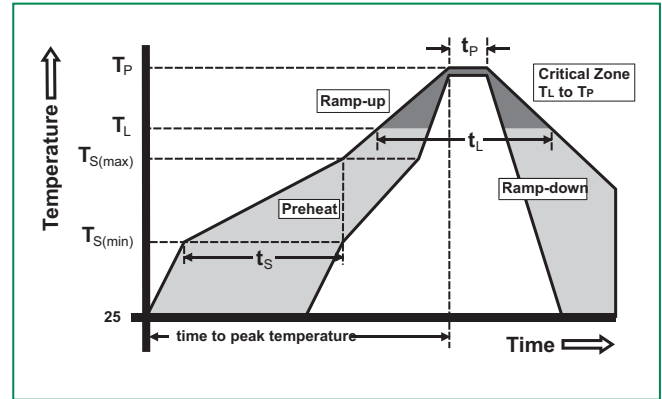

**Product Characteristics**

<b>Lead Plating</b>	Tin plating
<b>Lead Material</b>	Copper bump
<b>Substrate Material</b>	Silicon
<b>Flammability</b>	UL Recognized compound meeting flammability rating V-0

**Part Marking System**

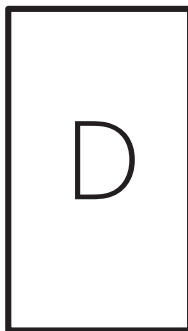

**Part Numbering System**

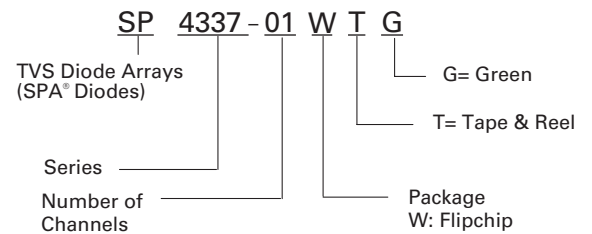

### Package Dimensions – FLIPCHIP

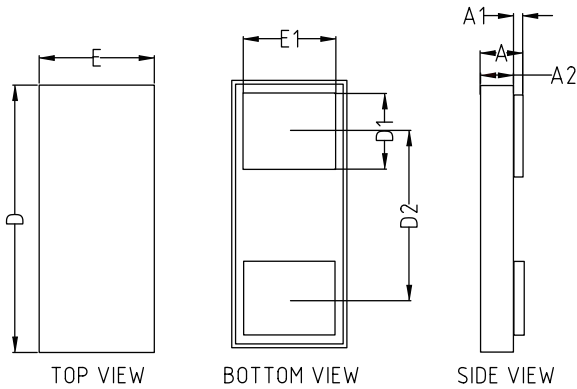

Symbol	0201 Flipchip			
	Millimeters		Inches	
	Min	Max	Min	Max
<b>D</b>	0.605	0.655	0.0238	0.0258
<b>E</b>	0.305	0.355	0.0120	0.0140
<b>D1</b>	0.145	0.155	0.0057	0.0061
<b>E1</b>	0.245	0.255	0.0096	0.0100
<b>D2</b>	0.400 BSC		0.0157 BSC	
<b>A</b>	0.273	0.329	0.0107	0.0130
<b>A2</b>	0.265	0.315	0.0104	0.0124
<b>A1</b>	0.008	0.014	0.0003	0.0006

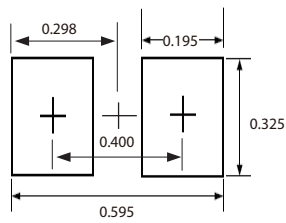

Recommended Soldering Pad Layout (mm)

### Embossed Carrier Tape & Reel Specification – FLIPCHIP

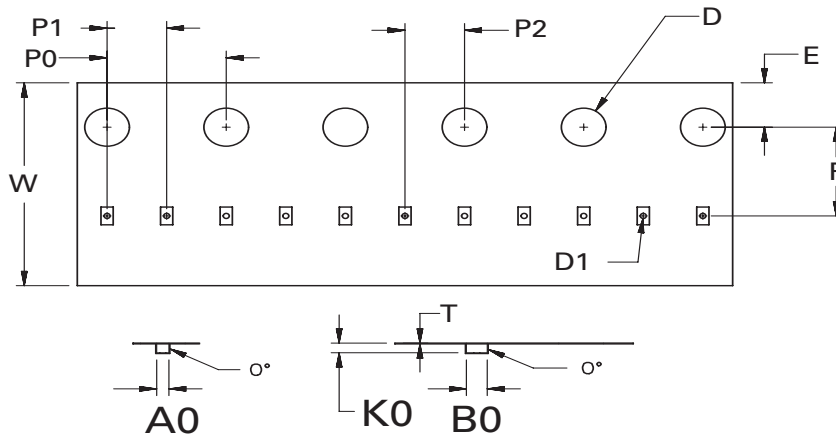

Symbol	Millimeters
<b>A0</b>	0.41 +/- 0.03
<b>B0</b>	0.70 +/- 0.03
<b>D</b>	ø 1.50 + 0.10
<b>D1</b>	ø 0.20 +/- 0.05
<b>E</b>	1.75 +/- 0.10
<b>F</b>	3.50 +/- 0.05
<b>K0</b>	0.38 +/- 0.03
<b>P0</b>	4.00 +/- 0.10
<b>P1</b>	2.00 +/- 0.05
<b>P2</b>	2.00 +/- 0.05
<b>W</b>	8.00 +/- 0.30/-0.10
<b>T</b>	0.23 +/- 0.02

**Product Disclaimer:** Littelfuse products are not designed for, and shall not be used for, any purpose (including, without limitation, automotive, military, aerospace, medical, life-saving, life-sustaining or nuclear facility applications, devices intended for surgical implant into the body, or any other application in which the failure or lack of desired operation of the product may result in personal injury, death, or property damage) other than those expressly set forth in applicable Littelfuse product documentation. Warranties granted by Littelfuse shall be deemed void for products used for any purpose not expressly set forth in applicable Littelfuse documentation. Littelfuse shall not be liable for any claims or damages arising out of products used in applications not expressly intended by Littelfuse as set forth in applicable Littelfuse documentation. The sale and use of Littelfuse products is subject to Littelfuse Terms and Conditions of Sale, unless otherwise agreed by Littelfuse. "Littelfuse" includes Littelfuse, Inc., and all of its affiliate entities. <http://www.littelfuse.com/disclaimer-electronics>.