

PTFB192503FL

Thermally-Enhanced High Power RF LDMOS FET 240 W, 1930 – 1990 MHz

Description

The PTFB192503FL is a 240-watt LDMOS FET intended for use in multi-standard cellular power amplifier applications in the 1930 to 1990 MHz frequency band. Features include input and output matching, high gain, wide signal bandwidth and reduced memory effects for improved DPD correctability. Manufactured with Wolfspeed's advanced LDMOS process, this device provides excellent thermal performance and superior reliability.

PTFB192503FL
Package H-34288-4/2

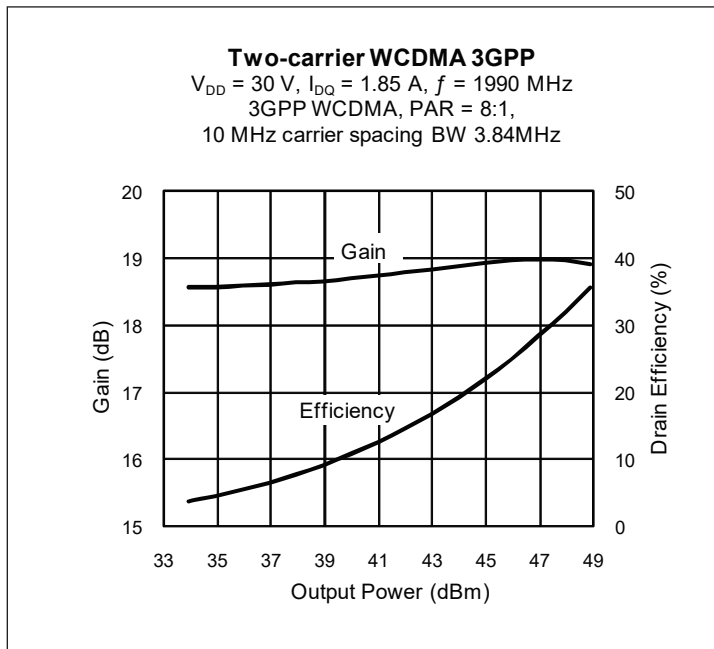
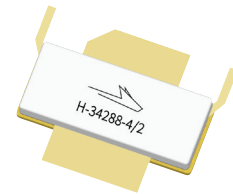

Features

- Broadband internal input and output matching
- Enhanced for use in DPD error correction systems
- Typical two-carrier WCDMA performance, 30 V, 1990 MHz
 - Average output power = 50 W
 - Linear gain = 19 dB
 - Drain efficiency = 28 %
 - Intermodulation distortion = -35 dBc
- Typical CW performance, 1990 MHz, 30 V
 - Output power at P_{1dB} = 240 W
 - Efficiency = 55%
- Increased negative gate-source voltage range for improved performance in Doherty peaking amplifiers
- Integrated ESD protection. Human Body Model, Class 2 (minimum)
- Capable of handling 10:1 VSWR @ 30 V, 240 W (CW) output power
- Pb-free, RoHS-compliant

RF Characteristics

Two-carrier WCDMA Measurements (not subject to production test—verified by design/characterization in Wolfspeed test fixture)

$V_{DD} = 30\text{ V}$, $I_{DQ} = 1.9\text{ A}$, $P_{OUT} = 50\text{ W}$ average, $f_1 = 1980\text{ MHz}$, $f_2 = 1990\text{ MHz}$, 3GPP signal, channel bandwidth = 3.84 MHz, peak/average = 8:1 dB @ 0.01% CCDF

Characteristic	Symbol	Min	Typ	Max	Unit
Gain	G_{ps}	—	19	—	dB
Drain Efficiency	η_D	—	28	—	%
Intermodulation Distortion	IMD	—	-35	—	dBc

All published data at $T_{CASE} = 25^\circ\text{C}$ unless otherwise indicated

ESD: Electrostatic discharge sensitive device—observe handling precautions!

RF Characteristics (cont.)

Two-tone Measurements (tested in Wolfspeed test fixture)

$V_{DD} = 30\text{ V}$, $I_{DQ} = 1.9\text{ A}$, $P_{OUT} = 220\text{ W PEP}$, $f = 1990\text{ MHz}$, tone spacing = 1 MHz

Characteristic	Symbol	Min	Typ	Max	Unit
Gain	G_{ps}	17	18	—	dB
Drain Efficiency	η_D	40	41.5	—	%
Intermodulation Distortion	IMD	—	-29	-27	dBc

DC Characteristics

Characteristic	Conditions	Symbol	Min	Typ	Max	Unit
Drain-Source Breakdown Voltage	$V_{GS} = 0\text{ V}$, $I_{DS} = 10\text{ mA}$	$V_{(BR)DSS}$	65	—	—	V
Drain Leakage Current	$V_{DS} = 28\text{ V}$, $V_{GS} = 0\text{ V}$	I_{DSS}	—	—	1.0	μA
Drain Leakage Current	$V_{DS} = 63\text{ V}$, $V_{GS} = 0\text{ V}$	I_{DSS}	—	—	10.0	μA
On-State Resistance	$V_{GS} = 10\text{ V}$, $V_{DS} = 0.1\text{ V}$	$R_{DS(on)}$	—	0.03	—	Ω
Operating Gate Voltage	$V_{DS} = 30\text{ V}$, $I_{DQ} = 1.9\text{ A}$	V_{GS}	2.3	2.8	3.3	V
Gate Leakage Current	$V_{GS} = 10\text{ V}$, $V_{DS} = 0\text{ V}$	I_{GSS}	—	—	1.0	μA

Maximum Ratings

Parameter	Symbol	Value	Unit
Drain-Source Voltage	V_{DSS}	65	V
Gate-Source Voltage	V_{GS}	-6 to +10	V
Junction Temperature	T_J	200	$^{\circ}\text{C}$
Storage Temperature Range	T_{STG}	-40 to +150	$^{\circ}\text{C}$
Thermal Resistance ($T_{CASE} = 70^{\circ}\text{C}$, 200 W CW)	$R_{\theta JC}$	0.262	$^{\circ}\text{C/W}$

Ordering Information

Type and Version	Order Code	Package Description	Shipping
PTFB192503FL V2 R0	PTFB192503FL-V2-R0	H-34288-4/2, earless	Tape & Reel, 50pcs
PTFB192503FL V2 R250	PTFB192503FL-V2-R250	H-34288-4/2, earless	Tape & Reel, 250pcs

Typical Performance (data taken in a production test fixture)

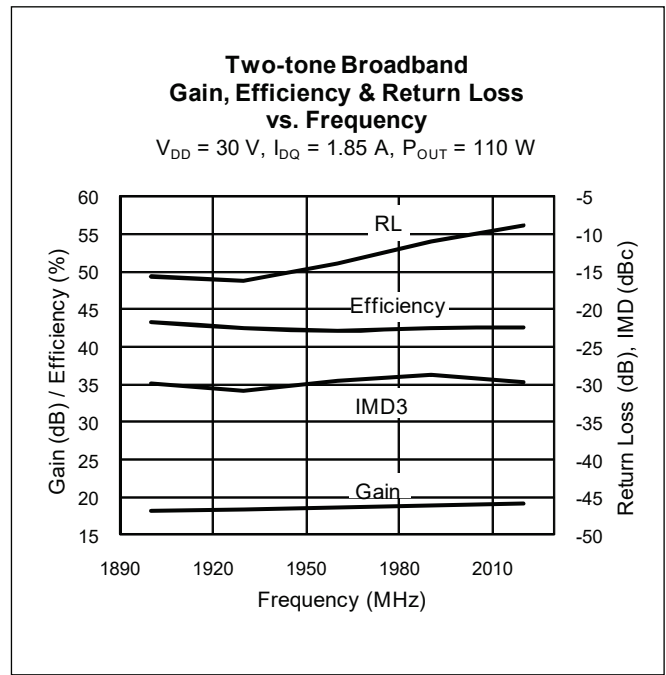
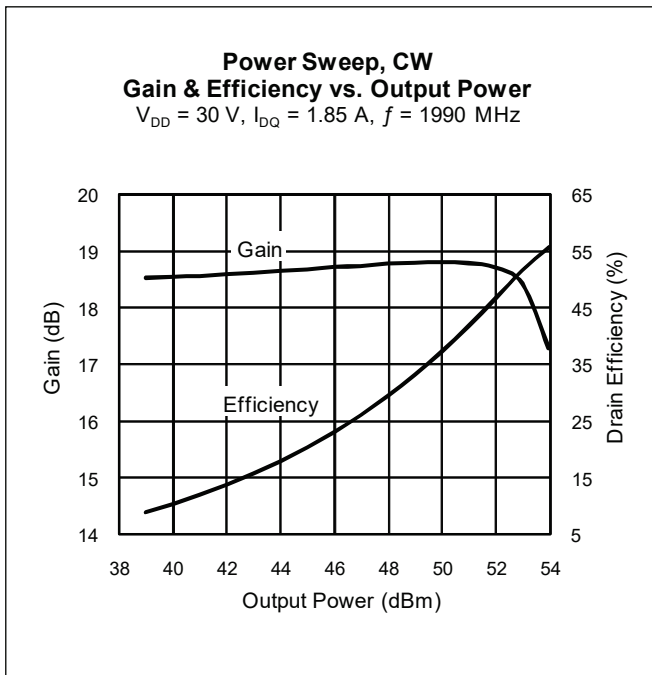
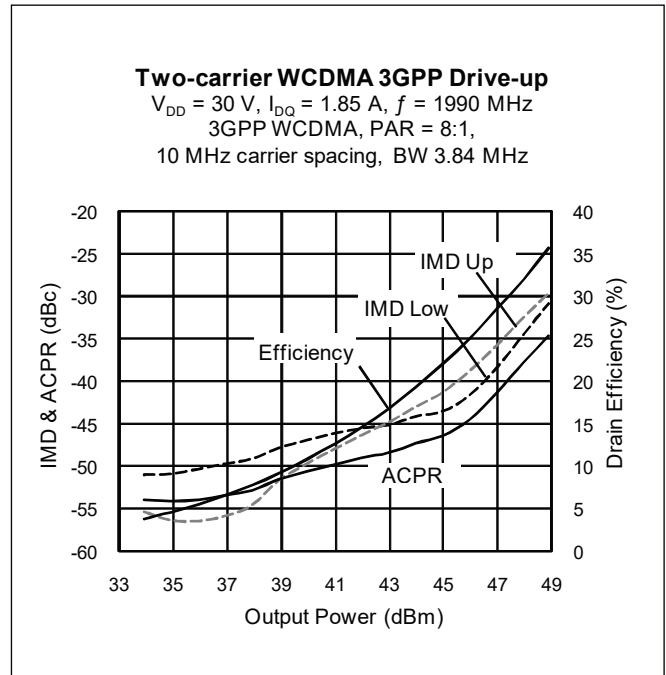
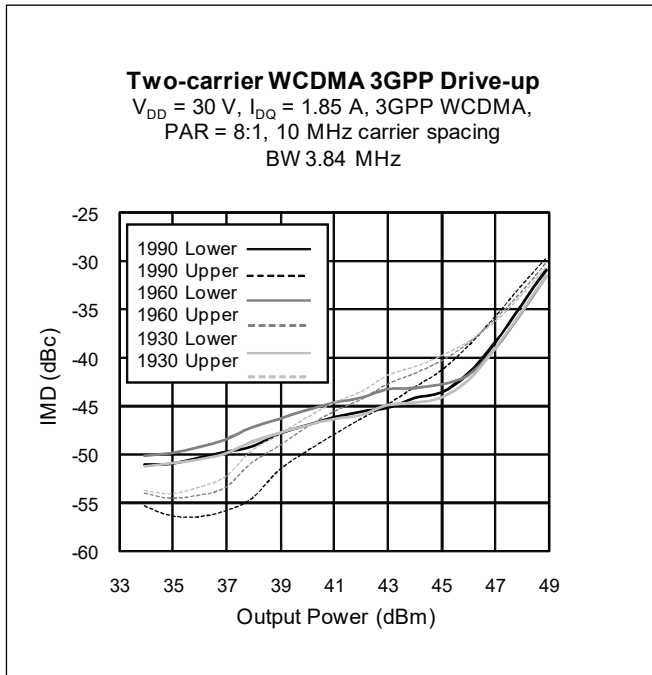



Typical Performance (cont.)

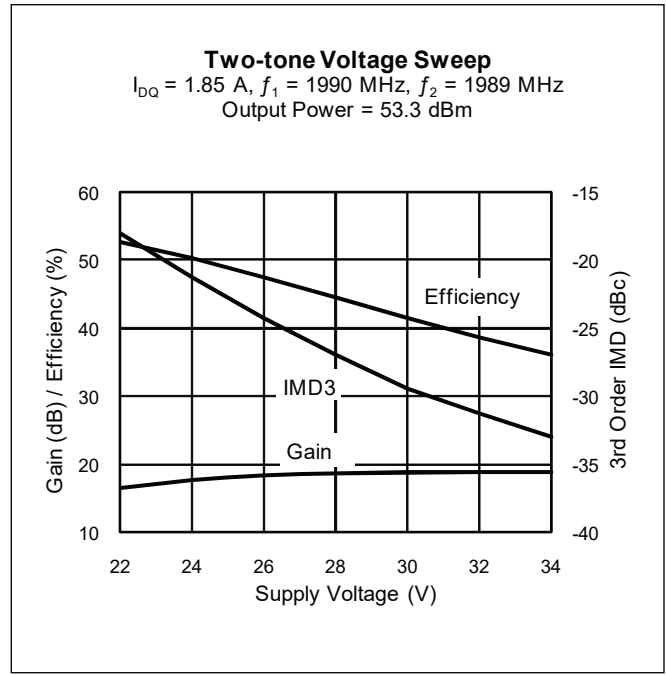
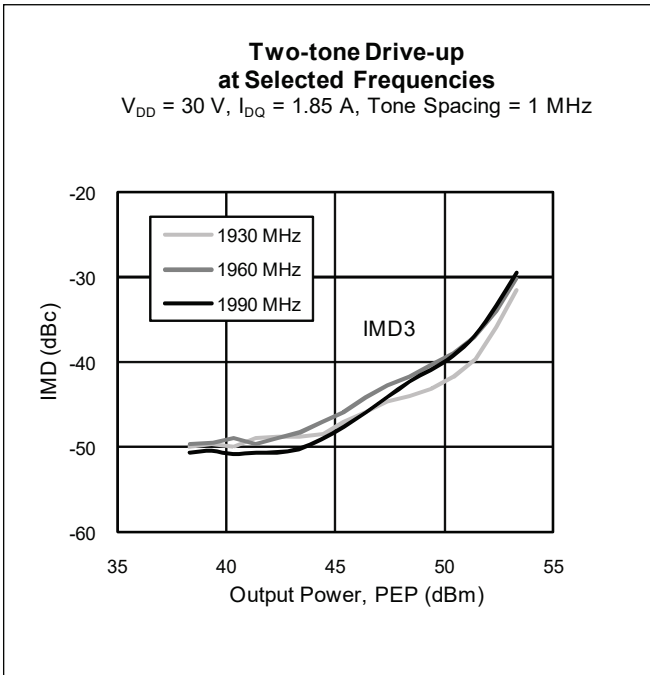
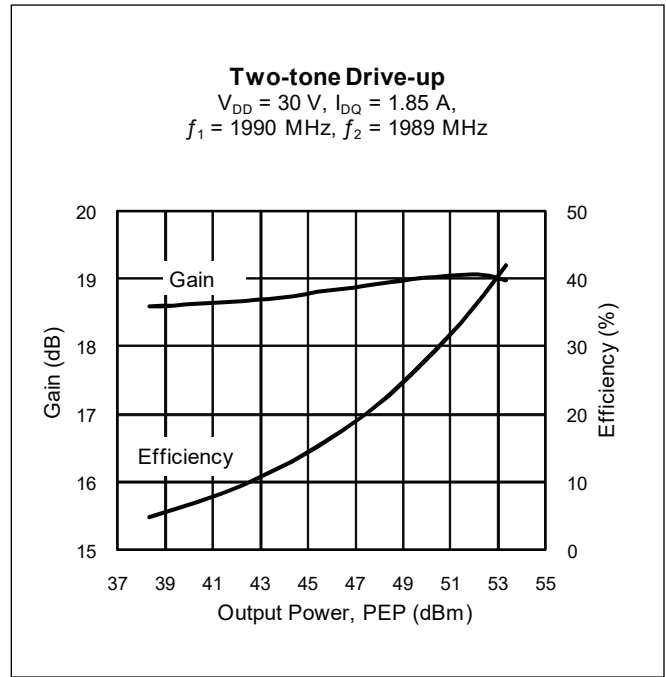
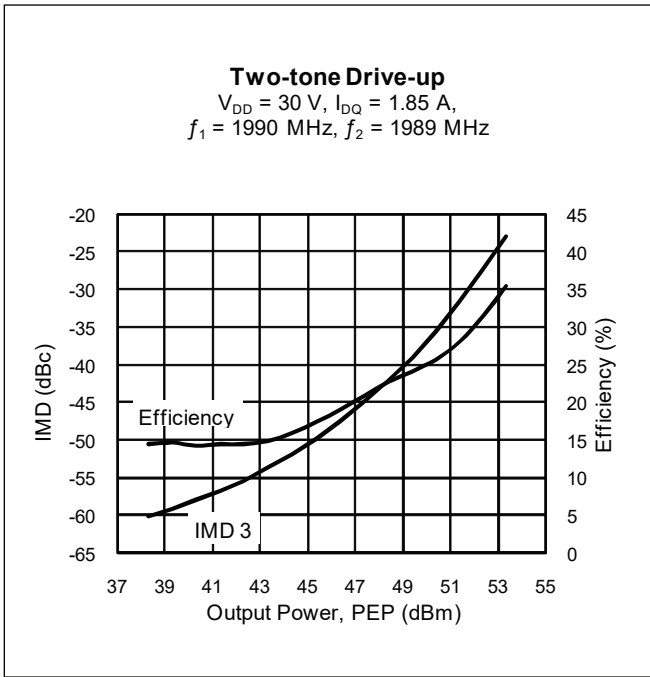



Typical Performance (cont.)

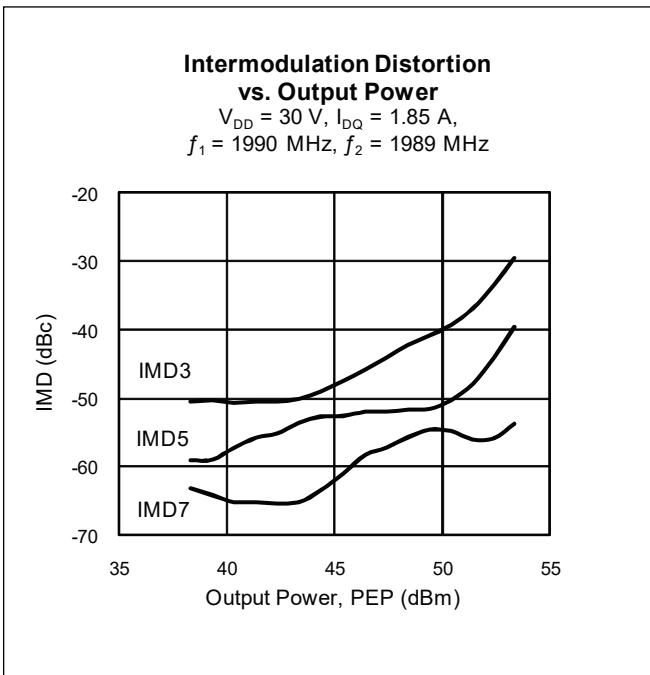
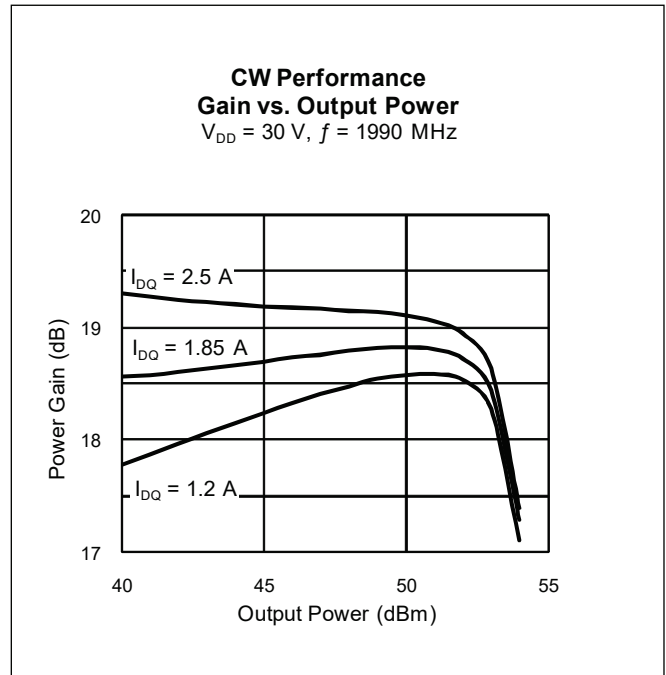
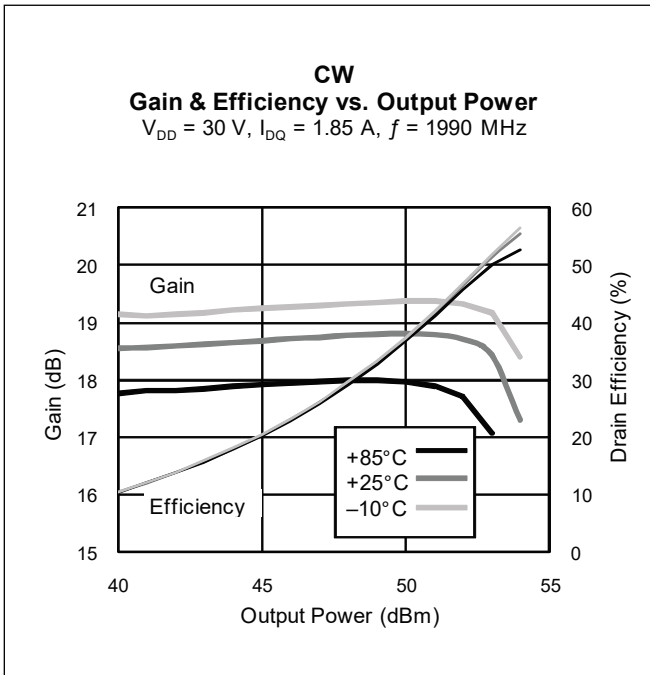

Broadband Circuit Impedance

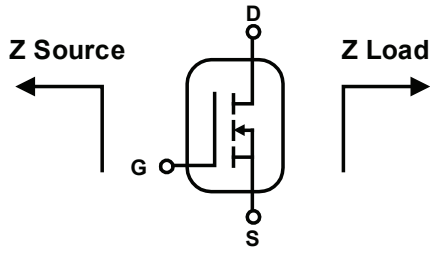

Frequency MHz	Z Source Ω		Z Load Ω	
	R	jX	R	jX
1900	2.63	-3.92	1.36	-4.49
1930	2.56	-3.67	1.33	-4.35
1960	2.48	-3.44	1.31	-4.21
1990	2.42	-3.21	1.28	-4.07
2020	2.35	-2.98	1.26	-3.93

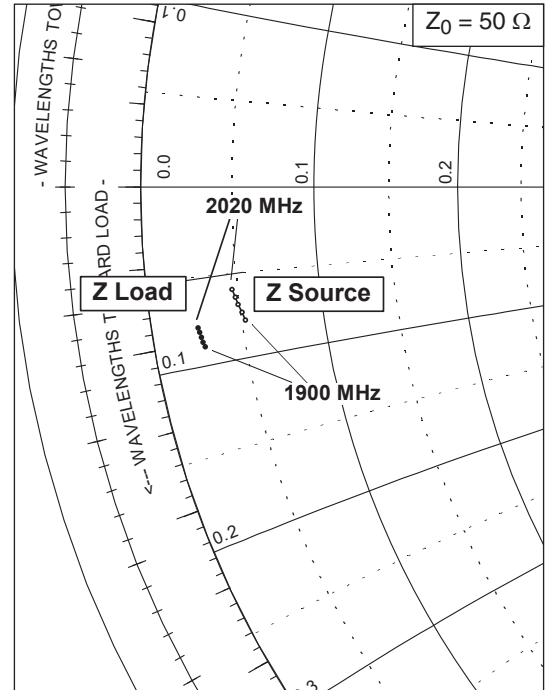

See next page for reference circuit information

Reference Circuit

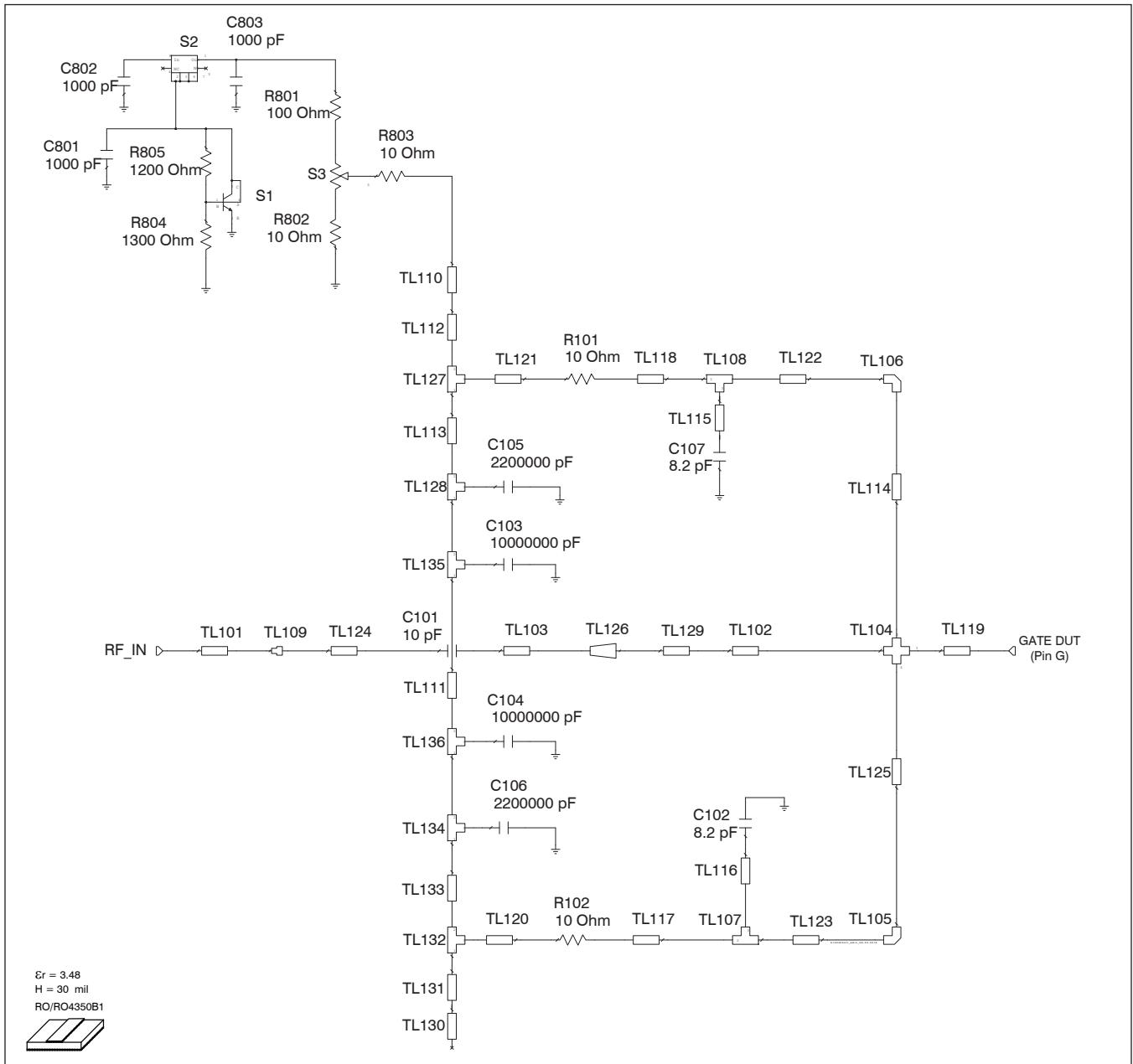

Reference circuit input schematic for $f = 1990$ MHz

Reference Circuit (cont.)

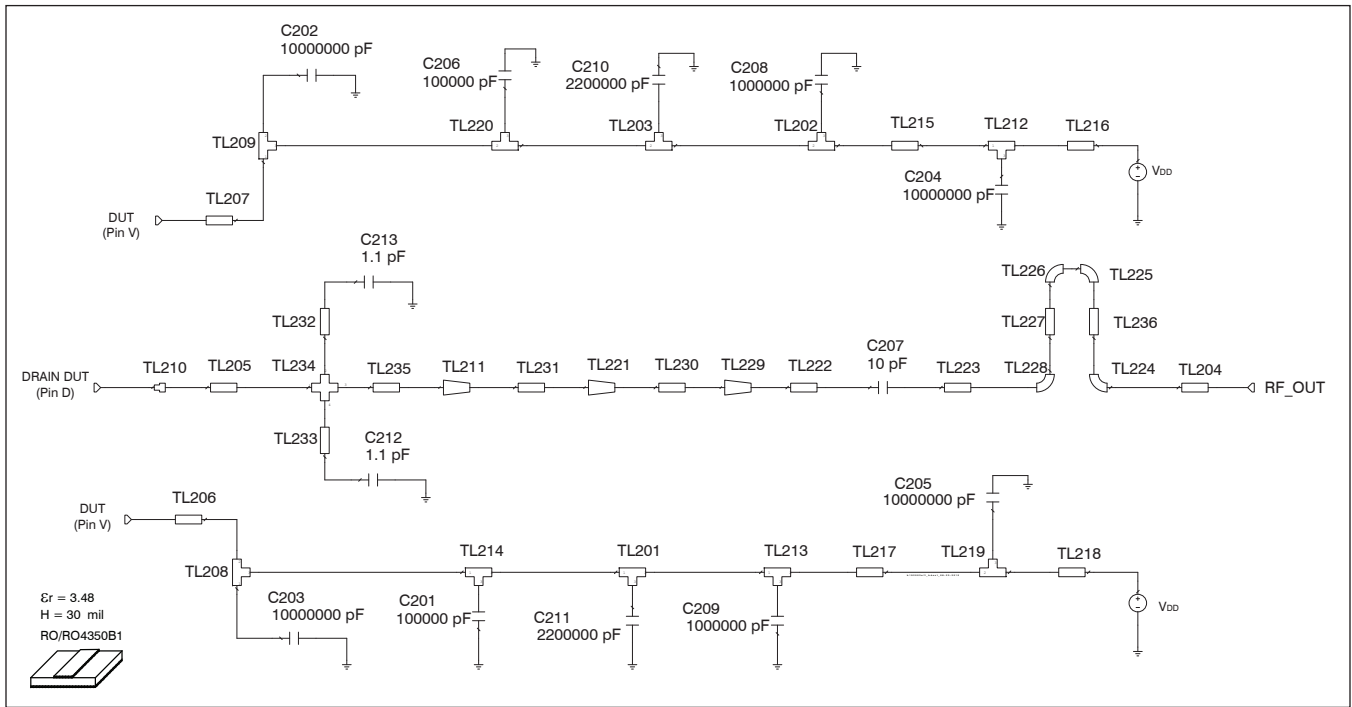

Reference circuit output schematic for $f = 1990$ MHz

See next page for more reference circuit information

Reference Circuit (cont.)

Description	
DUT	PTFB192503FL
PCB	0.76 mm [.030"] thick, $\epsilon_r = 3.48$, Rogers 4350, 1 oz. copper

Electrical Characteristics at 1990 MHz

Transmission Line	Electrical Characteristics	Dimensions: mm	Dimensions: mils
Input			
TL224	0.000 λ , 144.35 Ω	W1 = 0.025, W2 = 0.025, W3 = 0.025	W1 = 1, W2 = 1, W3 = 1
TL101	0.037 λ , 51.58 Ω	W = 1.651, L = 3.358	W = 65, L = 132
TL102	0.053 λ , 9.67 Ω	W = 13.970, L = 4.470	W = 550, L = 176
TL103	0.033 λ , 51.58 Ω	W = 1.651, L = 3.018	W = 65, L = 119
TL104		W1 = 13.970, W2 = 0.762, W3 = 13.970, W4 = 0.762	W1 = 550, W2 = 30, W3 = 550, W4 = 30
TL105, TL106		W = 0.762	W = 30
TL107, TL108	0.011 λ , 78.27 Ω	W1 = 0.762, W2 = 0.762, W3 = 1.016	W1 = 30, W2 = 30, W3 = 40
TL109		W1 = 1.651, W2 = 2.032	W1 = 65, W2 = 80
TL110, TL130	0.015 λ , 38.82 Ω	W = 2.540, L = 1.321	W = 100, L = 52
TL111	0.071 λ , 92.53 Ω	W = 0.508, L = 6.756	W = 20, L = 266
TL112	0.016 λ , 68.02 Ω	W = 1.016, L = 1.524	W = 40, L = 60
TL113, TL133	0.024 λ , 78.27 Ω	W = 0.762, L = 2.286	W = 30, L = 90
TL114, TL125	0.023 λ , 78.27 Ω	W = 0.762, L = 2.159	W = 30, L = 85
TL115, TL116	0.001 λ , 68.02 Ω	W = 1.016, L = 0.127	W = 40, L = 5
TL117, TL118	0.014 λ , 78.27 Ω	W = 0.762, L = 1.270	W = 30, L = 50
TL119	0.024 λ , 9.67 Ω	W = 13.970, L = 1.981	W = 550, L = 78
TL120, TL121	0.007 λ , 68.02 Ω	W = 1.016, L = 0.686	W = 40, L = 27
TL122, TL123	0.125 λ , 78.27 Ω	W = 0.762, L = 11.684	W = 30, L = 460
TL124	0.008 λ , 45.17 Ω	W = 2.032, L = 0.762	W = 80, L = 30
TL126 (taper)	0.030 λ , 9.67 Ω / 51.58 Ω	W1 = 13.970, W2 = 1.651, L = 2.515	W1 = 550, W2 = 65, L = 99
TL127, TL132	0.011 λ , 68.02 Ω	W1 = 1.016, W2 = 1.016, W3 = 1.016	W1 = 40, W2 = 40, W3 = 40
TL128	0.022 λ , 78.27 Ω	W1 = 0.762, W2 = 0.762, W3 = 2.032	W1 = 30, W2 = 30, W3 = 80
TL129	0.077 λ , 9.67 Ω	W = 13.970, L = 6.502	W = 550, L = 256
TL131	0.016 λ , 68.02 Ω	W = 1.016, L = 1.524	W = 40, L = 60
TL134	0.022 λ , 78.27 Ω	W1 = 0.762, W2 = 0.762, W3 = 2.032	W1 = 30, W2 = 30, W3 = 80
TL135, TL136	0.016 λ , 92.53 Ω	W1 = 0.508, W2 = 0.508, W3 = 1.524	W1 = 20, W2 = 20, W3 = 60

table continued on page 10

Reference Circuit (cont.)

Electrical Characteristics at 1990 MHz

Transmission Line	Electrical Characteristics	Dimensions: mm	Dimensions: mils
Output			
TL201, TL202, TL203, TL213	0.026 λ , 34.08 Ω	W1 = 3.048, W2 = 3.048, W3 = 2.286	W1 = 120, W2 = 120, W3 = 90
TL204	0.012 λ , 51.58 Ω	W = 1.651, L = 1.118	W = 65, L = 44
TL205	0.084 λ , 6.86 Ω	W = 20.320, L = 6.985	W = 800, L = 275
TL206	0.029 λ , 23.60 Ω	W = 4.928, L = 2.540	W = 194, L = 100
TL207	0.029 λ , 23.79 Ω	W = 4.877, L = 2.540	W = 192, L = 100
TL208, TL209, TL212	0.034 λ , 34.08 Ω	W1 = 3.048, W2 = 3.048, W3 = 3.048	W1 = 120, W2 = 120, W3 = 120
TL210		W1 = 12.700, W2 = 17.780	W1 = 500, W2 = 700
TL211 (taper)	0.019 λ , 6.86 Ω / 8.37 Ω	W1 = 20.320, W2 = 16.383, L = 1.575	W1 = 800, W2 = 645, L = 62
TL214, TL220	0.009 λ , 34.08 Ω	W1 = 3.048, W2 = 3.048, W3 = 0.762	W1 = 120, W2 = 120, W3 = 30
TL215, TL217	0.118 λ , 34.08 Ω	W = 3.048, L = 10.516	W = 120, L = 414
TL216	0.019 λ , 34.08 Ω	W = 3.048, L = 1.702	W = 120, L = 67
TL218	0.025 λ , 34.08 Ω	W = 3.048, L = 2.210	W = 120, L = 87
TL219	0.034 λ , 34.08 Ω	W1 = 3.048, W2 = 3.048, W3 = 3.048	W1 = 120, W2 = 120, W3 = 120
TL221 (taper)	0.041 λ , 8.37 Ω / 19.45 Ω	W1 = 16.383, W2 = 6.248, L = 3.429	W1 = 645, W2 = 246, L = 135
TL222	0.007 λ , 51.58 Ω	W = 1.651, L = 0.635	W = 65, L = 25
TL223	0.011 λ , 45.17 Ω	W = 2.032, L = 1.016	W = 80, L = 40
TL224, TL225, TL226, TL228		W = 0.002, ANG = 90, R = 0.002	W = 2, ANG = 3543307, R = 70
TL227	0.014 λ , 51.58 Ω	W = 1.651, L = 1.270	W = 65, L = 50
TL229 (taper)	0.019 λ , 19.45 Ω / 51.58 Ω	W1 = 6.248, W2 = 1.651, L = 1.651	W1 = 246, W2 = 65, L = 65
TL230	0.000 λ , 19.45 Ω	W = 6.248, L = 0.025	W = 246, L = 1
TL231	0.000 λ , 8.37 Ω	W = 16.383, L = 0.025	W = 645, L = 1
TL232, TL233	0.000 λ , 146.88 Ω	W = 0.025, L = 0.025	W = 1, L = 1
TL234		W1 = 20.320, W2 = 0.025, W3 = 20.320, W4 = 0.025	W1 = 800, W2 = 1, W3 = 800, W4 = 1
TL235	0.005 λ , 6.86 Ω	W = 20.320, L = 0.406	W = 800, L = 16
TL236	0.014 λ , 51.58 Ω	W = 1.651, L = 1.270	W = 65, L = 50



Reference Circuit (cont.)

Circuit Assembly Information

Test Fixture Part No. LTN/PTFB192503EF

Find Gerber files for this test fixture on the WolfSpeed Web site at www.wolfspeed.com/RF

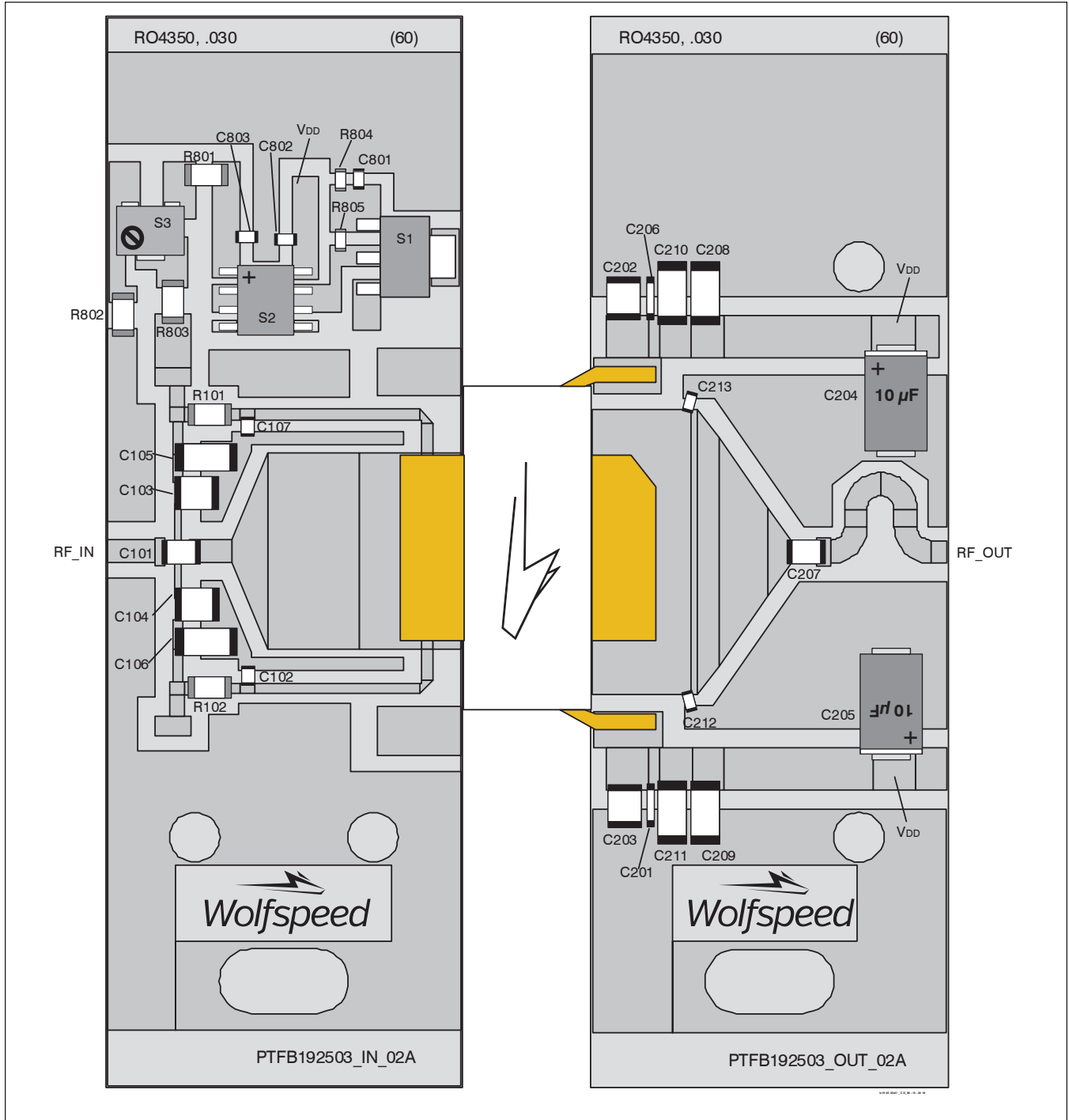

Reference circuit assembly diagram (not to scale)



Reference Circuit (cont.)

Component	Description	Suggested Manufacturer	P/N
Input			
C101	Chip capacitor, 10 pF	ATC	ATC100B100FW500XB
C102, C107	Chip capacitor, 8.2 pF	ATC	ATC100A8R2BW150XB
C103, C104	Capacitor, 10 μ F	Digi-Key	587-1818-2-ND
C105, C106	Chip capacitor, 2.2 μ F	Digi-Key	445-1447-2-ND
C801, C802, C803	Capacitor, 1000 pF	Digi-Key	PCC1772CT-ND
R101, R102, R802, R803	Resistor, 10 Ω	Digi-Key	P10ECT-ND
R801	Resistor, 100 Ω	Digi-Key	P100ECT-ND
R804	Resistor, 1300 Ω	Digi-Key	P1.3KGCT-ND
R805	Resistor, 1200 Ω	Digi-Key	P1.2KGCT-ND
S1	Transistor	Digi-Key	BCP5616TA-ND
S2	Voltage Regulator	Digi-Key	LM78L05ACM-ND
S3	Potentiometer, 2k Ω	Digi-Key	3224W-202ECT-ND
Output			
C201, C206	Chip capacitor, 0.1 μ F	Digi-Key	399-1267-2-ND
C202, C203	Chip capacitor, 10 μ F	Digi-Key	587-1818-2-ND
C204, C205	Capacitor, 10 μ F	Digi-Key	281M5002106K
C207	Capacitor, 10 pF	ATC	ATC100B100FW500XB
C208, C209	Chip capacitor, 1 μ F	Digi-Key	445-1411-2-ND
C210, C211	Chip capacitor, 2.2 μ F	Digi-Key	445-1447-2-ND
C212, C213	Chip capacitor, 1.1 pF	ATC	ATC100A1R1BW150XB

Package Outline Specifications (cont.)

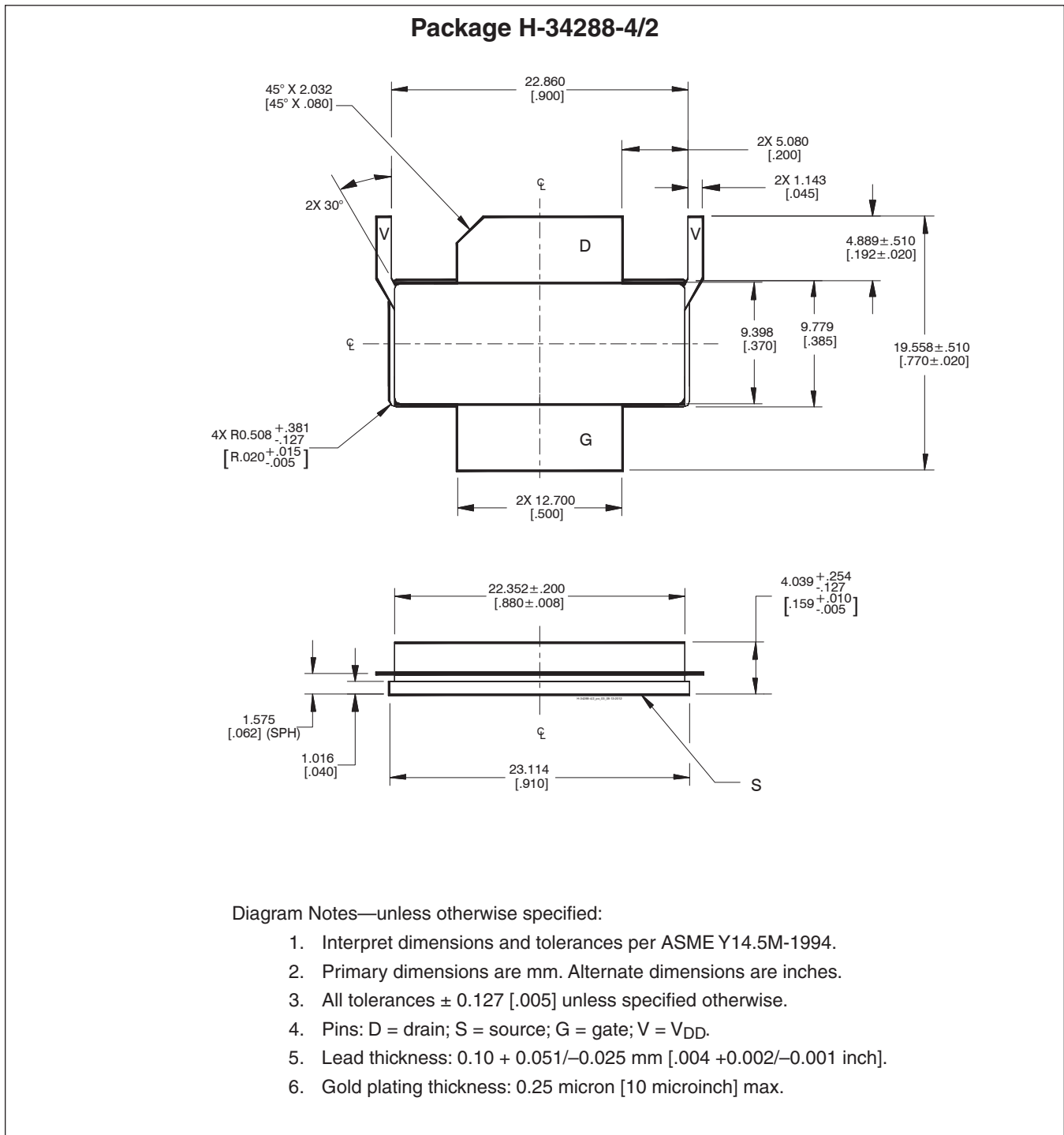

Revision History

Revision	Date	Data Sheet Type	Page	Subjects (major changes since last revision)
09.1	2016-06-13	Data Sheet	2	Updated ordering code to R0
10	06-12-2018	Production	All	Converted to Wolfspeed Data Sheet, Removed EL version

For more information, please contact:

4600 Silicon Drive
 Durham, North Carolina, USA 27703
www.wolfspeed.com/RF

Sales Contact
RFSales@wolfspeed.com

RF Product Marketing Contact
RFMarketing@wolfspeed.com
 919.407.7816

Notes

Disclaimer

Specifications are subject to change without notice. Cree, Inc. believes the information contained within this data sheet to be accurate and reliable. However, no responsibility is assumed by Cree for any infringement of patents or other rights of third parties which may result from its use. No license is granted by implication or otherwise under any patent or patent rights of Cree. Cree makes no warranty, representation or guarantee regarding the suitability of its products for any particular purpose. "Typical" parameters are the average values expected by Cree in large quantities and are provided for information purposes only. These values can and do vary in different applications and actual performance can vary over time. All operating parameters should be validated by customer's technical experts for each application. Cree products are not designed, intended or authorized for use as components in applications intended for surgical implant into the body or to support or sustain life, in applications in which the failure of the Cree product could result in personal injury or death or in applications for planning, construction, maintenance or direct operation of a nuclear facility.