

P/N AND WEEK/YEAR DATE CODE TO BE PRINTED ON SIDE OF COMPLETED CAGE ASSEMBLY APPROXIMATELY AS SHOWN. SEE TABLE BELOW FOR DATE CODE INFORMATION.

WEEK/YEAR DATE CODE TABLE	
WK	WEEK OF THE YEAR 01 THRU 52 (EXAMPLE: 01= FIRST WEEK OF YEAR 52= LAST WEEK OF YEAR
YR	22, 23, 24 ETC.. (EXAMPLE: YEAR 2022= 22)

NOTES:

- MATERIAL:  
CAGE: NICKEL PLATED COPPER ALLOY, THICKNESS 0.25mm.  
SPRING FINGER: STAINLESS STEEL.  
LIGHT PIPE COVER: NICKEL PLATED COPPER ALLOY.  
LIGHT PIPE: POLYCARBONATE (94-V0 RATED)
- PORTS ARE DESIGNED FOR SFP+ TRANSCEIVERS AND ARE COMPATIBLE WITH SFP TRANSCEIVERS.
- WELD SPOTS WILL SHOW SLIGHT DISCOLORATION.
- IT IS NOT RECOMMENDED TO PRESS ON LIGHT PIPES WHEN INSTALLING CAGE.
- NO RoHS EXEMPTIONS.

FUNCTIONAL SYMBOLS $F_A = 0$ $F_C = 0$ $F_P = 0$ DIVISIONAL SYMBOLS	THIS DRAWING CONTAINS INFORMATION THAT IS PROPRIETARY TO MOLEX ELECTRONIC TECHNOLOGIES, LLC AND SHOULD NOT BE USED WITHOUT WRITTEN PERMISSION	SCALE	CURRENT REV DESC: SEE REVISION TABLE		
	DIMENSION UNITS	3:1			
	GENERAL TOLERANCES (UNLESS SPECIFIED)				
	ANGULAR TOL	± 1.0°			
	4 PLACES	±	EC NO: 707054		
	3 PLACES	±	DRWN: PKH	2022/04/12	
	2 PLACES	± 0.15	CHK'D: TKUMARKC	2022/05/20	
	1 PLACE	± 0.25	APPR: SCHIEN	2022/05/23	
	0 PLACES	±	INITIAL REVISION:		
			DRWN: PKH	2022/04/12	
			APPR: SCHIEN	2022/05/23	
DRAFT WHERE APPLICABLE MUST REMAIN WITHIN DIMENSIONS	THIRD ANGLE PROJECTION	DRAWING	SERIES	MATERIAL NUMBER	CUSTOMER
		D-SIZE	100114	1001148903	
			DOCUMENT NUMBER	DOC TYPE	DOC PART
			1001148903	PSD	ASY
			REVISION		
			A		
			SHEET NUMBER	1 OF 5	

DOCUMENT STATUS	P1	RELEASE DATE	2022/05/23	11:20:24
-----------------	----	--------------	------------	----------

# PCB LAYOUT FOR SINGLE SIDED MOUNTING

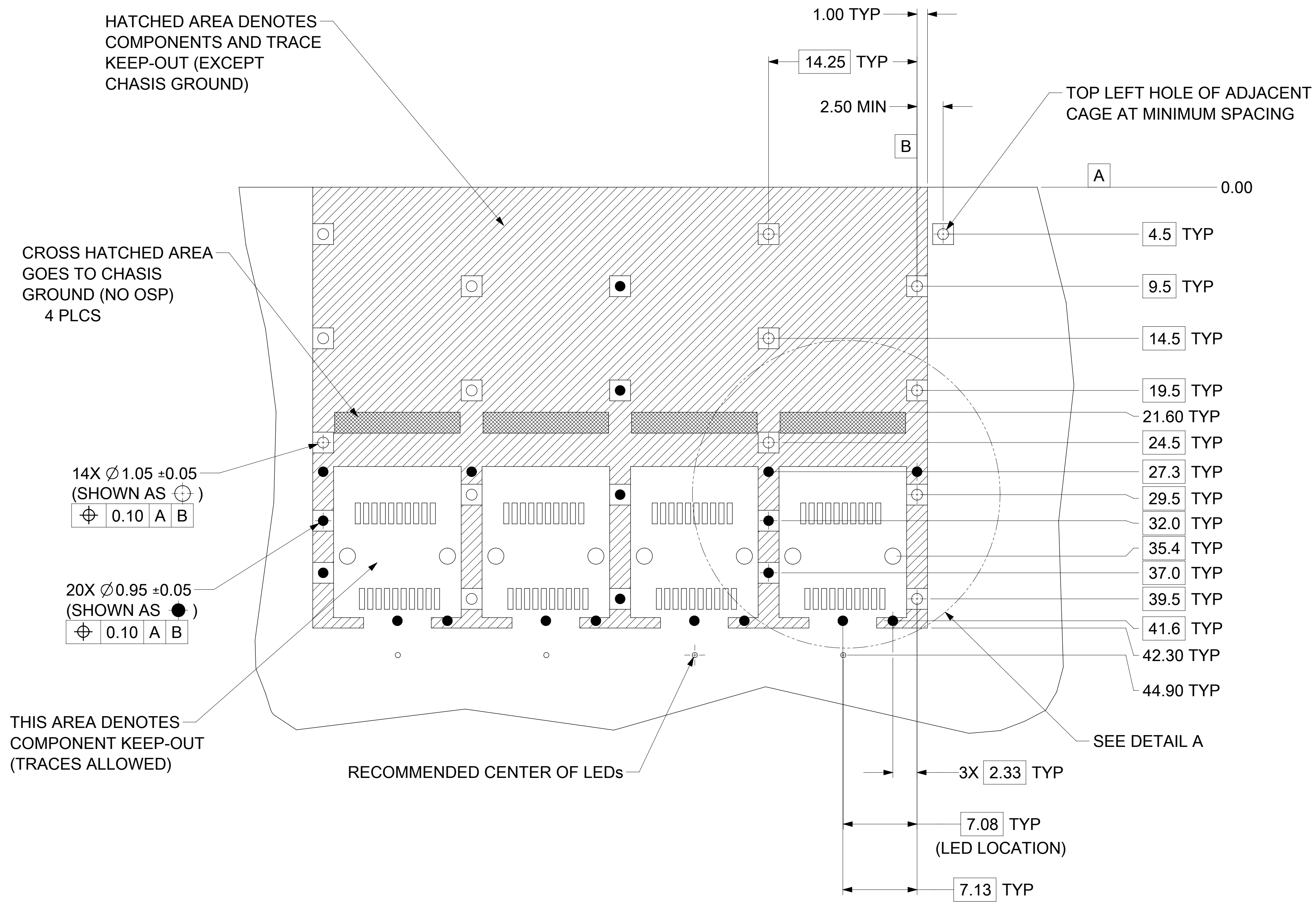

## HOST CONNECTOR DETAILS

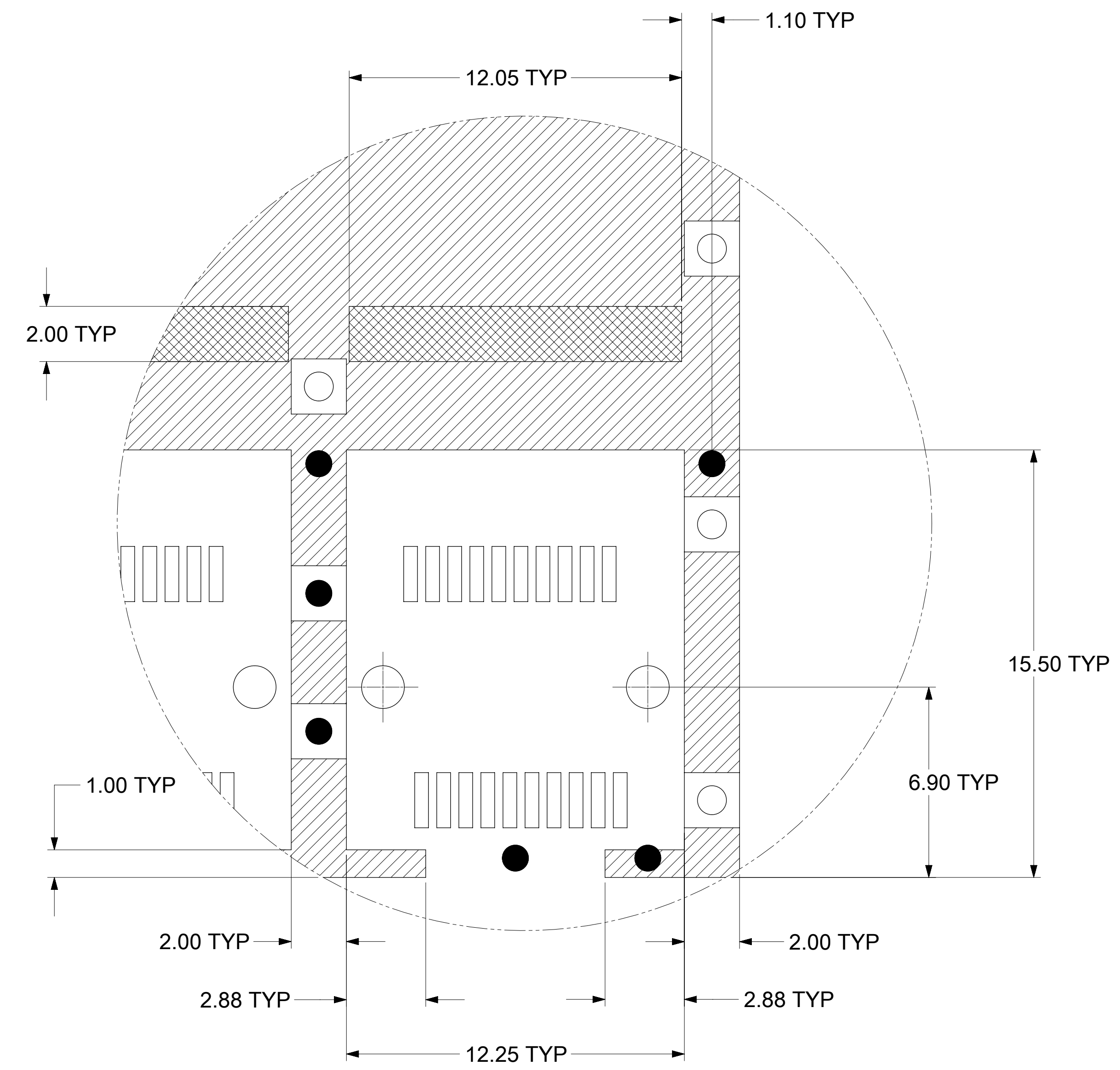

DETAIL A  
SCALE 8:1

LAYOUT APPLIES TO EACH PORT

### NOTES:

- PADS AND VIAS CONNECT TO CHASSIS GROUND (RECOMMEND PADS TO BE 2.00mm SQUARE)
- RECOMMENDED THRU HOLE PLATING INCLUDES HASL, OSP, OR IMMERSION (GOLD, SILVER, OR TIN).
- CONNECTOR PAD LAYOUT PER SFP+ MSA WILL ACCOMMODATE MOLEX CONNECTOR SERIES 170382. OR EQUIVALENT.
- HOLE PATTERN REPEATS FOR EACH PORT. SPACING BETWEEN PORTS IS 14.25mm.
- 1.57 MINIMUM PCB THICKNESS FOR SINGLE SIDED MOUNTING USE.

FUNCTIONAL SYMBOLS	THIS DRAWING CONTAINS INFORMATION THAT IS PROPRIETARY TO MOLEX ELECTRONIC TECHNOLOGIES, LLC AND SHOULD NOT BE USED WITHOUT WRITTEN PERMISSION		CURRENT REV DESC: SEE REVISION TABLE		
	FA = 0	mm	SCALE	4:1	
DIVISIONAL SYMBOLS	GENERAL TOLERANCES (UNLESS SPECIFIED)		EC NO: 707054		DRWN: PKH 2022/04/12 CHK'D: TKUMARKC 2022/05/20 APPR: SCHIEN 2022/05/23
	FC = 0	ANGULAR TOL $\pm 1.0^\circ$		INITIAL REVISION:	
DIVISIONAL SYMBOLS	FP = 0	4 PLACES	$\pm$	DRWN: PKH 2022/04/12	DOCUMENT NUMBER <b>1001148903</b>
		3 PLACES	$\pm$	APPR: SCHIEN 2022/05/23	
		2 PLACES	$\pm 0.15$	DRWN: PKH 2022/04/12	DOC PART
		1 PLACE	$\pm 0.25$	APPR: SCHIEN 2022/05/23	REVISION
	0 PLACES	$\pm$			PSD ASY A
DRAFT WHERE APPLICABLE MUST REMAIN WITHIN DIMENSIONS		THIRD ANGLE PROJECTION		DRAWING	SHEET NUMBER
				D-SIZE	2 OF 5
				SERIES	
				100114	
				MATERIAL NUMBER	
				1001148903	
				CUSTOMER	

# PCB LAYOUT FOR BELLY TO BELLY MOUNTING

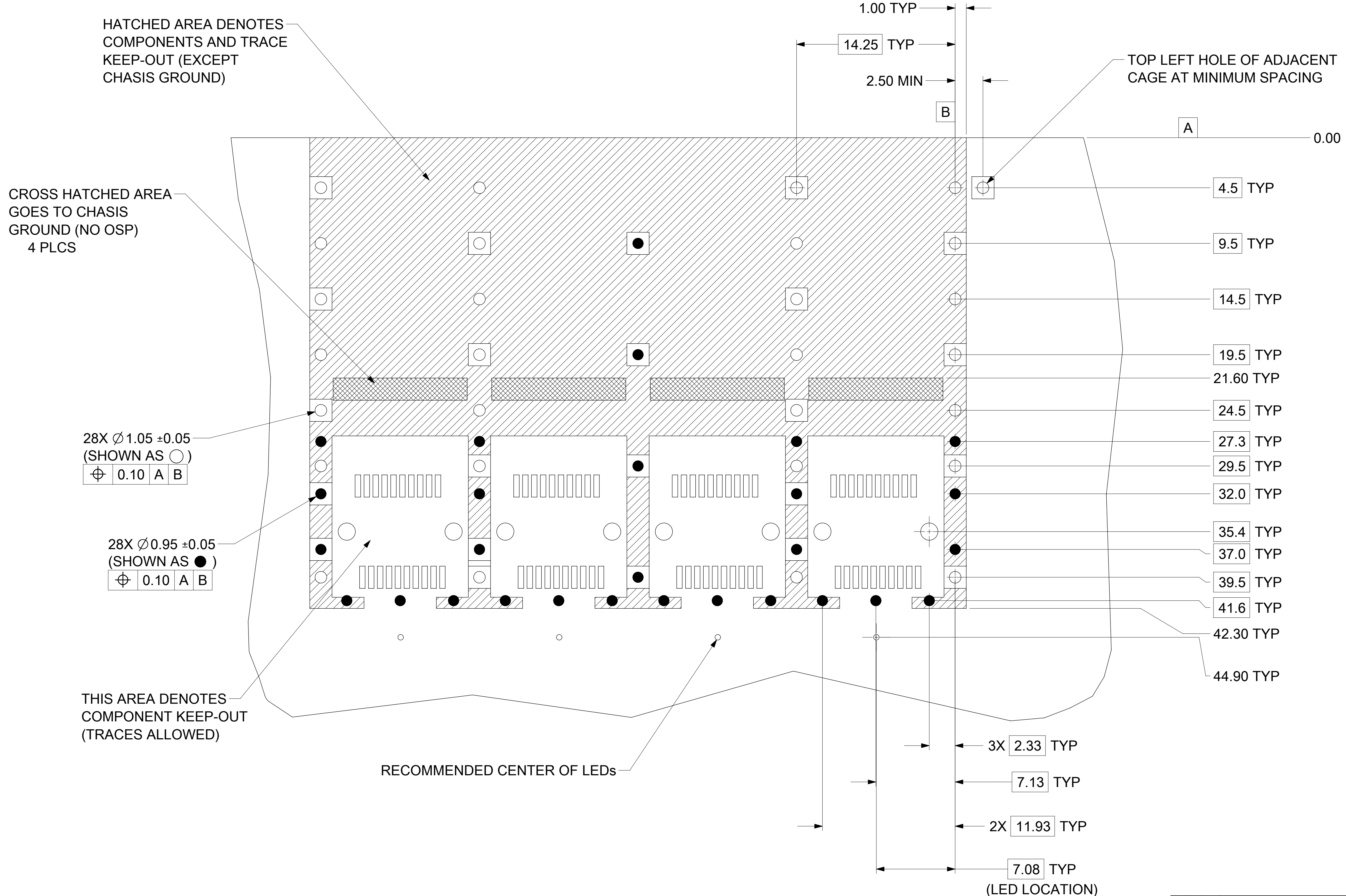

**NOTE:**  
SEE SHEET 2 FOR  
HOST CONNECTOR DETAIL  
AND LED LOCATION DETAILS

**NOTES:**

1. PADS AND VIAS CONNECT TO CHASSIS GROUND (RECOMMEND PADS TO BE 2.00mm SQUARE)
2. RECOMMENDED THRU HOLE PLATING INCLUDES HASL, OSP, OR IMMERSION (GOLD, SILVER, OR TIN).
3. CONNECTOR PAD LAYOUT PER SFP+ MSA WILL ACCOMMODATE MOLEX CONNECTOR SERIES 170382. OR EQUIVALENT.
4. HOLE PATTERN REPEATS FOR EACH PORT. SPACING BETWEEN PORTS IS 14.25mm.
5. 3.00 MINIMUM PCB THICKNESS FOR BELLY TO BELLY USE.

FUNCTIONAL SYMBOLS	THIS DRAWING CONTAINS INFORMATION THAT IS PROPRIETARY TO MOLEX ELECTRONIC TECHNOLOGIES, LLC AND SHOULD NOT BE USED WITHOUT WRITTEN PERMISSION		CURRENT REV DESC: SEE REVISION TABLE		
	DIMENSION UNITS	SCALE			
$F_A = 0$	mm	5:1			EC NO: 707054 DRWN: PKH 2022/04/12 CHK'D: TKUMARKC 2022/05/20 APPR: SCHIEN 2022/05/23
$F_C = 0$	GENERAL TOLERANCES (UNLESS SPECIFIED)				
$F_D = 0$	ANGULAR TOL ± 1.0°				INITIAL REVISION: DRWN: PKH 2022/04/12 APPR: SCHIEN 2022/05/23
DIVISIONAL SYMBOLS	4 PLACES	±			
	3 PLACES	±			
	2 PLACES	± 0.15			
	1 PLACE	± 0.25			
	0 PLACES	±			
DRAFT WHERE APPLICABLE MUST REMAIN WITHIN DIMENSIONS		THIRD ANGLE PROJECTION	DRAWING	SERIES	DOCUMENT NUMBER: 1001148903 DOC TYPE: PSD DOC PART: ASY REVISION: A
			D-SIZE	100114	MATERIAL NUMBER: 1001148903 CUSTOMER:
					SHEET NUMBER: 3 OF 5

DOCUMENT STATUS	P1	RELEASE DATE	2022/05/23 11:20:24
-----------------	----	--------------	---------------------

## BEZEL AND BOARD POSITION DIMENSIONS FOR SINGLE SIDE MOUNTING

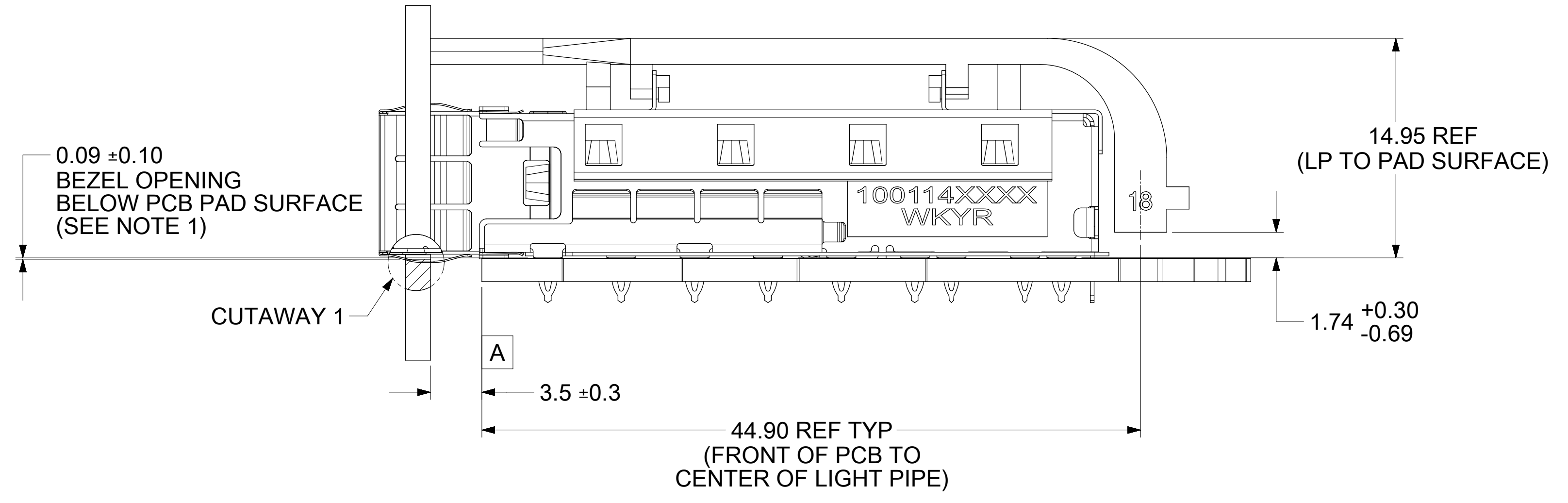
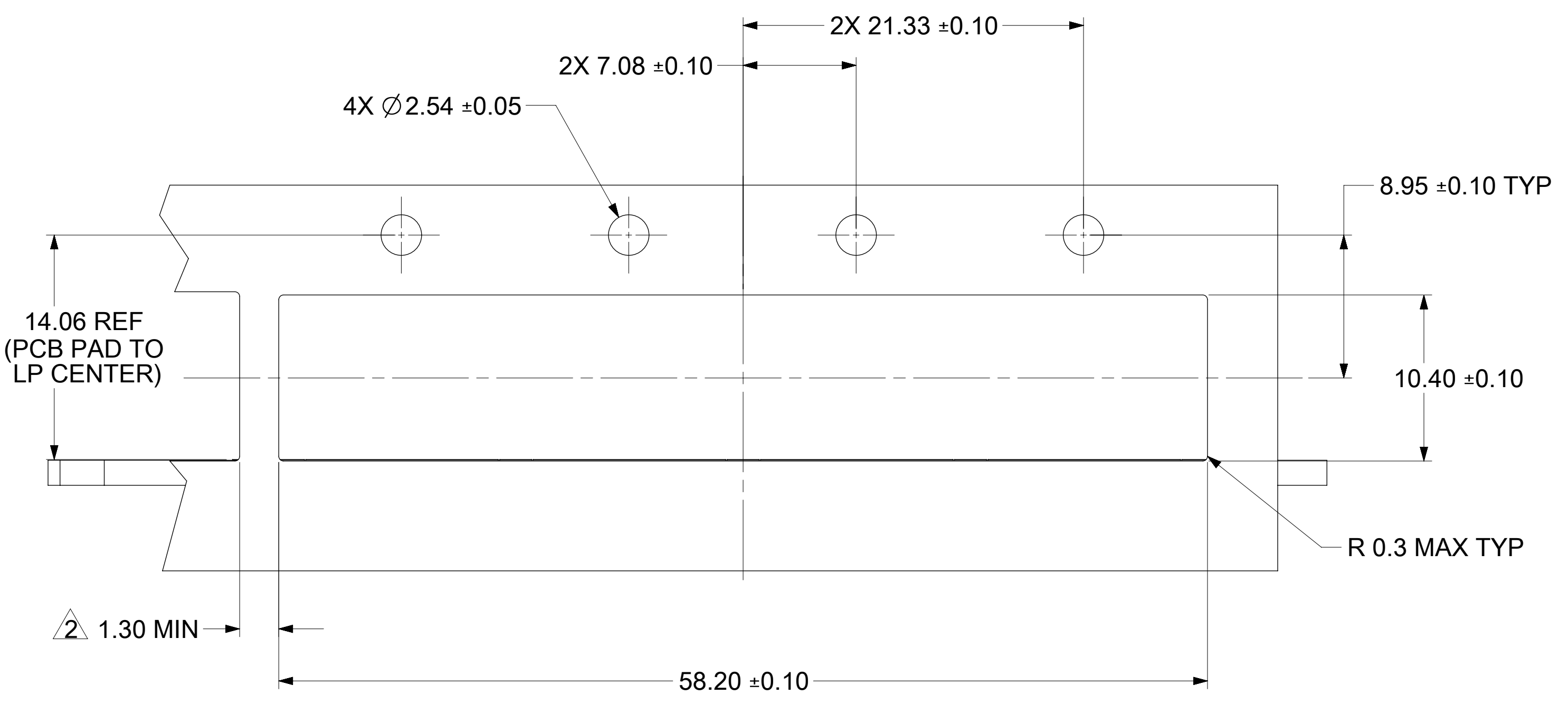

## BEZEL AND BOARD POSITION DIMENSIONS FOR BELLY TO BELLY MOUNTING

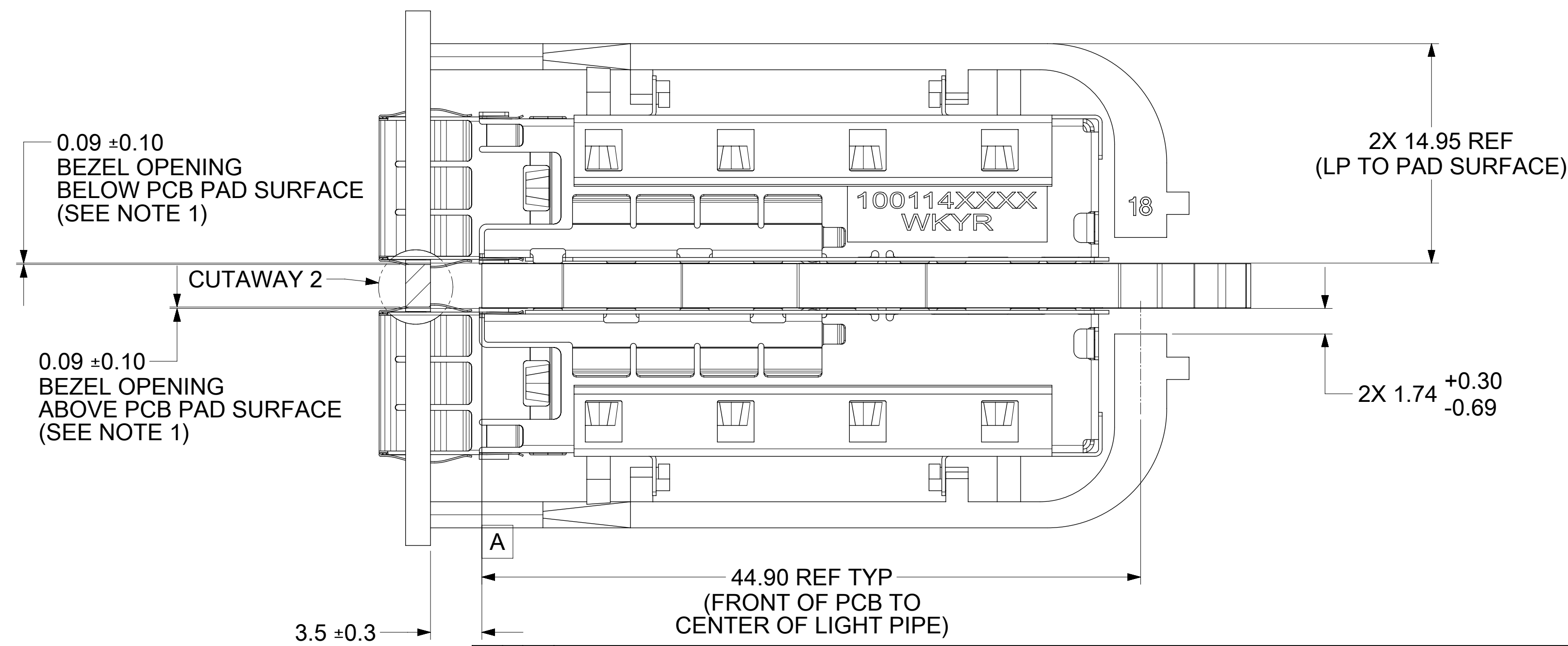
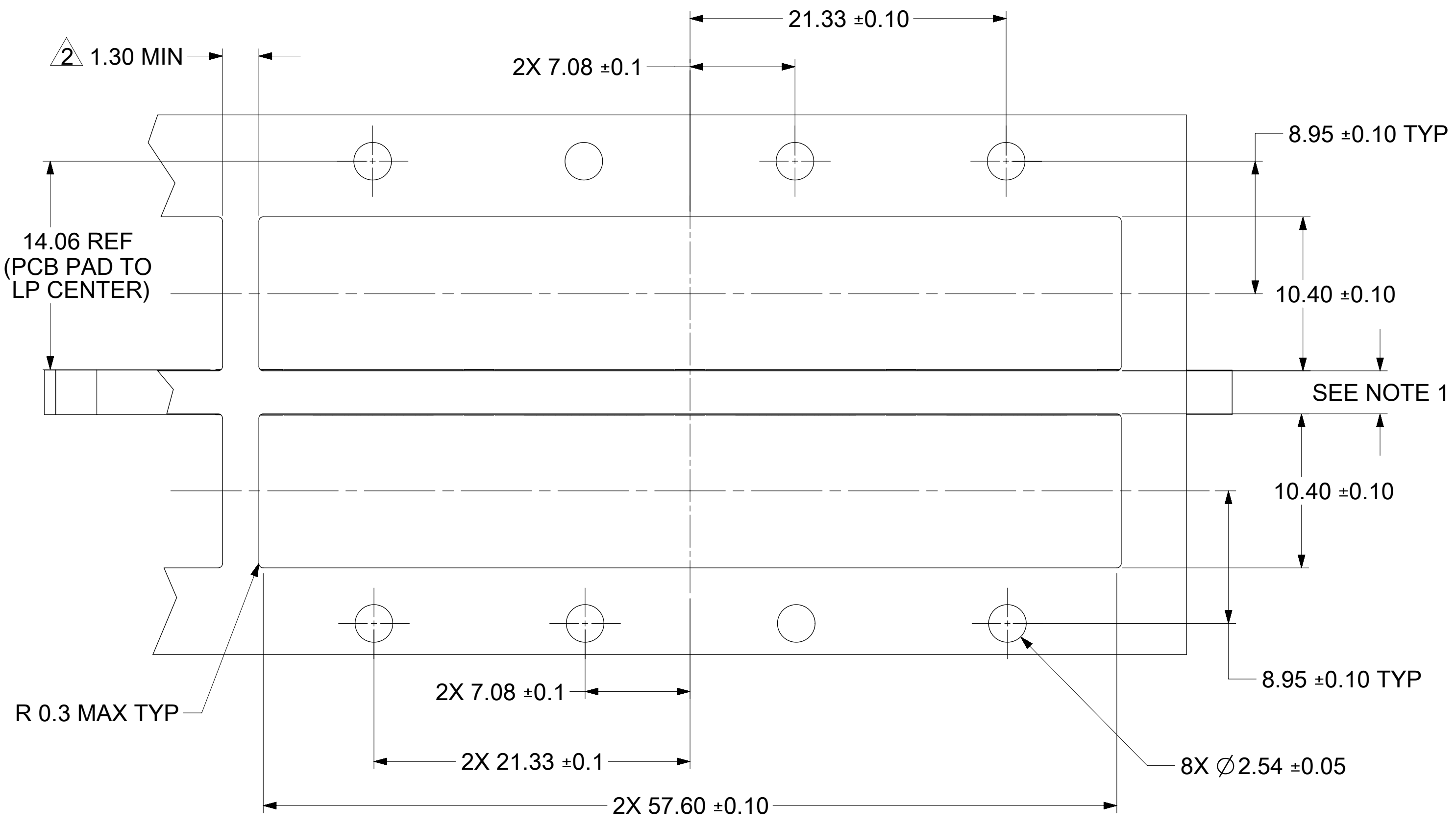

**NOTE:**  
 1. PCB THICKNESS VARIATION MUST BE CONSIDERED WHEN DETERMINING BEZEL OPENING, SIZE, AND LOCATION  
 2. THIS DIMENSION IS FOR REFERENCE ONLY. USER CAN MODIFY IT DEPENDS ON APPLICATION.  
 (THIS DIMENSION VARIES BASED ON DISTANCE OF "HOLE OF ADJACENT CAGE" ON PCB LAYOUT.)

<b>FUNCTIONAL SYMBOLS</b>	THIS DRAWING CONTAINS INFORMATION THAT IS PROPRIETARY TO MOLEX ELECTRONIC TECHNOLOGIES, LLC AND SHOULD NOT BE USED WITHOUT WRITTEN PERMISSION		
$\nabla_A = 0$	<b>DIMENSION UNITS</b>	<b>SCALE</b>	<b>CURRENT REV DESC:</b> SEE REVISION TABLE
$\nabla_C = 0$	mm	4:1	
$\nabla_P = 0$	<b>GENERAL TOLERANCES (UNLESS SPECIFIED)</b>		
	ANGULAR TOL	± 1.0°	
<b>DIVISIONAL SYMBOLS</b>	4 PLACES	±	EC NO: 707054
	3 PLACES	±	DRWN: PKH 2022/04/12
	2 PLACES	± 0.15	CHK'D: TKUMARKC 2022/05/20
	1 PLACE	± 0.25	APPR: SCHIEN 2022/05/23
	0 PLACES	±	INITIAL REVISION:
			DRWN: PKH 2022/04/12
			APPR: SCHIEN 2022/05/23
DRAFT WHERE APPLICABLE MUST REMAIN WITHIN DIMENSIONS		THIRD ANGLE PROJECTION	DRAWING SERIES
			<b>D-SIZE</b> 100114
			MATERIAL NUMBER CUSTOMER
			1001148903
			SHEET NUMBER
			4 OF 5

REV	DATE	DESCRIPTION
A	2022/05/20	INITIAL RELEASE

FUNCTIONAL SYMBOLS										THIS DRAWING CONTAINS INFORMATION THAT IS PROPRIETARY TO MOLEX ELECTRONIC TECHNOLOGIES, LLC AND SHOULD NOT BE USED WITHOUT WRITTEN PERMISSION									
FA = 0		mm		SCALE 1:1		CURRENT REV DESC: SEE REVISION TABLE						 ZSFP+ GEN2 1X4 CAGE ASSY PRESS FIT TYPE, W/SUS SF,UNDERBELLY GASKET & SINGLE LIGHT PIPE							
FC = 0		GENERAL TOLERANCES (UNLESS SPECIFIED)				EC NO: 707054													
FP = 0		ANGULAR TOL ± 1.0°				DRWN: PKH 2022/04/12													
DIVISIONAL SYMBOLS		4 PLACES ±		CHK'D: TKUMARKC 2022/05/20															
		3 PLACES ±		APPR: SCHIEN 2022/05/23															
		2 PLACES ± 0.15		INITIAL REVISION:															
		1 PLACE ± 0.25		DRWN: PKH 2022/04/12															
		0 PLACES ±		APPR: SCHIEN 2022/05/23															
DRAFT WHERE APPLICABLE MUST REMAIN WITHIN DIMENSIONS				THIRD ANGLE PROJECTION		DRAWING		SERIES		DOCUMENT NUMBER		DOC TYPE		DOC PART		REVISION			
D-SIZE				100114		1001148903		CUSTOMER		1001148903		PSD		ASY		A			
SHEET NUMBER				5 OF 5															