

## Applications

- Mobile phones / Smart phones
- Portable Media Players (PMPs)
- Portable Navigation Devices (PNDs)
- Notebooks / Netbooks / Media Tablets
- Digital Photo/Media Frames
- FM transmitters for Music Players

## Features

- Low cost single package Internal SMD FM Antenna Module
- Low 1.5mm height for thin devices
- High performance
- Easily interfaced to any FM receiver
- Transmit + Receive through single line
- Built-in ESD protection  $\pm 20\text{kV}$  (contact)
- Easy to integrate
- Intended for SMD mounting

## Product Description

Antenova's M10385 is an internal FM antenna module designed to address the growing market for FM Radio functionality in mobile devices such as mobile phones, PNDs, PMPs, Digital Photo Frames and Media Tablets. Antenova's innovative printed circuit board (PCB) internal antenna module design enables effective wireless FM radio transmit/receive function without the need for an external headset antenna or unsightly external retractable antenna.

The M10385 is an active antenna module consisting of Antenova's patent pending FM antenna with a matching circuit and low noise amplifier (LNA) in a small 30 x 5mm package, with the convenience of a standard surface mount device (SMD).

The M10385 is capable of transmitting/receiving FM frequencies from 87.5 - 108 MHz and is intended to be planar mounted at the edge of the host PCB for minimum PCB space requirement. A minimum clearance of 2mm between the antenna and the host PCB ground plane is recommended for the best FM signal reception.

## RF Antenna Module Block Diagram

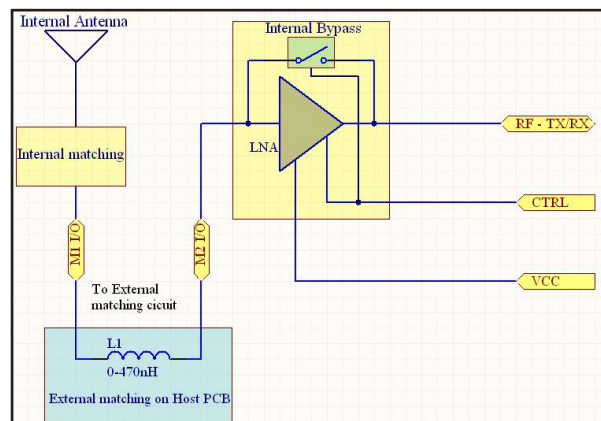

## Package Style

30 x 5 x 1.5mm FM Antenna Module

Top View - Antenna Side



Bottom View



Typical Mount

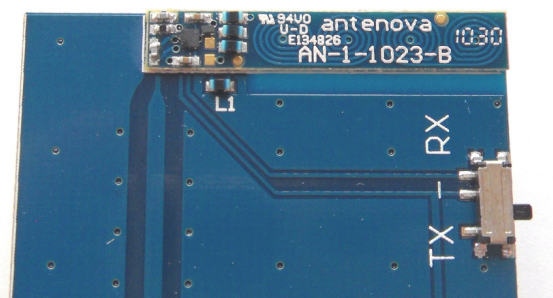

## Absolute Maximum Ratings

Symbol	Parameter	Min	Max	Unit
$V_{CC}$	Supply Voltage	-	3.6	V
$V_{CTL}$	RTC LDO Voltage Supply	-	3.6	V
RFin	RF Input Power	-	15	dBm
ESD	Electrostatic Discharge Immunity	-20	+20	kV
$P_{IN}$	Input Power (TX mode)	-	15	dBm

\* Exposure to absolute ratings may adversely affect reliability and may cause permanent damage.

## Recommended Operating Conditions

Symbol	Parameter	Min	Typ	Max	Unit
$T_a$	Ambient Temperature	-30	+25	+85	°C
$V_{CC}$	Supply Voltage	2.3	2.8	3.3	V
$V_{CTL\ H}$	Mode Control Voltage High (RX)	1	-	3.3	V
$V_{CTL\ L}$	Mode Control Voltage Low (RX)	0	-	0.5	V
$P_{IN}$	Input Power (TX mode)	-	-	8	dBm

## DC Electrical Characteristics

Conditions:  $V_{CC} = 2.8V$ ,  $T_a = 25\ ^\circ C$

Symbol	Parameter	Typ	Unit
$I_{CC1}$	$V_{CTL} = 2.8V$ (RX mode)	5	mA
$I_{CC2}$	$V_{CTL} = 0.0V$ (TX mode)	1	$\mu A$
$I_{CTRL1}$	$V_{CTL} = 2.8V$ (RX mode)	40	$\mu A$
$I_{CTRL2}$	$V_{CTL} = 0.0V$ (TX mode)	1	$\mu A$

## RF Specifications

Conditions:  $V_{CC} = 2.8V$ ,  $T_a = 25\ ^\circ C$

Symbol	Parameter	Typ	Unit
$ANT_{EFF}^*$	Antenna Efficiency	-27	dB
NF	Noise Figure	1.5	dB
$G_{LNA}$	LNA Gain (RX mode)	13.5	dB

\*Not including Mismatch loss

## Electrical Performance

Condition: Tested on 100 x 40mm test board

### Return Loss of RF I/O (TX mode)

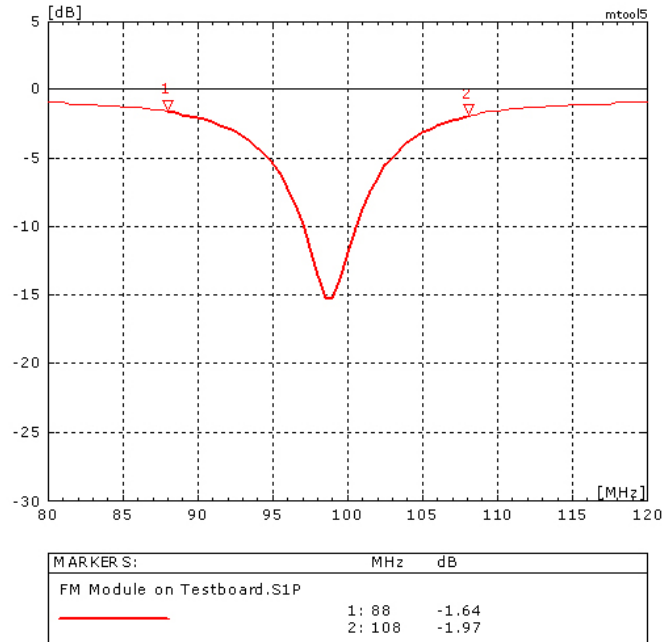

### Impedance of RF I/O (TX mode)

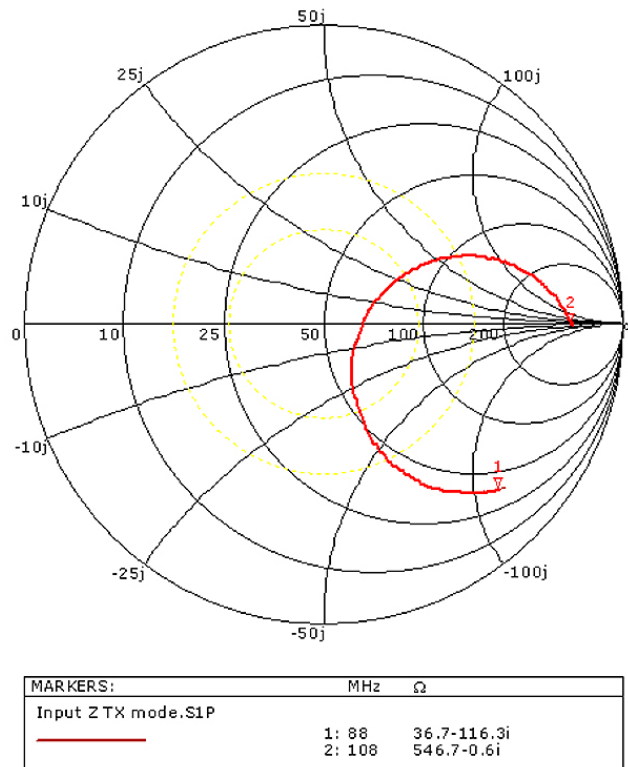

Impedance of RF I/O (RX mode)

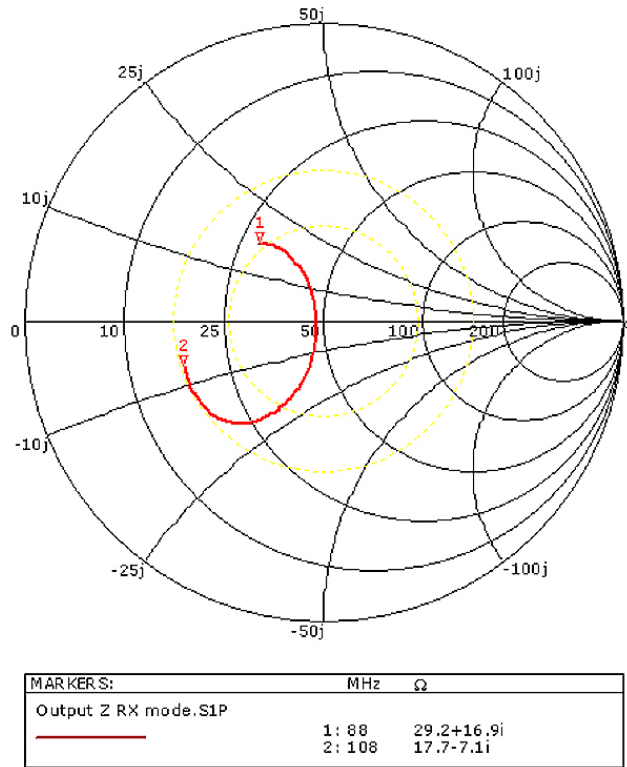

## Isolation

An example of Isolation between a GSM antenna mounted on a PCB with the FM module is shown in this S21 plot. The transmission measurement was taken at pad M1 on the FM module. In this example the results show that the FM module is immune from any effect of an active GSM antenna, maintaining at least -50dB isolation across all bands.

Note: Measured Isolation will depend on details of the placement of the cellular antenna with respect to the FM module.

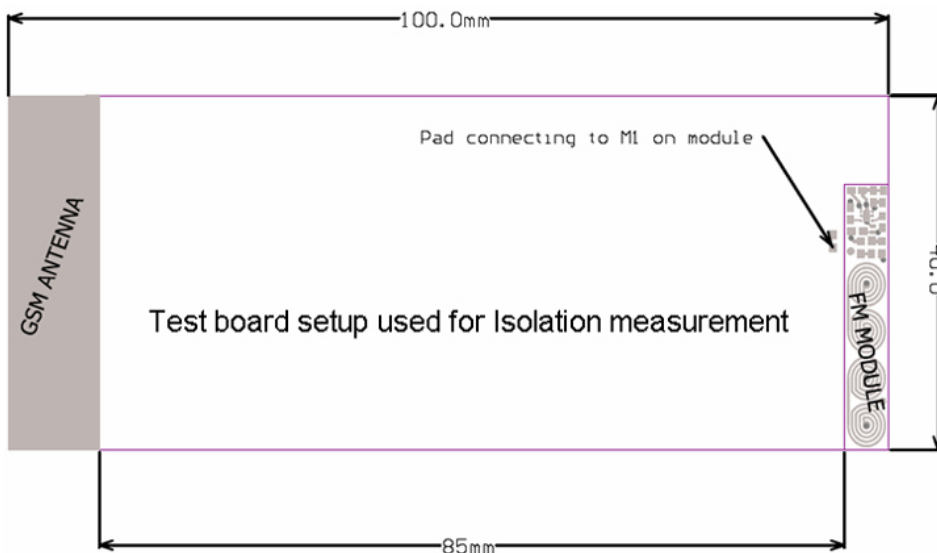
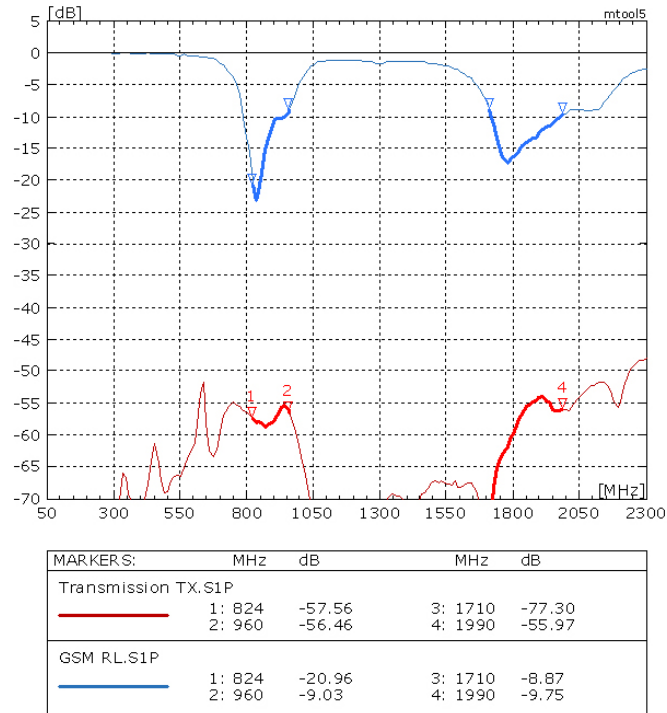

## Pin out Description

Pin	Name	I/O	Description
1	$V_{CTL}$	I	Control voltage to select operating mode. Pull high for RX and pull low for TX $V_{CTL}$ is LOW when left unconnected due to pull down resistor on module
2,6,8	GND		Ground connections
3	$V_{CC}$	I	Power Supply
4	RF I/O	I/O	RF input/output for connection to FM receiver/transmitter chip
5	M1	I/O	Pad to external matching component
7	M2	I/O	Pad to external matching component
9, 10, 11, 12, 13, 14, 15, 16	Support Pads		Floating pads for mechanical support and alignment during reflow

## Recommended Application Schematic

The following schematic shows the recommended connection for the module.

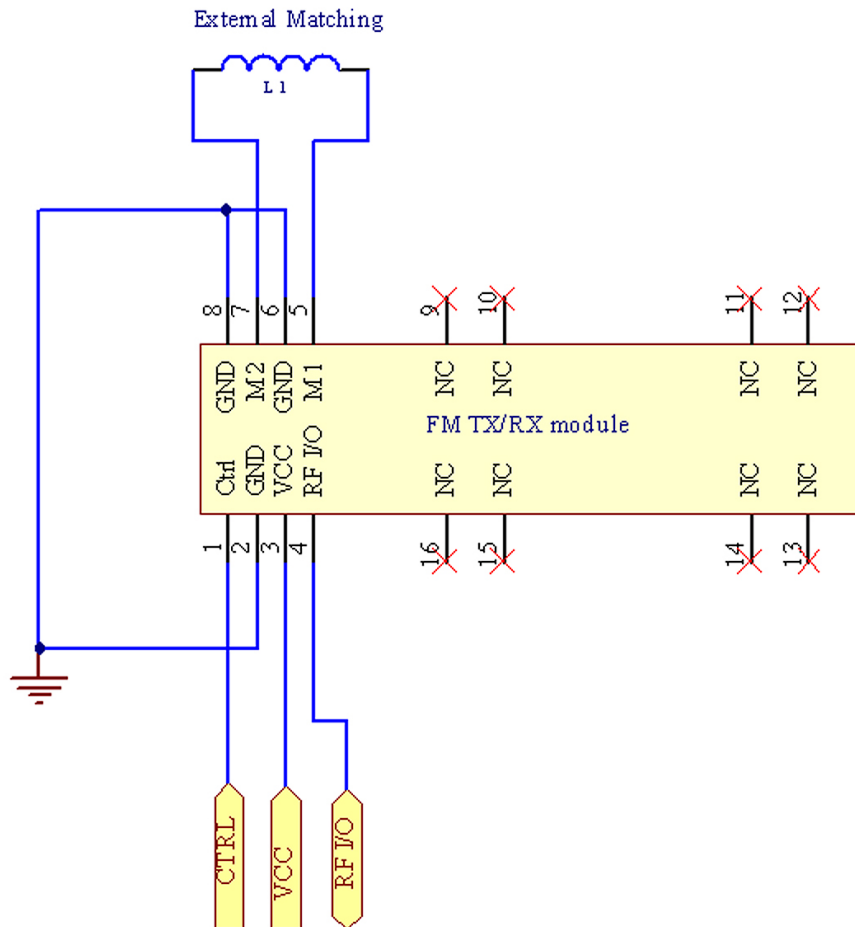

## Mechanical Drawings

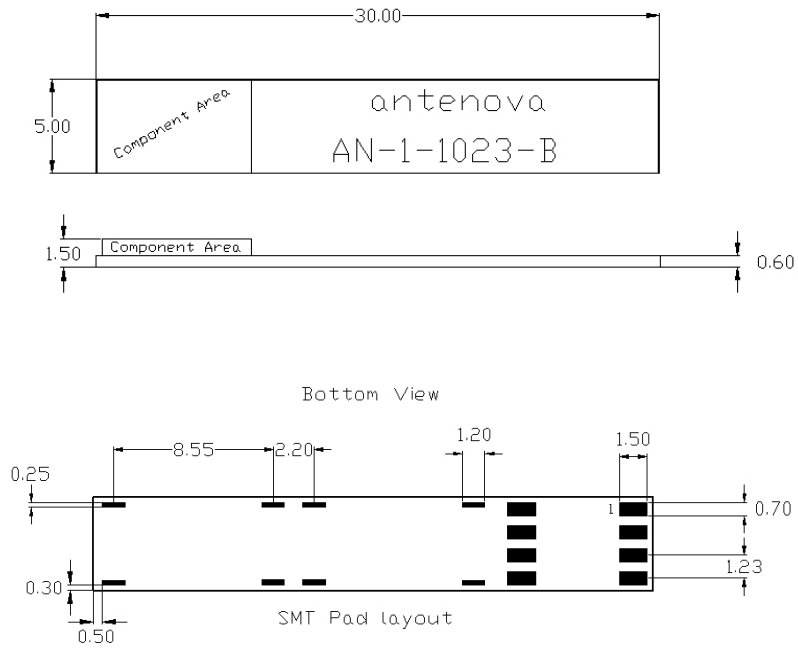

Notes: Units = mm

## Antenna Footprint

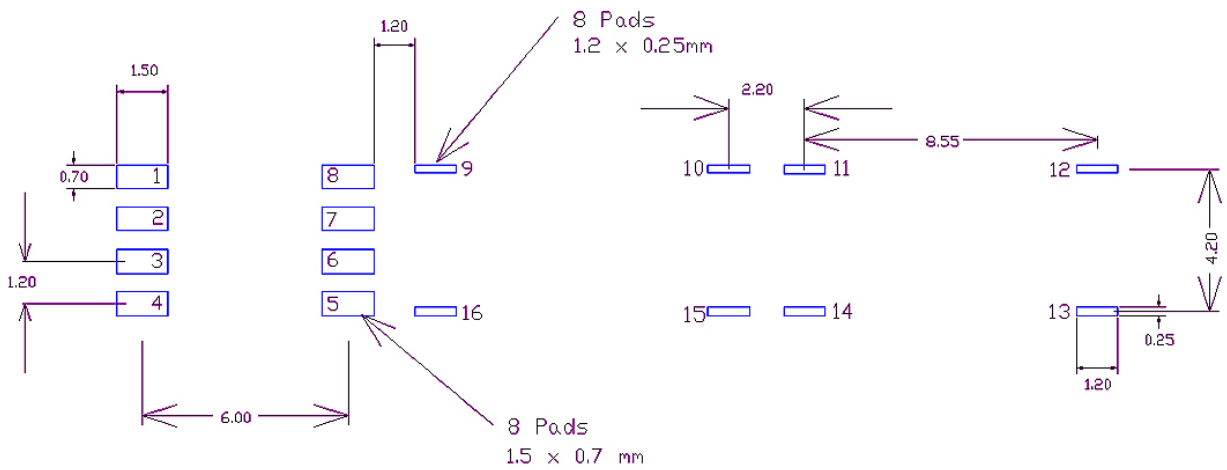

Land pattern for host PCB

## Matching Circuit

The antenna requires a matching circuit that must be optimized for each customer's product. The matching circuit will require one component and the following pad layout should be designed into the device so the correct circuit can be installed:

Example land pattern for module showing routing and position of matching component shown below:

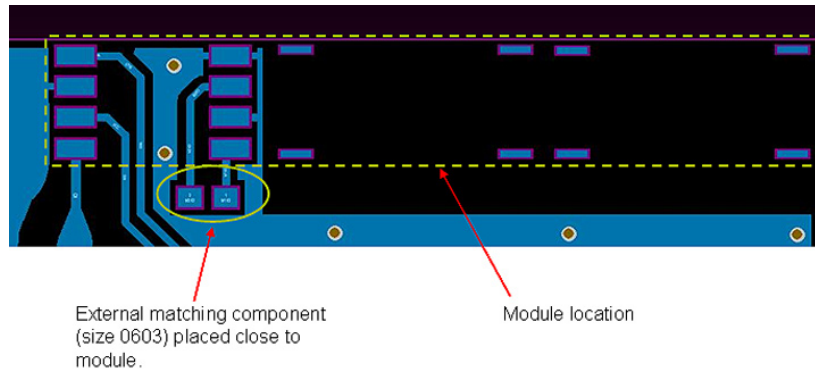

The module is externally matched with a single component:

- Component needs to be High Q wire wound inductor
- Size 0603
- Value range 0 - 470nH

Note: The precise value for the matching circuit component will vary depending on the size of the PCB, surrounding components and plastic case. The antenna should be measured before selecting suitable matching components. Antenova offers a matching service on request. Contact [info@antenova.com](mailto:info@antenova.com) for further information.

Matching may also be solved by performing an active listening test by tuning into FM broadcasts across the band, and score the quality of the stations in a listening test. Testing different values of Inductor (0-470nH) and increase or decrease the value according to the quality of reception. This is only a comparative test but can give a very accurate guide to the tuning if performed repeatedly in the same test conditions.

Gerber files of the module footprint are available from Antenova on request. Please contact [info@antenova.com](mailto:info@antenova.com) for further details.



## Typical FM Antenna Module Placement

The module must be placed to the edge of the host PCB with the ground plane removed from all layers under the antenna portion of the module (22 x 7mm). The recommended placements for optimal system performance are shown below for a 100 x 40mm standard reference board.

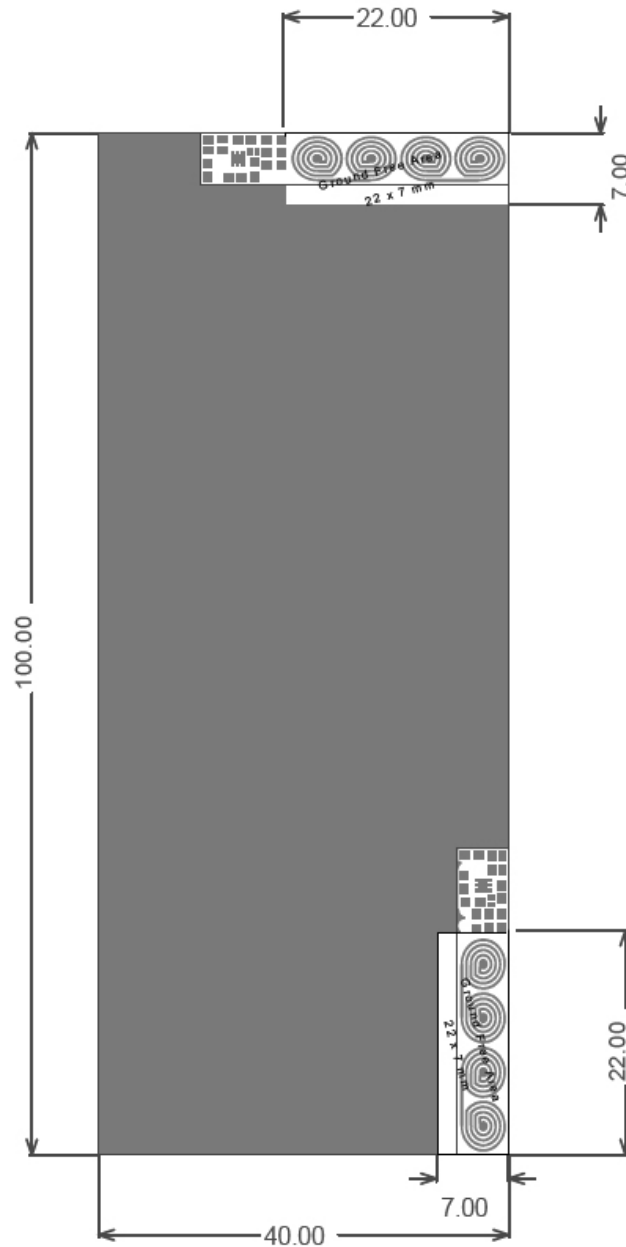

Notes: Units = mm

## Reference Boards

The reference boards have been designed for evaluation purposes of FM TX/RX and they include a SMA female connector. Reference board are available with a tuned module.

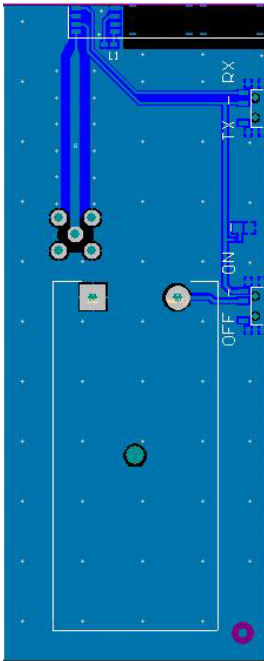

M10385-U1  
40 x 100 mm  
reference board

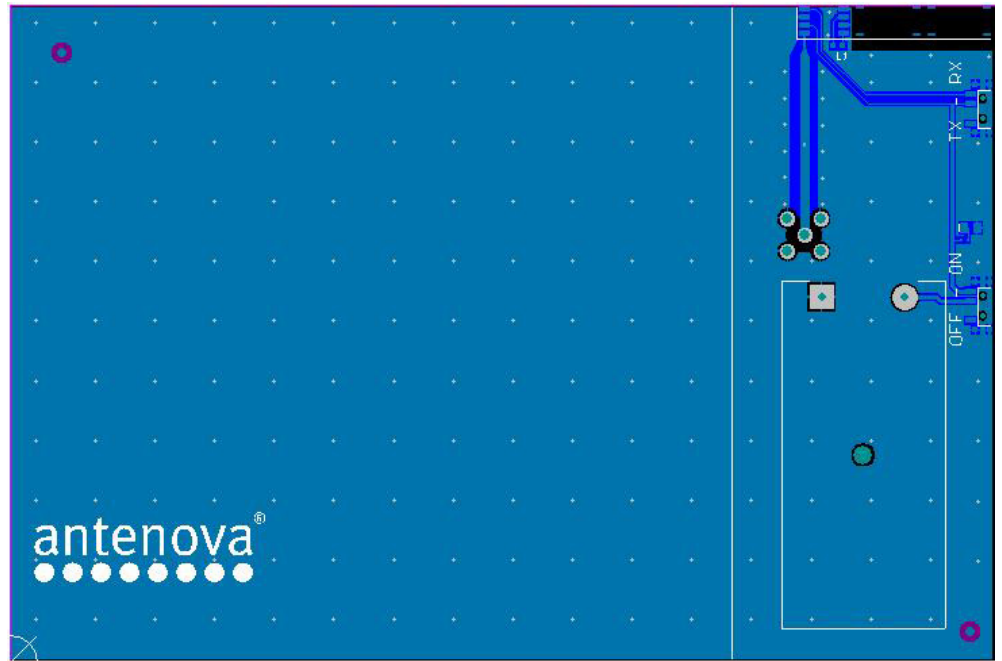

M10385-U2 100 x 150 mm reference board

Reference boards are available for typical applications. Contact [info@antenna.com](mailto:info@antenna.com) for further information or to order a reference board.

## Soldering

This antenna is suitable for lead free soldering. The reflow profile should be adjusted to suit the PCBA, oven and solder paste, while observing the following conditions:

- Peak temperature: 260°C or below
- Time at peak temperature : 10 seconds or less
- Time at temperature of 220°C or higher : 60 seconds or less
- Preheating time at 120 to 180°C : 120±30 seconds

## Hazardous material regulation conformance

M10385 FM antenna module has been tested to conform to RoHS requirements, and a certificate of conformance is available from Antenova. It is worth noting that the FR4 substrate also conforms to the IEC's definition of Halogen-free.



[www.antenova.com](http://www.antenova.com)

### Corporate Headquarters

#### Antenova Ltd.

Far Field House  
Albert Road  
Stow-cum-Quy  
Cambridge, CB25 9AR  
UK

**Tel:** +44 (0) 1223 810600  
**Fax:** +44 (0) 1223 810650  
**Email:** [sales@antenova.com](mailto:sales@antenova.com)

### USA Headquarters

#### Antenova USA

Rogers Business Park  
2541 Technology Drive, Suite 403  
Elgin, IL 60124  
USA

**Tel:** +1 (847) 551-9710  
**Fax:** +1 (847) 551-9719  
**Email:** [sales@antenova.com](mailto:sales@antenova.com)

### Asia Headquarters

#### Antenova Asia Ltd.

4F, No. 324, Sec. 1, Nei-Hu Road  
Nei-Hu District  
Taipei 11493  
Taiwan, ROC

**Tel:** +886 (0) 2 8797 8630  
**Fax:** +886 (0) 2 8797 6890  
**Email:** [sales@antenova.com](mailto:sales@antenova.com)

**Copyright® 2010 Antenova Ltd.** All Rights Reserved. Antenova® and RADIONOVA® are trademarks of Antenova Ltd. Any other names and/or trademarks belong to their respective companies.

The materials provided herein are believed to be reliable and correct at the time of print. Antenova does not warrant the accuracy or completeness of the information, text, graphics or other items contained within these information. Antenova further assumes no responsibility for the use of this information, and all such information shall be entirely at the user's risk.



Certificate No: 4598

Integrated Antenna and RF Solutions