

Analog Devices Welcomes Hittite Microwave Corporation

NO CONTENT ON THE ATTACHED DOCUMENT HAS CHANGED



THIS PAGE INTENTIONALLY LEFT BLANK

Typical Applications

The HMC543LC4B is ideal for:

- EW Receivers
- Weather & Military Radar
- Satellite Communications
- Beamforming Modules

Features

- Low RMS Phase Error: 5°
- Low Insertion Loss: 6.5 dB
- Excellent Flatness
- 360° Coverage, LSB = 22.5°
- 24 Lead Ceramic SMT Package: 16mm²

Functional Diagram

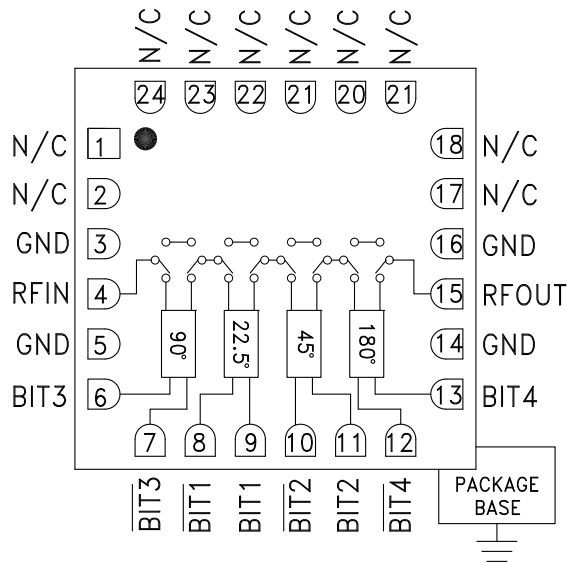

General Description

The HMC543LC4B is a 4-bit digital phase shifter which is rated from 8 to 12 GHz, providing 0 to 360 degrees of phase coverage, with a LSB of 22.5 degrees. The HMC543LC4B features very low RMS phase error of 5 degrees and extremely low insertion loss variation of ± 0.8 dB across all phase states. This high accuracy phase shifter is controlled with complementary logic of 0/-3V, and requires no fixed bias voltage. The HMC543LC4B is housed in a compact 4x4 mm ceramic leadless SMT package and is internally matched to 50 Ohms with no external components. Simple external level shifting circuitry can be used to convert a positive CMOS control voltage into complementary negative control signals.

Electrical Specifications, $T_A = +25^\circ\text{C}$, 50 Ohm System, Control Voltage = 0/-3V

Parameter	Min.	Typ.	Max.	Units
Frequency Range	8		12	GHz
Insertion Loss*		6.5	8	dB
Input Return Loss*		10		dB
Output Return Loss*		10		dB
Phase Error*		± 10	± 15	deg
RMS Phase Error		5		deg
Gain Variation*		± 0.8		dB
Input Power for 1 dB Compression	21	24.5		dBm
Input Third Order Intercept		40		dBm
Control Voltage Current		0.4		μA

*Note: All States Shown

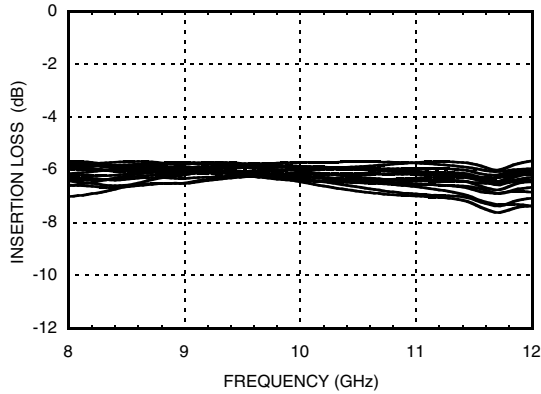
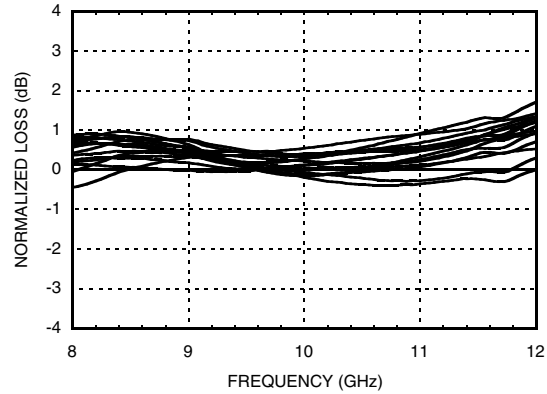
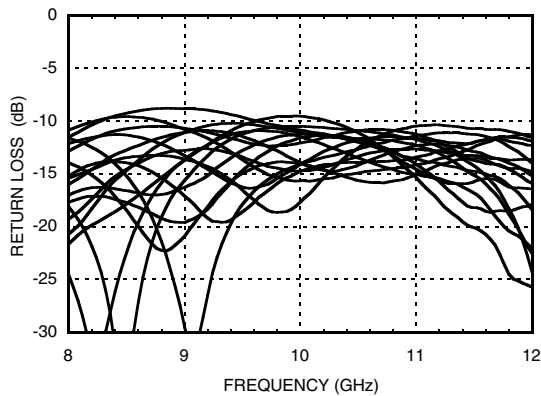
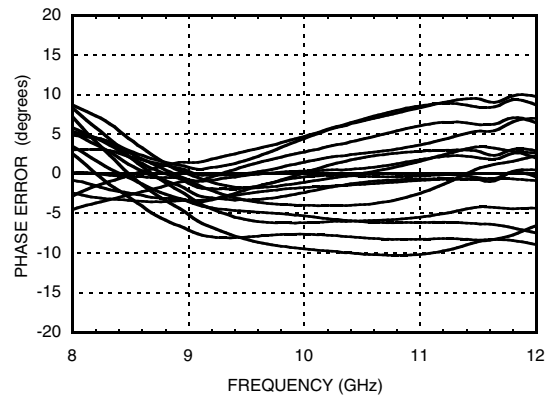
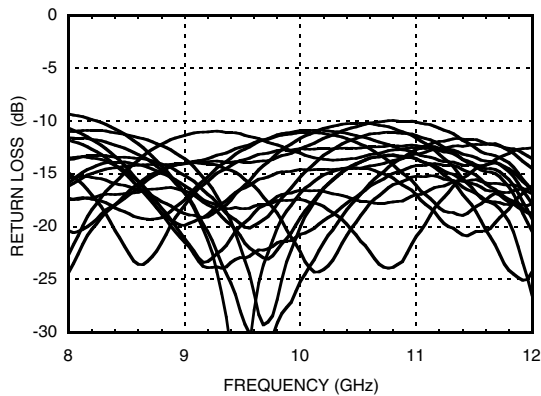
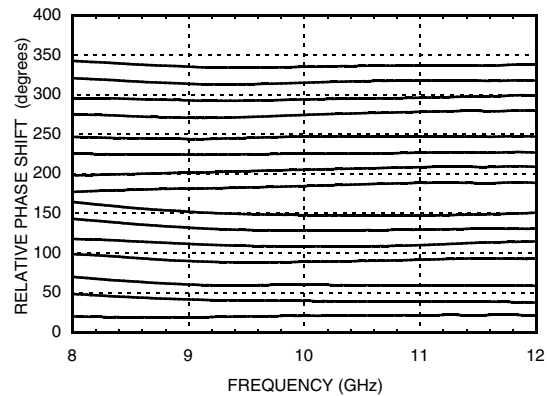
Insertion Loss, All States

Normalized Loss, All States

Input Return Loss, All States

Phase Error, All States

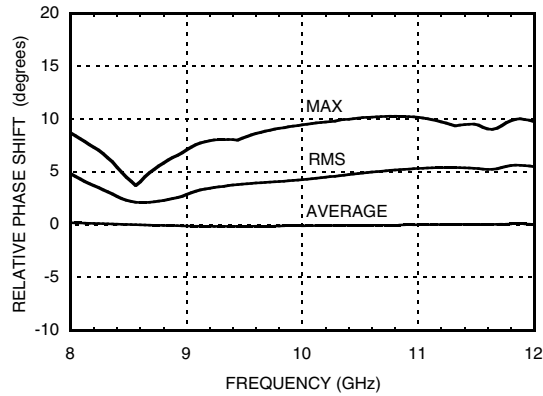
Output Return Loss, All States

Relative Phase Shift, All States



22.5° MMIC 4-BIT DIGITAL PHASE SHIFTER, 8 - 12 GHz

Relative Phase Shift, RMS, Average, Max, All States



Input IP3, All States

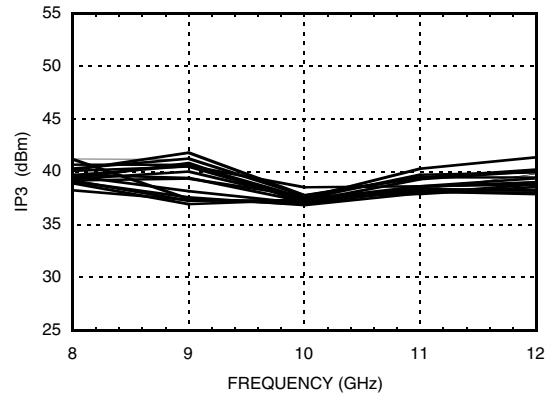

Input IP2, All States

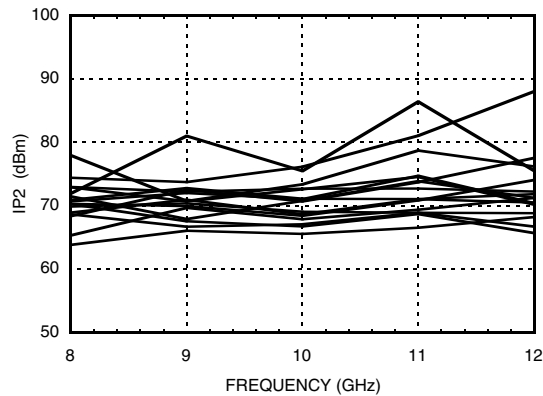

Input P1dB, All States

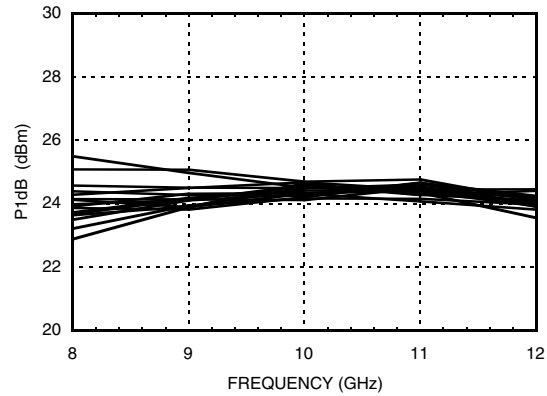

RMS Phase Error vs. Temperature

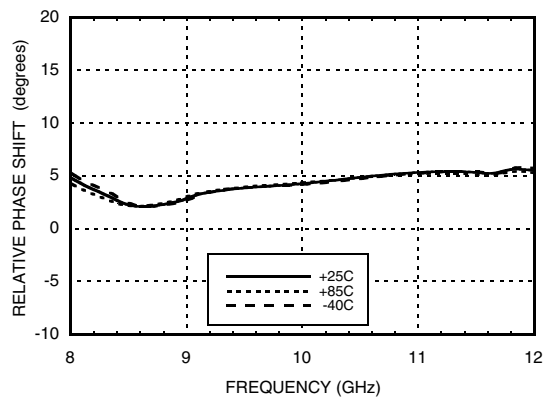

Insertion Temperature All States

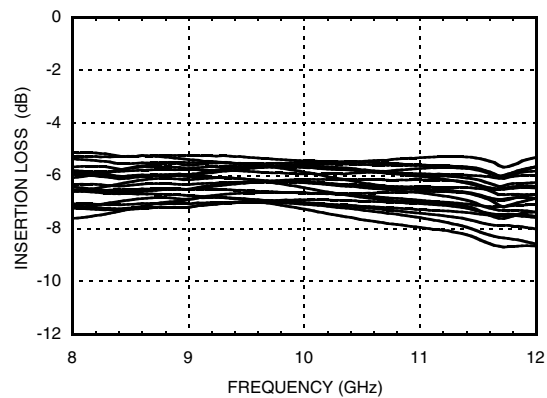



22.5° MMIC 4-BIT DIGITAL PHASE SHIFTER, 8 - 12 GHz

Phase Error vs. State

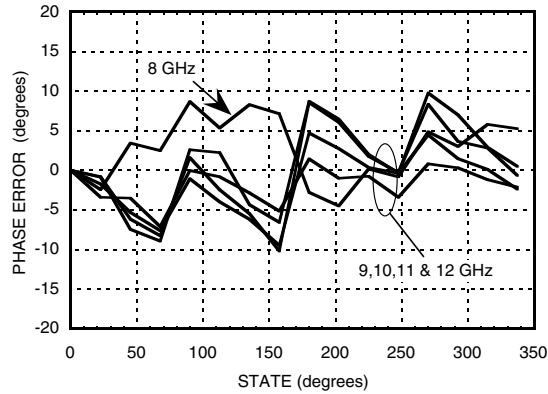

Control Voltage

State	Bias Condition
Low (0)	-2.5 to -3.5V @ 0.4 μ A Typ.
High (1)	0 to +0.3V @ 0.4 μ A Typ.

Absolute Maximum Ratings

Input Power (RFin) (8-12 GHz)	+27 dBm (T= +85 °C)
Channel Temperature (Tc)	150 °C
Thermal Resistance (channel to ground paddle)	130 °C/W
Storage Temperature	-65 to +150 °C
Operating Temperature	-40 to +85 °C



ELECTROSTATIC SENSITIVE DEVICE
OBSERVE HANDLING PRECAUTIONS

Truth Table

Control Voltage Input								Phase Shift (Degree) RFIN - RFOUT
Bit 1	$\overline{\text{Bit 1}}$	Bit 2	$\overline{\text{Bit 2}}$	Bit 3	$\overline{\text{Bit 3}}$	Bit 4	$\overline{\text{Bit 4}}$	
0	1	0	1	0	1	0	1	Reference
1	0	0	1	0	1	0	1	22.5
0	1	1	0	0	1	0	1	45.0
0	1	0	1	1	0	0	1	90.0
0	1	0	1	0	1	1	0	180.0
1	0	1	0	1	0	1	0	337.5

Any combination of the above states will provide a phase shift approximately equal to the sum of the bits selected.

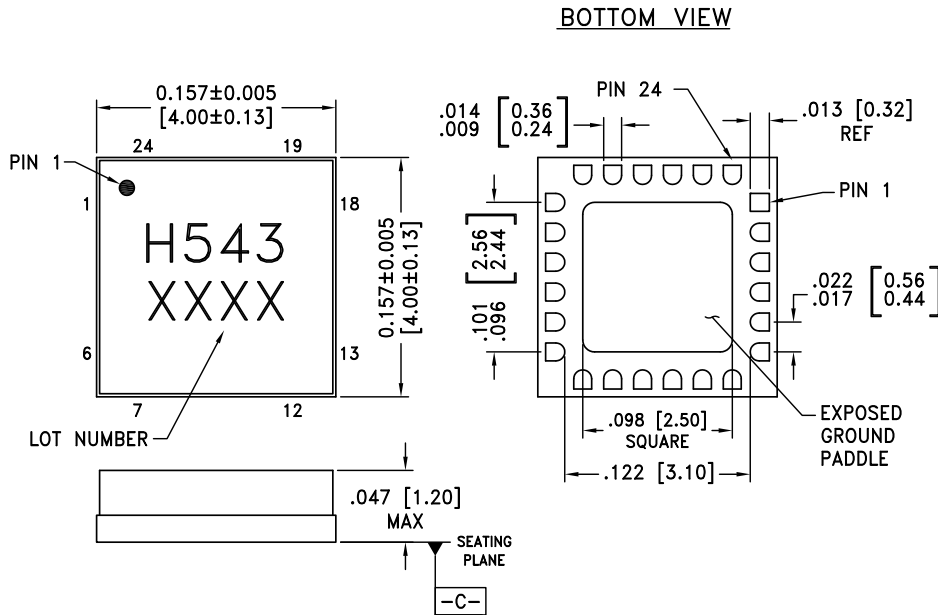
Outline Drawing

NOTES:

1. PACKAGE BODY MATERIAL: ALUMINA
2. LEAD AND GROUND PADDLE PLATING: 30-80 MICROINCHES GOLD OVER 50 MICROINCHES MINIMUM NICKEL.
3. DIMENSIONS ARE IN INCHES [MILLIMETERS].
4. LEAD SPACING TOLERANCE IS NON-CUMULATIVE
5. PACKAGE WARP SHALL NOT EXCEED 0.05mm DATUM [-C-]
6. ALL GROUND LEADS AND GROUND PADDLE MUST BE SOLDERED TO PCB RF GROUND..



Package Information

Part Number	Package Body Material	Lead Finish	MSL Rating	Package Marking ^[2]
HMC543LC4B	Alumina, White	Gold over Nickel	MSL3 ^[1]	H543 XXXX

[1] Max peak reflow temperature of 260 °C

[2] 4-Digit lot number XXXX

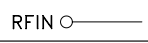
Pin Descriptions

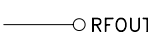
Pin Number	Function	Description	Interface Schematic
1, 2, 17 - 24	N/C	No connection required. These pins may be connected to RF/DC ground without affecting performance.	
3, 5, 14, 16	GND	These pins and exposed ground paddle must be connected to RF/DC ground.	
4	RFIN	This port is matched to 50 Ohms.	
6, 9, 11, 13	BIT3, BIT1, BIT2, BIT4	Non-Inverted Control Input. See truth table and control voltage tables.	
7, 8, 10, 12	$\overline{\text{BIT3}}, \overline{\text{BIT1}}$ $\overline{\text{BIT2}}, \overline{\text{BIT4}}$	Inverted Control Input. See truth table and control voltage tables.	
15	RFOUT	This port is matched to 50 Ohms.	

Application Circuit

This circuit converts a single line positive (0/+5V) control signal to complementary negative (0/-3V) control signals.

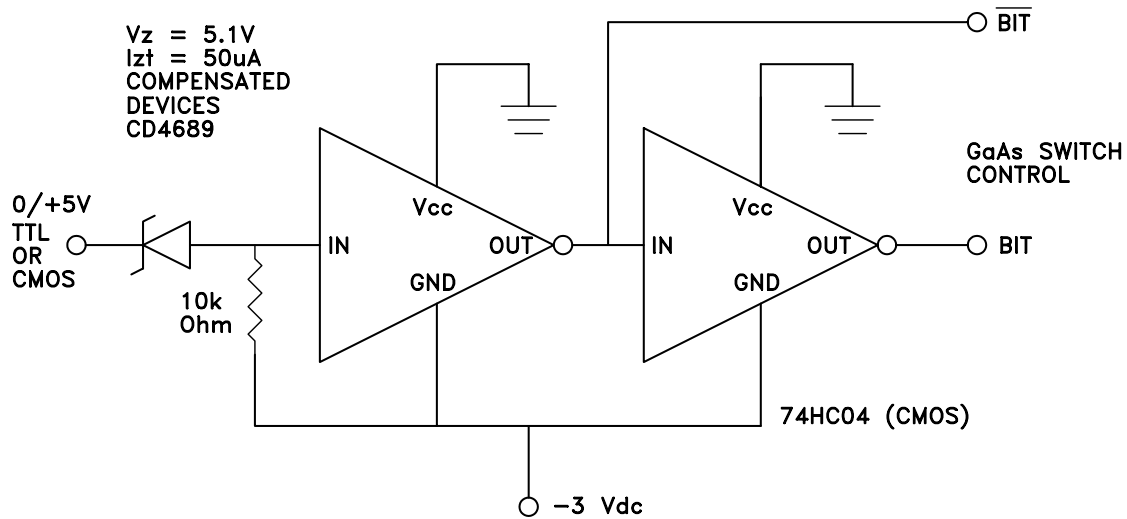

Evaluation PCB

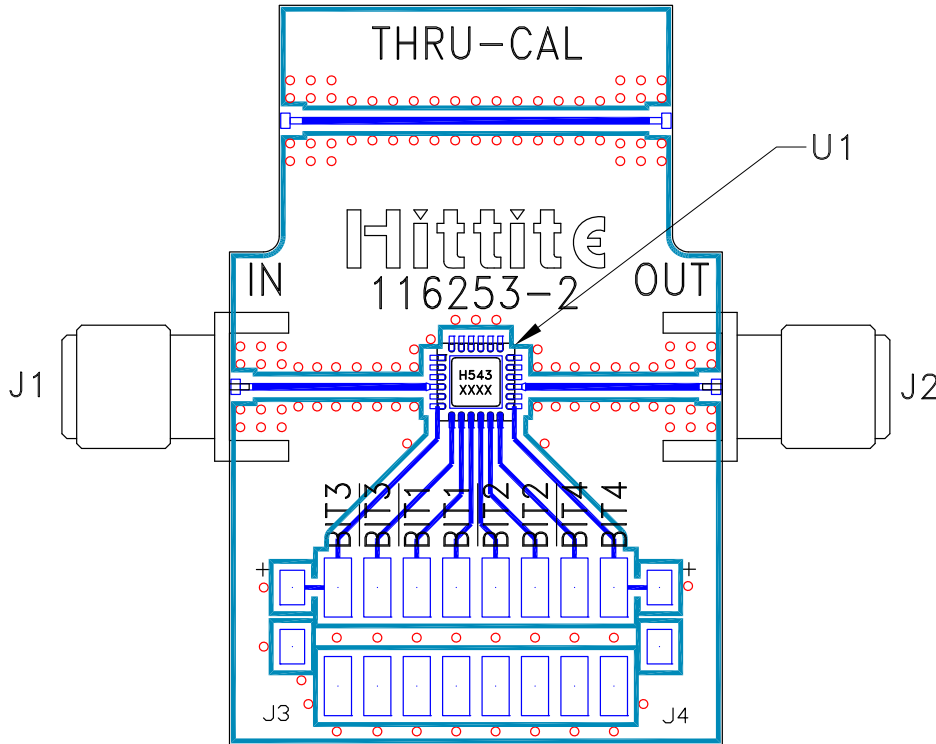

List of Materials for Evaluation PCB 116255 [1][3]

Item	Description
J1 - J2	PCB Mount SMA RF Connector
J3 - J4	Molex Header 2mm
U1	HMC543LC4B 4-Bit Digital Phase Shifter
PCB [2]	116253 Evaluation PCB

[1] Reference this number when ordering complete evaluation PCB

[2] Circuit Board Material: Rogers 4350

[3] Please refer to part's pin description and functional diagram for pin out assignments on evaluation board.

The circuit board used in the final application should use RF circuit design techniques. Signal lines should have 50 ohm impedance while the package ground leads and exposed paddle should be connected directly to the ground plane similar to that shown. A sufficient number of via holes should be used to connect the top and bottom ground planes. The evaluation board should be mounted to an appropriate heat sink. The evaluation circuit board shown is available from Hittite upon request.

