

Mounting Option

#4-40 Unified Threaded Inserts

Contact Detail

90 Degree Bend (Code 522 and 540 Contacts)

.156 [3.96] Contact Spacing x .200 [5.08] Row Spacing

THIS IS A C.A.D. GENERATED DRAWING
DO NOT MAKE MANUAL REVISIONS TO MASTER.



ISSUE NUMBER

ORIGINAL

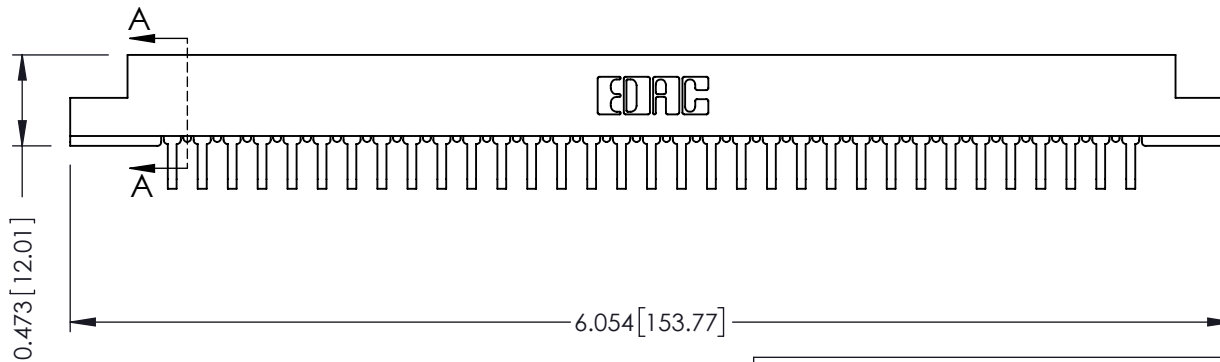
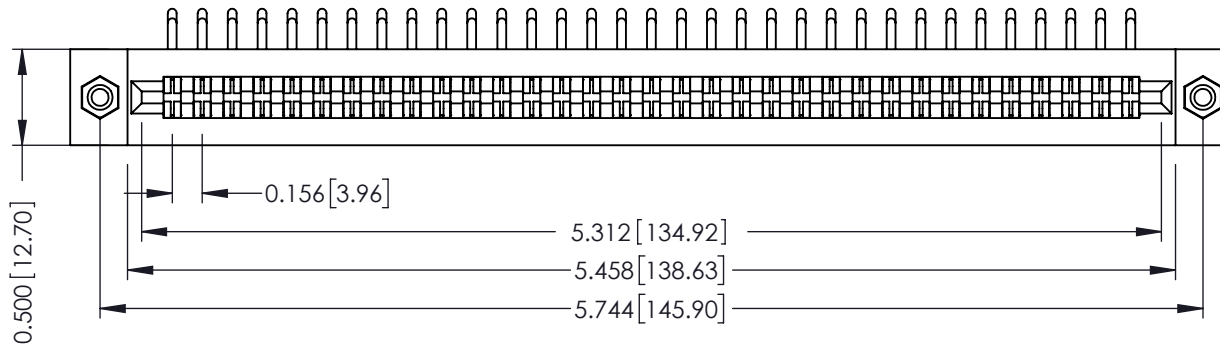

SECTION A-A

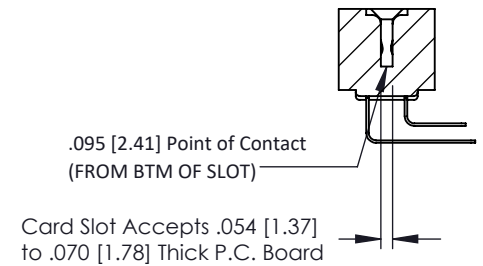

See Accompanying Pages for:

- Contact Bend Details
- Mounting Options

307 / 357 Card Edge Connector

Part Number: 357-066-559-208



EDAC INC
TORONTO, ONTARIO
CANADA

YOUR CONNECTION TO QUALITY & SERVICE

THESE DRAWINGS AND SPECIFICATIONS
ARE THE PROPERTY OF EDAC INC. AND
SHALL NOT BE REPRODUCED, OR COPIED
OR USED AS THE BASIS FOR THE
MANUFACTURE OR SALE OF APPARATUS
WITHOUT WRITTEN PERMISSION.

ACAD REFERENCE NO. 307 ENG MASTER

DRAWN: J.LEE DATE: AUG. 11/09

CHECKED: DATE:

SCALE: NTS SHEET 1 OF 3

DRAWING NUMBER	ISSUE
307 Assembly	1

Single Row Contacts - Read One Side of Daughter Board

THIS IS A C.A.D. GENERATED DRAWING
DO NOT MAKE MANUAL REVISIONS TO MASTER.



ISSUE NUMBER
ORIGINAL



558 Contact Code



559 Contact Code

Single Row Contacts - Read Both Sides of Daughter Board



553 Contact Code



554 Contact Code



557 Contact Code

Dual Row Contacts - Read Both Sides of Daughter Board



555 Contact Code



556 Contact Code

0.240 [6.10] Up to 27/54 Pin
0.162 [4.11] 28/56 and Over



558 Contact Code

0.240 [6.10] Up to 27/54 Pin
0.162 [4.11] 28/56 and Over
0.290 [7.37] Up to 27/54 Pin
.212 [5.38] 28/56 and Over



559 Contact Code



560 Contact Code

**307/ 357 Series Card Edge Connector
Contact Bend Detail**

ACAD REFERENCE NO. 307 ENG MASTER

DRAWN: J.LEE DATE: AUG. 11/09

CHECKED: DATE:

SCALE: NTS SHEET 2 OF 3

DRAWING NUMBER ISSUE

307 Assembly

1



EDAC INC
TORONTO, ONTARIO
CANADA

YOUR CONNECTION TO QUALITY & SERVICE

THESE DRAWINGS AND SPECIFICATIONS
ARE THE PROPERTY OF EDAC INC. AND
SHALL NOT BE REPRODUCED, OR COPIED
OR USED AS THE BASIS FOR THE
MANUFACTURE OR SALE OF APPARATUS
WITHOUT WRITTEN PERMISSION.

THIS IS A C.A.D. GENERATED DRAWING
DO NOT MAKE MANUAL REVISIONS TO MASTER.



ISSUE NUMBER

ORIGINAL



Code x01



Code x12

.128 [3.25] Dia Through Holes



.128 [3.25] Dia Through Holes

Code x02



Code x03



.156 [3.96] Dia Through Holes

Code x04



M3-0.5 Metric Threaded Insert

Code x07



#4-40 UNC Threaded Insert

Code x08



Code x58



Code x68



Code x78

307 / 357 Card Edge Connector Mounting Options



YOUR CONNECTION TO QUALITY & SERVICE

EDAC INC
TORONTO, ONTARIO
CANADA

THESE DRAWINGS AND SPECIFICATIONS ARE THE PROPERTY OF EDAC INC. AND SHALL NOT BE REPRODUCED, OR COPIED OR USED AS THE BASIS FOR THE MANUFACTURE OR SALE OF APPARATUS WITHOUT WRITTEN PERMISSION.

ACAD REFERENCE NO. 307 ENG MASTER

DRAWN: J.LEE DATE: AUG. 11/09

CHECKED: DATE:

SCALE: NTS SHEET 3 OF 3

DRAWING NUMBER ISSUE

307 Assembly

1