

MFG. ENG. APPROVED BY: DATE: QA APPROVED BY: DATE:

ASS'Y P/N	CONTACT QTY.	CABLE O.D. RANGE
W18980-5SG-P-518	5	0.18 - 0.20 [4.6 - 5.1]
W18980-5SG-P-521	5	0.21 - 0.22 [5.3 - 5.6]
W18980-5SG-P-522	5	0.22 - 0.23 [5.6 - 5.8]
W18980-6SG-P-518	6	0.18 - 0.20 [4.6 - 5.1]
W18980-6SG-P-521	6	0.21 - 0.22 [5.3 - 5.6]
W18980-6SG-P-522	6	0.22 - 0.23 [5.6 - 5.8]
W18980-7SG-P-518	7	0.18 - 0.20 [4.6 - 5.1]
W18980-7SG-P-521	7	0.21 - 0.22 [5.3 - 5.6]
W18980-7SG-P-522	7	0.22 - 0.23 [5.6 - 5.8]
W18980-XSG-P-5XX		

NOTES:

1. ALL PARTS ARE BULK PACKED.
2. REFER TO DRAWING HPMCSTD FOR CONTACT PATTERNS.
3. ALL DIMENSIONS ARE REFERENCE ONLY IN INCHES [mm], WITHIN ±0.015 UNLESS OTHERWISE NOTED.

CUSTOMER PRINT

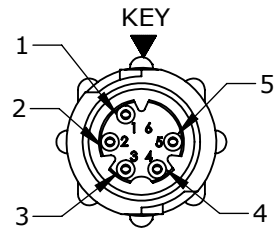

FACE VIEW
W18980-5SG-P-5XX
5 POSITION

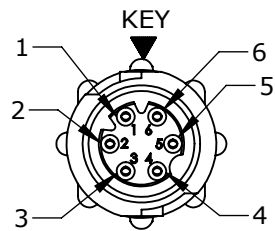

FACE VIEW
W18980-6SG-P-5XX
6 POSITION

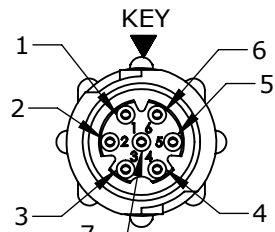

FACE VIEW
W18980-7SG-P-5XX
7 POSITION

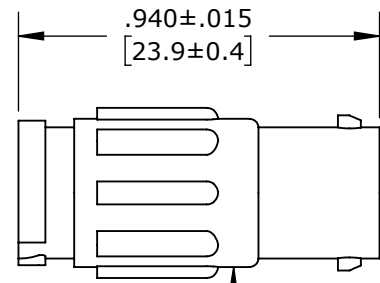

CABLE TO CABLE HOUSING
MAT'L: HOUSING -THERMOPLASTIC, BLACK

(5-7) # 26 SOCKET CONTACTS
CRIMP TAIL
MAT'L: GOLD PLATED, COPPER ALLOY

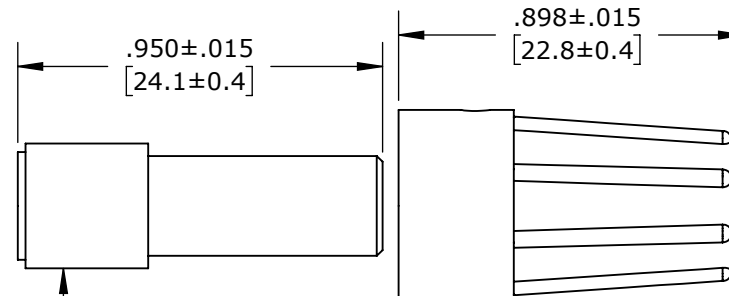

BACKSHELL
MAT'L: THERMOPLASTIC, BLACK

GROMMET
MAT'L: ELASTOMER, BLACK
SEE TABLE FOR CABLE O.D. SIZE OPTIONS

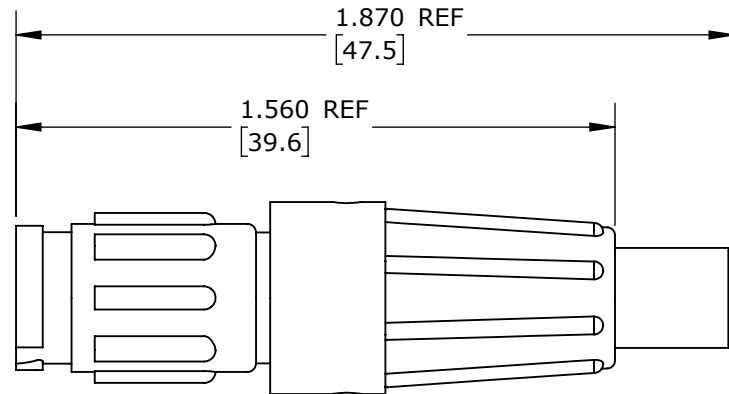

ASSEMBLED VIEW
FOR CUSTOMER REF. ONLY

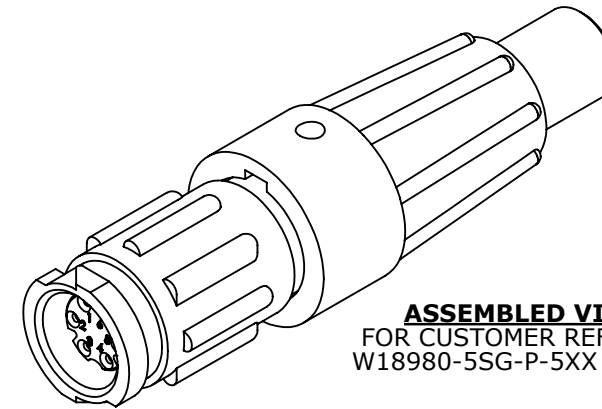

ASSEMBLED VIEW
FOR CUSTOMER REF. ONLY
W18980-5SG-P-5XX SHOWN

GROMMET SIZE = CABLE O.D. RANGE:
518 = 0.18 - 0.20 [4.6 - 5.1]
521 = 0.21 - 0.22 [5.3 - 5.6]
522 = 0.22 - 0.23 [5.6 - 5.8]

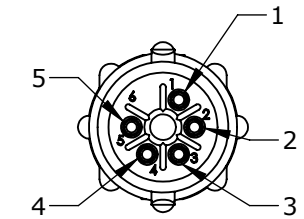

WIRING VIEW
W18980-5SG-P-5XX

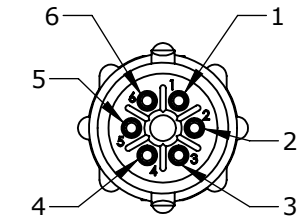

WIRING VIEW
W18980-6SG-P-5XX

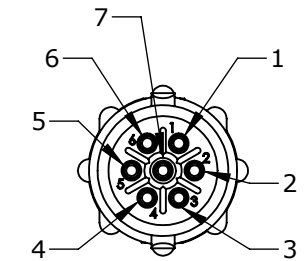

WIRING VIEW
W18980-7SG-P-5XX

PRELIMINARY

DIMENSIONS IS BRACKETS [] ARE METRIC

CUSTOMER APPROVAL

THIS DOCUMENT CONTAINS CONFIDENTIAL INFORMATION PROPRIETARY TO CONXALL CORPORATION. ANY REPRODUCTION, DISCLOSURE, OR USE OF THIS DOCUMENT /INFORMATION IS EXPRESSLY PROHIBITED UNLESS AUTHORIZED IN WRITING BY CONXALL CORPORATION.

APPROVED BY: _____
DATE: _____

RoHS COMPLIANT

0A	JGK	8/29/19	DRAWING CREATED FOR PDR #18004.	
REV.	INIT.	DATE	DESCRIPTION	
	JGK	8/29/19	ALL INFORMATION ILLUSTRATED IS THE PROPERTY OF "CONXALL CORPORATION". UNAUTHORIZED DUPLICATION OR DISTRIBUTION OF THIS DOCUMENT IS PROHIBITED.	
			601 E. WILDWOOD VILLA PARK, IL 60181	
			TITLE: CABLE TO CABLE CONN. ASS'Y (5-7) #26 SOCKET CONTACTS, CRIMP INSTA-CLICK, MICRO-CON-X STANDARD PRODUCT	
			CUSTOMER: _____	
			SCALE: NTS	SHEET: 1 OF 1
			FILE: W18980-XSG-P-5XX	DIRECTORY: SLW
			PART NUMBER: W18980-XSG-P-5XX	REV: 0A