

## Item description

### Female connector/socket *WINSTA*® MIDI rated current 25 A

The *WINSTA*® MIDI female connector/socket rated current 25 A provides the foundation for installation of fine-stranded and solid conductors. The pluggable installation connectors with spring pressure connection technology work completely without screw connections. They allow resource-efficient, error-free installation in a large number of possible uses. The mechanical coding and color coding of the pluggable installation connector ensure error-free installation of the individual components – including protection against mismatching. The pluggable installation connector offers protection against contact with live components in accordance with protection type IP20 (When mated and secured with a strain relief housing: IP2xC (These compact connectors are not designed for use in open, easily accessible areas!)). Pluggable installation connectors with B coding from the *WINSTA*® MIDI line are available in gray, light green, or pink, allowing you to distinguish different circuits, for example for light, pumps or, sun blinds. Your own pole marking is possible in addition. This pluggable installation connector can be used for a voltage load of up to 25 A. As a result, it can also be used for high power loads. Our *WINSTA*® MIDI product line achieves maximum flexibility for the electrical installation. Through its Push-in *CAGE CLAMP*® spring pressure connection technology, it achieves error-free, time-saving installation and offers flexibility for meeting an enormous variety of installation requirements.

### Push-in *CAGE CLAMP*® spring pressure connection technology – pluggable installation instead of laborious screw connections!

The *WINSTA*® Pluggable Connection System allows pluggable electrical installation. This saves time, lowers costs, and reduces the need for servicing. Choose durability and quality – the *WINSTA*® MIDI pluggable installation connector with protection against mismatching from WAGO makes

Subject to changes. Please also observe the further product documentation!



the electrical installation of electrical components significantly easier.

- effective protection against mismatching
- for automation controllers
- with B coding for use in process automation, such as lighting technology, among other examples
- custom-engineered solutions
- quick replacement of defective units during ongoing operation

## Data Notes

Variants: Other pole markings  
Other versions (or variants) can be requested from WAGO Sales or configured at <https://configurator.wago.com/>.

## Electrical data

### Ratings per IEC/EN

Ratings per	IEC/EN 60664-1
Nominal voltage (III/3)	250 V
Rated impulse voltage (III/3)	4 kV
Rated current	25 A
Legend (ratings)	(III / 3) ≙ Overvoltage category III / Pollution degree 3

### Ratings per UL 1977

Note for the US market	Some versions may also be used for current interruption in accordance with the UL certificate in select applications with currents below 16 A and voltages up to 600 V. For further information, please contact your local sales office.
Rated voltage (UL 1977)	600 V
Rated current UL 1977	23 A

## General

Note on contact resistance	approx. 1 mΩ of contact resistance approx. 0.25 mΩ contact transition plug/socket
----------------------------	--

Subject to changes. Please also observe the further product documentation!



## Connection data

Connection points	6
Total number of potentials	3

## Connection 1

Connection technology	Push-in CAGE CLAMP®
Actuation type	Operating tool Push-in
Nominal cross-section	4 mm <sup>2</sup> / 12 AWG
Solid conductor	0.5 ... 4 mm <sup>2</sup> / 20 ... 12 AWG
Solid conductor; push-in termination	1.5 ... 4 mm <sup>2</sup> / 16 ... 12 AWG
Stranded conductor	0.5 ... 2.5 mm <sup>2</sup> / 20 ... 14 AWG
Fine-stranded conductor	0.5 ... 4 mm <sup>2</sup> / 20 ... 12 AWG
Fine-stranded conductor; with insulated ferrule	0.25 ... 1.5 mm <sup>2</sup> / 20 ... 16 AWG
Fine-stranded conductor; with uninsulated ferrule	0.25 ... 2.5 mm <sup>2</sup> / 20 ... 14 AWG
Fine-stranded conductor; with ferrule; push-in termination	1.5 mm <sup>2</sup> / 16 AWG
Strip length	9 mm / 0.35 inches
Pole number	3
Conductor entry direction to mating direction	0°

## Physical data

Pin spacing	10 mm / 0.394 inches
Width	30 mm / 1.181 inches
Height	12.9 mm / 0.508 inches
Depth	37.5 mm / 1.476 inches

## Mechanical Data

Application	Control technology
Coding	B
Variable coding	Yes
Marking	1 2 3
Potential marking	1 2 3
Mating force of a plug-in connection	approx. 20 ... 70 N (depending on pole number)
Retention force of a plug-in connection	Locked: > 80 N
Unmating force of a plug-in connection	Unlocked: approx. 20 ... 70 N (depending on pole number)

Subject to changes. Please also observe the further product documentation!



Number of mating cycles	200, without resistive load
Protection type	IP20; When mated and secured with a strain relief housing: IP2xC (These compact connectors are not designed for use in open, easily accessible areas!)

### Plug-in connection

Contact type (pluggable connector)	Female connector/socket
Connector (connection type)	for conductor
Mismating protection	Yes
Note on mismating protection	All <i>WINSTA</i> <sup>®</sup> components are 100% protected against mismating when: a.) plugging different numbers of poles b.) plugging while rotated 180 c.) plugging while laterally staggered d.) plugging one pole
Locking lever	Can be retrofitted
Locking of plug-in connection	locking lever
Note on locking system	All connectors for mounted installations (snap-in versions for lighting fixtures or devices, all types of PCB and distribution connectors) are factory-equipped with locking levers to ensure plugs and sockets are securely locked. Additional locking levers are only required for flying leads (plug/socket).

### Material Data

Note (material data)	Information on material specifications can be found here
Color	pink
Cover color	gray
Material group	I
Insulation material	Polyamide (PA66)
Flammability class per UL94	V0
Clamping spring material	Chrome-nickel spring steel (CrNi)
Contact material	Copper or copper alloy; surface-treated
Contact plating	Tin
Fire load	0.178 MJ
Weight	8.5 g

Subject to changes. Please also observe the further product documentation!

WAGO GmbH & Co. KG  
Hansastr. 27  
32423 Minden  
Phone: +49571 887-0 | Fax: +49571 887-169  
Email: [info.de@wago.com](mailto:info.de@wago.com) | Web: [www.wago.com](http://www.wago.com)

Do you have any questions about our products?  
We are always happy to take your call at +49 (571) 887-44222.

## Environmental requirements

Processing temperature	-5 ... +40 °C
Continuous operating temperature	-35 ... +85 °C
Note on continuous operating temperature	Insulating parts for temperatures ≤ 105 °C

## Commercial data



Product Group	20 (Winsta)
eCl@ss 10.0	27-44-06-05
eCl@ss 9.0	27-44-06-05
ETIM 8.0	EC002560
ETIM 7.0	EC002560
PU (SPU)	100 pcs
Packaging type	box
Country of origin	DE
GTIN	4050821451129
Customs tariff number	85366990990

## Environmental Product Compliance

RoHS Compliance Status	Compliant, No Exemption
------------------------	-------------------------

## Approvals / Certificates

### General approvals

Logo	Approval	Additional Approval Text	Certificate name
	CCA DEKRA Certification B.V.	IEC 61984	NL-32104
	CCA DEKRA Certification B.V.	EN 61984	2173495.01
	cURus Underwriters Laboratories Inc.	UL 1977	E45171

## Declarations of conformity and manufacturer's declarations

Logo	Approval	Additional Approval Text	Certificate name
------	----------	--------------------------	------------------

Subject to changes. Please also observe the further product documentation!

WAGO GmbH & Co. KG  
 Hansastr. 27  
 32423 Minden  
 Phone: +49571 887-0 | Fax: +49571 887-169  
 Email: [info.de@wago.com](mailto:info.de@wago.com) | Web: [www.wago.com](http://www.wago.com)

Do you have any questions about our products?  
 We are always happy to take your call at +49 (571) 887-44222.



EU-Declaration of Conformity  
WAGO GmbH & Co. KG

-

-





UK-Declaration of Conformity  
WAGO GmbH & Co. KG

-

-

### Approvals for marine applications

Logo	Approval	Additional Approval Text	Certificate name
	<b>ABS</b> American Bureau of Shipping	-	19- HG1868589- PDA
	<b>DNV GL</b> Det Norske Veritas, Germanischer Lloyd	-	TAE00001Z6
	<b>LR</b> Lloyds Register	IEC 61984	LR22429487TA

### Counterpart



**Item no.770-1613**

T-distribution connector; 3-pole; Cod. B; 1 input; 2 outputs; 2 locking levers; pink

[www.wago.com/770-1613](http://www.wago.com/770-1613)



**Item no.770-1663**

h-distribution connector; 3-pole; Cod. B; 1 input; 2 outputs; outputs on one side; 2 locking levers; pink

[www.wago.com/770-1663](http://www.wago.com/770-1663)



**Item no.770-1716**

3-way distribution connector; 3-pole; Cod. B; 1 input; 3 outputs; pink

[www.wago.com/770-1716](http://www.wago.com/770-1716)



**Item no.770-1713**

T-distribution connector; 3-pole; Cod. B; 1 input; 2 outputs; 3 locking levers; for flying leads; pink

[www.wago.com/770-1713](http://www.wago.com/770-1713)

Subject to changes. Please also observe the further product documentation!

WAGO GmbH & Co. KG

Hansastr. 27







32423 Minden

Phone: +49571 887-0 | Fax: +49571 887-169

Email: [info.de@wago.com](mailto:info.de@wago.com) | Web: [www.wago.com](http://www.wago.com)

Do you have any questions about our products?





We are always happy to take your call at +49 (571) 887-44222.

	<b>Item no.770-1763</b> h-distribution connector; 3-pole; Cod. B; 1 input; 2 outputs; outputs on one side; 3 locking levers; for flying leads; pink	<a href="http://www.wago.com/770-1763">www.wago.com/770-1763</a>
	<b>Item no.770-293</b> Plug; 3-pole; Cod. B; 4,00 mm <sup>2</sup> ; pink	<a href="http://www.wago.com/770-293">www.wago.com/770-293</a>
	<b>Item no.770-793</b> Snap-in plug; 3-pole; Cod. B; 4,00 mm <sup>2</sup> ; pink	<a href="http://www.wago.com/770-793">www.wago.com/770-793</a>
	<b>Item no.770-893/011-000</b> Plug for PCBs; angled; 3-pole; Cod. B; pink	<a href="http://www.wago.com/770-893/011-000">www.wago.com/770-893/011-000</a>
	<b>Item no.770-893</b> Plug for PCBs; straight; 3-pole; Cod. B; pink	<a href="http://www.wago.com/770-893">www.wago.com/770-893</a>
	<b>Item no.771-9993/005-107</b> pre-assembled interconnecting cable; Eca; Socket/plug; 3-pole; Cod. B; 1 m; 1,00 mm <sup>2</sup> ; pink	<a href="http://www.wago.com/771-9993/005-107">www.wago.com/771-9993/005-107</a>
	<b>Item no.771-9993/205-107</b> pre-assembled connecting cable; Eca; Plug/open-ended; 3-pole; Cod. B; 1 m; 1,00 mm <sup>2</sup> ; pink	<a href="http://www.wago.com/771-9993/205-107">www.wago.com/771-9993/205-107</a>

## Required accessories

### Locking levers

Locking system

	<b>Item no.: 770-121</b> Locking lever; for flying leads; for manual operation; white	<a href="http://www.wago.com/770-121">www.wago.com/770-121</a>
	<b>Item no.: 770-131</b> Locking lever; for flying leads; for tool operation; white	<a href="http://www.wago.com/770-131">www.wago.com/770-131</a>
	<b>Item no.: 770-101</b> Locking lever; for flying leads; for manual operation; black	<a href="http://www.wago.com/770-101">www.wago.com/770-101</a>
	<b>Item no.: 770-111</b> Locking lever; for flying leads; for tool operation; black	<a href="http://www.wago.com/770-111">www.wago.com/770-111</a>

## Optional accessories

### Marking accessories

Marker

	<b>Item no.: 770-450/000-002</b> Marker card; Plastic; yellow	<a href="http://www.wago.com/770-450/000-002">www.wago.com/770-450/000-002</a>
--	--	--

Subject to changes. Please also observe the further product documentation!



Item no.: 770-450/000-001  
Marker card; Plastic; green

[www.wago.com/770-450/000-001](http://www.wago.com/770-450/000-001)



Item no.: 770-450/000-005  
Marker card; Plastic; red

[www.wago.com/770-450/000-005](http://www.wago.com/770-450/000-005)



Item no.: 770-450  
Marker card; Plastic; white

[www.wago.com/770-450](http://www.wago.com/770-450)



Item no.: 770-450/000-006  
Marker card; Plastic; blue

[www.wago.com/770-450/000-006](http://www.wago.com/770-450/000-006)



Item no.: 770-450/000-012  
Marker card; Plastic; orange

[www.wago.com/770-450/000-012](http://www.wago.com/770-450/000-012)

## Mounting

Snap-in frame



Item no.: 770-318  
Snap-in frame; 3-pole; 1.0 ... 3.0 mm; black

[www.wago.com/770-318](http://www.wago.com/770-318)



Item no.: 770-338  
Snap-in frame; 3-pole; 1.0 ... 3.0 mm; white

[www.wago.com/770-338](http://www.wago.com/770-338)

## Cover

Cover



Item no.: 770-201  
Lockout cap; 12-pole, separable; for sockets; Plastic; black

[www.wago.com/770-201](http://www.wago.com/770-201)



Item no.: 770-221  
Lockout cap; 12-pole, separable; for sockets; Plastic; white

[www.wago.com/770-221](http://www.wago.com/770-221)

## Tool

Operating tool



Item no.: 210-719  
Operating tool; Blade: 2.5 x 0.4 mm; with a partially insulated shaft

[www.wago.com/210-719](http://www.wago.com/210-719)

Subject to changes. Please also observe the further product documentation!





**Item no.: 770-383**  
Operating tool; 3-way; green

[www.wago.com/770-383](http://www.wago.com/770-383)

## Strain relief

### Strain relief housing



**Item no.: 770-503**  
Strain relief housing; 3-pole; for 2 cables; 8.0 ... 11.5 mm; 55 mm; black

[www.wago.com/770-503](http://www.wago.com/770-503)



**Item no.: 770-503/023-000**  
Strain relief housing; 3-pole; for 2 cables; 4.5 ... 8.0 mm; 55 mm; black

[www.wago.com/770-503/023-000](http://www.wago.com/770-503/023-000)



**Item no.: 770-503/021-000**  
Strain relief housing; 3-pole; for 1 cable; 9.0 ... 13.0 mm; 71 mm; black

[www.wago.com/770-503/021-000](http://www.wago.com/770-503/021-000)



**Item no.: 770-503/035-000**  
Strain relief housing; 3-pole; with locking clip; for 1 cable; 7.0 ... 11.5 mm; 48 mm; black

[www.wago.com/770-503/035-000](http://www.wago.com/770-503/035-000)



**Item no.: 770-503/038-000**  
Strain relief housing; 3-pole; with locking clip; for 1 cable; 7.0 ... 11.5 mm; 48 mm; black

[www.wago.com/770-503/038-000](http://www.wago.com/770-503/038-000)



**Item no.: 770-503/032-000**  
Strain relief housing; 3-pole; with locking clip; for 2 cables; 8.0 ... 11.5 mm; 55 mm; black

[www.wago.com/770-503/032-000](http://www.wago.com/770-503/032-000)



**Item no.: 770-513/038-000**  
Strain relief housing; 3-pole; with locking clip; for 1 cable; 7.0 ... 11.5 mm; 48 mm; white

[www.wago.com/770-513/038-000](http://www.wago.com/770-513/038-000)



**Item no.: 770-513**  
Strain relief housing; 3-pole; for 2 cables; 8.0 ... 11.5 mm; 55 mm; white

[www.wago.com/770-513](http://www.wago.com/770-513)



**Item no.: 770-513/021-000**  
Strain relief housing; 3-pole; for 1 cable; 9.0 ... 13.0 mm; 71 mm; white

[www.wago.com/770-513/021-000](http://www.wago.com/770-513/021-000)



**Item no.: 770-513/032-000**  
Strain relief housing; 3-pole; for 2 cables; 8.0 ... 11.5 mm; 55 mm; white

[www.wago.com/770-513/032-000](http://www.wago.com/770-513/032-000)

Subject to changes. Please also observe the further product documentation!



Item no.: 770-513/035-000

Strain relief housing; 3-pole; with locking clip; for 1 cable; 7.0 ... 11.5 mm; 48 mm; white

[www.wago.com/770-513/035-000](http://www.wago.com/770-513/035-000)



Item no.: 770-513/023-000

Strain relief housing; 3-pole; for 2 cables; 4.5 ... 8.0 mm; 55 mm; white

[www.wago.com/770-513/023-000](http://www.wago.com/770-513/023-000)

## Downloads

### Documentation

#### Bid Text

770-283 X81 - Datei	2019 Feb 19	xml 3.0 kB	Download
770-283 doc - Datei	2015 Jun 8	doc 24.6 kB	Download

### CAD/CAE-Data

#### CAD data

2D/3D Models 770-283	URL	Download
----------------------	-----	----------

#### CAE data

WSCAD Universe 770-283	URL	Download
ZUKEN Portal 770-283	URL	Download

### Environmental Product Compliance

#### Compliance Search

Environmental Product Compliance 770-283 Socket; 3-pole; Cod. B; 4,00 mm <sup>2</sup> ; pink	URL	Download
---	-----	----------

### Installation Notes

#### Conductor termination

Subject to changes. Please also observe the further product documentation!

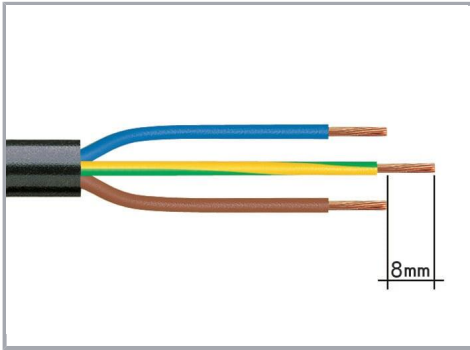

1. Strip length, outer insulation = 35 mm (2-pole), 55 mm (3- to 5-pole)
2. Strip length = 9 mm
3. Extended ground conductor = 8 mm

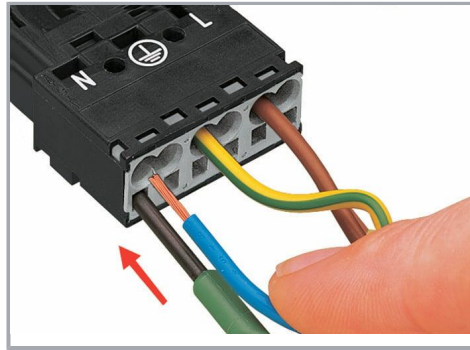

To terminate fine-stranded conductors, open the clamping unit via screwdriver (2.5 mm blade width) and insert a stripped conductor until it hits the backstop.

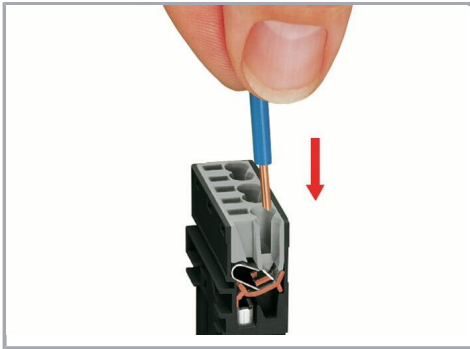

Insert the stripped solid conductor until it hits the backstop.

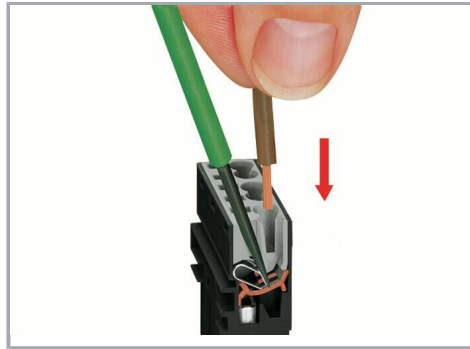

To terminate fine-stranded conductors, open the clamping unit via screwdriver (2.5 mm blade width) and insert a stripped conductor until it hits the backstop.

### Conductor removal

Subject to changes. Please also observe the further product documentation!

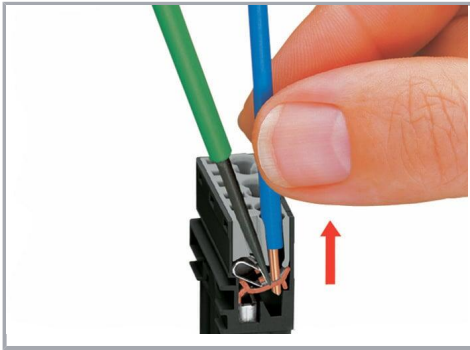

To remove the conductor, actuate the clamp via screwdriver (2.5 mm blade width) and pull out the conductor.

### Installation

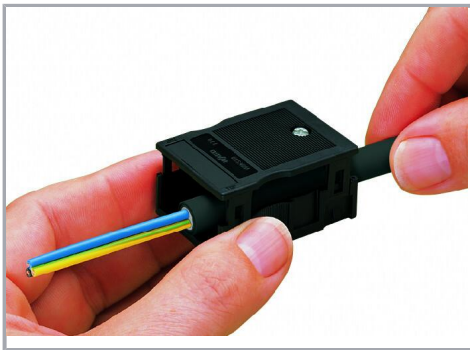

We recommend pulling the pre-latched strain relief housing over the cable prior to termination. However, the strain relief can be mounted at a later time as well.

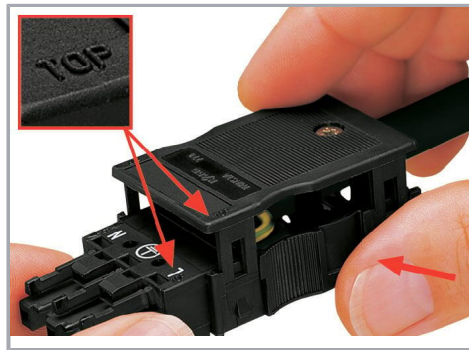

Latch the strain relief housing onto the plug /socket. Note the "TOP" inscription.

Subject to changes. Please also observe the further product documentation!

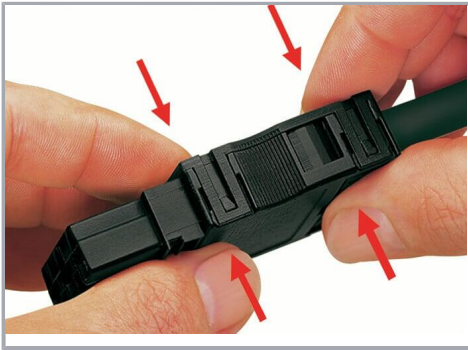

Prepare strain relief housing by snapping together upper and bottom part.



Tighten strain relief screw with screwdriver (2.5 mm blade width).

### Coding

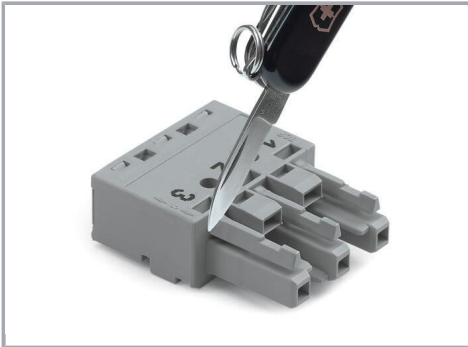

Simply cut off the coding pin from the socket.

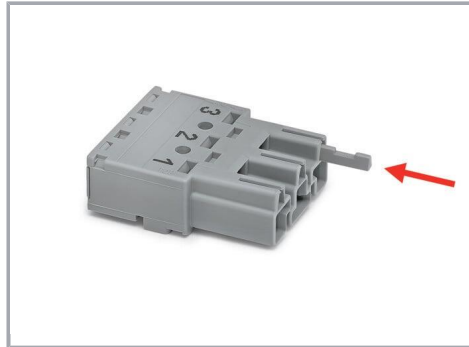

Insert coding pin into plug (break first) until it engages.

### Mismatching protection

Subject to changes. Please also observe the further product documentation!

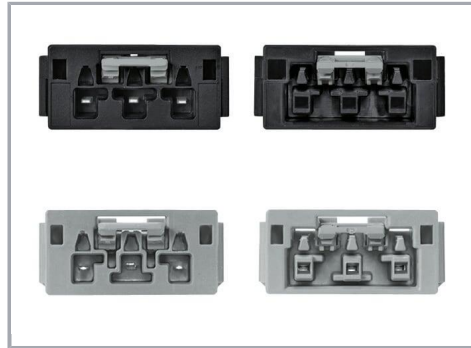
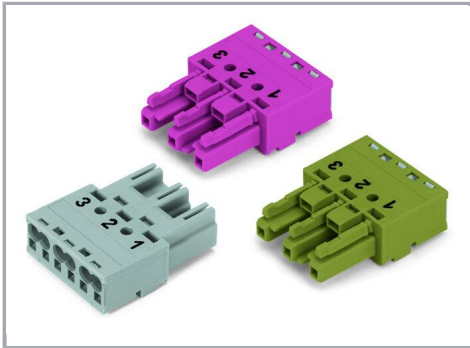

B-coded connectors with different colors can be plugged together.

Important note:

Different colors and/or pole markings are used for circuit identification.

Only connectors of the same color and same pole marking must be plugged together.

B-coded connectors (shown in gray) not only differ in color, but also in their design, making them incompatible with other coded connectors.



Easy circuit identification via different marking and colors

## Product family

**WINSTA® MIDI**

[Show all products from the family](#)

Subject to changes. Please also observe the further product documentation!