





A Product Line of  
Diodes Incorporated



# SPECIFICATION FOR APPROVAL

CUSTOMER	
NOMINAL FREQUENCY	<b>25.000000 MHz</b>
PRODUCT TYPE	<b>TYPE GB 49S QUARTZ CRYSTAL</b>
PART NUMBER	<b>GB2500095</b>
CUSTOMER P/N	
ISSUE DATE	<b>March 4, 2018</b>
VERSION	<b>D</b>

APPROVED	PREPARED	QA
		

## Diodes Incorporated

No.2, Ziqiang 5th Rd., Zhongli Industrial Park,  
Zhongli Dist., Taoyuan City 32063, Taiwan (R.O.C.)  
TEL:886-3-451-8888  
FAX:886-3-461-3865  
<https://www.diodes.com>

- \*RoHS Compliant
- \*HF-Halogen Free
- \*REACH Compliant

# TYPE GB 49S QUARTZ CRYSTAL

## GB2500095

VER.D 04-MAR-18

### ELECTRICAL SPECIFICATIONS

Item	Symbol	Specifications	Units	Notes
Nominal Frequency	Fn	25.000000	MHz	
Mode of Oscillation	MO	AT Cut-Fundamental		
Calibration Load Capacitance	CL	18	pF	
Calibration Tolerance	FL	± 20	ppm	at 25°C±3°C
Operating Temperature Range	TR	-40 to +85	°C	
Frequency Stability(Frequency Deviation over the Operating Temperature Range)	F/T	± 20	ppm	Reference to the Frequency at 25°C
Operating Drive Level		100	μW	
Maximum Drive Level		500	μW	
Equivalent Series Resistance	ESR	30	Ω	Max.
Shunt Capacitance	C0	5	pF	Max.
Aging at 25°C		± 3	ppm	Max, 1st year
Storage Temperature		-55 to +125	°C	
Insulation Resistance		500	MΩ	Min

### RELIABILITY SPECIFICATIONS

**MECHANICAL AND ENVIRONMENTAL RATINGS:**

- a) FINE LEAK TEST: JESD22-A109 (Condition 1A)
- b) GROSS LEAK TEST: JESD22-A109 (Condition C)
- c) MOISTURE RESISTANCE: JESD22-A113
- d) SHOCK: JESD22-B104 (Condition B)
- e) SOLDERABILITY : (RoHS version): J-STD-002
- f) VIBRATION: JESD22-B103
- g) SOLVENT RESISTANCE: JESD22-B107
- h) RESISTANCE TO SOLDERING HEAT (RoHS version): J-STD-020D Table 5.2 Pb free devices (3 cycles max)

### SUGGESTED IR REFLOW PROFILE

\*As per IPC-JEDEC J-STD-020D

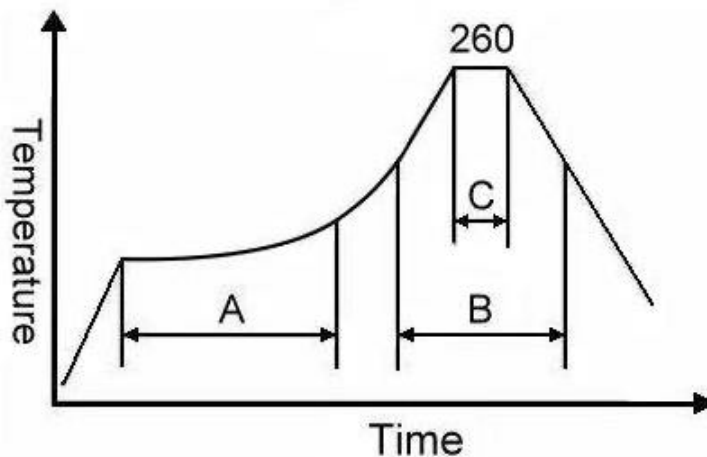

Note:

	Stage	Temperature	Time
A	Preheat	150~200°C	60~120 Sec
B	Primary Heat	217°C	60~150 Sec
C	Peak	260°C	10 Sec

# TYPE GB 49S QUARTZ CRYSTAL

**GB2500095**

VER.D 04-MAR-18

## MARKING

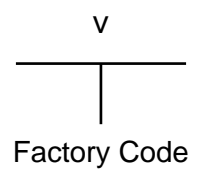
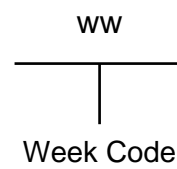
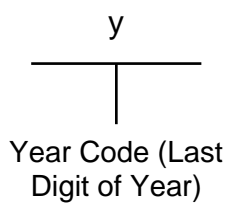
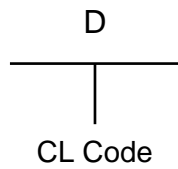
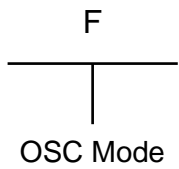
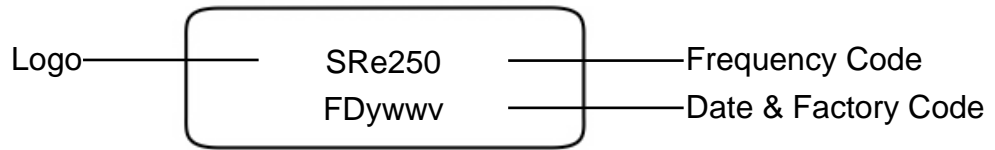

## MECHANICAL DRAWINGS ( Scale: None. Dimensions are in mm.)

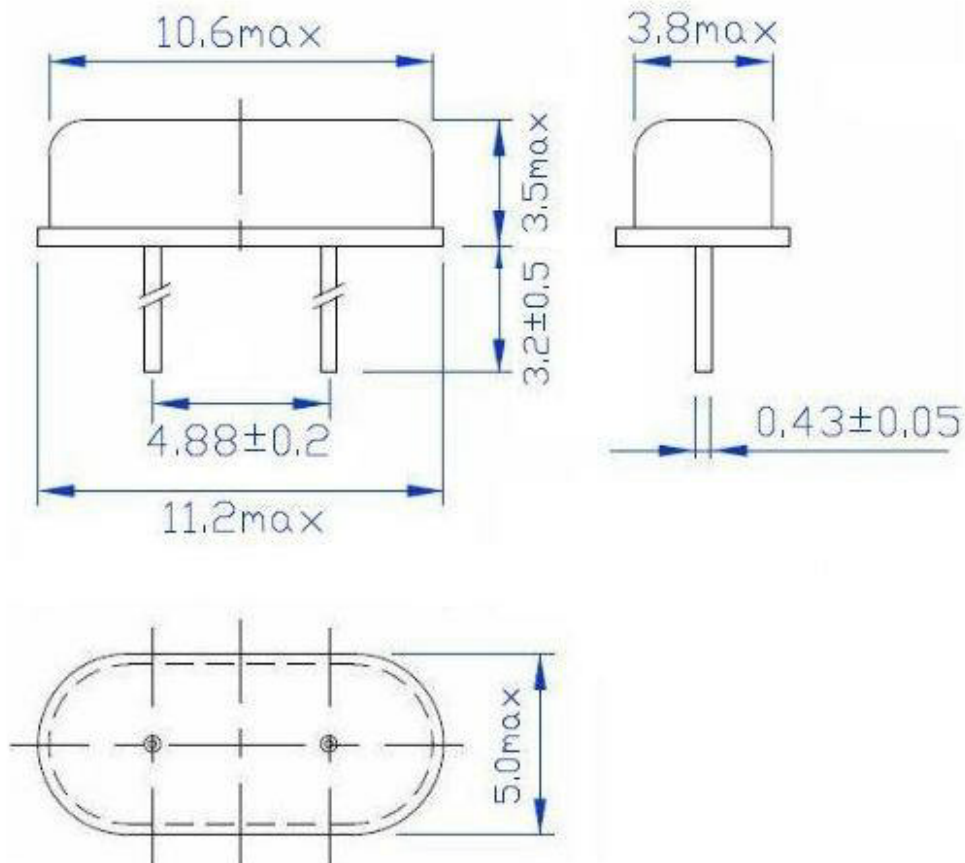

# TYPE GB 49S QUARTZ CRYSTAL

## GB2500095

VER.D 04-MAR-18

### PACKING

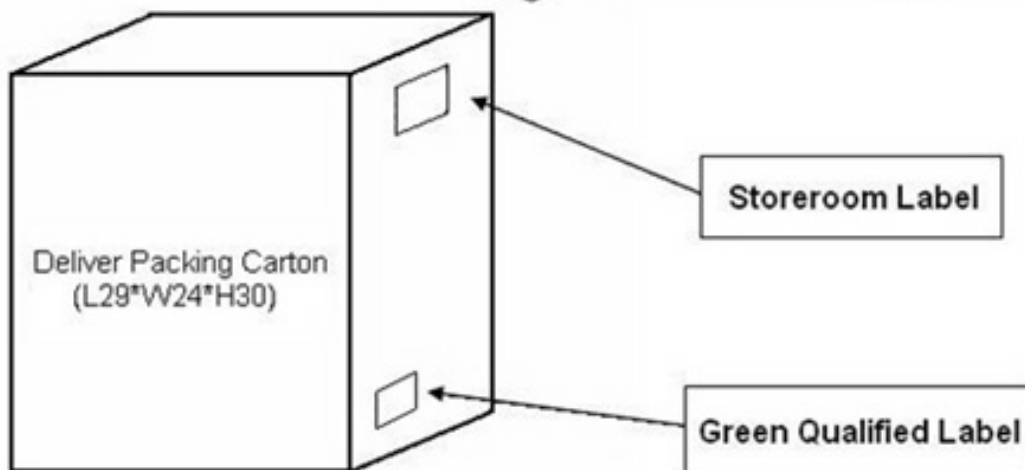
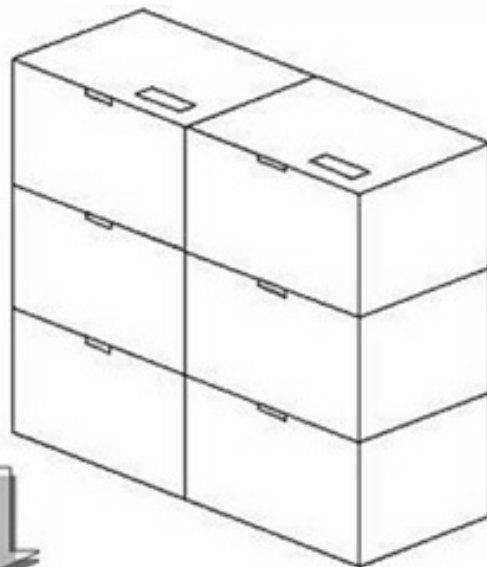
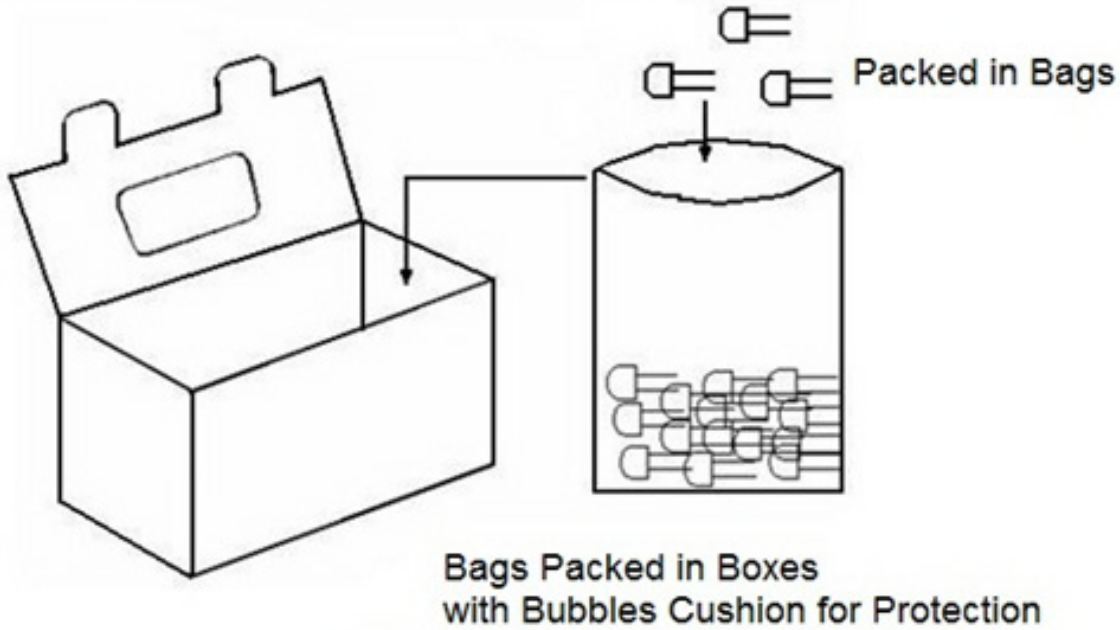

# TYPE GB 49S QUARTZ CRYSTAL

**GB2500095**

VER.D 04-MAR-18

## VERSION HISTORY

Version No.	Version Date	Description	Notes
A	Oct. 6, 2010	Initial Release	
B	Jan. 18, 2013	Updated Suggested IR Reflow Profile & Format	
C	Aug. 26, 2016	Updated packing	
D	Mar. 4, 2018	Updated logo	