

1502070001  
1502070008

CKT NO	WIRE COLOR
1	BLACK
2	WHITE

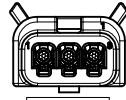

1502070002  
1502070009

CKT NO	WIRE COLOR
1	BLACK
2 & 3	WHITE

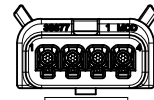

1502070003  
1502070010

CKT NO	WIRE COLOR
1	BLACK
2, 3 & 4	WHITE

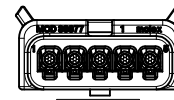

1502070004  
1502070011

CKT NO	WIRE COLOR
1	BLACK
2, 3, 4 & 5	WHITE

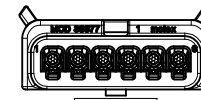

1502070005  
1502070012

CKT NO	WIRE COLOR
1	BLACK
2, 3, 4, 5 & 6	WHITE

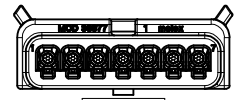

1502070006  
1502070013

CKT NO	WIRE COLOR
1	BLACK
2, 3, 4, 5, 6 & 7	WHITE

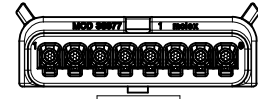

1502070007  
1502070014

CKT NO	WIRE COLOR
1	BLACK
2, 3, 4, 5, 6, 7 & 8	WHITE

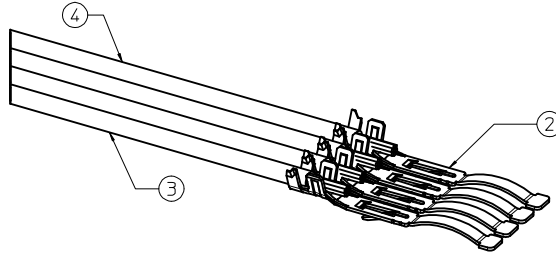

THIS VIEW IS ONLY FOR REPRESENTATION

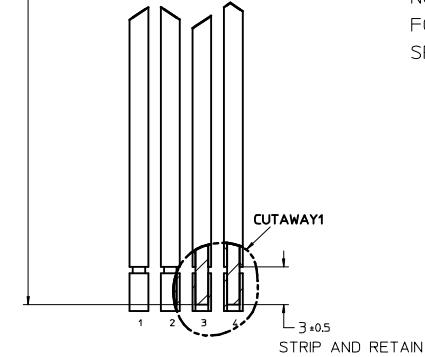
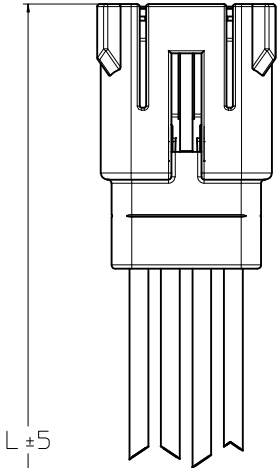
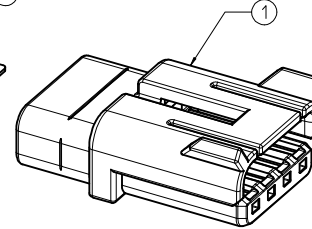

NOTE:  
FOR CRIMP SPECIFICATION AND STRIP LENGTH DETAILS, REFER APPLICATION TOOLING SPECIFICATION SHEET. DOCUMENT NO. ATS-639030200

BOM SHOWN FOR 4 CKT

ITEM NO	DESCRIPTION	PART NO	COLOR	QTY
4	UL1061, 20 AWG TINNED COPPER WIRE, BLACK	150206-0002	BLACK	1
3	UL1061, 20 AWG TINNED COPPER WIRE, WHITE	150206-0001	WHITE	3
2	DITTO GENDERLESS CRP TER HSM Cu 20-22AWG	36876-0001	NA	4
1	DITTO GENDERLESS WTW HSG FRIC LOCK 1X4	36877-0004	NA	1

QUALITY SYMBOLS	GENERAL TOLERANCES (UNLESS SPECIFIED)		DIMENSION STYLE		SCALE	DESIGN UNITS	THIRD ANGLE PROJECTION
	mm	INCH	MM ONLY	DATE			
▽=0	4 PLACES ±---	±---	NCSR	2015/02/20	4:1	METRIC	DITTO SINGLE-ENDED HARNESS ASSY.2 TO 8 CKT WITH 150206 SERIES WIRE <b>molex</b> DOCUMENT NO. SD-150207-0001 SHEET NO. 1 OF 2
▽=0	3 PLACES ±---	±---	CHECKED BY	DATE			
▽=0	2 PLACES ±---	±---	NCSR	2015/02/20			
▽=0	1 PLACE ±---	±---	APPROVED BY	DATE			
▽=0	0 PLACE ±---	±---	KPRASAD	2015/02/23			
	ANGULAR ±---		MATERIAL NO.		SEE SHEET 2		
DRAFT WHERE APPLICABLE MUST REMAIN WITHIN DIMENSIONS			SIZE 1		THIS DRAWING CONTAINS INFORMATION THAT IS PROPRIETARY TO MOLEX INCORPORATED AND SHOULD NOT BE USED WITHOUT WRITTEN PERMISSION		

MOLEX P/N	FCT P/N	MATERIAL DESCRIPTION	HOUSING	TERMINAL	WIRE 1 BLACK (B)	WIRE 2 WHITE (W)	LENGTH L (mm)	CKT NO.								WIRE CUT LENGTH			
								1	2	3	4	5	6	7	8				
1502070001	KAB2289L0.3V01	FCT DITTO SG/END HARNESS ORG 2 CKT 300mm	36877-0002	36876 -0001	150206 -0002	150206 -0001	300	B	W	-	-	-	-	-	-	-	284±2		
1502070002	KAB2290L0.3V01	FCT DITTO SG/END HARNESS ORG 3 CKT 300mm	36877-0003				300	B	W	W	-	-	-	-	-	-		-	-
1502070003	KAB2291L0.3V01	FCT DITTO SG/END HARNESS ORG 4 CKT 300mm	36877-0004				300	B	W	W	W	-	-	-	-	-		-	-
1502070004	KAB2292L0.3V01	FCT DITTO SG/END HARNESS ORG 5 CKT 300mm	36877-0005				300	B	W	W	W	W	-	-	-	-		-	-
1502070005	KAB2293L0.3V01	FCT DITTO SG/END HARNESS ORG 6 CKT 300mm	36877-0006				300	B	W	W	W	W	W	-	-	-		-	-
1502070006	KAB2294L0.3V01	FCT DITTO SG/END HARNESS ORG 7 CKT 300mm	36877-0007				300	B	W	W	W	W	W	W	-	-		-	-
1502070007	KAB2295L0.3V01	FCT DITTO SG/END HARNESS ORG 8 CKT 300mm	36877-0008				300	B	W	W	W	W	W	W	W	-	-	-	134±2
1502070008	KAB2289L0.15V01	FCT DITTO SG/END HARNESS ORG 2 CKT 150mm	36877-0002				150	B	W	-	-	-	-	-	-	-	-	-	
1502070009	KAB2290L0.15V01	FCT DITTO SG/END HARNESS ORG 3 CKT 150mm	36877-0003				150	B	W	W	-	-	-	-	-	-	-	-	
1502070010	KAB2291L0.15V01	FCT DITTO SG/END HARNESS ORG 4 CKT 150mm	36877-0004				150	B	W	W	W	-	-	-	-	-	-	-	
1502070011	KAB2292L0.15V01	FCT DITTO SG/END HARNESS ORG 5 CKT 150mm	36877-0005				150	B	W	W	W	W	-	-	-	-	-	-	
1502070012	KAB2293L0.15V01	FCT DITTO SG/END HARNESS ORG 6 CKT 150mm	36877-0006				150	B	W	W	W	W	W	-	-	-	-	-	
1502070013	KAB2294L0.15V01	FCT DITTO SG/END HARNESS ORG 7 CKT 150mm	36877-0007				150	B	W	W	W	W	W	W	-	-	-	-	
1502070014	KAB2295L0.15V01	FCT DITTO SG/END HARNESS ORG 8 CKT 150mm	36877-0008				150	B	W	W	W	W	W	W	W	-	-	-	

RELEASED TO TOOLING/ PRODUCTION (REV A) ELEC NO: 12015-0120 2015/02/20 DRW: NCSR 2015/02/20 CHK: DANCER APPR: KPRASAD 2015/02/23	QUALITY SYMBOLS	GENERAL TOLERANCES (UNLESS SPECIFIED)	DIMENSION STYLE	SCALE	DESIGN UNITS	THIRD ANGLE PROJECTION
	▽=0	mm INCH	MM ONLY	4:1	METRIC	
	▽=0	4 PLACES ± --- ± ---	DRAWN BY DATE	TITLE		
	▽=0	3 PLACES ± --- ± ---	NCSR 2015/02/20	DITTO SINGLE-ENDED HARNESS ASSY.2 TO 8 CKT WITH 150206 SERIES WIRE		
▽=0	2 PLACES ± --- ± ---	CHECKED BY DATE	DOCUMENT NO.			
▽=0	1 PLACE ± --- ± ---	NCSR 2015/02/20	SD-150207-0001			
▽=0	0 PLACE ± --- ± ---	APPROVED BY DATE	SHEET NO.			
	ANGULAR ± --- °	KPRASAD 2015/02/23	2 OF 2			
	DRAFT WHERE APPLICABLE MUST REMAIN WITHIN DIMENSIONS	MATERIAL NO.	SEE CHART			
		SIZE 1	THIS DRAWING CONTAINS INFORMATION THAT IS PROPRIETARY TO MOLEX INCORPORATED AND SHOULD NOT BE USED WITHOUT WRITTEN PERMISSION			

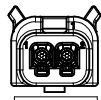
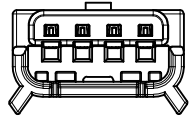

1502070001  
1502070008

CKT NO	WIRE COLOR
1	BLACK
2	WHITE

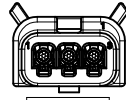

1502070002  
1502070009

CKT NO	WIRE COLOR
1	BLACK
2 & 3	WHITE

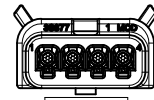

1502070003  
1502070010

CKT NO	WIRE COLOR
1	BLACK
2, 3 & 4	WHITE

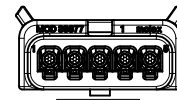

1502070004  
1502070011

CKT NO	WIRE COLOR
1	BLACK
2, 3, 4 & 5	WHITE

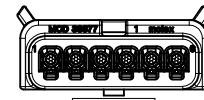

1502070005  
1502070012

CKT NO	WIRE COLOR
1	BLACK
2, 3, 4, 5 & 6	WHITE

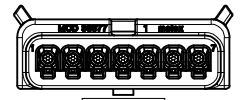

1502070006  
1502070013

CKT NO	WIRE COLOR
1	BLACK
2, 3, 4, 5, 6 & 7	WHITE

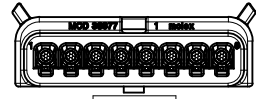

1502070007  
1502070014

CKT NO	WIRE COLOR
1	BLACK
2, 3, 4, 5, 6, 7 & 8	WHITE

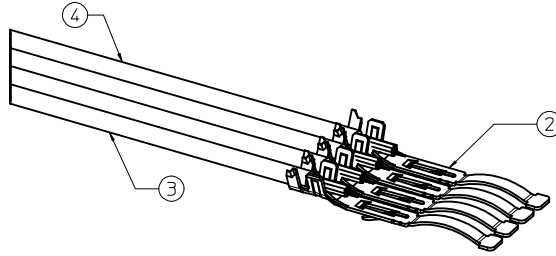

THIS VIEW IS ONLY FOR REPRESENTATION

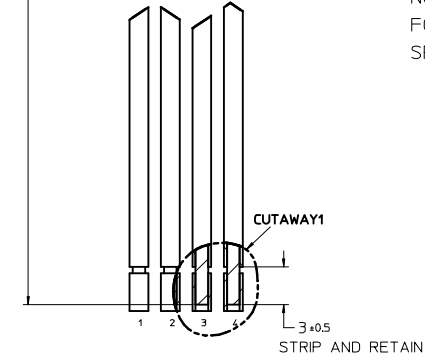
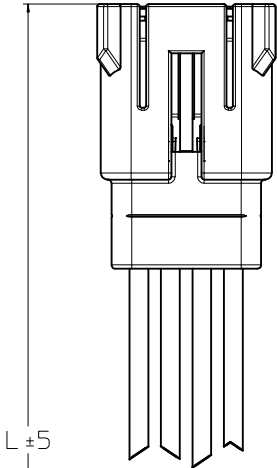
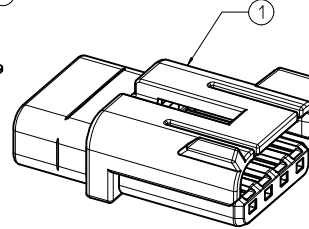

NOTE:  
FOR CRIMP SPECIFICATION AND STRIP LENGTH DETAILS, REFER APPLICATION TOOLING SPECIFICATION SHEET. DOCUMENT NO. ATS-639030200

BOM SHOWN FOR 4 CKT

ITEM NO	DESCRIPTION	PART NO	COLOR	QTY
4	UL1061, 20 AWG TINNED COPPER WIRE, BLACK	150206-0002	BLACK	1
3	UL1061, 20 AWG TINNED COPPER WIRE, WHITE	150206-0001	WHITE	3
2	DITTO GENDERLESS CRP TER HSM Cu 20-22AWG	36876-0001	NA	4
1	DITTO GENDERLESS WTW HSG FRIC LOCK 1X4	36877-0004	NA	1

QUALITY SYMBOLS	GENERAL TOLERANCES (UNLESS SPECIFIED)		DIMENSION STYLE		SCALE	DESIGN UNITS	THIRD ANGLE PROJECTION
	mm	INCH	MM ONLY	DATE			
▽=0	4 PLACES ± ---	± ---	NCSR	2015/02/20	4:1	METRIC	DITTO SINGLE-ENDED HARNESS ASSY.2 TO 8 CKT WITH 150206 SERIES WIRE <b>molex</b> DOCUMENT NO. SD-150207-0001 SHEET NO. 1 OF 2
▽=0	3 PLACES ± ---	± ---	CHECKED BY	DATE			
▽=0	2 PLACES ± ---	± ---	NCSR	2015/02/20			
▽=0	1 PLACE ± ---	± ---	APPROVED BY	DATE			
▽=0	0 PLACE ± ---	± ---	KPRASAD	2015/02/23			
	ANGULAR ± ---°		MATERIAL NO.		SEE SHEET 2		
	DRAFT WHERE APPLICABLE MUST REMAIN WITHIN DIMENSIONS		SIZE		THIS DRAWING CONTAINS INFORMATION THAT IS PROPRIETARY TO MOLEX INCORPORATED AND SHOULD NOT BE USED WITHOUT WRITTEN PERMISSION		

MOLEX P/N	FCT P/N	MATERIAL DESCRIPTION	HOUSING	TERMINAL	WIRE 1 BLACK (B)	WIRE 2 WHITE (W)	LENGTH L (mm)	CKT NO.								WIRE CUT LENGTH			
								1	2	3	4	5	6	7	8				
1502070001	KAB2289L0.3V01	FCT DITTO SG/END HARNESS ORG 2 CKT 300mm	36877-0002	36876 -0001	150206 -0002	150206 -0001	300	B	W	-	-	-	-	-	-	-	284±2		
1502070002	KAB2290L0.3V01	FCT DITTO SG/END HARNESS ORG 3 CKT 300mm	36877-0003				300	B	W	W	-	-	-	-	-	-		-	-
1502070003	KAB2291L0.3V01	FCT DITTO SG/END HARNESS ORG 4 CKT 300mm	36877-0004				300	B	W	W	W	-	-	-	-	-		-	-
1502070004	KAB2292L0.3V01	FCT DITTO SG/END HARNESS ORG 5 CKT 300mm	36877-0005				300	B	W	W	W	W	-	-	-	-		-	-
1502070005	KAB2293L0.3V01	FCT DITTO SG/END HARNESS ORG 6 CKT 300mm	36877-0006				300	B	W	W	W	W	W	-	-	-		-	-
1502070006	KAB2294L0.3V01	FCT DITTO SG/END HARNESS ORG 7 CKT 300mm	36877-0007				300	B	W	W	W	W	W	W	-	-		-	-
1502070007	KAB2295L0.3V01	FCT DITTO SG/END HARNESS ORG 8 CKT 300mm	36877-0008				150	B	W	-	-	-	-	-	-	-	-	-	134±2
1502070008	KAB2289L0.15V01	FCT DITTO SG/END HARNESS ORG 2 CKT 150mm	36877-0002				150	B	W	W	-	-	-	-	-	-	-	-	
1502070009	KAB2290L0.15V01	FCT DITTO SG/END HARNESS ORG 3 CKT 150mm	36877-0003				150	B	W	W	W	-	-	-	-	-	-	-	
1502070010	KAB2291L0.15V01	FCT DITTO SG/END HARNESS ORG 4 CKT 150mm	36877-0004				150	B	W	W	W	W	-	-	-	-	-	-	
1502070011	KAB2292L0.15V01	FCT DITTO SG/END HARNESS ORG 5 CKT 150mm	36877-0005				150	B	W	W	W	W	W	-	-	-	-	-	
1502070012	KAB2293L0.15V01	FCT DITTO SG/END HARNESS ORG 6 CKT 150mm	36877-0006				150	B	W	W	W	W	W	W	-	-	-	-	
1502070013	KAB2294L0.15V01	FCT DITTO SG/END HARNESS ORG 7 CKT 150mm	36877-0007				150	B	W	W	W	W	W	W	W	-	-	-	
1502070014	KAB2295L0.15V01	FCT DITTO SG/END HARNESS ORG 8 CKT 150mm	36877-0008				150	B	W	W	W	W	W	W	W	W	W	W	

RELEASED TO TOOLING/ PRODUCTION (REV) ELEC NO: 2015-0120 2015/02/20 DRW: NCSR 2015/02/20 CHK: DANCER 2015/02/23 APPR: KPRASAD	QUALITY SYMBOLS	GENERAL TOLERANCES (UNLESS SPECIFIED)	DIMENSION STYLE	SCALE	DESIGN UNITS	THIRD ANGLE PROJECTION
	▽=0	mm INCH	MM ONLY	4:1	METRIC	
	▽=0	4 PLACES ± --- ± ---	DRAWN BY DATE	TITLE		
	▽=0	3 PLACES ± --- ± ---	NCSR 2015/02/20	DITTO SINGLE-ENDED HARNESS ASSY.2 TO 8 CKT WITH 150206 SERIES WIRE		
▽=0	2 PLACES ± --- ± ---	CHECKED BY DATE	DOCUMENT NO.			
▽=0	1 PLACE ± --- ± ---	NCSR 2015/02/20	SD-150207-0001			
▽=0	0 PLACE ± --- ± ---	APPROVED BY DATE	SHEET NO.			
	ANGULAR ± --- °	KPRASAD 2015/02/23	2 OF 2			
	DRAFT WHERE APPLICABLE MUST REMAIN WITHIN DIMENSIONS	MATERIAL NO.	SEE CHART			
		SIZE 1	THIS DRAWING CONTAINS INFORMATION THAT IS PROPRIETARY TO MOLEX INCORPORATED AND SHOULD NOT BE USED WITHOUT WRITTEN PERMISSION			