

CKT SIZE	MATERIAL NUMBER	DIM. A REF	DIM B	DIM P
2	45984-2911	12.60	-	4.50
4	45984-4911	24.60	12.00	
6	45984-6911	36.60	24.00	
8	45984-8911	48.60	36.00	
10	45984-1911	60.60	48.00	
2	45984-2921	12.60	-	3.60
4	45984-4921	24.60	12.00	
6	45984-6921	36.60	24.00	
8	45984-8921	48.60	36.00	
10	45984-1921	60.60	48.00	
2	45984-2931	12.60	-	2.90
4	45984-4931	24.60	12.00	
6	45984-6931	36.60	24.00	
8	45984-8931	48.60	36.00	
10	45984-1931	60.60	48.00	

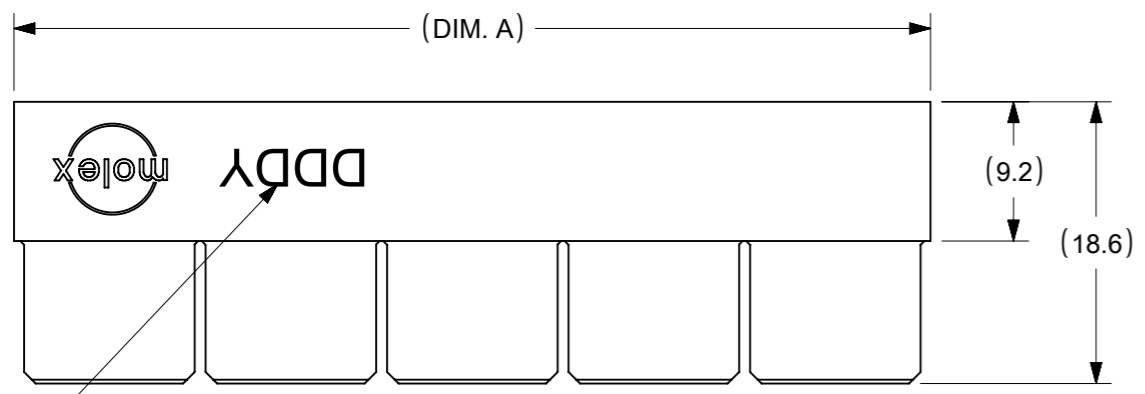

SEE NOTE 10

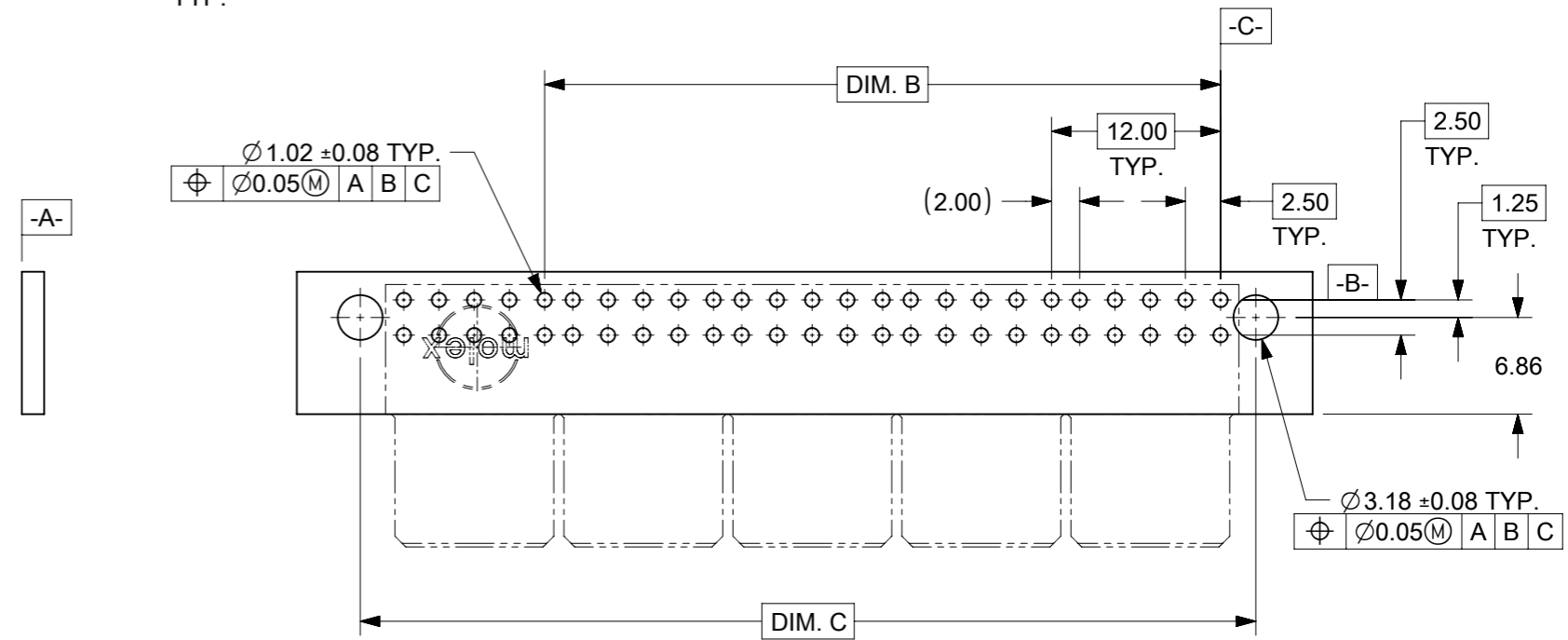
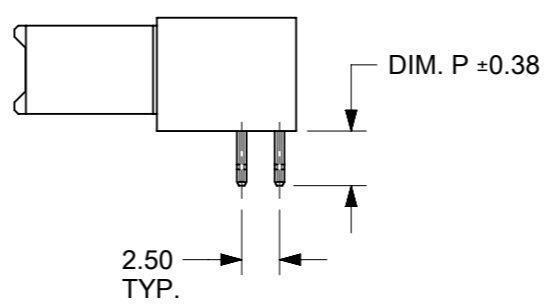
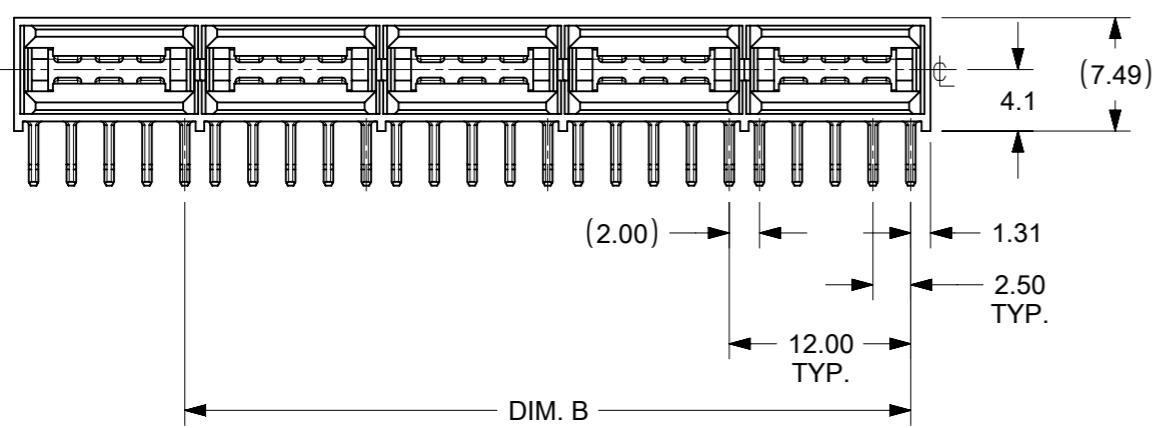

PCB LAYOUT: COMPONENT SIDE  
(PEG HOLES OPTIONAL)

- NOTES:
- MATERIAL - HOUSING: GLASS FILLED LCP (LIQUID CRYSTAL POLYMER) , UL94V-0, BLACK  
MATERIAL - POWER CONTACT: COPPER ALLOY
  - FINISH: SELECT GOLD (WITH EB-1): 0.76 MICROMETER / 30 MICROINCH MINIMUM, IN CONTACT AREA,  
SELECT TIN: 3.81 MICROMETER /150 MICROINCH MINIMUM, IN PC TAIL AREA  
BOTH OVER NICKEL: 1.27 MICROMETER / 50 MICROINCH MINIMUM. PER ES-88-229.  
TERMINALS ARE LUBRICATED WITH EB-1 LUBRICANT.
  - PRODUCT SPECIFICATION: PS-45984-001
  - PACKAGING SPECIFICATION: TRAY PER PK-45984-001
  - SEE SHEET 5 FOR CKT IDENTIFICATION
  - PARTS ARE RoHS COMPLIANT.
  - PEG HOLES ARE OPTIONAL. SEE SHEET 3 & 4.
  - MATES TO .157/.062 CARD EDGE OR MOLEX SERIES 45985.
  - PARTS CONFORM TO CLASS B REQUIREMENTS OF COSMETIC SPECIFICATION PS-45499-002.
  - DATE CODE (3-DIGIT DAY, 1-DIGIT YEAR) TO BE PRINTED AND LOCATED AS SHOWN.

THIS DRAWING CONTAINS INFORMATION THAT IS PROPRIETARY TO MOLEX ELECTRONIC TECHNOLOGIES, LLC AND SHOULD NOT BE USED WITHOUT WRITTEN PERMISSION		CURRENT REV DESC: ADDED 2 CKT		<b>molex</b>	
GENERAL TOLERANCES (UNLESS SPECIFIED)		EC NO: 646837			
DIMENSION UNITS: mm		SCALE: 2:1		PRODUCT CUSTOMER DRAWING	
4 PLACES ±		3 PLACES ±		DOCUMENT NUMBER: SD-45984-102	
2 PLACES ± 0.25		1 PLACE ± 0.38		DOC TYPE: PSD	
0 PLACES ±		ANGULAR TOL ± 0.5°		DOC PART: 001	
DRAFT WHERE APPLICABLE MUST REMAIN WITHIN DIMENSIONS		THIRD ANGLE PROJECTION		REVISION: F	
DRAWING: A3-SIZE		SERIES: 45984		SHEET NUMBER: 1 OF 5	
MATERIAL NUMBER: SEE TABLE		CUSTOMER: GENERAL MARKET			

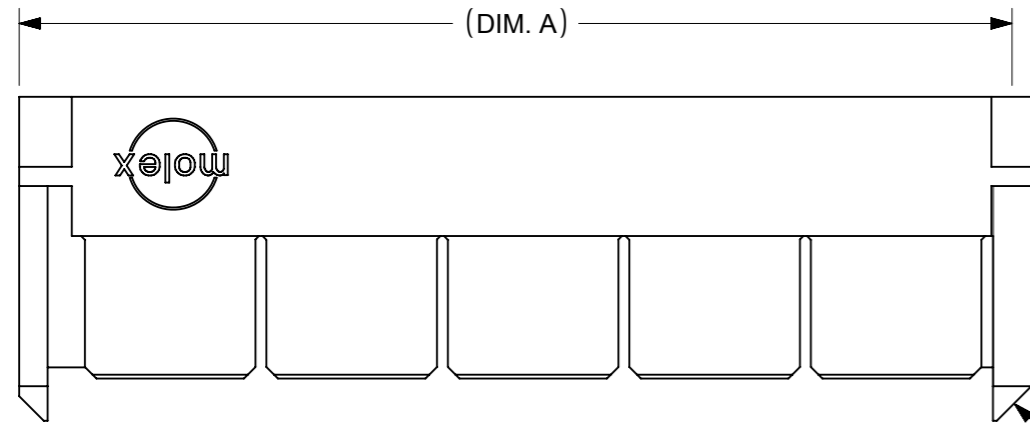

OPTIONAL GUIDES

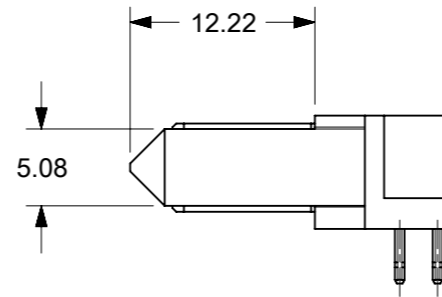
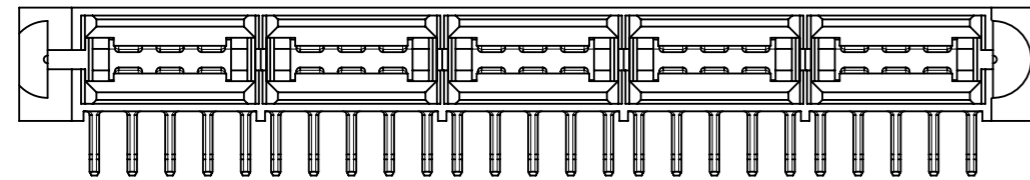

CKT SIZE	MATERIAL NUMBER	DIM. A REF	DIM B	DIM P
2	45984-2912	19.01	-	4.50
4	45984-4912	31.01	12.00	
6	45984-6912	43.01	24.00	
8	45984-8912	55.01	36.00	
10	45984-1912	67.01	48.00	
2	45984-2922	19.01	-	3.60
4	45984-4922	31.01	12.00	
6	45984-6922	43.01	24.00	
8	45984-8922	55.01	36.00	
10	45984-1922	67.01	48.00	
2	45984-2932	19.01	-	2.90
4	45984-4932	31.01	12.00	
6	45984-6932	43.01	24.00	
8	45984-8932	55.01	36.00	
10	45984-1932	67.01	48.00	

THIS DRAWING CONTAINS INFORMATION THAT IS PROPRIETARY TO MOLEX ELECTRONIC TECHNOLOGIES, LLC AND SHOULD NOT BE USED WITHOUT WRITTEN PERMISSION															
DIMENSION UNITS		SCALE		CURRENT REV DESC: ADDED 2 CKT											
mm		2:1													
GENERAL TOLERANCES (UNLESS SPECIFIED)				EC NO: 646837 DRWN: GSHARMA 2020/01/23 CHK'D: GSHARMA 2020/10/09 APPR: HTHYAGARAJ 2021/05/24 INITIAL REVISION: DRWN: BANDURA 2006/05/16 APPR: PATEL				PRODUCT CUSTOMER DRAWING							
		MM						INCH		DOCUMENT NUMBER		DOC TYPE		DOC PART	
4 PLACES		±						±		SD-45984-102		PSD		001	
3 PLACES		±						±						F	
2 PLACES		± 0.25						±							
1 PLACE		± 0.38		±											
0 PLACES		±		±											
ANGULAR TOL ± 0.5°				THIRD ANGLE PROJECTION		DRAWING		SERIES		MATERIAL NUMBER					
DRAFT WHERE APPLICABLE MUST REMAIN WITHIN DIMENSIONS						A3-SIZE		45984		SEE TABLE					
						GENERAL MARKET		CUSTOMER		SHEET NUMBER					
								2 OF 5							

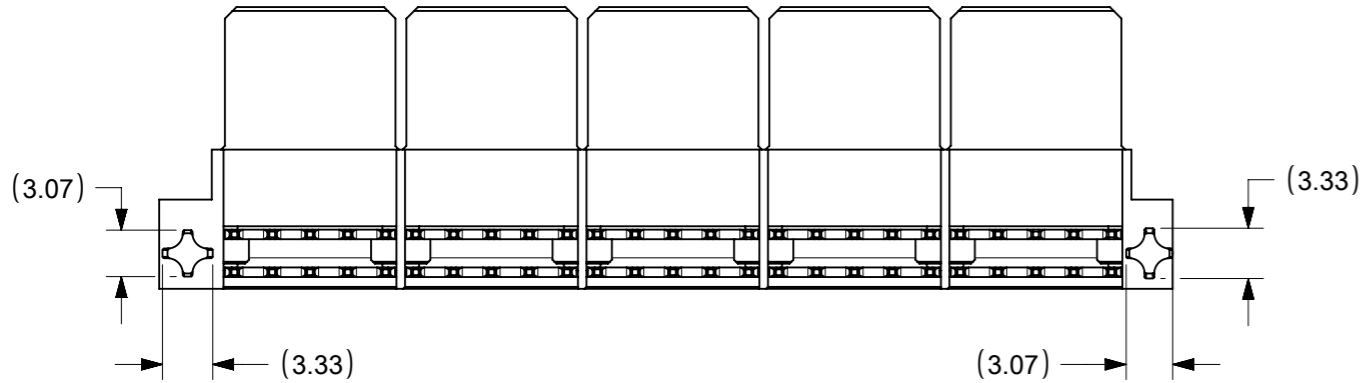
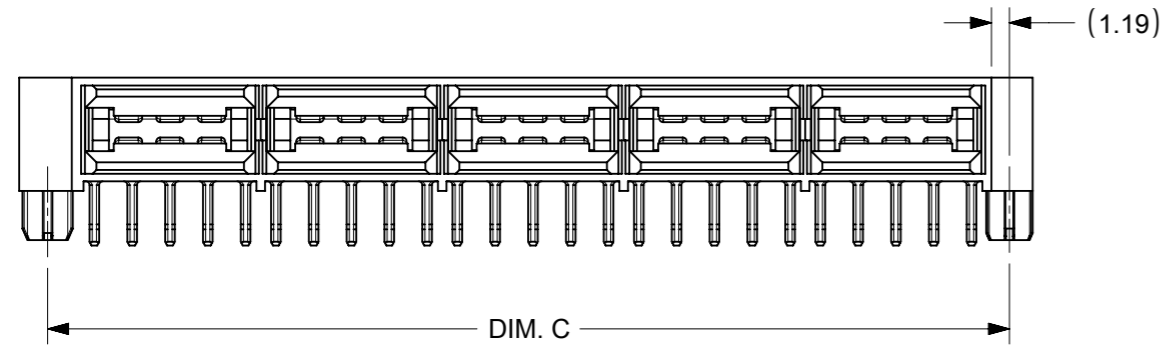
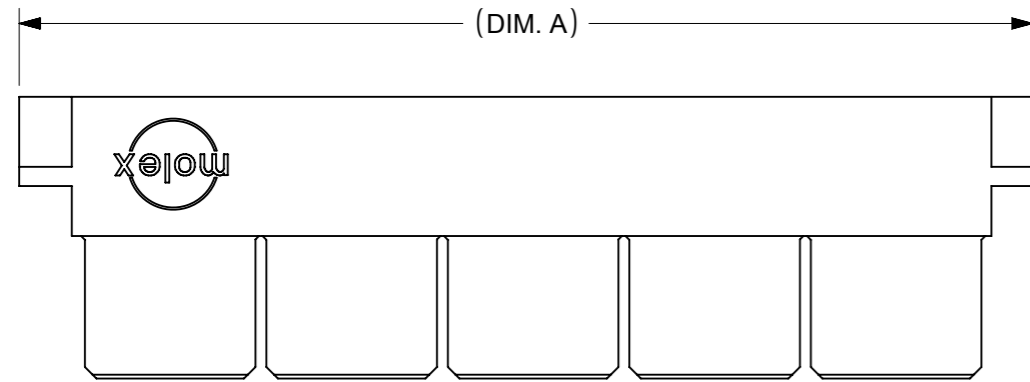

CKT SIZE	MATERIAL NUMBER	DIM. A REF	DIM B	DIM C	DIM P
2	45984-2913	19.01	-	15.60	4.50
4	45984-4913	31.01	12.00	27.60	
6	45984-6913	43.01	24.00	39.60	
8	45984-8913	55.01	36.00	51.60	
10	45984-1913	67.01	48.00	63.60	
2	45984-2923	19.01	-	15.60	3.60
4	45984-4923	31.01	12.00	27.60	
6	45984-6923	43.01	24.00	39.60	
8	45984-8923	55.01	36.00	51.60	
10	45984-1923	67.01	48.00	63.60	
2	45984-2933	19.01	-	15.60	2.90
4	45984-4933	31.01	12.00	27.60	
6	45984-6933	43.01	24.00	39.60	
8	45984-8933	55.01	36.00	51.60	
10	45984-1933	67.01	48.00	63.60	

THIS DRAWING CONTAINS INFORMATION THAT IS PROPRIETARY TO MOLEX ELECTRONIC TECHNOLOGIES, LLC AND SHOULD NOT BE USED WITHOUT WRITTEN PERMISSION		CURRENT REV DESC: ADDED 2 CKT		<b>molex</b>	
DIMENSION UNITS: mm		SCALE: 2:1			
GENERAL TOLERANCES (UNLESS SPECIFIED)				LPH RECEPTACLE ASSEMBLY RIGHT ANGLE POWER CONNECTOR	
				PRODUCT CUSTOMER DRAWING	
4 PLACES ±				EC NO: 646837	
3 PLACES ±				DRWN: GSHARMA 2020/01/23	
2 PLACES ± 0.25				CHK'D: GSHARMA 2020/10/09	
1 PLACE ± 0.38				APPR: HTHYAGARAJ 2021/05/24	
0 PLACES ±				INITIAL REVISION:	
ANGULAR TOL ± 0.5°				DRWN: BANDURA 2006/05/16	
DRAFT WHERE APPLICABLE MUST REMAIN WITHIN DIMENSIONS				APPR: PATEL	
DOCUMENT STATUS: P1		RELEASE DATE: 2021/05/24 08:17:38		DOCUMENT NUMBER: SD-45984-102	
				DOC TYPE: PSD	
				DOC PART: 001	
				REVISION: F	
				SHEET NUMBER: 3 OF 5	

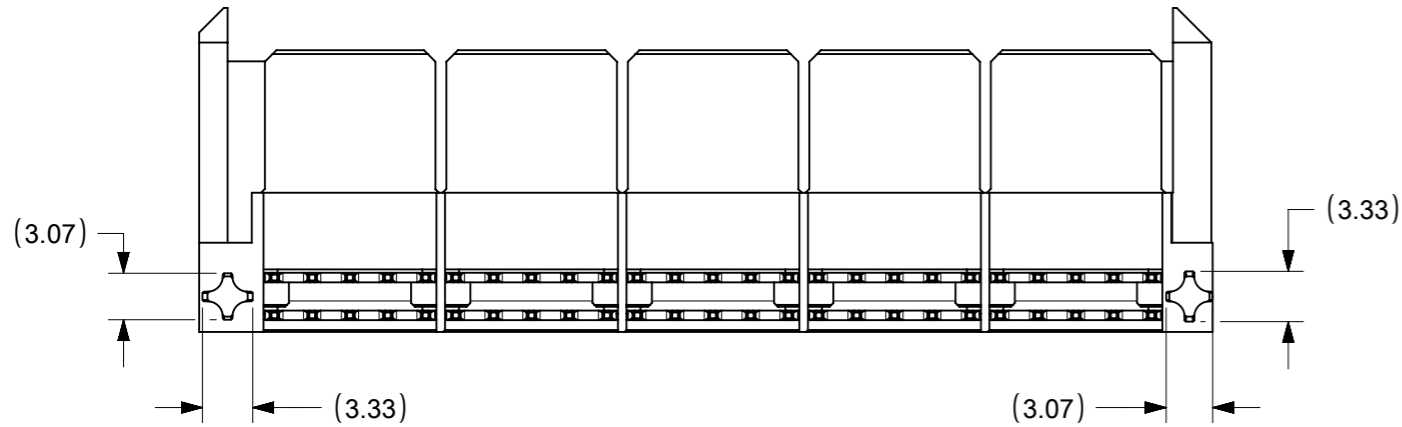
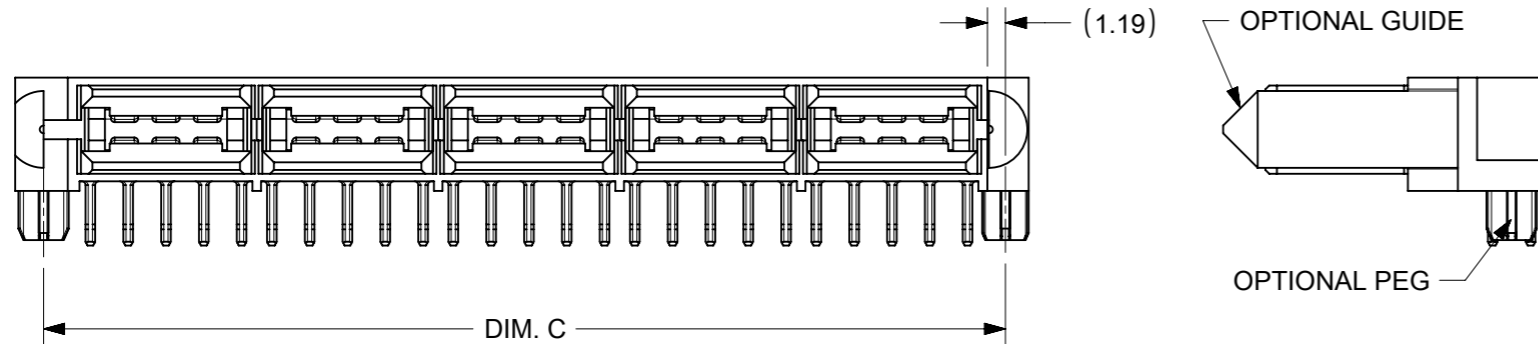
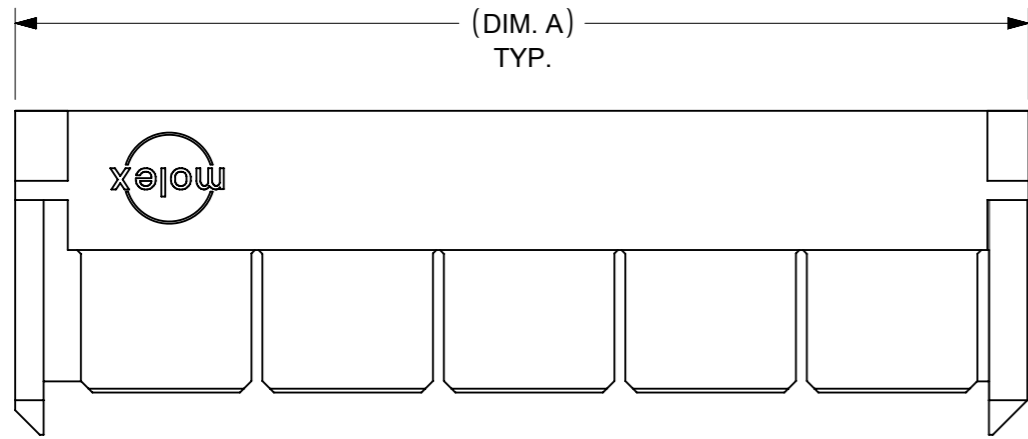

CKT SIZE	MATERIAL NUMBER	DIM. A REF	DIM B	DIM C	DIM P
2	45984-2914	19.01	-	15.60	4.50
4	45984-4914	31.01	12.00	27.60	
6	45984-6914	43.01	24.00	39.60	
8	45984-8914	55.01	36.00	51.60	
10	45984-1914	67.01	48.00	63.60	
2	45984-2924	19.01	-	15.60	3.60
4	45984-4924	31.01	12.00	27.60	
6	45984-6924	43.01	24.00	39.60	
8	45984-8924	55.01	36.00	51.60	
10	45984-1924	67.01	48.00	63.60	2.90
2	45984-2934	19.01	-	15.60	
4	45984-4934	31.01	12.00	27.60	
6	45984-6934	43.01	24.00	39.60	
8	45984-8934	55.01	36.00	51.60	
10	45984-1934	67.01	48.00	63.60	

THIS DRAWING CONTAINS INFORMATION THAT IS PROPRIETARY TO MOLEX ELECTRONIC TECHNOLOGIES, LLC AND SHOULD NOT BE USED WITHOUT WRITTEN PERMISSION												
DIMENSION UNITS		SCALE		CURRENT REV DESC: ADDED 2 CKT				<b>molex</b>				
mm		2:1										
GENERAL TOLERANCES (UNLESS SPECIFIED)				EC NO: 646837 DRWN: GSHARMA 2020/01/23 CHK'D: GSHARMA 2020/10/09 APPR: HTHYAGARAJ 2021/05/24 INITIAL REVISION: DRWN: BANDURA 2006/05/16 APPR: PATEL				PRODUCT CUSTOMER DRAWING				
4 PLACES		±	±					DOCUMENT NUMBER		DOC TYPE	DOC PART	REVISION
3 PLACES		±	±					SD-45984-102		PSD	001	F
2 PLACES		±	0.25									
1 PLACE		±	0.38									
0 PLACES		±	±									
ANGULAR TOL		± 0.5°		DRAFT WHERE APPLICABLE MUST REMAIN WITHIN DIMENSIONS		THIRD ANGLE PROJECTION		DRAWING	SHEET NUMBER			
						A3-SIZE		SERIES	45984			
						MATERIAL NUMBER		CUSTOMER	SEE TABLE			
						GENERAL MARKET		4 OF 5				

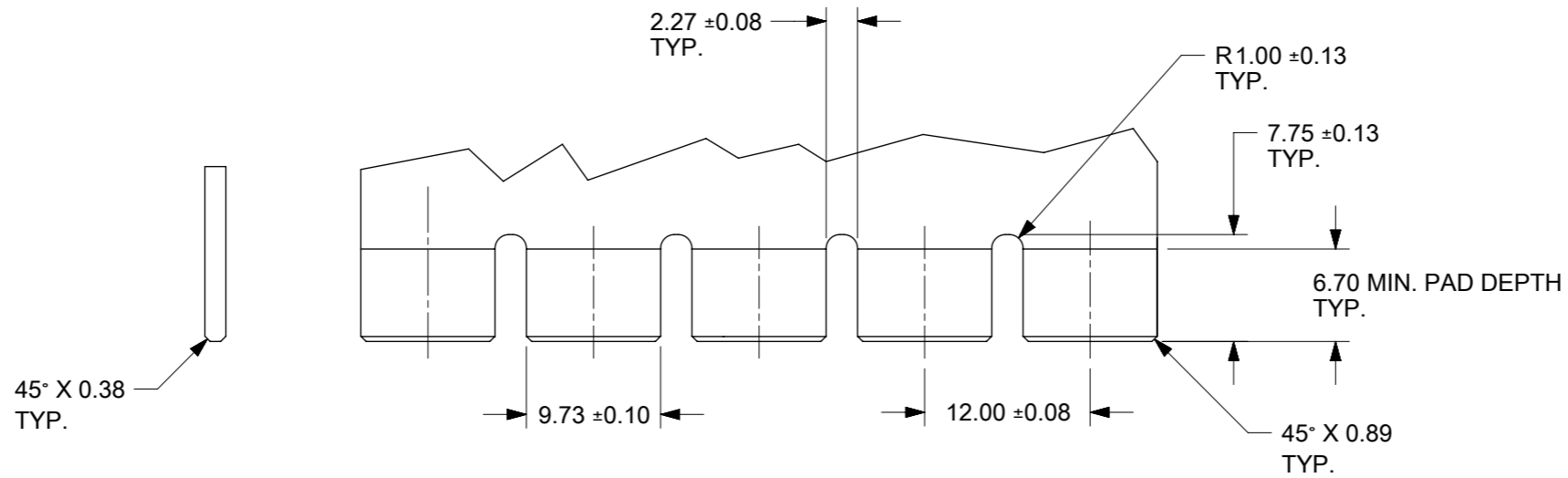
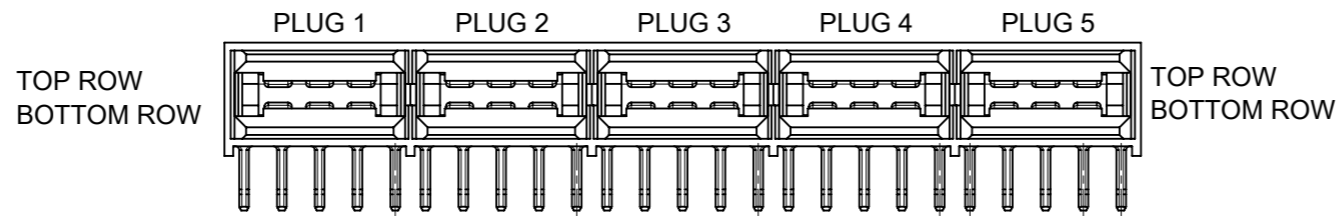

RECOMMENDED  
EDGE CARD LAYOUT  
THICKNESS: 1.57/0.062±0.15/0.006

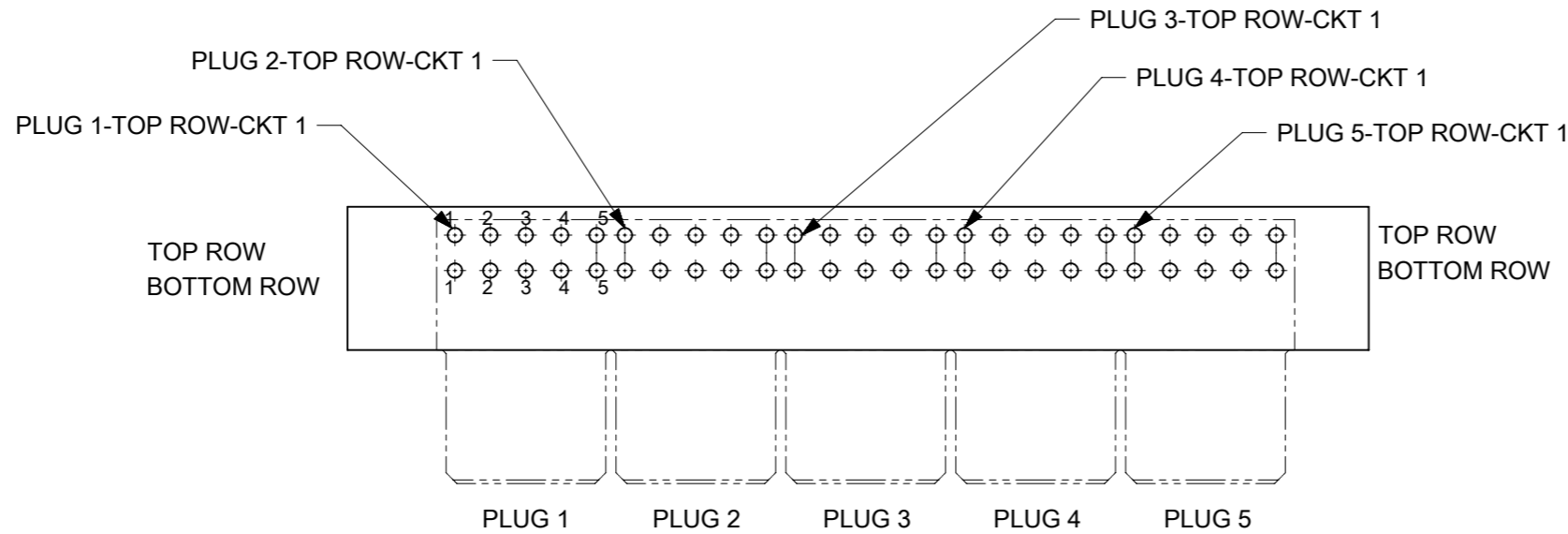

PCB LAYOUT: COMPONENT SIDE  
SEE SHEET 1 FOR DIMENSIONS

THIS DRAWING CONTAINS INFORMATION THAT IS PROPRIETARY TO MOLEX ELECTRONIC TECHNOLOGIES, LLC AND SHOULD NOT BE USED WITHOUT WRITTEN PERMISSION									
DIMENSION UNITS		SCALE		CURRENT REV DESC: ADDED 2 CKT				<b>molex</b>	
mm		2:1							
GENERAL TOLERANCES (UNLESS SPECIFIED)									
		MM		INCH					
4 PLACES		±		±		EC NO: 646837			
3 PLACES		±		±		DRWN: GSHARMA 2020/01/23			
2 PLACES		± 0.25		±		CHK'D: GSHARMA 2020/10/09			
1 PLACE		± 0.38		±		APPR: HTHYAGARAJ 2021/05/24			
0 PLACES		±		±		INITIAL REVISION:			
ANGULAR TOL		± 0.5°		±		DRWN: BANDURA 2006/05/16			
DRAFT WHERE APPLICABLE MUST REMAIN WITHIN DIMENSIONS		THIRD ANGLE PROJECTION		DRAWING		SERIES		MATERIAL NUMBER	
				A3-SIZE		45984		SEE TABLE	
						CUSTOMER		SHEET NUMBER	
						GENERAL MARKET		5 OF 5	

DOCUMENT STATUS	P1	RELEASE DATE	2021/05/24	08:17:38
-----------------	----	--------------	------------	----------