

NO. OF CKTS	DIM A	DIM B
2	.100/2.54	.200/5.08
3	.200/5.08	.300/7.62
4	.300/7.62	.400/10.16
5	.400/10.16	.500/12.70
6	.500/12.70	.600/15.24
7	.600/15.24	.700/17.78
8	.700/17.78	.800/20.32
9	.800/20.32	.900/22.86
10	.900/22.86	1.000/25.40
11	1.000/25.40	1.100/27.94
12	1.100/27.94	1.200/30.48
13	1.200/30.48	1.300/33.02
14	1.300/33.02	1.400/35.56
15	1.400/35.56	1.500/38.10
16	1.500/38.10	1.600/40.64
17	1.600/40.64	1.700/43.18
18	1.700/43.18	1.800/45.72
19	1.800/45.72	1.900/48.26
20	1.900/48.26	2.000/50.80
21	2.000/50.80	2.100/53.34
22	2.100/53.34	2.200/55.88
23	2.200/55.88	2.300/58.42
24	2.300/58.42	2.400/60.96
25	2.400/60.96	2.500/63.50
26	2.500/63.50	2.600/66.04
27	2.600/66.04	2.700/68.58
28	2.700/68.58	2.800/71.12
29	2.800/71.12	2.900/73.66
30	2.900/73.66	3.000/76.20
31	3.000/76.20	3.100/78.74
32	3.100/78.74	3.200/81.28
33	3.200/81.28	3.300/83.82
34	3.300/83.82	3.400/86.36
35	3.400/86.36	3.500/88.90
36	3.500/88.90	3.600/91.44

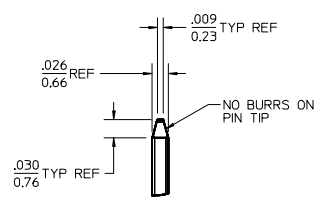

DETAIL X  
SCALE 5:1  
SEE NOTE 10

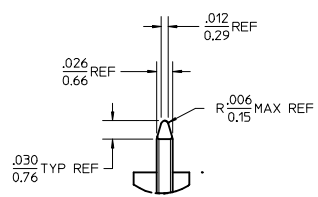

DETAIL Y  
SCALE 5:1  
SEE NOTE 10

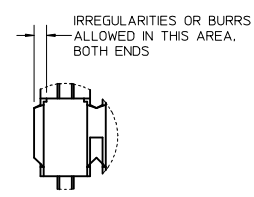

DETAIL Z  
SCALE 5:1

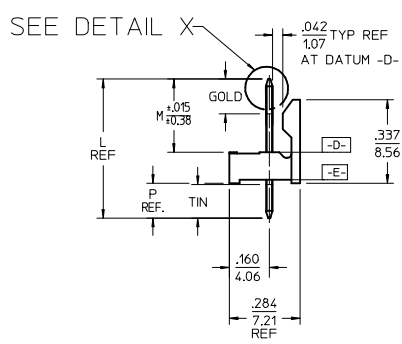
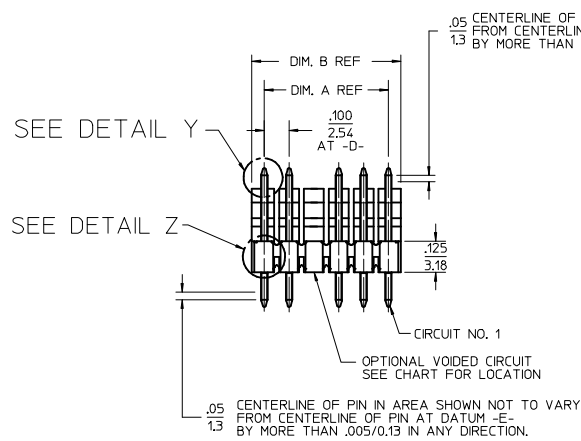
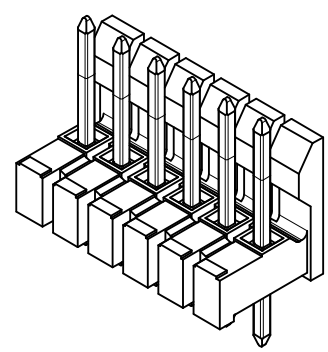

- NOTES:
- MATERIAL: NYLON, 94V-0, COLOR: BLACK
  - FINISH:
    - (154) OVERALL TIN: .000100/0.00254 MIN. OVER NICKEL: .000050/0.00127 MIN.
    - (208) SELECT GOLD: .000015/0.00038 MIN. SELECT TIN: .000100/0.00254 MIN. WITH OVERALL NICKEL UNDERPLATE: .000050/0.00127 MIN.
    - (228) SELECT GOLD: .000030/0.00076 MIN. SELECT TIN: .000100/0.00254 MIN. WITH OVERALL NICKEL UNDERPLATE: .000050/0.00127 MIN.
  - PRODUCT SPECIFICATION PS 10-07.
  - PACKAGING INFORMATION: SEE TABLES
  - SOLDERABILITY PER SMES-152.
  - PIN PUSH OUT FORCE: 3 LBS. MIN
  - KINK PIN OPTION NOT RECOMMENDED FOR 2 CIRCUIT PARTS. HOLE SIZE MAY NEED TO BE ADJUSTED ON 2 CIRCUIT PARTS WITH KINK OPTION FOR PROPER INSERTION INTO THE PCB. SEE SMES-42003 FOR ADDITIONAL INFORMATION ON KINK PIN DIRECTION AND PLACEMENT.
  - HEADERS ARE NOT STACKABLE ON .100/2.54 CENTERS.
  - PARTS CONFORM TO CLASS 'B' REQUIREMENTS OF COSMETIC SPECIFICATION PS-45499-002.
  - PIN TIP DIMENSIONS ARE SHOWN FOR REFERENCE ONLY. DIMENSIONS APPLY PRIOR TO PLATING OR ASSEMBLY.
  - FIRST AND LAST CIRCUIT BACKWALLS MUST BE REMOVED WHEN MATING TO A PART WITH POLARIZING RIBS.

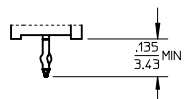

KINKED PIN OPTION  
SEE NOTE 7

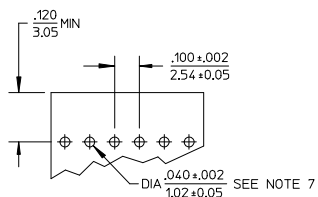

RECOMMENDED PC BOARD LAYOUT

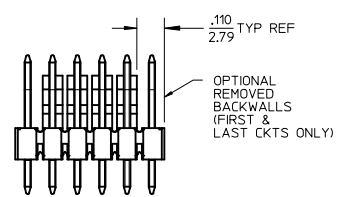

REMOVED BACKWALLS OPTION  
SEE NOTE 11

<b>ADD NOTE 11</b> EC NO: UCP2014-1471 DRW:HKIPPER 2013/10/01 CHKD:ANDERSON 2013/10/01 APPR:FSMITH 2013/10/09	QUALITY SYMBOLS $\nabla Z=0$ $\nabla E=0$ $\nabla F=0$	GENERAL TOLERANCES (UNLESS SPECIFIED)		DIMENSION STYLE		SCALE	DESIGN UNITS	THIRD ANGLE PROJECTION		
				IN/MM		2:1	INCH			
				mm	INCH	DRAWN BY	DATE	TITLE		
				4 PLACES ± --- ± ---	3 PLACES ± --- ± .010	JSCHAFFER	2004/03/18	.100 FRICTION LOCK BREAKAWAY HEADER ASSY		
		2 PLACES ± 0.25 ± .014	1 PLACE ± 0.36 ± ---	KSAMIEC	2004/03/18	molex				
		0 PLACE ± ±		MARGULIS	2004/03/18	SD-42227-002				
		ANGULAR ±1/2° DRAFT WHERE APPLICABLE MUST REMAIN WITHIN DIMENSIONS		MATERIAL NO.		DOCUMENT NO.		SHEET NO.		
				SEE CHART				1 OF *		
				SIZE B		THIS DRAWING CONTAINS INFORMATION THAT IS PROPRIETARY TO MOLEX INCORPORATED AND SHOULD NOT BE USED WITHOUT WRITTEN PERMISSION				



A-42227-0213/0246					
HEADER NUMBER:		41411			
PLATING:		154			
PIN LENGTH: L		.540/13.72			
MATING LENGTH: M		.295/7.49			
GOLD POINT: G		N/A			
PC TAIL LENGTH: P		.120/3.05			
TIN: T		OVERALL			
CKTS:		3-36			
KINKS:		NO			
REMOVED BACKWALLS:		YES			
VOIDED CKTS:		NONE			
PACKAGING:		BULK, PER PK-40873-0056			
CKTS	MATERIAL NUMBER	ENG NUMBER	CKTS	MATERIAL NUMBER	ENG NUMBER
02			20	22-28-0206	A-42227-0230
03	22-28-0036	A-42227-0213	21	22-28-0216	A-42227-0231
04	22-28-0046	A-42227-0214	22	22-28-0226	A-42227-0232
05	22-28-0056	A-42227-0215	23	22-28-0236	A-42227-0233
06	22-28-0066	A-42227-0216	24	22-28-0246	A-42227-0234
07	22-28-0076	A-42227-0217	25	22-28-0256	A-42227-0235
08	22-28-0086	A-42227-0218	26	22-28-0266	A-42227-0236
09	22-28-0096	A-42227-0219	27	22-28-0276	A-42227-0237
10	22-28-0106	A-42227-0220	28	22-28-0286	A-42227-0238
11	22-28-0116	A-42227-0221	29	22-28-0296	A-42227-0239
12	22-28-0126	A-42227-0222	30	22-28-0306	A-42227-0240
13	22-28-0136	A-42227-0223	31	22-28-0316	A-42227-0241
14	22-28-0146	A-42227-0224	32	22-28-0326	A-42227-0242
15	22-28-0156	A-42227-0225	33	22-28-0336	A-42227-0243
16	22-28-0166	A-42227-0226	34	22-28-0346	A-42227-0244
17	22-28-0176	A-42227-0227	35	22-28-0356	A-42227-0245
18	22-28-0186	A-42227-0228	36	22-28-0366	A-42227-0246
19	22-28-0196	A-42227-0229			

A-42227-0248/0281					
HEADER NUMBER:		41411			
PLATING:		208			
PIN LENGTH: L		.540/13.72			
MATING LENGTH: M		.295/7.49			
GOLD POINT: G		.140/3.56			
PC TAIL LENGTH: P		.120/3.05			
TIN: T		.135/3.43			
CKTS:		3-36			
KINKS:		NO			
REMOVED BACKWALLS:		YES			
VOIDED CKTS:		NONE			
PACKAGING:		BULK, PER PK-40873-0056			
CKTS	MATERIAL NUMBER	ENG NUMBER	CKTS	MATERIAL NUMBER	ENG NUMBER
02			20	22-28-0207	A-42227-0265
03	22-28-0037	A-42227-0248	21	22-28-0217	A-42227-0266
04	22-28-0047	A-42227-0249	22	22-28-0227	A-42227-0267
05	22-28-0057	A-42227-0250	23	22-28-0237	A-42227-0268
06	22-28-0067	A-42227-0251	24	22-28-0247	A-42227-0269
07	22-28-0077	A-42227-0252	25	22-28-0257	A-42227-0270
08	22-28-0087	A-42227-0253	26	22-28-0267	A-42227-0271
09	22-28-0097	A-42227-0254	27	22-28-0277	A-42227-0272
10	22-28-0107	A-42227-0255	28	22-28-0287	A-42227-0273
11	22-28-0117	A-42227-0256	29	22-28-0297	A-42227-0274
12	22-28-0127	A-42227-0257	30	22-28-0307	A-42227-0275
13	22-28-0137	A-42227-0258	31	22-28-0317	A-42227-0276
14	22-28-0147	A-42227-0259	32	22-28-0327	A-42227-0277
15	22-28-0157	A-42227-0260	33	22-28-0337	A-42227-0278
16	22-28-0167	A-42227-0261	34	22-28-0347	A-42227-0279
17	22-28-0177	A-42227-0262	35	22-28-0357	A-42227-0280
18	22-28-0187	A-42227-0263	36	22-28-0367	A-42227-0281
19	22-28-0197	A-42227-0264			

<b>REV:</b> <b>K5</b>	<u>ECR/ECN INFORMATION:</u>	<u>TITLE:</u> <b>.100 FRICTION LOCK BREAKAWAY HEADER ASSY.</b>	<u>SHEET No.</u> <b>- 2 -</b>
	EC No.: <b>UCP2012-3374</b> DATE: <b>10/12/2012</b>		
<u>DOCUMENT NUMBER:</u> <b>SD- 42227 -002</b>	<u>CREATED / REVISED BY:</u> <b>MKIPPER</b>	<u>CHECKED BY:</u> <b>JBELL</b>	<u>APPROVED BY:</u> <b>FSMITH-ROEMER</b>



A-42227-0283/0316					
HEADER NUMBER:		41411			
PLATING:		228			
PIN LENGTH: L		.540/13.72			
MATING LENGTH: M		.295/7.49			
GOLD POINT: G		.140/3.56			
PC TAIL LENGTH: P		.120/3.05			
TIN: T		.135/3.43			
CKTS:		3-36			
KINKS:		NO			
REMOVED BACKWALLS:		YES			
VOIDED CKTS:		NONE			
PACKAGING:		BULK, PER PK-40873-0056			
CKTS	MATERIAL NUMBER	ENG NUMBER	CKTS	MATERIAL NUMBER	ENG NUMBER
02			20	22-28-0208	A-42227-0300
03	22-28-0038	A-42227-0283	21	22-28-0218	A-42227-0301
04	22-28-0048	A-42227-0284	22	22-28-0228	A-42227-0302
05	22-28-0058	A-42227-0285	23	22-28-0238	A-42227-0303
06	22-28-0068	A-42227-0286	24	22-28-0248	A-42227-0304
07	22-28-0078	A-42227-0287	25	22-28-0258	A-42227-0305
08	22-28-0088	A-42227-0288	26	22-28-0268	A-42227-0306
09	22-28-0098	A-42227-0289	27	22-28-0278	A-42227-0307
10	22-28-0108	A-42227-0290	28	22-28-0288	A-42227-0308
11	22-28-0118	A-42227-0291	29	22-28-0298	A-42227-0309
12	22-28-0128	A-42227-0292	30	22-28-0308	A-42227-0310
13	22-28-0138	A-42227-0293	31	22-28-0318	A-42227-0311
14	22-28-0148	A-42227-0294	32	22-28-0328	A-42227-0312
15	22-28-0158	A-42227-0295	33	22-28-0338	A-42227-0313
16	22-28-0168	A-42227-0296	34	22-28-0348	A-42227-0314
17	22-28-0178	A-42227-0297	35	22-28-0358	A-42227-0315
18	22-28-0188	A-42227-0298	36	22-28-0368	A-42227-0316
19	22-28-0198	A-42227-0299			

A-42227-0318/0351					
HEADER NUMBER:		41411			
PLATING:		154			
PIN LENGTH: L		.555/14.10			
MATING LENGTH: M		.295/7.49			
GOLD POINT: G		N/A			
PC TAIL LENGTH: P		.135/3.43			
TIN: T		OVERALL			
CKTS:		3-36			
KINKS:		YES			
REMOVED BACKWALLS:		YES			
VOIDED CKTS:		NONE			
PACKAGING:		BULK, PER PK-40873-0056			
CKTS	MATERIAL NUMBER	ENG NUMBER	CKTS	MATERIAL NUMBER	ENG NUMBER
02			20	22-28-0209	A-42227-0335
03	22-28-0039	A-42227-0318	21	22-28-0219	A-42227-0336
04	22-28-0049	A-42227-0319	22	22-28-0229	A-42227-0337
05	22-28-0059	A-42227-0320	23	22-28-0239	A-42227-0338
06	22-28-0069	A-42227-0321	24	22-28-0249	A-42227-0339
07	22-28-0079	A-42227-0322	25	22-28-0259	A-42227-0340
08	22-28-0089	A-42227-0323	26	22-28-0269	A-42227-0341
09	22-28-0099	A-42227-0324	27	22-28-0279	A-42227-0342
10	22-28-0109	A-42227-0325	28	22-28-0289	A-42227-0343
11	22-28-0119	A-42227-0326	29	22-28-0299	A-42227-0344
12	22-28-0129	A-42227-0327	30	22-28-0309	A-42227-0345
13	22-28-0139	A-42227-0328	31	22-28-0319	A-42227-0346
14	22-28-0149	A-42227-0329	32	22-28-0329	A-42227-0347
15	22-28-0159	A-42227-0330	33	22-28-0339	A-42227-0348
16	22-28-0169	A-42227-0331	34	22-28-0349	A-42227-0349
17	22-28-0179	A-42227-0332	35	22-28-0359	A-42227-0350
18	22-28-0189	A-42227-0333	36	22-28-0369	A-42227-0351
19	22-28-0199	A-42227-0334			

<b>REV:</b> <b>K5</b>	<u>ECR/ECN INFORMATION:</u>	<u>TITLE:</u> <b>.100 FRICTION LOCK BREAKAWAY HEADER ASSY.</b>	<u>SHEET No.</u> <b>- 3 -</b>
	EC No.: <b>UCP2012-3374</b> DATE: <b>10/12/2012</b>		
<u>DOCUMENT NUMBER:</u> <b>SD- 42227 -002</b>	<u>CREATED / REVISED BY:</u> <b>MKIPPER</b>	<u>CHECKED BY:</u> <b>JBELL</b>	<u>APPROVED BY:</u> <b>FSMITH-ROEMER</b>



A-42227-0422/0455					
HEADER NUMBER:		41411			
PLATING:		228			
PIN LENGTH: L		.540/13.72			
MATING LENGTH: M		.295/7.49			
GOLD POINT: G		.140/3.56			
PC TAIL LENGTH: P		.120/3.05			
TIN: T		.135/3.43			
CKTS:		3-36			
KINKS:		NO			
REMOVED BACKWALLS:		YES			
VOIDED CKTS:		3			
PACKAGING:		BULK, PER PK-40873-0056			
CKTS	MATERIAL NUMBER	ENG NUMBER	CKTS	MATERIAL NUMBER	ENG NUMBER
02			20	42227-0439	A-42227-0439
03	42227-0422	A-42227-0422	21	42227-0440	A-42227-0440
04	42227-0423	A-42227-0423	22	42227-0441	A-42227-0441
05	42227-0424	A-42227-0424	23	42227-0442	A-42227-0442
06	42227-0425	A-42227-0425	24	42227-0443	A-42227-0443
07	22-29-0070	A-42227-0426	25	42227-0444	A-42227-0444
08	42227-0427	A-42227-0427	26	42227-0445	A-42227-0445
09	42227-0428	A-42227-0428	27	42227-0446	A-42227-0446
10	42227-0429	A-42227-0429	28	42227-0447	A-42227-0447
11	42227-0430	A-42227-0430	29	42227-0448	A-42227-0448
12	42227-0431	A-42227-0431	30	42227-0449	A-42227-0449
13	42227-0432	A-42227-0432	31	42227-0450	A-42227-0450
14	42227-0433	A-42227-0433	32	42227-0451	A-42227-0451
15	42227-0434	A-42227-0434	33	42227-0452	A-42227-0452
16	42227-0435	A-42227-0435	34	42227-0453	A-42227-0453
17	42227-0436	A-42227-0436	35	42227-0454	A-42227-0454
18	42227-0437	A-42227-0437	36	42227-0455	A-42227-0455
19	42227-0438	A-42227-0438			

A-42227-0456/0487					
HEADER NUMBER:		41411			
PLATING:		228			
PIN LENGTH: L		.540/13.72			
MATING LENGTH: M		.295/7.49			
GOLD POINT: G		.140/3.56			
PC TAIL LENGTH: P		.120/3.05			
TIN: T		.135/3.43			
CKTS:		5-36			
KINKS:		NO			
REMOVED BACKWALLS:		YES			
VOIDED CKTS:		5			
PACKAGING:		BULK, PER PK-40873-0056			
CKTS	MATERIAL NUMBER	ENG NUMBER	CKTS	MATERIAL NUMBER	ENG NUMBER
02			20	42227-0471	A-42227-0471
03			21	42227-0472	A-42227-0472
04			22	42227-0473	A-42227-0473
05	42227-0456	A-42227-0456	23	42227-0474	A-42227-0474
06	42227-0457	A-42227-0457	24	42227-0475	A-42227-0475
07	42227-0458	A-42227-0458	25	42227-0476	A-42227-0476
08	42227-0459	A-42227-0459	26	42227-0477	A-42227-0477
09	42227-0460	A-42227-0460	27	42227-0478	A-42227-0478
10	22-29-0101	A-42227-0461	28	42227-0479	A-42227-0479
11	22-29-0111	A-42227-0462	29	42227-0480	A-42227-0480
12	42227-0463	A-42227-0463	30	42227-0481	A-42227-0481
13	42227-0464	A-42227-0464	31	42227-0482	A-42227-0482
14	42227-0465	A-42227-0465	32	42227-0483	A-42227-0483
15	42227-0466	A-42227-0466	33	42227-0484	A-42227-0484
16	42227-0467	A-42227-0467	34	42227-0485	A-42227-0485
17	42227-0468	A-42227-0468	35	42227-0486	A-42227-0486
18	42227-0469	A-42227-0469	36	42227-0487	A-42227-0487
19	42227-0470	A-42227-0470			

REV: <b>K5</b>	<u>ECR/ECN INFORMATION:</u>		<u>TITLE:</u> <b>.100 FRICTION LOCK BREAKAWAY HEADER ASSY.</b>	<u>SHEET No.</u> <b>- 4 -</b>
	EC No.:	<b>UCP2012-3374</b>		
	DATE:	<b>10/12/2012</b>		
<u>DOCUMENT NUMBER:</u> <b>SD- 42227 -002</b>		<u>CREATED / REVISED BY:</u> <b>MKIPPER</b>	<u>CHECKED BY:</u> <b>JBELL</b>	<u>APPROVED BY:</u> <b>FSMITH-ROEMER</b>



A-42227-0488/0521					
HEADER NUMBER:	41411				
PLATING:	154				
PIN LENGTH: L	.555/14.10				
MATING LENGTH: M	.295/7.49				
GOLD POINT: G	N/A				
PC TAIL LENGTH: P	.135/3.43				
TIN: T	OVERALL				
CKTS:	3-36				
KINKS:	YES				
REMOVED BACKWALLS:	YES				
VOIDED CKTS:	2				
PACKAGING:	BULK, PER PK-40873-0056				
CKTS	MATERIAL NUMBER	ENG NUMBER	CKTS	MATERIAL NUMBER	ENG NUMBER
02			20	22-29-0202	A-42227-0505
03	22-29-0032	A-42227-0488	21	22-29-0212	A-42227-0506
04	22-29-0042	A-42227-0489	22	22-29-0222	A-42227-0507
05	22-29-0052	A-42227-0490	23	22-29-0232	A-42227-0508
06	22-29-0062	A-42227-0491	24	22-29-0242	A-42227-0509
07	22-29-0072	A-42227-0492	25	22-29-0252	A-42227-0510
08	22-29-0082	A-42227-0493	26	22-29-0262	A-42227-0511
09	22-29-0092	A-42227-0494	27	22-29-0272	A-42227-0512
10	22-29-0102	A-42227-0495	28	22-29-0282	A-42227-0513
11	22-29-0112	A-42227-0496	29	22-29-0292	A-42227-0514
12	22-29-0122	A-42227-0497	30	22-29-0302	A-42227-0515
13	22-29-0132	A-42227-0498	31	22-29-0312	A-42227-0516
14	22-29-0142	A-42227-0499	32	22-29-0322	A-42227-0517
15	22-29-0152	A-42227-0500	33	22-29-0332	A-42227-0518
16	22-29-0162	A-42227-0501	34	22-29-0342	A-42227-0519
17	22-29-0172	A-42227-0502	35	22-29-0352	A-42227-0520
18	22-29-0182	A-42227-0503	36	22-29-0362	A-42227-0521
19	22-29-0192	A-42227-0504			

A-42227-0522/0555					
HEADER NUMBER:	41411				
PLATING:	154				
PIN LENGTH: L	.540/13.72				
MATING LENGTH: M	.295/7.49				
GOLD POINT: G	N/A				
PC TAIL LENGTH: P	.120/3.05				
TIN: T	OVERALL				
CKTS:	3-36				
KINKS:	NO				
REMOVED BACKWALLS:	YES				
VOIDED CKTS:	2				
PACKAGING:	BULK, PER PK-40873-0056				
CKTS	MATERIAL NUMBER	ENG NUMBER	CKTS	MATERIAL NUMBER	ENG NUMBER
02			20	42227-0539	A-42227-0539
03	42227-0522	A-42227-0522	21	42227-0540	A-42227-0540
04	42227-0523	A-42227-0523	22	42227-0541	A-42227-0541
05	42227-0524	A-42227-0524	23	42227-0542	A-42227-0542
06	42227-0525	A-42227-0525	24	42227-0543	A-42227-0543
07	42227-0526	A-42227-0526	25	42227-0544	A-42227-0544
08	42227-0527	A-42227-0527	26	42227-0545	A-42227-0545
09	42227-0528	A-42227-0528	27	42227-0546	A-42227-0546
10	42227-0529	A-42227-0529	28	42227-0547	A-42227-0547
11	42227-0530	A-42227-0530	29	42227-0548	A-42227-0548
12	42227-0531	A-42227-0531	30	42227-0549	A-42227-0549
13	42227-0532	A-42227-0532	31	42227-0550	A-42227-0550
14	42227-0533	A-42227-0533	32	42227-0551	A-42227-0551
15	42227-0534	A-42227-0534	33	42227-0552	A-42227-0552
16	42227-0535	A-42227-0535	34	42227-0553	A-42227-0553
17	42227-0536	A-42227-0536	35	42227-0554	A-42227-0554
18	42227-0537	A-42227-0537	36	42227-0555	A-42227-0555
19	42227-0538	A-42227-0538			

REV: <b>K5</b>	ECR/ECN INFORMATION: EC No.: <b>UCP2012-3374</b> DATE: <b>10/12/2012</b>	TITLE: <b>.100 FRICTION LOCK BREAKAWAY HEADER ASSY.</b>	SHEET No. <b>- 5 -</b>
DOCUMENT NUMBER: <b>SD- 42227 -002</b>	CREATED / REVISED BY: <b>MKIPPER</b>	CHECKED BY: <b>JBELL</b>	APPROVED BY: <b>FSMITH-ROEMER</b>



A-42227-0590/0617					
HEADER NUMBER:	41411				
PLATING:	154				
PIN LENGTH: L	.540/13.72				
MATING LENGTH: M	.295/7.49				
GOLD POINT: G	N/A				
PC TAIL LENGTH: P	.120/3.05				
TIN: T	OVERALL				
CKTS:	9-36				
KINKS:	YES, 1,7 ONLY SEE NOTE 7				
REMOVED BACKWALLS:	NO				
VOIDED CKTS:	2, 3, 5, 6, 8, 9				
PACKAGING:	BULK, PER PK-40873-0056				
CKTS	MATERIAL NUMBER	ENG NUMBER	CKTS	MATERIAL NUMBER	ENG NUMBER
02			20	22-29-0204	A-42227-0601
03			21	22-29-0214	A-42227-0602
04			22	22-29-0224	A-42227-0603
05			23	22-29-0234	A-42227-0604
06			24	22-29-0244	A-42227-0605
07			25	22-29-0254	A-42227-0606
08			26	22-29-0264	A-42227-0607
09	22-29-0094	A-42227-0590	27	22-29-0274	A-42227-0608
10	22-29-0104	A-42227-0591	28	22-29-0284	A-42227-0609
11	22-29-0114	A-42227-0592	29	22-29-0294	A-42227-0610
12	22-29-0124	A-42227-0593	30	22-29-0304	A-42227-0611
13	22-29-0134	A-42227-0594	31	22-29-0314	A-42227-0612
14	22-29-0144	A-42227-0595	32	22-29-0324	A-42227-0613
15	22-29-0154	A-42227-0596	33	22-29-0334	A-42227-0614
16	22-29-0164	A-42227-0597	34	22-29-0344	A-42227-0615
17	22-29-0174	A-42227-0598	35	22-29-0354	A-42227-0616
18	22-29-0184	A-42227-0599	36	22-29-0364	A-42227-0617
19	22-29-0194	A-42227-0600			

A-42227-0618/0647					
HEADER NUMBER:	41411				
PLATING:	228				
PIN LENGTH: L	.540/13.72				
MATING LENGTH: M	.295/7.49				
GOLD POINT: G	.180/4.57				
PC TAIL LENGTH: P	.120/3.05				
TIN: T	.135/3.43				
CKTS:	7-36				
KINKS:	NO				
REMOVED BACKWALLS:	NO				
VOIDED CKTS:	7				
PACKAGING:	BULK, PER PK-40873-0056				
CKTS	MATERIAL NUMBER	ENG NUMBER	CKTS	MATERIAL NUMBER	ENG NUMBER
02			20	42227-0631	A-42227-0631
03			21	42227-0632	A-42227-0632
04			22	42227-0633	A-42227-0633
05			23	42227-0634	A-42227-0634
06			24	42227-0635	A-42227-0635
07	42227-0618	A-42227-0618	25	42227-0636	A-42227-0636
08	42227-0619	A-42227-0619	26	42227-0637	A-42227-0637
09	42227-0620	A-42227-0620	27	42227-0638	A-42227-0638
10	42227-0621	A-42227-0621	28	42227-0639	A-42227-0639
11	42227-0622	A-42227-0622	29	42227-0640	A-42227-0640
12	42227-0623	A-42227-0623	30	42227-0641	A-42227-0641
13	42227-0624	A-42227-0624	31	42227-0642	A-42227-0642
14	42227-0625	A-42227-0625	32	42227-0643	A-42227-0643
15	42227-0626	A-42227-0626	33	42227-0644	A-42227-0644
16	42227-0627	A-42227-0627	34	42227-0645	A-42227-0645
17	42227-0628	A-42227-0628	35	42227-0646	A-42227-0646
18	42227-0629	A-42227-0629	36	42227-0647	A-42227-0647
19	42227-0630	A-42227-0630			

<b>REV:</b> <b>K5</b>	<u>ECR/ECN INFORMATION:</u>	<u>TITLE:</u> <b>.100 FRICTION LOCK BREAKAWAY HEADER ASSY.</b>	<u>SHEET No.</u> <b>- 6 -</b>
	EC No.: <b>UCP2012-3374</b> DATE: <b>10/12/2012</b>		
<u>DOCUMENT NUMBER:</u> <b>SD- 42227 -002</b>	<u>CREATED / REVISED BY:</u> <b>MKIPPER</b>	<u>CHECKED BY:</u> <b>JBELL</b>	<u>APPROVED BY:</u> <b>FSMITH-ROEMER</b>



A-42227-0648/0671					
HEADER NUMBER:	41411				
PLATING:	228				
PIN LENGTH: L	.540/13.72				
MATING LENGTH: M	.295/7.49				
GOLD POINT: G	.180/4.57				
PC TAIL LENGTH: P	.120/3.05				
TIN: T	.135/3.43				
CKTS:	13-36				
KINKS:	NO				
REMOVED BACKWALLS:	NO				
VOIDED CKTS:	13				
PACKAGING:	BULK, PER PK-40873-0056				
CKTS	MATERIAL NUMBER	ENG NUMBER	CKTS	MATERIAL NUMBER	ENG NUMBER
02			20	42227-0655	A-42227-0655
03			21	42227-0656	A-42227-0656
04			22	42227-0657	A-42227-0657
05			23	42227-0658	A-42227-0658
06			24	42227-0659	A-42227-0659
07			25	42227-0660	A-42227-0660
08			26	42227-0661	A-42227-0661
09			27	42227-0662	A-42227-0662
10			28	42227-0663	A-42227-0663
11			29	42227-0664	A-42227-0664
12			30	42227-0665	A-42227-0665
13	42227-0648	A-42227-0648	31	42227-0666	A-42227-0666
14	42227-0649	A-42227-0649	32	42227-0667	A-42227-0667
15	42227-0650	A-42227-0650	33	42227-0668	A-42227-0668
16	42227-0651	A-42227-0651	34	42227-0669	A-42227-0669
17	42227-0652	A-42227-0652	35	42227-0670	A-42227-0670
18	42227-0653	A-42227-0653	36	42227-0671	A-42227-0671
19	42227-0654	A-42227-0654			

A-42227-0672/0706					
HEADER NUMBER:	41411				
PLATING:	228				
PIN LENGTH: L	.540/13.72				
MATING LENGTH: M	.295/7.49				
GOLD POINT: G	.180/4.57				
PC TAIL LENGTH: P	.120/3.05				
TIN: T	.135/3.43				
CKTS:	2-36				
KINKS:	NO				
REMOVED BACKWALLS:	NO				
VOIDED CKTS:	2				
PACKAGING:	BULK, PER PK-40873-0056				
CKTS	MATERIAL NUMBER	ENG NUMBER	CKTS	MATERIAL NUMBER	ENG NUMBER
02	42227-0672	A-42227-0672	20	42227-0690	A-42227-0690
03	42227-0673	A-42227-0673	21	42227-0691	A-42227-0691
04	42227-0674	A-42227-0674	22	42227-0692	A-42227-0692
05	42227-0675	A-42227-0675	23	42227-0693	A-42227-0693
06	42227-0676	A-42227-0676	24	42227-0694	A-42227-0694
07	42227-0677	A-42227-0677	25	42227-0695	A-42227-0695
08	42227-0678	A-42227-0678	26	42227-0696	A-42227-0696
09	42227-0679	A-42227-0679	27	42227-0697	A-42227-0697
10	42227-0680	A-42227-0680	28	42227-0698	A-42227-0698
11	42227-0681	A-42227-0681	29	42227-0699	A-42227-0699
12	42227-0682	A-42227-0682	30	42227-0700	A-42227-0700
13	42227-0683	A-42227-0683	31	42227-0701	A-42227-0701
14	42227-0684	A-42227-0684	32	42227-0702	A-42227-0702
15	42227-0685	A-42227-0685	33	42227-0703	A-42227-0703
16	42227-0686	A-42227-0686	34	42227-0704	A-42227-0704
17	42227-0687	A-42227-0687	35	42227-0705	A-42227-0705
18	42227-0688	A-42227-0688	36	42227-0706	A-42227-0706
19	42227-0689	A-42227-0689			

<b>REV:</b> <b>K5</b>	<u>ECR/ECN INFORMATION:</u>	<u>TITLE:</u> <b>.100 FRICTION LOCK BREAKAWAY HEADER ASSY.</b>	<u>SHEET No.</u> <b>- 7 -</b>
	EC No.: <b>UCP2012-3374</b> DATE: <b>10/12/2012</b>		
<u>DOCUMENT NUMBER:</u> <b>SD- 42227 -002</b>	<u>CREATED / REVISED BY:</u> <b>MKIPPER</b>	<u>CHECKED BY:</u> <b>JBELL</b>	<u>APPROVED BY:</u> <b>FSMITH-ROEMER</b>



A-42227-0707/0741					
HEADER NUMBER:		41411			
PLATING:		154			
PIN LENGTH: L		.540/13.72			
MATING LENGTH: M		.280/7.11			
GOLD POINT: G		N/A			
PC TAIL LENGTH: P		.135/3.43			
TIN: T		OVERALL			
CKTS:		2-36			
KINKS:		NO			
REMOVED BACKWALLS:		NO			
VOIDED CKTS:		NONE			
PACKAGING:		BULK, PER PK-40873-0056			
CKTS	MATERIAL NUMBER	ENG NUMBER	CKTS	MATERIAL NUMBER	ENG NUMBER
02	42227-0707	A-42227-0707	20	42227-0725	A-42227-0725
03	42227-0708	A-42227-0708	21	42227-0726	A-42227-0726
04	42227-0709	A-42227-0709	22	42227-0727	A-42227-0727
05	42227-0710	A-42227-0710	23	42227-0728	A-42227-0728
06	42227-0711	A-42227-0711	24	42227-0729	A-42227-0729
07	42227-0712	A-42227-0712	25	42227-0730	A-42227-0730
08	42227-0713	A-42227-0713	26	42227-0731	A-42227-0731
09	42227-0714	A-42227-0714	27	42227-0732	A-42227-0732
10	42227-0714	A-42227-0715	28	42227-0733	A-42227-0733
11	42227-0716	A-42227-0716	29	42227-0734	A-42227-0734
12	42227-0717	A-42227-0717	30	42227-0735	A-42227-0735
13	42227-0718	A-42227-0718	31	42227-0736	A-42227-0736
14	42227-0719	A-42227-0719	32	42227-0737	A-42227-0737
15	42227-0720	A-42227-0720	33	42227-0738	A-42227-0738
16	42227-0721	A-42227-0721	34	42227-0739	A-42227-0739
17	42227-0722	A-42227-0722	35	42227-0740	A-42227-0740
18	42227-0723	A-42227-0723	36	42227-0741	A-42227-0741
19	42227-0724	A-42227-0724			

A-42227-0742/0775					
HEADER NUMBER:		41411			
PLATING:		154			
PIN LENGTH: L		.540/13.72			
MATING LENGTH: M		.280/7.11			
GOLD POINT: G		N/A			
PC TAIL LENGTH: P		.135/3.43			
TIN: T		OVERALL			
CKTS:		3-36			
KINKS:		NO			
REMOVED BACKWALLS:		NO			
VOIDED CKTS:		2			
PACKAGING:		BULK, PER PK-40873-0056			
CKTS	MATERIAL NUMBER	ENG NUMBER	CKTS	MATERIAL NUMBER	ENG NUMBER
02			20	42227-0759	A-42227-0759
03	42227-0742	A-42227-0742	21	42227-0760	A-42227-0760
04	42227-0743	A-42227-0743	22	42227-0761	A-42227-0761
05	42227-0744	A-42227-0744	23	42227-0762	A-42227-0762
06	42227-0745	A-42227-0745	24	42227-0763	A-42227-0763
07	42227-0746	A-42227-0746	25	42227-0764	A-42227-0764
08	42227-0747	A-42227-0747	26	42227-0765	A-42227-0765
09	42227-0748	A-42227-0748	27	42227-0766	A-42227-0766
10	42227-0749	A-42227-0749	28	42227-0767	A-42227-0767
11	42227-0750	A-42227-0750	29	42227-0768	A-42227-0768
12	42227-0751	A-42227-0751	30	42227-0769	A-42227-0769
13	42227-0752	A-42227-0752	31	42227-0770	A-42227-0770
14	42227-0753	A-42227-0753	32	42227-0771	A-42227-0771
15	42227-0754	A-42227-0754	33	42227-0772	A-42227-0772
16	42227-0755	A-42227-0755	34	42227-0773	A-42227-0773
17	42227-0756	A-42227-0756	35	42227-0774	A-42227-0774
18	42227-0757	A-42227-0757	36	42227-0775	A-42227-0775
19	42227-0758	A-42227-0758			

REV: <b>K5</b>	<u>ECR/ECN INFORMATION:</u>		<u>TITLE:</u>  <b>.100 FRICTION LOCK BREAKAWAY HEADER ASSY.</b>	<u>SHEET No.</u>  <b>- 8 -</b>
	EC No.:	<b>UCP2012-3374</b>		
	DATE:	<b>10/12/2012</b>		
<u>DOCUMENT NUMBER:</u> <b>SD- 42227 -002</b>		<u>CREATED / REVISED BY:</u> <b>MKIPPER</b>	<u>CHECKED BY:</u> <b>JBELL</b>	<u>APPROVED BY:</u> <b>FSMITH-ROEMER</b>





A-42227-0776/0792

HEADER NUMBER:	41411
PLATING:	154
PIN LENGTH: L	.540/13.72
MATING LENGTH: M	.280/7.11
GOLD POINT: G	N/A
PC TAIL LENGTH: P	.135/3.43
TIN: T	OVERALL
CKTS:	20-36
KINKS:	NO
REMOVED BACKWALLS:	NO
VOIDED CKTS:	20

PACKAGING: BULK, PER PK-40873-0056

CKTS	MATERIAL NUMBER	ENG NUMBER	CKTS	MATERIAL NUMBER	ENG NUMBER
02			20	42227-0776	A-42227-0776
03			21	42227-0777	A-42227-0777
04			22	42227-0778	A-42227-0778
05			23	42227-0779	A-42227-0779
06			24	42227-0780	A-42227-0780
07			25	42227-0781	A-42227-0781
08			26	42227-0782	A-42227-0782
09			27	42227-0783	A-42227-0783
10			28	42227-0784	A-42227-0784
11			29	42227-0785	A-42227-0785
12			30	42227-0786	A-42227-0786
13			31	42227-0787	A-42227-0787
14			32	42227-0788	A-42227-0788
15			33	42227-0789	A-42227-0789
16			34	42227-0790	A-42227-0790
17			35	42227-0791	A-42227-0791
18			36	42227-0792	A-42227-0792
19					

A-42227-0818/0848

HEADER NUMBER:	41411
PLATING:	154
PIN LENGTH: L	.540/13.72
MATING LENGTH: M	.295/7.49
GOLD POINT: G	N/A
PC TAIL LENGTH: P	.120/3.05
TIN: T	OVERALL
CKTS:	6-36
KINKS:	NO
REMOVED BACKWALLS:	NO
VOIDED CKTS:	3, 6

PACKAGING: BULK, PER PK-40873-0056

CKTS	MATERIAL NUMBER	ENG NUMBER	CKTS	MATERIAL NUMBER	ENG NUMBER
02			20	42227-0832	A-42227-0832
03			21	42227-0833	A-42227-0833
04			22	42227-0834	A-42227-0834
05			23	42227-0835	A-42227-0835
06	42227-0818	A-42227-0818	24	42227-0836	A-42227-0836
07	42227-0819	A-42227-0819	25	42227-0837	A-42227-0837
08	68352-0001	A-42227-0820	26	42227-0838	A-42227-0838
09	42227-0821	A-42227-0821	27	42227-0839	A-42227-0839
10	42227-0822	A-42227-0822	28	42227-0840	A-42227-0840
11	42227-0823	A-42227-0823	29	42227-0841	A-42227-0841
12	42227-0824	A-42227-0824	30	42227-0842	A-42227-0842
13	42227-0825	A-42227-0825	31	42227-0843	A-42227-0843
14	42227-0826	A-42227-0826	32	42227-0844	A-42227-0844
15	42227-0827	A-42227-0827	33	42227-0845	A-42227-0845
16	42227-0828	A-42227-0828	34	42227-0846	A-42227-0846
17	42227-0829	A-42227-0829	35	42227-0847	A-42227-0847
18	42227-0830	A-42227-0830	36	42227-0848	A-42227-0848
19	42227-0831	A-42227-0831			

REV: <b>K5</b>	<u>ECR/ECN INFORMATION:</u>	<u>TITLE:</u> <b>.100 FRICTION LOCK BREAKAWAY HEADER ASSY.</b>	<u>SHEET No.</u> <b>- 9 -</b>
	EC No.: <b>UCP2012-3374</b> DATE: <b>10/12/2012</b>		
<u>DOCUMENT NUMBER:</u> <b>SD- 42227 -002</b>	<u>CREATED / REVISED BY:</u> <b>MKIPPER</b>	<u>CHECKED BY:</u> <b>JBELL</b>	<u>APPROVED BY:</u> <b>FSMITH-ROEMER</b>



A-42227-0873/0900					
HEADER NUMBER:		41411			
PLATING:		154			
PIN LENGTH: L		.540/13.72			
MATING LENGTH: M		.295/7.49			
GOLD POINT: G		N/A			
PC TAIL LENGTH: P		.120/3.05			
TIN: T		OVERALL			
CKTS:		9-36			
KINKS:		NO			
REMOVED BACKWALLS:		YES			
VOIDED CKTS:		9			
PACKAGING:		BULK, PER PK-40873-0056			
CKTS	MATERIAL NUMBER	ENG NUMBER	CKTS	MATERIAL NUMBER	ENG NUMBER
02			20	42227-0884	A-42227-0884
03			21	42227-0885	A-42227-0885
04			22	42227-0886	A-42227-0886
05			23	42227-0887	A-42227-0887
06			24	42227-0888	A-42227-0888
07			25	42227-0889	A-42227-0889
08			26	42227-0890	A-42227-0890
09	42227-0873	A-42227-0873	27	42227-0891	A-42227-0891
10	42227-0874	A-42227-0874	28	42227-0892	A-42227-0892
11	42227-0875	A-42227-0875	29	42227-0893	A-42227-0893
12	42227-0876	A-42227-0876	30	42227-0894	A-42227-0894
13	42227-0877	A-42227-0877	31	42227-0895	A-42227-0895
14	42227-0878	A-42227-0878	32	42227-0896	A-42227-0896
15	42227-0879	A-42227-0879	33	42227-0897	A-42227-0897
16	42227-0880	A-42227-0880	34	42227-0898	A-42227-0898
17	42227-0881	A-42227-0881	35	42227-0899	A-42227-0899
18	42227-0882	A-42227-0882	36	42227-0900	A-42227-0900
19	42227-0883	A-42227-0883			

A-42227-0934/0967					
HEADER NUMBER:		41411			
PLATING:		154			
PIN LENGTH: L		.540/13.72			
MATING LENGTH: M		.280/7.11			
GOLD POINT: G		N/A			
PC TAIL LENGTH: P		.135/3.43			
TIN: T		OVERALL			
CKTS:		3-36			
KINKS:		NO			
REMOVED BACKWALLS:		YES			
VOIDED CKTS:		NONE			
PACKAGING:		BULK, PER PK-40873-0056			
CKTS	MATERIAL NUMBER	ENG NUMBER	CKTS	MATERIAL NUMBER	ENG NUMBER
02			20	42227-0951	A-42227-0951
03	42227-0934	A-42227-0934	21	42227-0952	A-42227-0952
04	42227-0935	A-42227-0935	22	42227-0953	A-42227-0953
05	42227-0936	A-42227-0936	23	42227-0954	A-42227-0954
06	42227-0937	A-42227-0937	24	42227-0955	A-42227-0955
07	42227-0938	A-42227-0938	25	42227-0956	A-42227-0956
08	42227-0939	A-42227-0939	26	42227-0957	A-42227-0957
09	42227-0940	A-42227-0940	27	42227-0958	A-42227-0958
10	42227-0941	A-42227-0941	28	42227-0959	A-42227-0959
11	42227-0942	A-42227-0942	29	42227-0960	A-42227-0960
12	42227-0943	A-42227-0943	30	42227-0961	A-42227-0961
13	42227-0944	A-42227-0944	31	42227-0962	A-42227-0962
14	42227-0945	A-42227-0945	32	42227-0963	A-42227-0963
15	42227-0946	A-42227-0946	33	42227-0964	A-42227-0964
16	42227-0947	A-42227-0947	34	42227-0965	A-42227-0965
17	42227-0948	A-42227-0948	35	42227-0966	A-42227-0966
18	42227-0949	A-42227-0949	36	42227-0967	A-42227-0967
19	42227-0950	A-42227-0950			

REV: <b>K5</b>	<u>ECR/ECN INFORMATION:</u>		<u>TITLE:</u> <b>.100 FRICTION LOCK BREAKAWAY HEADER ASSY.</b>	<u>SHEET No.</u> <b>- 10 -</b>
	EC No.:	<b>UCP2012-3374</b>		
	DATE:	<b>10/12/2012</b>		
<u>DOCUMENT NUMBER:</u> <b>SD- 42227 -002</b>		<u>CREATED / REVISED BY:</u> <b>MKIPPER</b>	<u>CHECKED BY:</u> <b>JBELL</b>	<u>APPROVED BY:</u> <b>FSMITH-ROEMER</b>



A-42227-0968/1001					
HEADER NUMBER:		41411			
PLATING:		154			
PIN LENGTH: L		.670/17.02			
MATING LENGTH: M		.295/7.49			
GOLD POINT: G		N/A			
PC TAIL LENGTH: P		.250/6.35			
TIN: T		OVERALL			
CKTS:		3-36			
KINKS:		NO			
REMOVED BACKWALLS:		YES			
VOIDED CKTS:		NONE			
PACKAGING:		BULK, PER PK-40873-0056			
CKTS	MATERIAL NUMBER	ENG NUMBER	CKTS	MATERIAL NUMBER	ENG NUMBER
02			20	42227-0985	A-42227-0985
03	42227-0968	A-42227-0968	21	42227-0986	A-42227-0986
04	42227-0969	A-42227-0969	22	42227-0987	A-42227-0987
05	42227-0970	A-42227-0970	23	42227-0988	A-42227-0988
06	42227-0971	A-42227-0971	24	42227-0989	A-42227-0989
07	42227-0972	A-42227-0972	25	42227-0990	A-42227-0990
08	42227-0973	A-42227-0973	26	42227-0991	A-42227-0991
09	42227-0974	A-42227-0974	27	42227-0992	A-42227-0992
10	42227-0975	A-42227-0975	28	42227-0993	A-42227-0993
11	42227-0976	A-42227-0976	29	42227-0994	A-42227-0994
12	42227-0977	A-42227-0977	30	42227-0995	A-42227-0995
13	42227-0978	A-42227-0978	31	42227-0996	A-42227-0996
14	42227-0979	A-42227-0979	32	42227-0997	A-42227-0997
15	42227-0980	A-42227-0980	33	42227-0998	A-42227-0998
16	42227-0981	A-42227-0981	34	42227-0999	A-42227-0999
17	42227-0982	A-42227-0982	35	42227-1000	A-42227-1000
18	42227-0983	A-42227-0983	36	42227-1001	A-42227-1001
19	42227-0984	A-42227-0984			

A-42227-1002/1036					
HEADER NUMBER:		41411			
PLATING:		228			
PIN LENGTH: L		.600/15.24			
MATING LENGTH: M		.295/7.49			
GOLD POINT: G		.180/4.57			
PC TAIL LENGTH: P		.180/4.57			
TIN: T		.135/3.43			
CKTS:		2-36			
KINKS:		NO			
REMOVED BACKWALLS:		NO			
VOIDED CKTS:		NONE			
PACKAGING:		BULK, PER PK-40873-0056			
CKTS	MATERIAL NUMBER	ENG NUMBER	CKTS	MATERIAL NUMBER	ENG NUMBER
02	42227-1002	A-42227-1002	20	42227-1020	A-42227-1020
03	42227-1003	A-42227-1003	21	42227-1021	A-42227-1021
04	42227-1004	A-42227-1004	22	42227-1022	A-42227-1022
05	42227-1005	A-42227-1005	23	42227-1023	A-42227-1023
06	42227-1006	A-42227-1006	24	42227-1024	A-42227-1024
07	42227-1007	A-42227-1007	25	42227-1025	A-42227-1025
08	42227-1008	A-42227-1008	26	42227-1026	A-42227-1026
09	42227-1009	A-42227-1009	27	42227-1027	A-42227-1027
10	42227-1010	A-42227-1010	28	42227-1028	A-42227-1028
11	42227-1011	A-42227-1011	29	42227-1029	A-42227-1029
12	42227-1012	A-42227-1012	30	42227-1030	A-42227-1030
13	42227-1013	A-42227-1013	31	42227-1031	A-42227-1031
14	42227-1014	A-42227-1014	32	42227-1032	A-42227-1032
15	42227-1015	A-42227-1015	33	42227-1033	A-42227-1033
16	42227-1016	A-42227-1016	34	42227-1034	A-42227-1034
17	42227-1017	A-42227-1017	35	42227-1035	A-42227-1035
18	42227-1018	A-42227-1018	36	42227-1036	A-42227-1036
19	42227-1019	A-42227-1019			

REV: <b>K5</b>	<u>ECR/ECN INFORMATION:</u>		<u>TITLE:</u> <b>.100 FRICTION LOCK BREAKAWAY HEADER ASSY.</b>	<u>SHEET No.</u> <b>- 11 -</b>
	EC No.:	<b>UCP2012-3374</b>		
	DATE:	<b>10/12/2012</b>		
<u>DOCUMENT NUMBER:</u> <b>SD- 42227 -002</b>		<u>CREATED / REVISED BY:</u> <b>MKIPPER</b>	<u>CHECKED BY:</u> <b>JBELL</b>	<u>APPROVED BY:</u> <b>FSMITH-ROEMER</b>



A-42227-1037/1071					
HEADER NUMBER:		41411			
PLATING:		228			
PIN LENGTH: L		.600/15.24			
MATING LENGTH: M		.295/7.49			
GOLD POINT: G		.180/4.57			
PC TAIL LENGTH: P		.180/4.57			
TIN: T		.135/3.43			
CKTS:		2-36			
KINKS:		NO			
REMOVED BACKWALLS:		YES			
VOIDED CKTS:		NONE			
PACKAGING:		BULK, PER PK-40873-0056			
CKTS	MATERIAL NUMBER	ENG NUMBER	CKTS	MATERIAL NUMBER	ENG NUMBER
02	42227-1037	A-42227-1037	20	42227-1055	A-42227-1055
03	42227-1038	A-42227-1038	21	42227-1056	A-42227-1056
04	42227-1039	A-42227-1039	22	42227-1057	A-42227-1057
05	42227-1040	A-42227-1040	23	42227-1058	A-42227-1058
06	42227-1041	A-42227-1041	24	42227-1059	A-42227-1059
07	42227-1042	A-42227-1042	25	42227-1060	A-42227-1060
08	42227-1043	A-42227-1043	26	42227-1061	A-42227-1061
09	42227-1044	A-42227-1044	27	42227-1062	A-42227-1062
10	42227-1045	A-42227-1045	28	42227-1063	A-42227-1063
11	42227-1046	A-42227-1046	29	42227-1064	A-42227-1064
12	42227-1047	A-42227-1047	30	42227-1065	A-42227-1065
13	42227-1048	A-42227-1048	31	42227-1066	A-42227-1066
14	42227-1049	A-42227-1049	32	42227-1067	A-42227-1067
15	42227-1050	A-42227-1050	33	42227-1068	A-42227-1068
16	42227-1051	A-42227-1051	34	42227-1069	A-42227-1069
17	42227-1052	A-42227-1052	35	42227-1070	A-42227-1070
18	42227-1053	A-42227-1053	36	42227-1071	A-42227-1071
19	42227-1054	A-42227-1054			

A-42227-1072/1106					
HEADER NUMBER:		41411			
PLATING:		208			
PIN LENGTH: L		.540 / 13.72			
MATING LENGTH: M		.280 / 7.11			
GOLD POINT: G		.140 / 3.56			
PC TAIL LENGTH: P		.135 / 3.43			
TIN: T		.135 / 3.43			
CKTS:		3-36			
KINKS:		NO			
REMOVED BACKWALLS:		YES			
VOIDED CKTS:		3			
PACKAGING:		BULK, PER PK-40873-0056			
CKTS	MATERIAL NUMBER	ENG NUMBER	CKTS	MATERIAL NUMBER	ENG NUMBER
02			20		
03			21		
04			22		
05			23		
06			24		
07			25		
08			26		
09			27		
10			28		
11			29		
12			30		
13			31		
14			32		
15			33		
16			34		
17			35		
18	42227-1088	A-42227-1088	36		
19					

REV: <b>K5</b>	<u>ECR/ECN INFORMATION:</u>		<u>TITLE:</u> <b>.100 FRICTION LOCK BREAKAWAY HEADER ASSY.</b>	<u>SHEET No.</u> <b>- 12 -</b>
	EC No.:	<b>UCP2012-3374</b>		
	DATE:	<b>10/12/2012</b>		
<u>DOCUMENT NUMBER:</u> <b>SD- 42227 -002</b>		<u>CREATED / REVISED BY:</u> <b>MKIPPER</b>	<u>CHECKED BY:</u> <b>JBELL</b>	<u>APPROVED BY:</u> <b>FSMITH-ROEMER</b>