

XUM8APCNM8

Photoelectric sensors XU, XUM, BGS, Sn 0.3 m, 12...24 VDC, M8



Main

Range of Product	Telemecanique Photoelectric sensors XU
Series name	General purpose single mode
Electronic sensor type	Photo-electric sensor
Sensor name	XUM
Sensor design	Miniature
Detection system	Diffuse with background suppression
Material	Plastic
Type of output signal	Discrete
Supply circuit type	DC
Wiring Technique	3-wire
Discrete output type	PNP
Discrete output function	1 NO or 1 NC programmable
Electrical connection	1 male connector M8, 4 pins
Product Specific Application	-
Emission	Red diffuse with background suppression
[Sn] nominal sensing distance	0.98 ft (0.3 m) diffuse with background suppression

Complementary

Enclosure Material	PBT
Lens material	PC
Maximum sensing distance	0.98 ft (0.3 m) diffuse with background suppression
Output Type	Solid state
Wire insulation material	PVC
Status LED	1 LED yellow)output state 1 LED red)instability
[Us] rated supply voltage	12...24 V DC
Supply voltage limits	10...30 V DC
Switching capacity in mA	<= 100 mA (overload and short-circuit protection)
Switching frequency	<= 500 Hz
Maximum voltage drop	<1.5 V (closed state)
Current consumption	35 mA (no-load)
Maximum delay first up	30 ms
Maximum delay response	1 ms
Maximum delay recovery	1 ms
Setting-up	Without sensitivity adjustment
Depth	1.06 in (27 mm)
Height	1.50 in (38 mm)
Length	0.43 in (11 mm)
Width	0.47 in (12 mm)
Net Weight	0.04 lb(US) (0.02 kg)

Environment

Product Certifications	CE UL CSA
Ambient air temperature for operation	-13...131 °F (-25...55 °C)
Ambient Air Temperature for Storage	-22...158 °F (-30...70 °C)
Immunity to ambient light	3000 Lux natural light 3000 lux incandescent light
Vibration resistance	7 gn +/- 1.5 mm 10...55 Hz) IEC 60068-2-6
Shock resistance	30 gn 11 ms) IEC 60068-2-27
IP degree of protection	IP67 double insulation IEC 60529 IP65 double insulation IEC 60529



Ordering and shipping details

Category	22415 - SENSORS, PHOTOELECTRIC, BASIC
Discount Schedule	DS2
GTIN	3389119060974
Nbr. of units in pkg.	1
Package weight(Lbs)	0.49 oz (14 g)
Returnability	Yes
Country of origin	JP

Packing Units

Unit Type of Package 1	PCE
Package 1 Height	0.59 in (1.5 cm)
Package 1 width	6.30 in (16 cm)
Package 1 Length	7.87 in (20 cm)
Unit Type of Package 2	S01
Number of Units in Package 2	48
Package 2 Weight	33.37 oz (946 g)
Package 2 Height	5.91 in (15 cm)
Package 2 width	5.91 in (15 cm)
Package 2 Length	15.75 in (40 cm)

Offer Sustainability

California proposition 65	WARNING: This product can expose you to chemicals including: Diisononyl phthalate (DINP), which is known to the State of California to cause cancer, and Di-isodecyl phthalate (DIDP), which is known to the State of California to cause birth defects or other reproductive harm. For more information go to www.P65Warnings.ca.gov
EU RoHS Directive	Pro-active compliance (Product out of EU RoHS legal scope)  EU RoHS Declaration
Mercury free	Yes
RoHS exemption information	 Yes

Contractual warranty

Warranty	18 months
----------	-----------

Dimensions

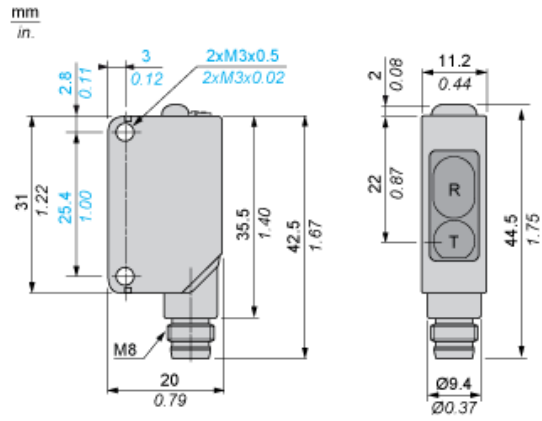

R : Reception
T : Transmission

Mounting

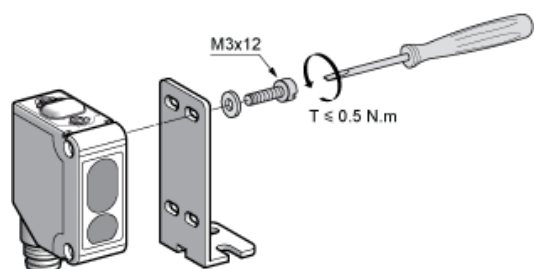

Wiring Schemes

M8 Connector

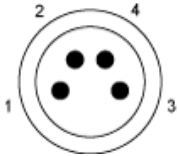

- 1 : (+)
- 2 : Mode/Input
- 3 : (-)
- 4 : Output

PNP Output

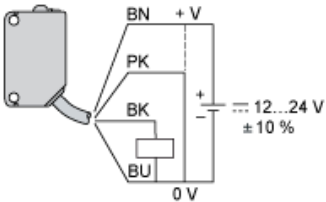

- BU : Blue
- BN : Brown
- BK : Black
- PK : Pink

Note :This scheme is represented in "background suppression" mode, cabling of pink (PK) wire to 0 V

Detection Curves

Variation of Usable Sensing Distance

Minimum Setting

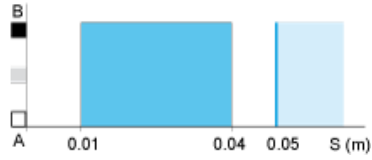

Maximum Setting

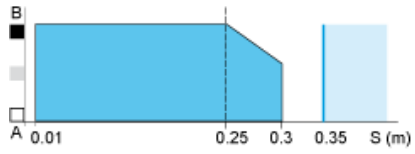

- (1) Black 6%
- (2) Grey 18%
- (3) White 90%
- (4) Sensing range
- (5) Non sensing zone (matt surfaces)

A-B : Object reflection coefficient

- (1) Black 6%
- (2) Grey 18%
- (3) White 90%
- (4) Sensing range
- (5) Non sensing zone (matt surfaces)