



PSMN039-100YS

N-channel LFPAK 100 V 39.5 m Ω standard level MOSFET

Rev. 02 — 2 April 2010

Product data sheet

1. Product profile

1.1 General description

Standard level N-channel MOSFET in LFPAK package qualified to 175 °C. This product is designed and qualified for use in a wide range of industrial, communications and domestic equipment.

1.2 Features and benefits

- Advanced TrenchMOS provides low RDSon and low gate charge
- High efficiency gains in switching power converters
- Improved mechanical and thermal characteristics
- LFPAK provides maximum power density in a Power SO8 package

1.3 Applications

- DC-to-DC converters
- Lithium-ion battery protection
- Load switching
- Motor control
- Server power supplies

1.4 Quick reference data

Table 1. Quick reference

Symbol	Parameter	Conditions	Min	Typ	Max	Unit
V _{DS}	drain-source voltage	T _j ≥ 25 °C; T _j ≤ 175 °C	-	-	100	V
I _D	drain current	T _{mb} = 25 °C; V _{GS} = 10 V; see Figure 1	-	-	28.1	A
P _{tot}	total power dissipation	T _{mb} = 25 °C; see Figure 2	-	-	74	W
T _j	junction temperature		-55	-	175	°C
Avalanche ruggedness						
E _{DS(AL)S}	non-repetitive drain-source avalanche energy	V _{GS} = 10 V; T _{j(init)} = 25 °C; I _D = 28.1 A; V _{sup} ≤ 100 V; unclamped; R _{GS} = 50 Ω	-	-	42	mJ
Dynamic characteristics						
Q _{GD}	gate-drain charge	V _{GS} = 10 V; I _D = 15 A;	-	8	-	nC
Q _{G(tot)}	total gate charge	V _{DS} = 50 V; see Figure 14 and 15	-	23	-	nC

Table 1. Quick reference ...continued

Symbol	Parameter	Conditions	Min	Typ	Max	Unit
Static characteristics						
$R_{DS(on)}$	drain-source on-state resistance	$V_{GS} = 10\text{ V}; I_D = 15\text{ A};$ $T_j = 100\text{ °C};$ see Figure 12	-	-	71	mΩ
		$V_{GS} = 10\text{ V}; I_D = 15\text{ A};$ $T_j = 25\text{ °C};$ see Figure 13	-	30.8	39.5	mΩ

2. Pinning information

Table 2. Pinning information

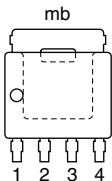
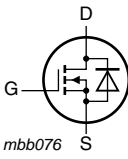
Pin	Symbol	Description	Simplified outline	Graphic symbol
1	S	source		
2	S	source		
3	S	source		
4	G	gate		
mb	D	mounting base; connected to drain		

SOT669 (LPAK)

3. Ordering information

Table 3. Ordering information

Type number	Package		Version
	Name	Description	
PSMN039-100YS	LPAK	plastic single-ended surface-mounted package (LPAK); 4 leads	SOT669

4. Limiting values

Table 4. Limiting values

In accordance with the Absolute Maximum Rating System (IEC 60134).

Symbol	Parameter	Conditions	Min	Max	Unit
V _{DS}	drain-source voltage	T _j ≥ 25 °C; T _j ≤ 175 °C	-	100	V
V _{DGR}	drain-gate voltage	T _j ≤ 175 °C; T _j ≥ 25 °C; R _{GS} = 20 kΩ	-	100	V
V _{GS}	gate-source voltage		-20	20	V
I _D	drain current	V _{GS} = 10 V; T _{mb} = 100 °C; see Figure 1	-	20	A
		V _{GS} = 10 V; T _{mb} = 25 °C; see Figure 1	-	28.1	A
I _{DM}	peak drain current	t _p ≤ 10 μs; pulsed; T _{mb} = 25 °C; see Figure 3	-	112	A
P _{tot}	total power dissipation	T _{mb} = 25 °C; see Figure 2	-	74	W
T _{stg}	storage temperature		-55	175	°C
T _j	junction temperature		-55	175	°C
T _{slid(M)}	peak soldering temperature		-	260	°C
Source-drain diode					
I _S	source current	T _{mb} = 25 °C	-	28.1	A
I _{SM}	peak source current	t _p ≤ 10 μs; pulsed; T _{mb} = 25 °C	-	112	A
Avalanche ruggedness					
E _{DS(AL)S}	non-repetitive drain-source avalanche energy	V _{GS} = 10 V; T _{j(init)} = 25 °C; I _D = 28.1 A; V _{sup} ≤ 100 V; unclamped; R _{GS} = 50 Ω	-	42	mJ

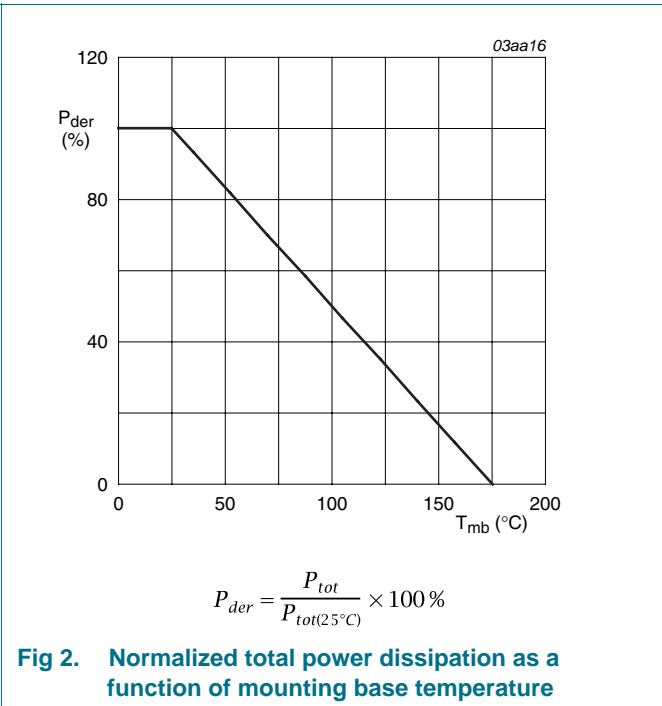
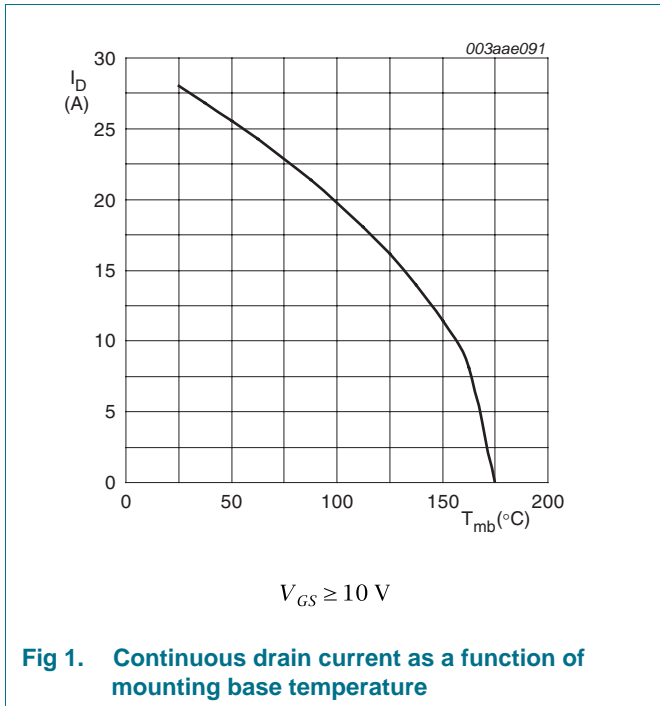

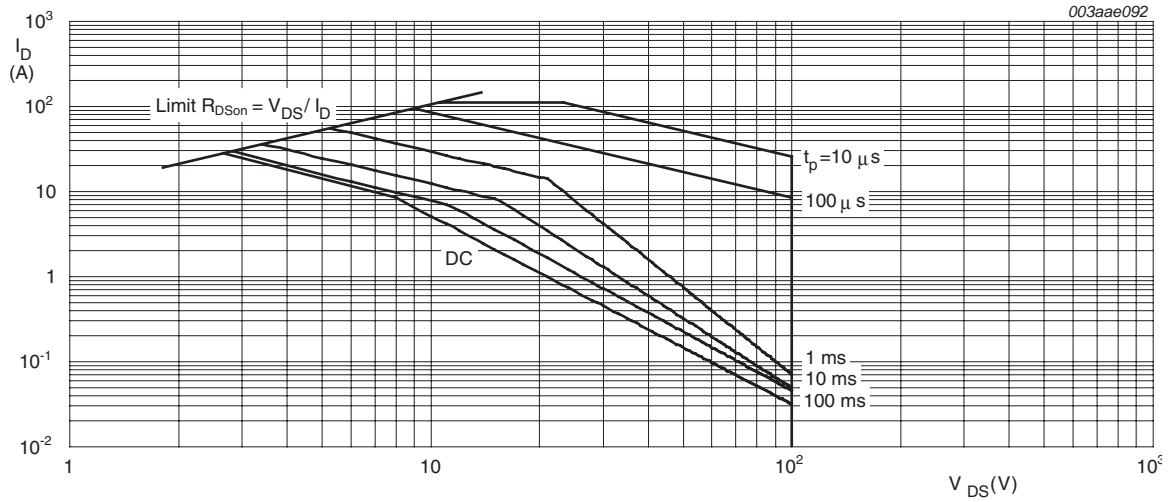

$T_{mb} = 25\text{ }^{\circ}\text{C}; I_{DM}$ is single pulse

Fig 3. Safe operating area; continuous and peak drain currents as a function of drain-source voltage

5. Thermal characteristics

Table 5. Thermal characteristics

Symbol	Parameter	Conditions	Min	Typ	Max	Unit
$R_{th(j-mb)}$	thermal resistance from junction to mounting base	see Figure 4	-	1	2.03	K/W

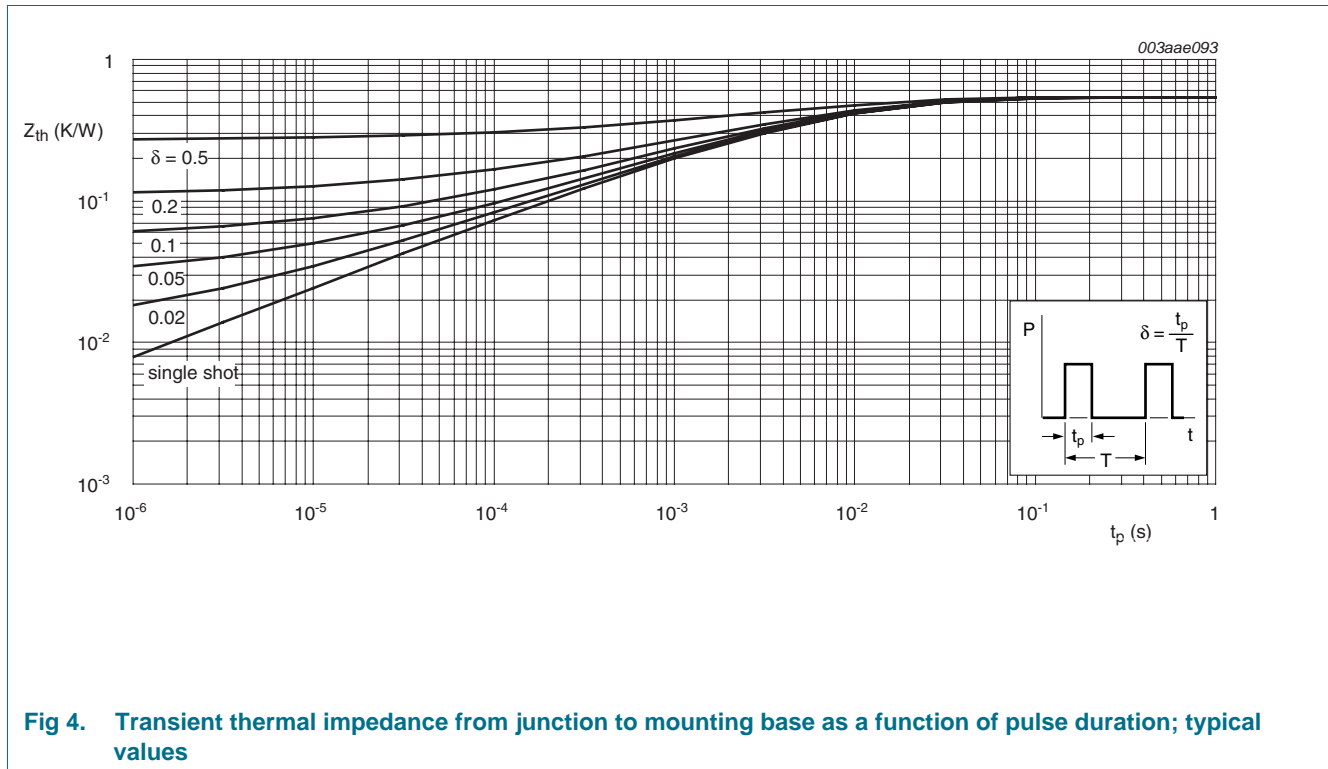

Fig 4. Transient thermal impedance from junction to mounting base as a function of pulse duration; typical values

6. Characteristics

Table 6. Characteristics

Symbol	Parameter	Conditions	Min	Typ	Max	Unit
Static characteristics						
$V_{(BR)DSS}$	drain-source breakdown voltage	$I_D = 0.25 \text{ mA}; V_{GS} = 0 \text{ V}; T_j = -55 \text{ }^\circ\text{C}$	90	-	-	V
		$I_D = 0.25 \text{ mA}; V_{GS} = 0 \text{ V}; T_j = 25 \text{ }^\circ\text{C}$	100	-	-	V
$V_{GS(th)}$	gate-source threshold voltage	$I_D = 1 \text{ mA}; V_{DS} = V_{GS}; T_j = 175 \text{ }^\circ\text{C};$ see Figure 10	1	-	-	V
		$I_D = 1 \text{ mA}; V_{DS} = V_{GS}; T_j = 25 \text{ }^\circ\text{C};$ see Figure 11 and 10	2	3	4	V
		$I_D = 1 \text{ mA}; V_{DS} = V_{GS}; T_j = -55 \text{ }^\circ\text{C};$ see Figure 10	-	-	4.7	V
I_{DSS}	drain leakage current	$V_{DS} = 100 \text{ V}; V_{GS} = 0 \text{ V}; T_j = 125 \text{ }^\circ\text{C}$	-	-	50	μA
		$V_{DS} = 100 \text{ V}; V_{GS} = 0 \text{ V}; T_j = 25 \text{ }^\circ\text{C}$	-	0.01	2	μA
I_{GSS}	gate leakage current	$V_{GS} = 20 \text{ V}; V_{DS} = 0 \text{ V}; T_j = 25 \text{ }^\circ\text{C}$	-	2	100	nA
		$V_{GS} = -20 \text{ V}; V_{DS} = 0 \text{ V}; T_j = 25 \text{ }^\circ\text{C}$	-	2	100	nA
$R_{DS(on)}$	drain-source on-state resistance	$V_{GS} = 10 \text{ V}; I_D = 15 \text{ A}; T_j = 100 \text{ }^\circ\text{C};$ see Figure 12	-	-	71	mΩ
		$V_{GS} = 10 \text{ V}; I_D = 15 \text{ A}; T_j = 175 \text{ }^\circ\text{C};$ see Figure 12	-	72.9	100	mΩ
		$V_{GS} = 10 \text{ V}; I_D = 15 \text{ A}; T_j = 25 \text{ }^\circ\text{C};$ see Figure 13	-	30.8	39.5	mΩ
R_G	internal gate resistance (AC)	$f = 1 \text{ MHz}$	-	0.62	1.5	Ω
Dynamic characteristics						
$Q_{G(tot)}$	total gate charge	$I_D = 15 \text{ A}; V_{DS} = 50 \text{ V}; V_{GS} = 10 \text{ V};$ see Figure 14 and 15	-	23	-	nC
		$I_D = 0 \text{ A}; V_{DS} = 0 \text{ V}; V_{GS} = 10 \text{ V}$	-	19	-	nC
Q_{GS}	gate-source charge	$I_D = 15 \text{ A}; V_{DS} = 50 \text{ V}; V_{GS} = 10 \text{ V};$ see Figure 14	-	5	-	nC
$Q_{GS(th)}$	pre-threshold gate-source charge		-	3	-	nC
$Q_{GS(th-pl)}$	post-threshold gate-source charge		-	2	-	nC
Q_{GD}	gate-drain charge	$I_D = 15 \text{ A}; V_{DS} = 50 \text{ V}; V_{GS} = 10 \text{ V};$ see Figure 14 and 15	-	8	-	nC
$V_{GS(pl)}$	gate-source plateau voltage	$V_{DS} = 50 \text{ V};$ see Figure 14 and 15	-	4.5	-	V
C_{iss}	input capacitance	$V_{DS} = 50 \text{ V}; V_{GS} = 0 \text{ V}; f = 1 \text{ MHz};$ $T_j = 25 \text{ }^\circ\text{C};$ see Figure 16	-	1847	-	pF
C_{oss}	output capacitance		-	86	-	pF
C_{rss}	reverse transfer capacitance		-	64	-	pF
$t_{d(on)}$	turn-on delay time	$V_{DS} = 50 \text{ V}; R_L = 3.3 \text{ }^\circ\Omega; V_{GS} = 10 \text{ V};$ $R_{G(ext)} = 4.7 \text{ }^\circ\Omega; T_j = 25 \text{ }^\circ\text{C}$	-	11	-	ns
t_r	rise time		-	8	-	ns
$t_{d(off)}$	turn-off delay time		-	22	-	ns
t_f	fall time		-	7	-	ns

Table 6. Characteristics ...continued

Symbol	Parameter	Conditions	Min	Typ	Max	Unit
Source-drain diode						
V_{SD}	source-drain voltage	$I_S = 15\text{ A}$; $V_{GS} = 0\text{ V}$; $T_j = 25\text{ °C}$; see Figure 17	-	0.8	1.2	V
t_{rr}	reverse recovery time	$I_S = 5\text{ A}$; $di_S/dt = 100\text{ A}/\mu\text{s}$; $V_{GS} = 0\text{ V}$;	-	44	-	ns
Q_r	recovered charge	$V_{DS} = 50\text{ V}$	-	78	-	nC

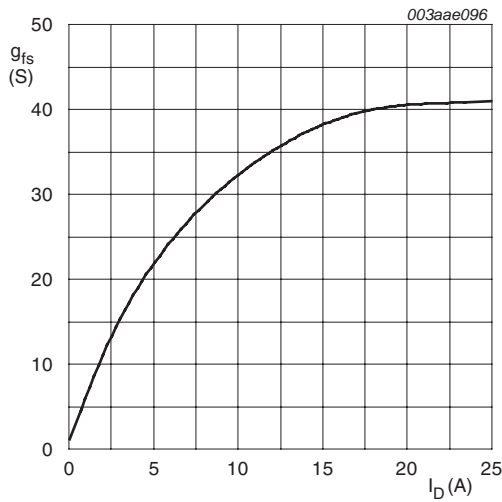

$T_j = 25\text{ °C}$; $V_{DS} = 10\text{ V}$

Fig 5. Forward transconductance as a function of drain current; typical values

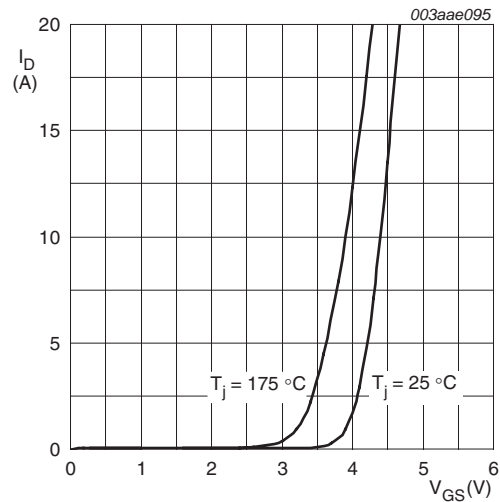

$V_{DS} > I_D \times R_{DSon}$

Fig 6. Transfer characteristics: drain current as a function of gate-source voltage; typical values

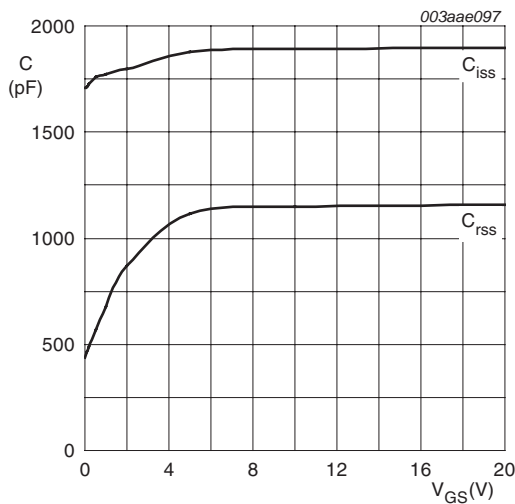

$V_{GS} = 0\text{ V}$; $f = 1\text{ MHz}$

Fig 7. Input, output and reverse transfer capacitances as a function of drain-source voltage; typical values

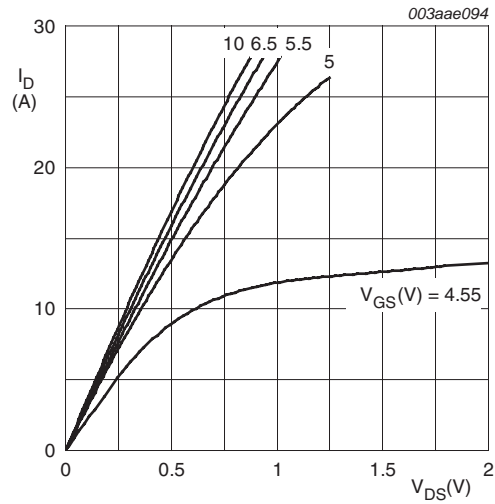

$T_j = 25\text{ °C}$

Fig 8. Output characteristics: drain current as a function of drain-source voltage; typical values

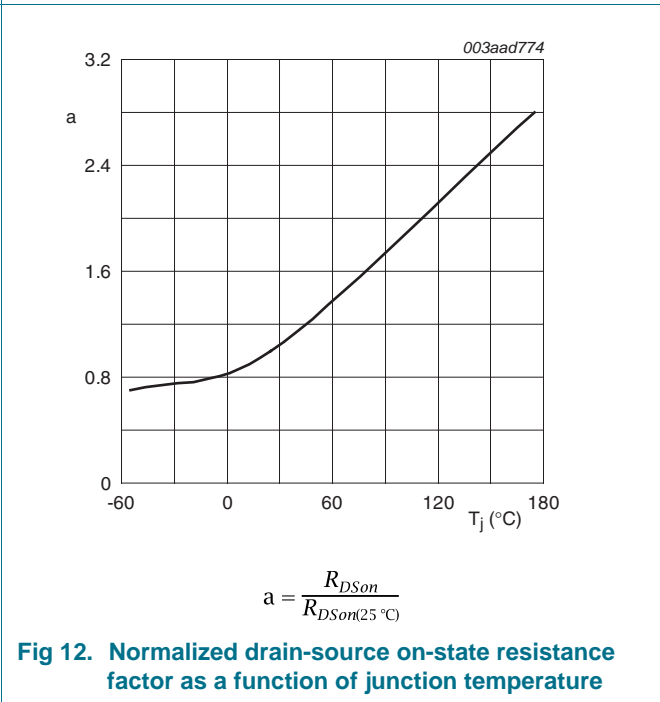
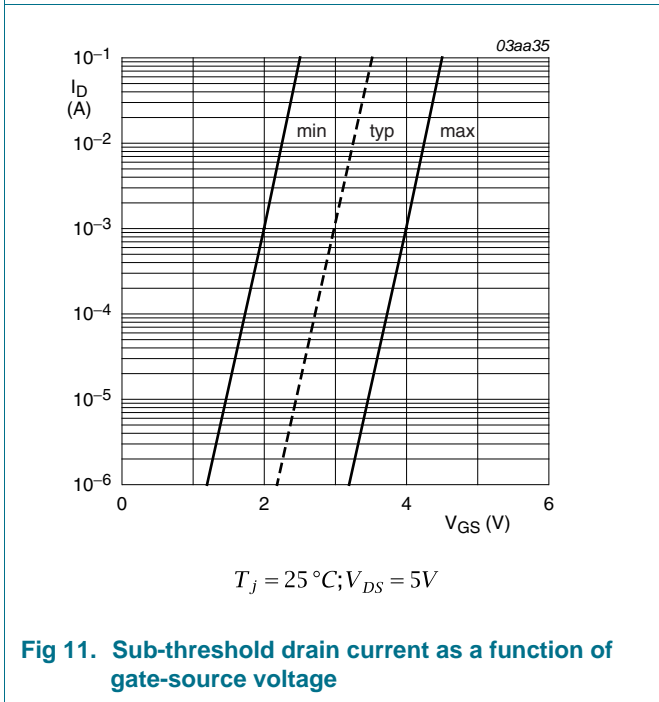
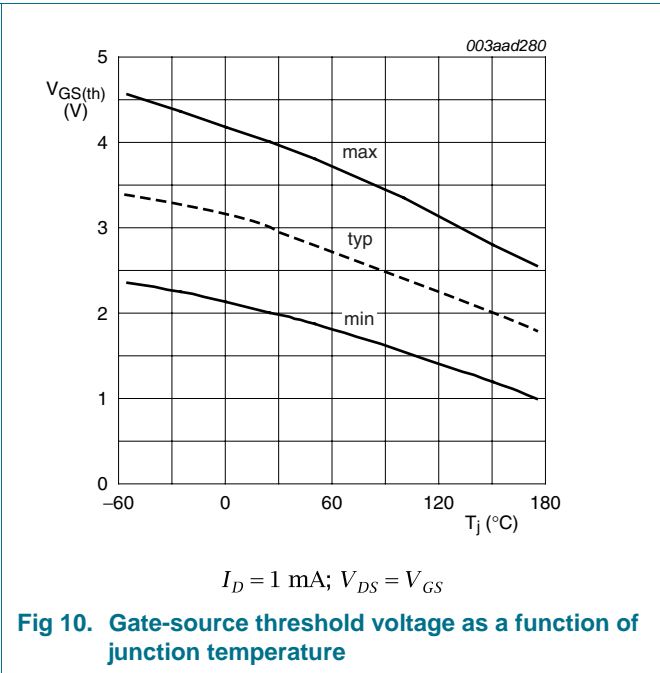
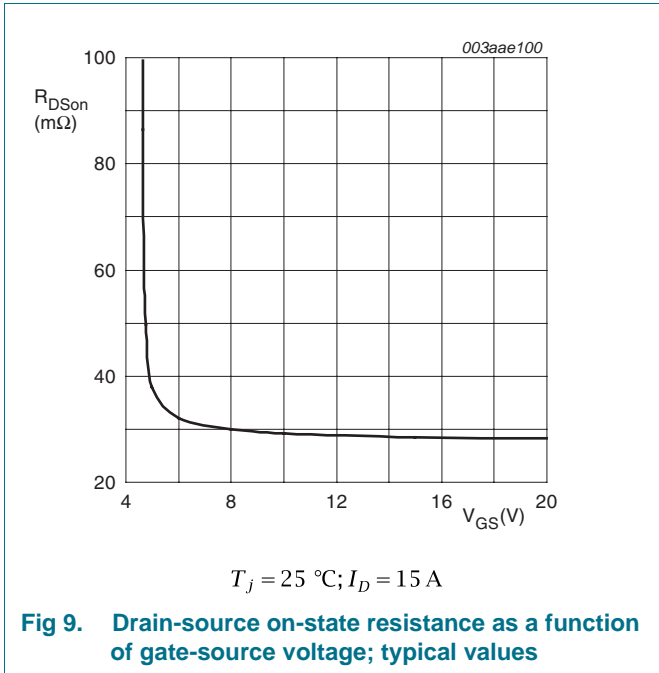

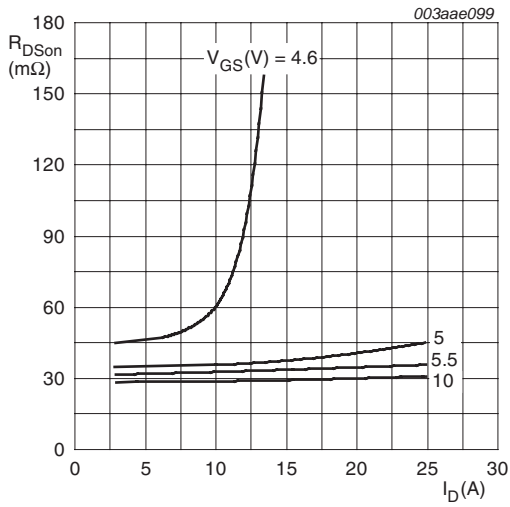

$T_j = 25\text{ }^\circ\text{C}$

Fig 13. Drain-source on-state resistance as a function of drain current; typical values

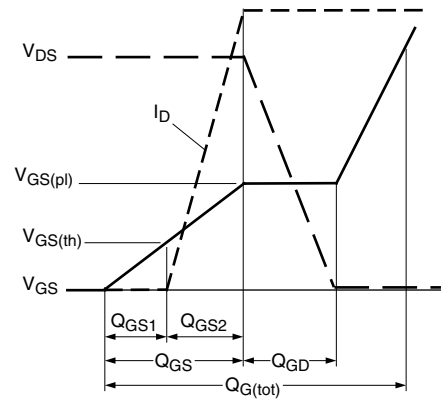

003aaa508

Fig 14. Gate charge waveform definitions

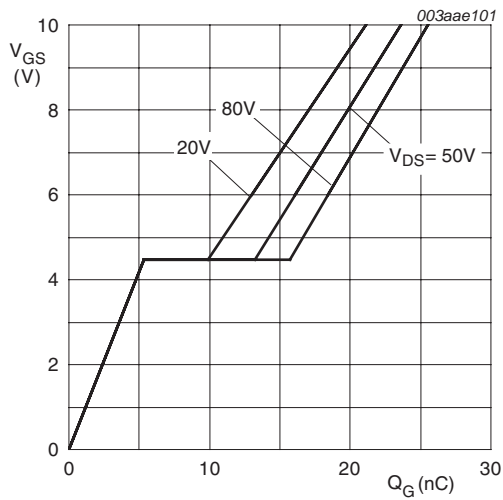

$T_j = 25\text{ }^\circ\text{C}; I_D = 15\text{ A}$

Fig 15. Gate-source voltage as a function of gate charge; typical values

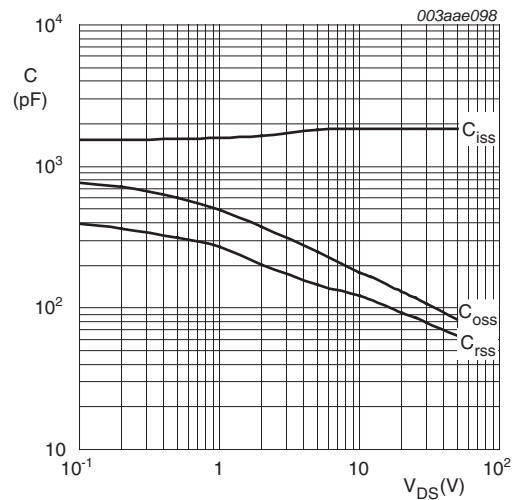

$T_j = 25\text{ }^\circ\text{C}$

Fig 16. Drain-source on-state resistance as a function of drain current; typical values

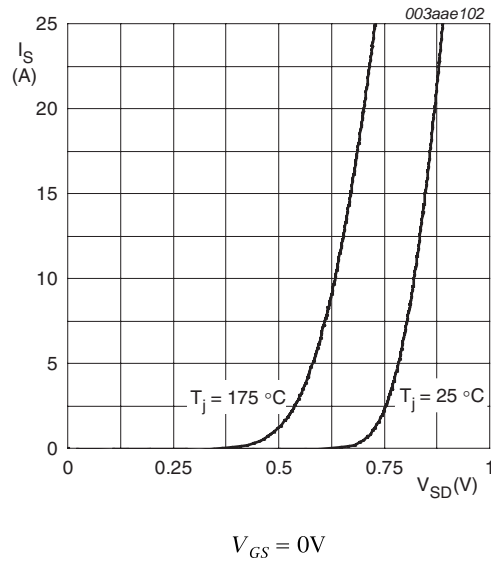

Fig 17. Source (diode forward) current as a function of source-drain (diode forward) voltage; typical values

7. Package outline

Plastic single-ended surface-mounted package (LPAK); 4 leads

SOT669

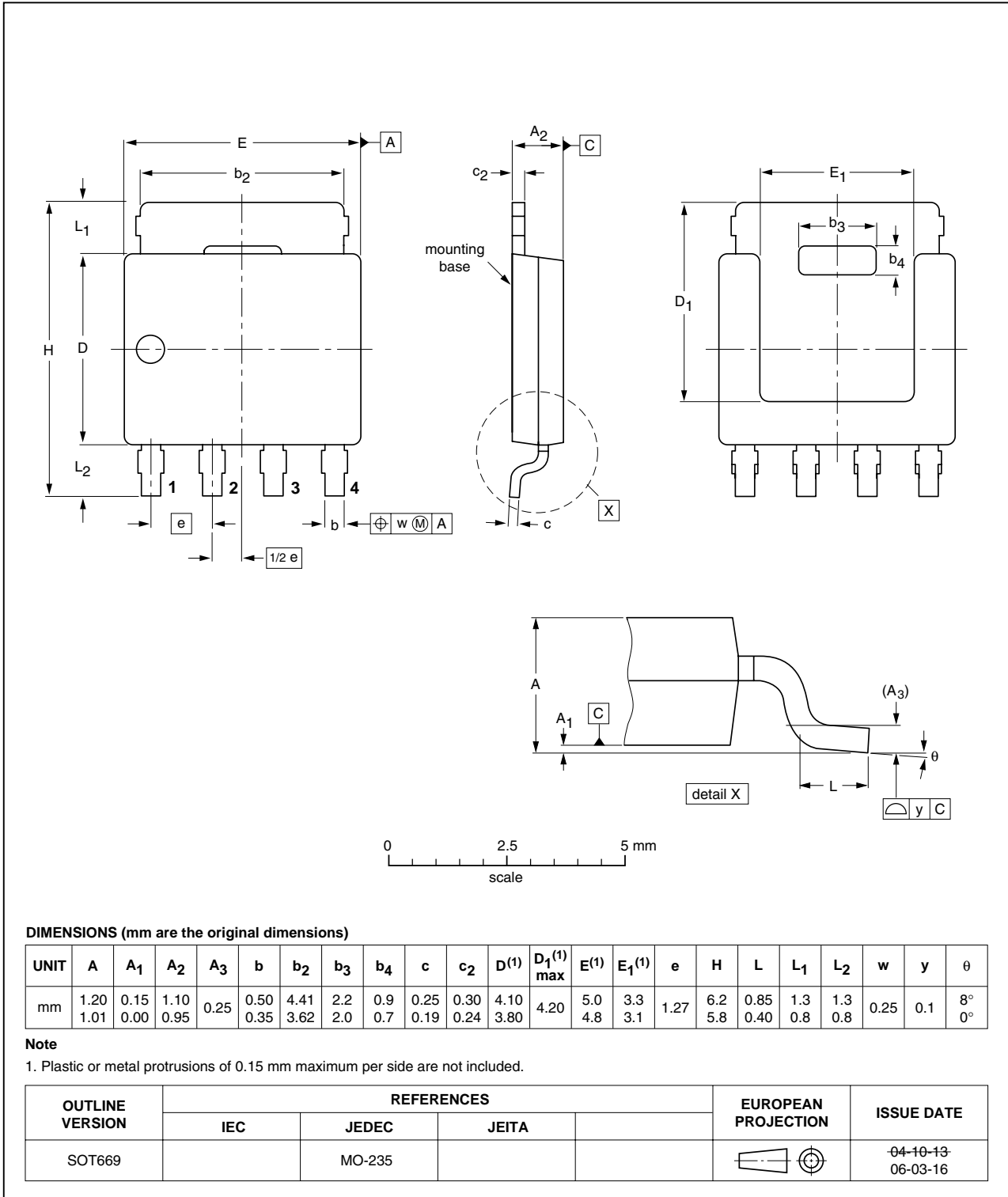

Fig 18. Package outline SOT669 (LPAK)

8. Revision history

Table 7. Revision history

Document ID	Release date	Data sheet status	Change notice	Supersedes
PSMN039-100YS_2	20100402	Product data sheet	-	PSMN039-100YS_1
Modifications:	• Status changed from Objective to Product.			
PSMN039-100YS_1	20100114	Objective data sheet	-	-

9. Legal information

9.1 Data sheet status

Document status [1][2]	Product status[3]	Definition
Objective [short] data sheet	Development	This document contains data from the objective specification for product development.
Preliminary [short] data sheet	Qualification	This document contains data from the preliminary specification.
Product [short] data sheet	Production	This document contains the product specification.

[1] Please consult the most recently issued document before initiating or completing a design.

[2] The term 'short data sheet' is explained in section "Definitions".

[3] The product status of device(s) described in this document may have changed since this document was published and may differ in case of multiple devices. The latest product status information is available on the Internet at URL <http://www.nexperia.com>.

9.2 Definitions

Draft — The document is a draft version only. The content is still under internal review and subject to formal approval, which may result in modifications or additions. Nexperia does not give any representations or warranties as to the accuracy or completeness of information included herein and shall have no liability for the consequences of use of such information.

Short data sheet — A short data sheet is an extract from a full data sheet with the same product type number(s) and title. A short data sheet is intended for quick reference only and should not be relied upon to contain detailed and full information. For detailed and full information see the relevant full data sheet, which is available on request via the local Nexperia sales office. In case of any inconsistency or conflict with the short data sheet, the full data sheet shall prevail.

Product specification — The information and data provided in a Product data sheet shall define the specification of the product as agreed between Nexperia and its customer, unless Nexperia and customer have explicitly agreed otherwise in writing. In no event however, shall an agreement be valid in which the Nexperia product is deemed to offer functions and qualities beyond those described in the Product data sheet.

9.3 Disclaimers

Limited warranty and liability — Information in this document is believed to be accurate and reliable. However, Nexperia does not give any representations or warranties, expressed or implied, as to the accuracy or completeness of such information and shall have no liability for the consequences of use of such information.

In no event shall Nexperia be liable for any indirect, incidental, punitive, special or consequential damages (including - without limitation - lost profits, lost savings, business interruption, costs related to the removal or replacement of any products or rework charges) whether or not such damages are based on tort (including negligence), warranty, breach of contract or any other legal theory.

Notwithstanding any damages that customer might incur for any reason whatsoever, Nexperia's aggregate and cumulative liability towards customer for the products described herein shall be limited in accordance with the *Terms and conditions of commercial sale* of Nexperia.

Right to make changes — Nexperia reserves the right to make changes to information published in this document, including without limitation specifications and product descriptions, at any time and without notice. This document supersedes and replaces all information supplied prior to the publication hereof.

Suitability for use — Nexperia products are not designed, authorized or warranted to be suitable for use in medical, military, aircraft, space or life support equipment, nor in applications where failure or malfunction of a Nexperia product can reasonably be expected to result in personal injury, death or severe property or environmental damage. Nexperia accepts no liability for inclusion and/or use of Nexperia products in such equipment or applications and therefore such inclusion and/or use is at the customer's own risk.

Applications — Applications that are described herein for any of these products are for illustrative purposes only. Nexperia makes no representation or warranty that such applications will be suitable for the specified use without further testing or modification.

Nexperia does not accept any liability related to any default, damage, costs or problem which is based on a weakness or default in the customer application/use or the application/use of customer's third party customer(s) (hereinafter both referred to as "Application"). It is customer's sole responsibility to check whether the Nexperia product is suitable and fit for the Application planned. Customer has to do all necessary testing for the Application in order to avoid a default of the Application and the product. Nexperia does not accept any liability in this respect.

Quick reference data — The Quick reference data is an extract of the product data given in the Limiting values and Characteristics sections of this document, and as such is not complete, exhaustive or legally binding.

Limiting values — Stress above one or more limiting values (as defined in the Absolute Maximum Ratings System of IEC 60134) will cause permanent damage to the device. Limiting values are stress ratings only and (proper) operation of the device at these or any other conditions above those given in the Recommended operating conditions section (if present) or the Characteristics sections of this document is not warranted. Constant or repeated exposure to limiting values will permanently and irreversibly affect the quality and reliability of the device.

Terms and conditions of commercial sale — Nexperia products are sold subject to the general terms and conditions of commercial sale, as published at <http://www.nexperia.com/profile/terms>, unless otherwise agreed in a valid written individual agreement. In case an individual agreement is concluded only the terms and conditions of the respective agreement shall apply. Nexperia hereby expressly objects to applying the customer's general terms and conditions with regard to the purchase of Nexperia products by customer.

No offer to sell or license — Nothing in this document may be interpreted or construed as an offer to sell products that is open for acceptance or the grant, conveyance or implication of any license under any copyrights, patents or other industrial or intellectual property rights.

Export control — This document as well as the item(s) described herein may be subject to export control regulations. Export might require a prior authorization from national authorities.

Non-automotive qualified products — Unless this data sheet expressly states that this specific Nexperia product is automotive qualified, the product is not suitable for automotive use. It is neither qualified nor tested in accordance with automotive testing or application requirements. Nexperia accepts no liability for inclusion and/or use of non-automotive qualified products in automotive equipment or applications.

In the event that customer uses the product for design-in and use in automotive applications to automotive specifications and standards, customer (a) shall use the product without Nexperia's warranty of the product for such automotive applications, use and specifications, and (b)

whenever customer uses the product for automotive applications beyond Nexperia's specifications such use shall be solely at customer's own risk, and (c) customer fully indemnifies Nexperia for any liability, damages or failed product claims resulting from customer design and use of the product for automotive applications beyond Nexperia's standard warranty and Nexperia's product specifications.

9.4 Trademarks

Notice: All referenced brands, product names, service names and trademarks are the property of their respective owners.

10. Contact information

For more information, please visit: <http://www.nexperia.com>

For sales office addresses, please send an email to: salesaddresses@nexperia.com

11. Contents

1	Product profile	1
1.1	General description	1
1.2	Features and benefits	1
1.3	Applications	1
1.4	Quick reference data	1
2	Pinning information	2
3	Ordering information	2
4	Limiting values	3
5	Thermal characteristics	5
6	Characteristics	6
7	Package outline	11
8	Revision history	12
9	Legal information	13
9.1	Data sheet status	13
9.2	Definitions	13
9.3	Disclaimers	13
9.4	Trademarks	14
10	Contact information	14