

Si5344-D EVALUATION BOARD USER'S GUIDE

Description

The Si5344-D-EVB is used for evaluating the Si5344 Any-Frequency, Any-Output, Jitter-Attenuating Clock Multiplier Revision D. The device revision is distinguished by a white 1 inch x 0.187 inch label with the text “Si5344-D-EB” installed in the lower left hand corner of the board. (For ordering purposes only, the terms “EB” and “EVB” refer to the board and the kit respectively. For the purpose of this document, the terms are synonymous in context.)

Features

- Powered from USB port or external power supply
- Onboard 48 MHz XTAL or Reference SMA Inputs allow holdover mode of operation on the Si5344.
- ClockBuilder® Pro (CBPro) GUI-programmable VDD supply allows device to operate from 3.3, 2.5, or 1.8 V.
- CBPro GUI-programmable VDDO supplies allow each of the 10 outputs to have its own supply voltage selectable from 3.3, 2.5, or 1.8 V
- CBPro GUI-controlled voltage, current, and power measurements of VDD and all VDDO supplies.
- Status LEDs for power supplies and control/status signals of Si5344
- SMA connectors for input clocks, output clocks, and optional external timing reference clock

Si5344-D Evaluation Board

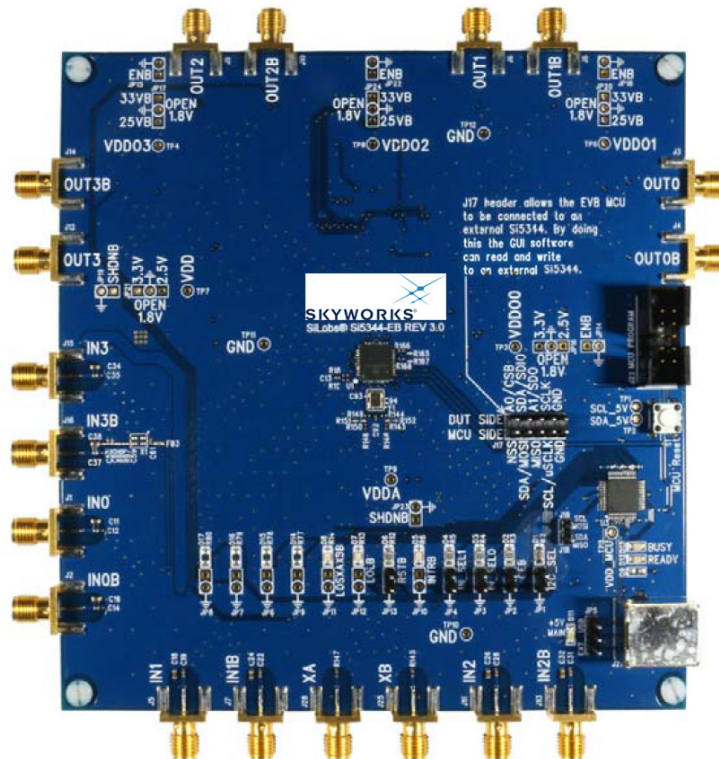

Si5344-D-EVB

1. Functional Block Diagram

Below is a functional block diagram of the Si5344-EB. This evaluation board can be connected to a PC via the main USB connector for programming, control, and monitoring. See Section “3. Quick Start” or Section “9. Installing ClockBuildPro (CBPro) Desktop Software” for more information.

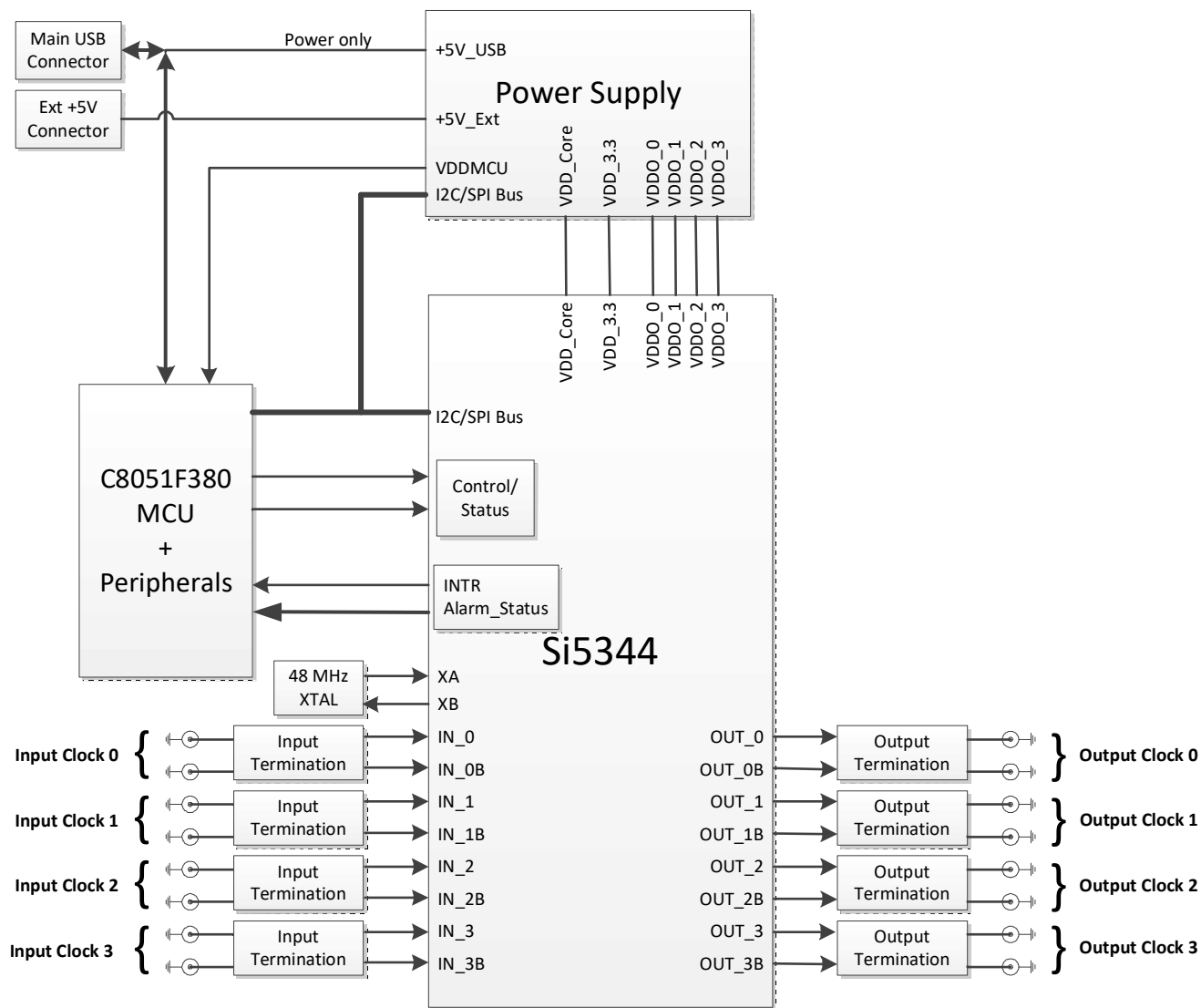

Figure 1. Si5344-EB Functional Block Diagram

2. Si5344-D-EVB Support Documentation and ClockBuilder® Pro Software

All Si5344 schematics, BOMs, User's Guides, and software can be found on-line at the following link:

www.skyworksinc.com/support-ia

3. Quick Start

1. Install ClockBuilder Pro desktop software:
www.skyworksinc.com/en/application-pages/clockbuilder-pro-software
2. Connect a USB cable from the Si5344-D-EB to the PC where the software is installed.
3. Confirm jumpers are installed as shown in Table 1.
4. Launch the ClockBuilder Pro Software.
5. You can use ClockBuilder Pro to create, download, and run a frequency plan on the Si5344-D-EB.
6. For the Si5344 data sheet go here: www.skyworksinc.com/en/Products/Timing

4. Jumper Defaults

Table 1. Si5344-D-EB Jumper Defaults

Location	Type	I = Installed 0 = Open		Location	Type	I = Installed 0 = Open
JP1	2 pin	I		JP14	2 pin	O
JP2	2 pin	I		JP15	2 pin	O
JP3	2 pin	I		JP16	3 pin	all open
JP4	2 pin	I		JP17	3 pin	all open
JP5	3 pin	1 to 2		JP18	2 pin	O
JP6	2 pin	O		JP19	2 pin	O
JP7	2 pin	O		JP20	3 pin	all open
JP8	2 pin	O		JP21	3 pin	all open
JP9	2 pin	O		JP22	2 pin	O
JP10	2 pin	O		JP23	2 pin	O
JP11	2 pin	O		JP24	3 pin	all open
JP12	2 pin	O		J17	5x2 Hdr	All 5 installed
JP13	2 pin	O				

***Note:** Refer to the Si534-D-EB Schematics for the functionality associated with each jumper.

5. Status LEDs

Table 2. Si5344-D-EB Status LEDs

Location	Silkscreen	Color	Status Function Indication
D5	INTRB	Blue	DUT Interrupt
D7	LOLB	Blue	DUT Loss of Lock
D8	LOSXAXB	Blue	DUT Loss of Reference
D11	+5V MAIN	Green	Main USB +5V present
D12	READY	Green	MCU Ready
D13	BUSY	Green	MCU Busy

D11 is illuminated when USB +5V supply voltage is present. D12 and D13 are status LEDs showing on-board MCU activity.

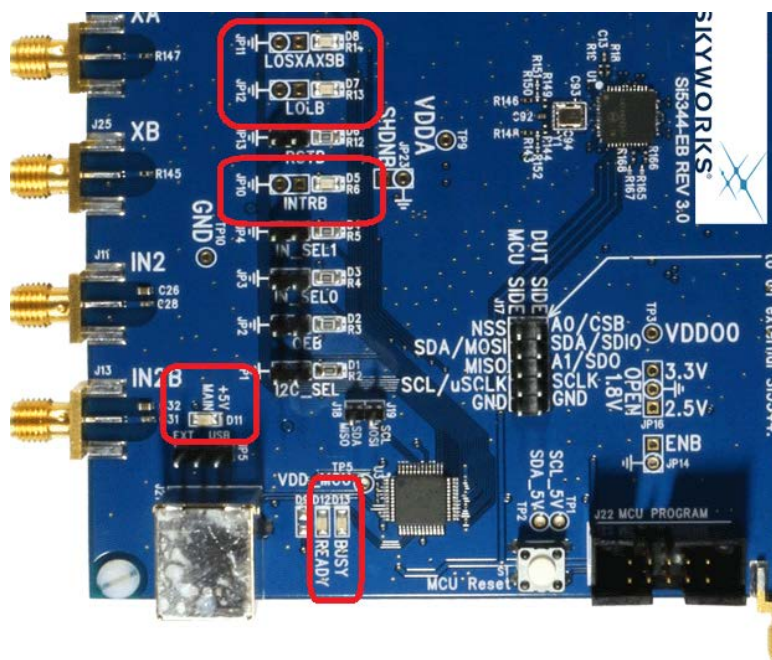

Figure 2. Status LEDs

Si5344-D-EVB

6. External Reference Input (XA/XB)

An external reference (XTAL) is used in combination with the internal oscillator to produce an ultra-low jitter reference clock for the DSPPLL and for providing a stable reference for the free-run and holdover modes. The Si5344-D-EB can also accommodate an external reference clock instead of a crystal. To evaluate the device with a REFCLK, C93 and C94 must be populated and the XTAL removed (see Figure 3). The REFCLK can then be applied to J25 and J26.

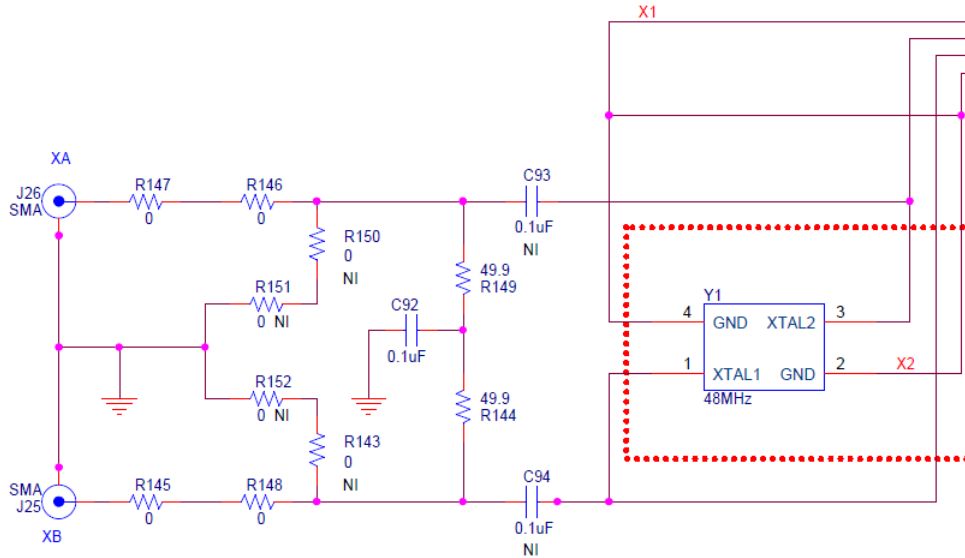

Figure 3. External Reference Input Circuit

7. Clock Input Circuits (INx/INxB and FB-IN/FB-INB)

The Si5344-D-EB has eight SMA connectors (IIN0/IN0B – IN2/IN2B and IN3(FB_IN)/IN3B(FB_INB)) for receiving external clock signals. All input clocks are terminated as shown in Figure 4.

Input clocks are ac-coupled and 50 Ω terminated. This represents four differential input clock pairs. Single-ended clocks can be used by appropriately driving one side of the differential pair with a single-ended clock. For details on how to configure inputs as single-ended, please refer to the Si5344 data sheet.

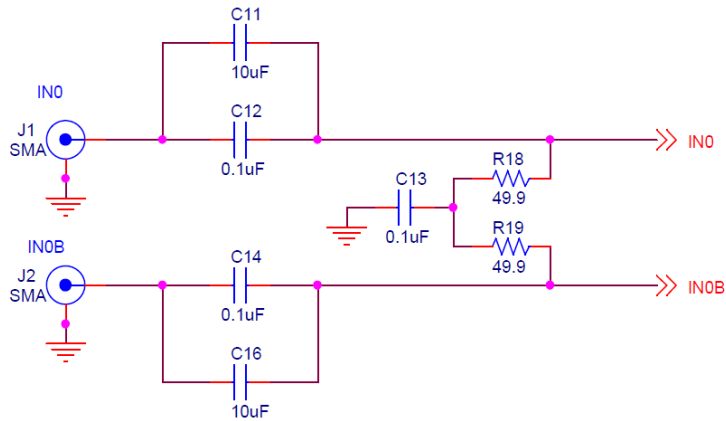

Figure 4. Input Clock Termination Circuit

8. Clock Output Circuits (OUTx/OUTxB)

Each of the eight outputs (four differential pairs) is ac-coupled to its respective SMA connector. The output clock termination circuit is shown in Figure 5. The output signal has no dc bias. If dc coupling is required, the ac coupling capacitors can be replaced with a resistor of appropriate value. The Si5344-D-EB provides pads for optional output termination resistors and/or low frequency capacitors.

Note: Components with schematic “NI” designation are not normally populated on the Si5344-D-EB and provide locations on the PCB for optional dc/ac terminations by the end user.

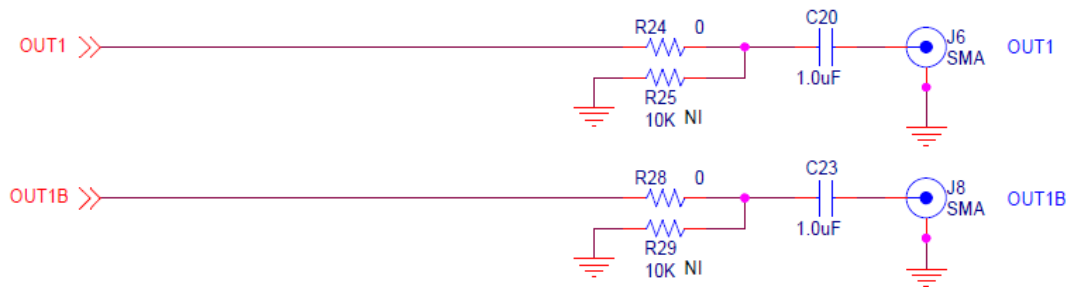

Figure 5. Output Clock Termination Circuit

9. Installing ClockBuildPro (CBPro) Desktop Software

To install the CBPro software on any Windows 7 (or later version) PC do the following:

1. Go to www.skyworksinc.com/en/application-pages/clockbuilder-pro-software and download ClockBuilder Pro software.
2. Installation instructions and User's Guide for ClockBuilder Pro can be found at the download link shown above. Please follow the instructions as indicated.

10. Using Si5344-D-EVB

10.1. Connecting the EVB to Your Host PC

Once ClockBuilder Pro software is installed, connect to the EVB with a USB cable as shown in Figure 6.

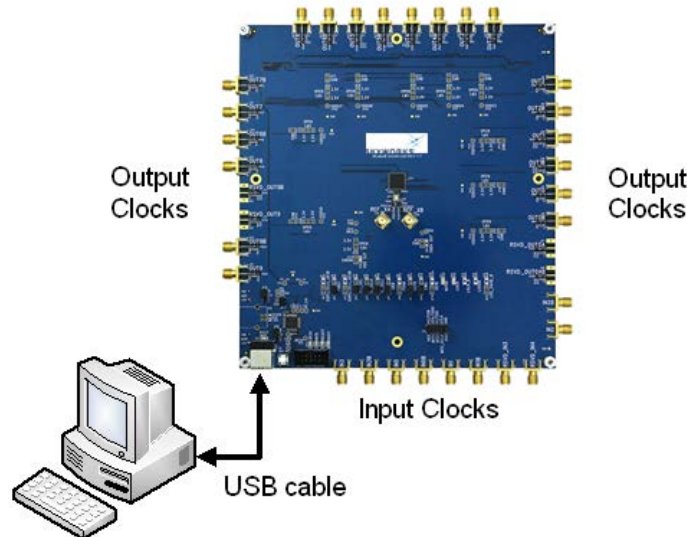

Figure 6. EVB Connection Diagram

10.2. Overview of ClockBuilder Pro Applications

The ClockBuilder Pro installer installs two main applications: the ClockBuilder Pro Wizard and the EVB GUI. Note: The following instructions and screen captures may vary slightly depending on your version of ClockBuilder Pro. The ClockBuilder Pro installer will install two main applications:

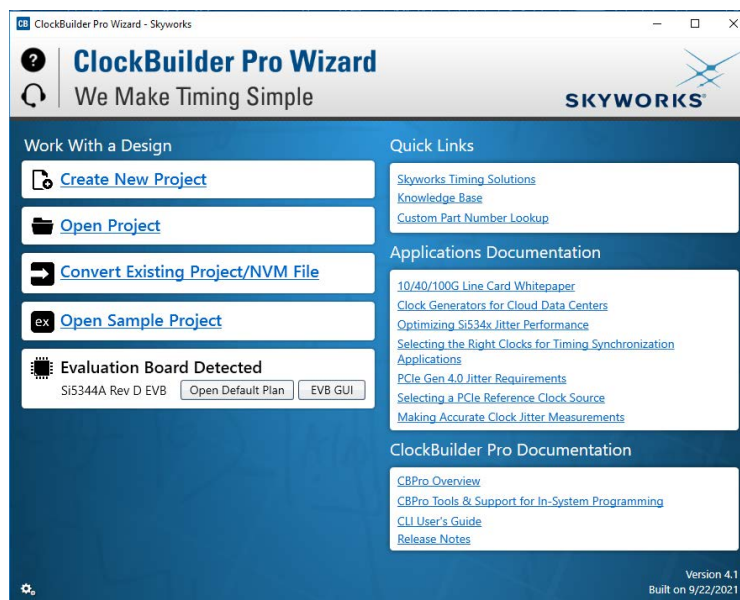

Figure 7. Application #1: ClockBuilder Pro Wizard

Si5344-D-EVB

Use the CBPro Wizard to do the following:

- Create a new design
- Review or edit an existing design
- Export: create in-system programming

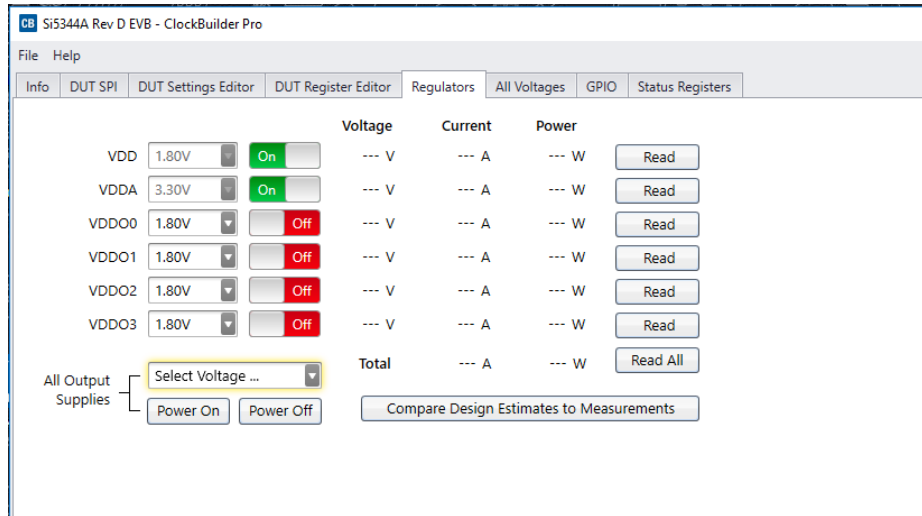

Figure 8. Application #2: EVB GUI

Use the EVB GUI to do the following:

- Download configuration to EVB's DUT (Si5344)
- Control the EVB's regulators
- Monitor voltage, current, power on the EVB

10.3. Common ClockBuilder Pro Work Flow Scenarios

There are three common workflow scenarios when using CBPro and the Si5344-D-EVB. These workflow scenarios are as follows:

- Workflow Scenario #1: Testing a Skyworks-created Default Configuration
- Workflow Scenario #2: Modifying the Default Skyworks-created Device Configuration
- Workflow Scenario #3: Testing a User-created Device Configuration

Each is described in more detail in the following sections.

10.3.1. Workflow Scenario #1: Testing a Skyworks Created Default Configuration

The flow for using the EVB GUI to initialize and control a device on the EVB is as follows.

1. Once the PC and EVB are connected, launch ClockBuilder Pro by clicking on this icon on your PC's desktop.



Figure 9. ClockBuilder Pro Desktop Icon

2. When the EVB is detected, click on the **Open Default Plan** button on the Wizard's main menu. CBPro automatically detects the EVB and device type.

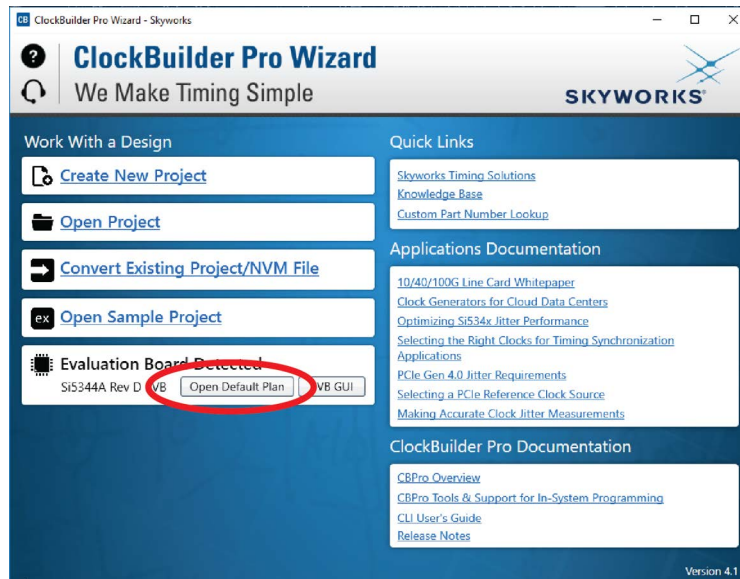

Figure 10. Open Default Plan

3. Once you open the default plan (based on your EVB model number), a popup window opens.

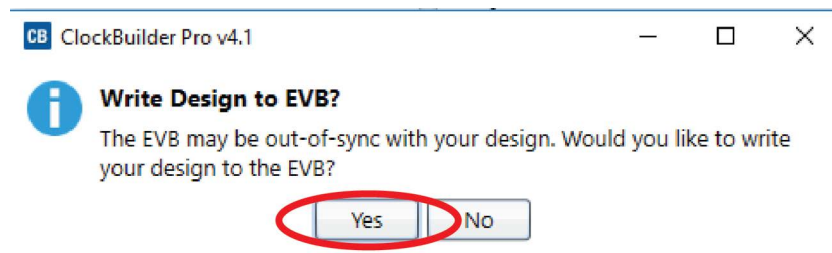

Figure 11. Write Design to EVB Dialog

4. Select **Yes** to write the default plan to the Si5344 device mounted on your EVB. This ensures the device is completely reconfigured per the Skyworks default plan for the DUT type mounted on the EVB.

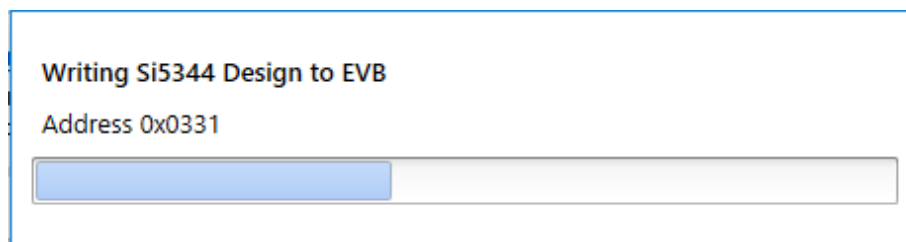

Figure 12. Writing Design Status

Si5344-D-EVB

5. After CBPro writes the default plan to the EVB, click on **Open EVB GUI**.

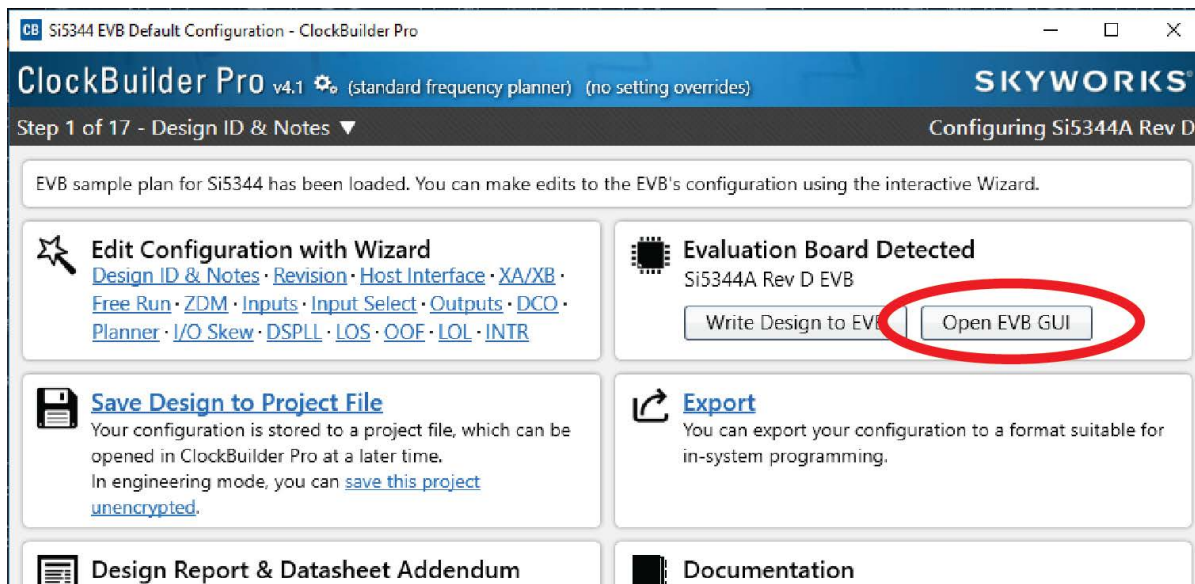

Figure 13. Open EVB GUI

6. The EVB GUI opens. All power supplies are set to the values defined in the device's default CBPro project file created by Skyworks, as shown in Figure 14.

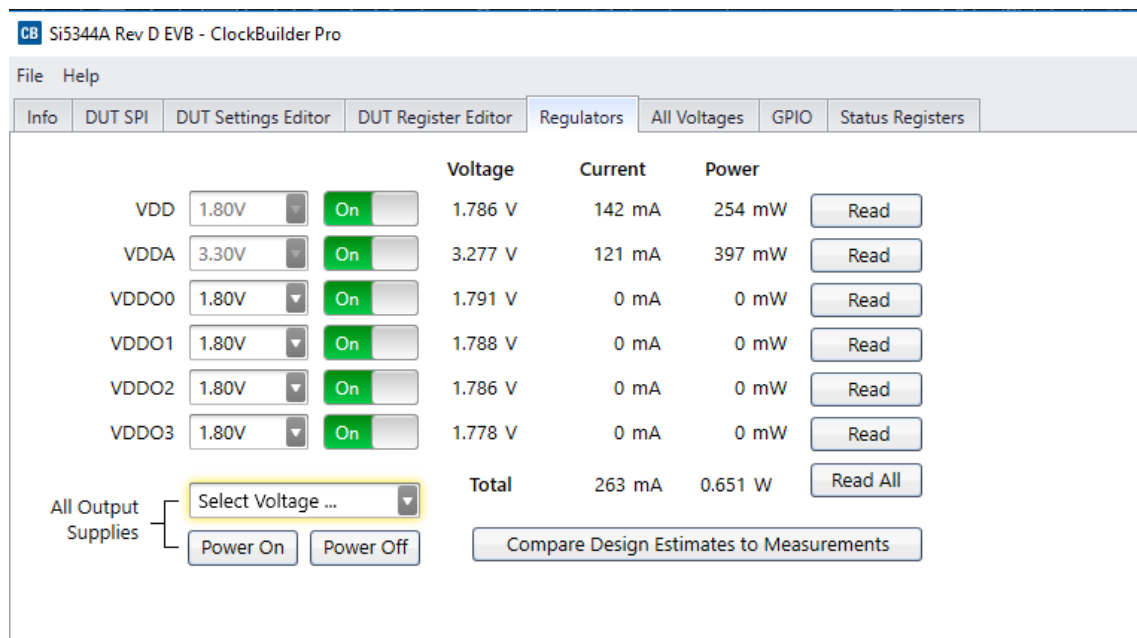

Figure 14. EVB GUI Window

Verify Free-run Mode Operation

Assuming no external clocks have been connected to the INPUT CLOCK differential SMA connectors (labeled “INx/INxB”) located around the perimeter of the EVB, the DUT should now be operating in free-run mode, as the DUT will be locked to the crystal in this case.

You can run a quick check to determine if the device is powered up and generating output clocks (and consuming power) by clicking on the Read All button (bottom right-hand corner of Figure 14) and then reviewing the voltage, current, and power readings for each VDDx supply.

Note: Shutting the VDD and VDDA power supplies “Off” and then “On” will power-down and reset the DUT. Every time you do this, to reload the Skyworks-created default plan into the DUT’s register space, you must go back to the Wizard’s main menu and select **Write Design to EVB**.

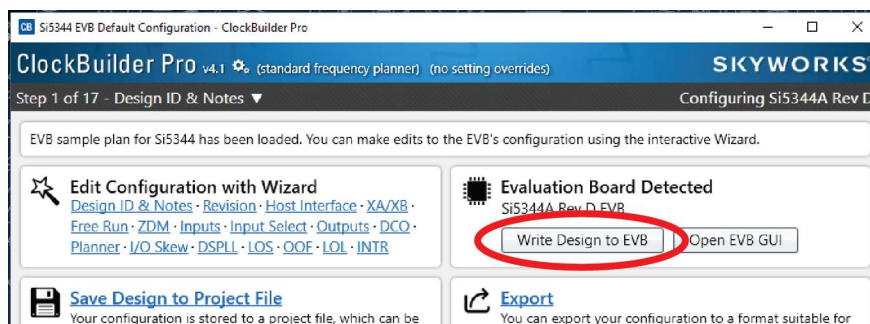

Figure 15. Write Design to EVB

Failure to do the step above will cause the device to read in a pre-programmed plan from its non-volatile memory (NVM). However, the plan loaded from the NVM may not be the latest plan recommended by Skyworks for evaluation.

At this point, you should verify the presence and frequencies of the output clocks (running in free-run mode from the crystal) using appropriate external instrumentation connected to the output clock SMA connectors. To verify the output clocks are toggling at the correct frequency and signal format, click on **View Design Report** as highlighted in Figure 16.

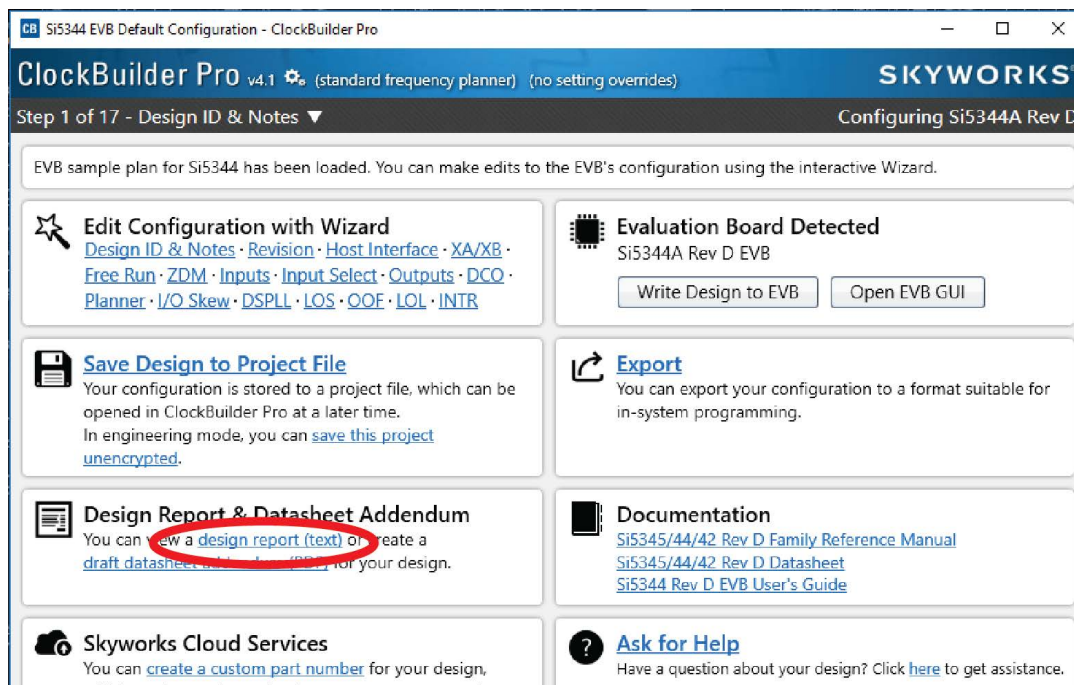

Figure 16. View Design Report

Si5344-D-EVB

Your configuration's design report opens in a new window, as shown in Figure 17. Compare the observed output clocks to the frequencies and formats noted in your default project's Design Report.

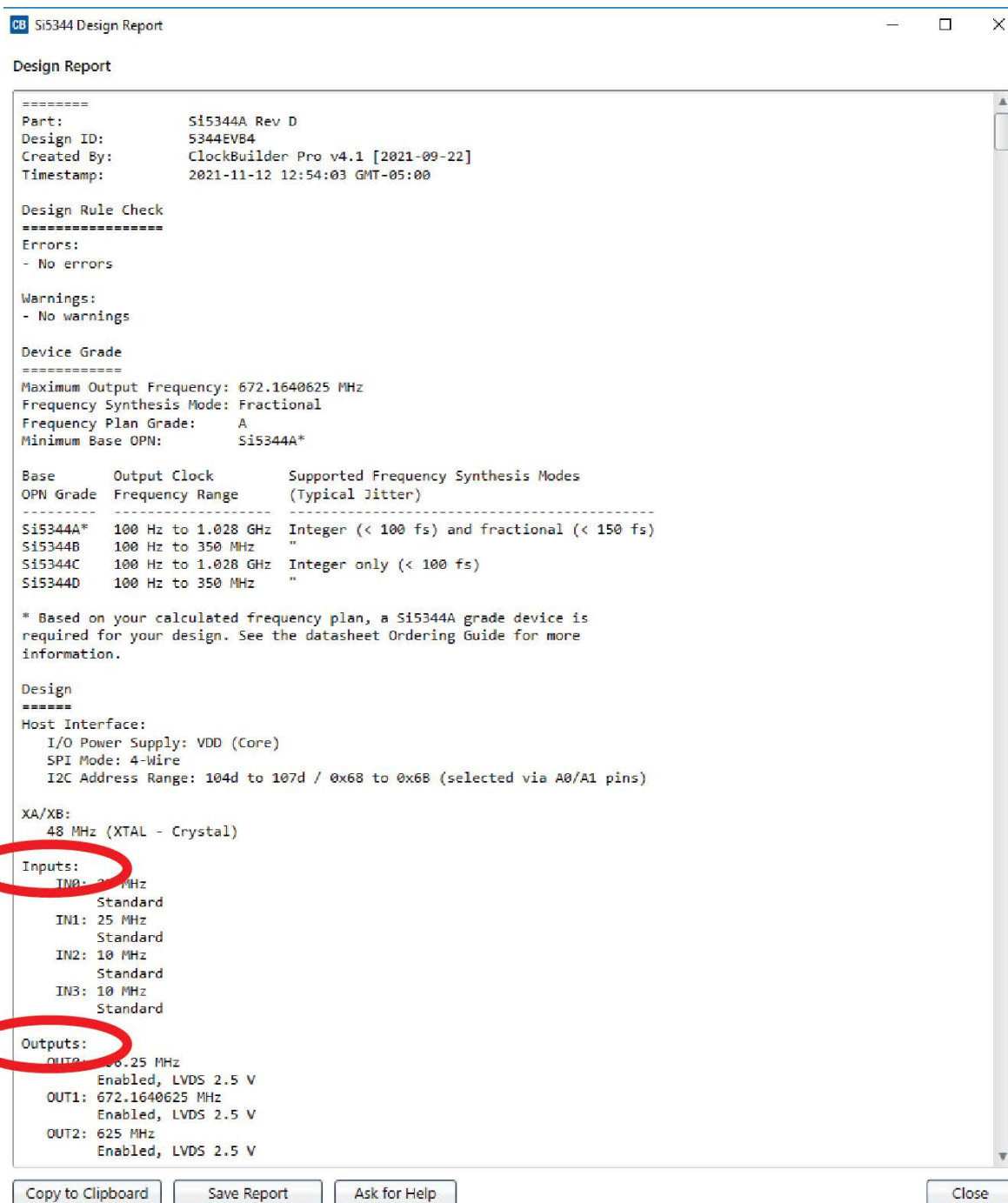

Figure 17. Design Report Window

Verify Locked Mode Operation

Assuming you connect the correct input clocks to the EVB (as noted in the Design Report shown above), the DUT on your EVB will be running in “locked” mode.

10.3.2. Workflow Scenario #2: Modifying the Default Skyworks Created Device Configuration

To modify the “default” configuration using the CBPro Wizard, click on **Edit Configuration with Wizard**.

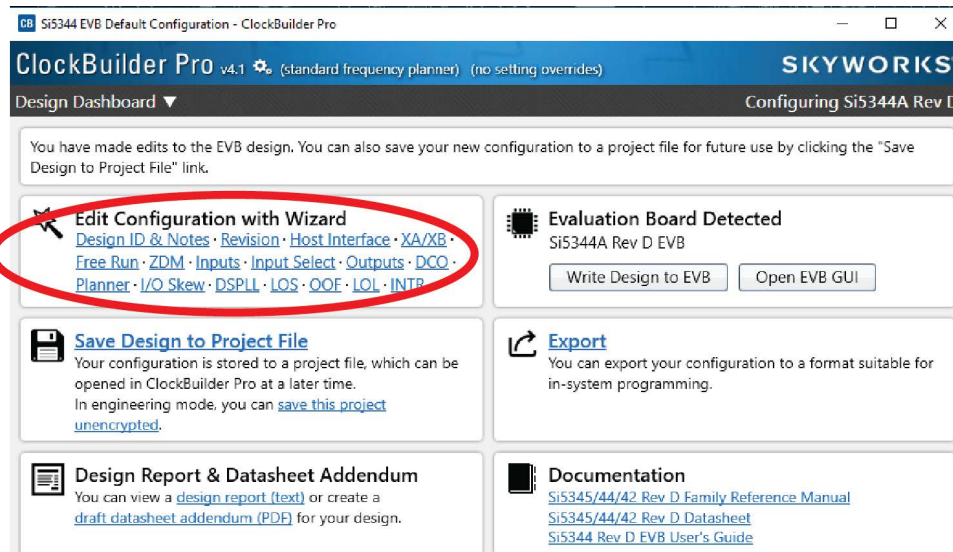

Figure 18. Edit Configuration with Wizard

You will now be taken to the Wizard’s step-by-step menus to allow you to change any of the default plan’s operating configurations.

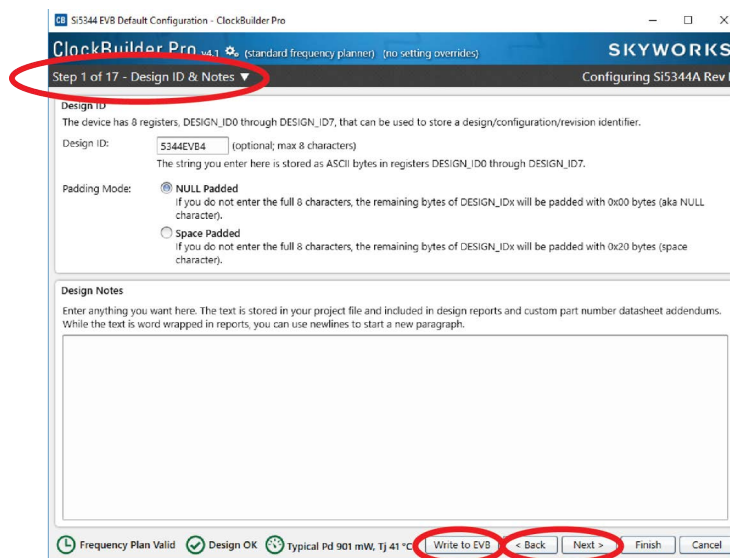

Figure 19. Design Wizard

Note: You can click on the icon on the lower left hand of the menu to confirm that your frequency plan is valid. After making your desired changes, you can click on **Write to EVB** to update the DUT to reconfigure your device in real-time. The Design Write status window opens each time you make a change.

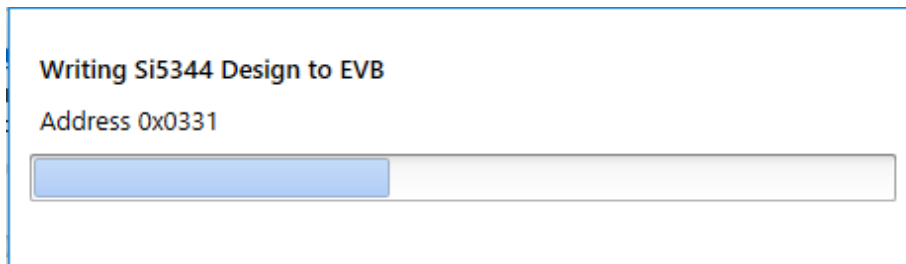

Figure 20. Writing Design Status

10.3.3. Workflow Scenario #3: Testing a User Created Device Configuration

1. To test a previously-created user configuration, open the CBPro Wizard by clicking the icon on your desktop and then selecting **Open Design Project File**.

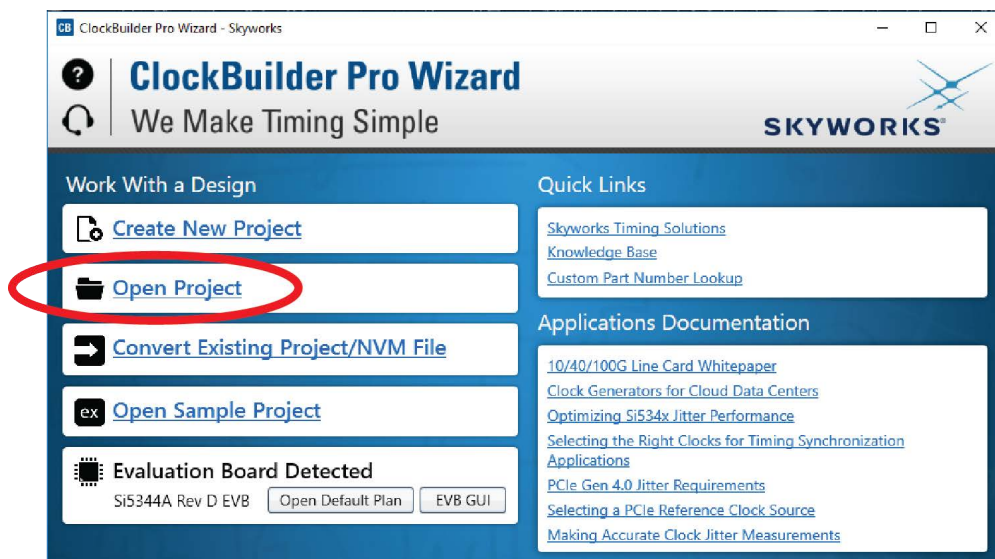

Figure 21. Open Design Project File

2. Locate your CBPro design file in the Windows file browser.

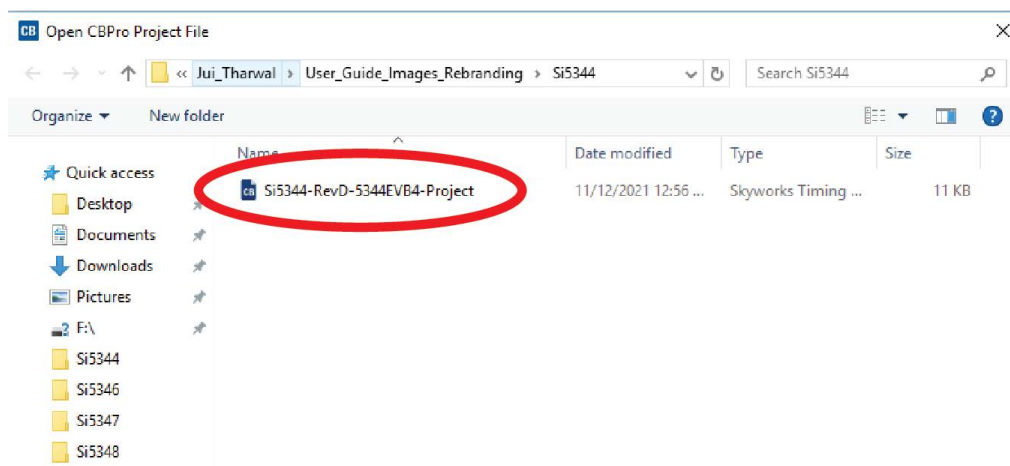

Figure 22. Browse to Project File

3. Select Yes when the WRITE DESIGN to EVB popup appears:

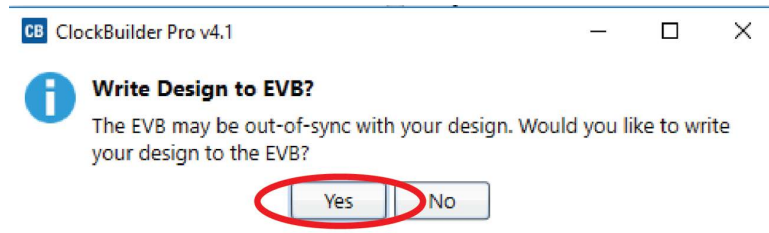

Figure 23. Write Design to EVB Dialog

4. The progress bar is launched. Once the new design project file has been written to the device, verify the presence and frequencies of your output clocks and other operating configurations using external instrumentation.

10.4. Exporting the Register Map File for Device Programming by a Host Processor

You can also export your configuration to a file format suitable for in-system programming by selecting **Export** as shown in Figure 24.

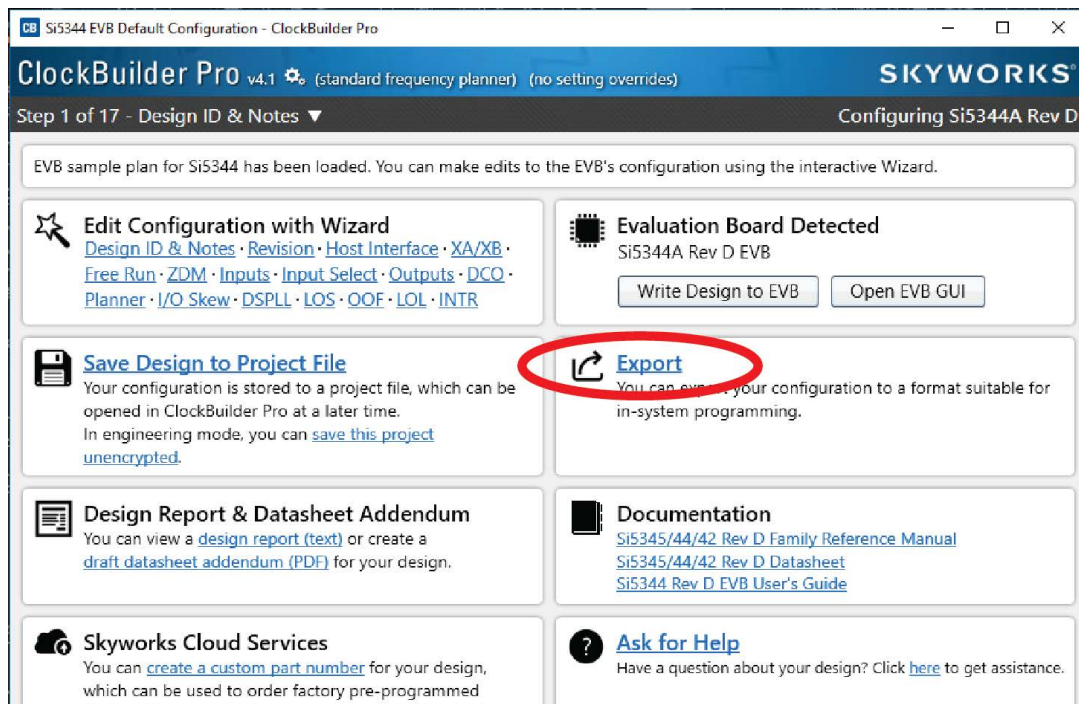

Figure 24. Export Register Map File

You can now write your device's complete configuration to file formats suitable for in-system programming.

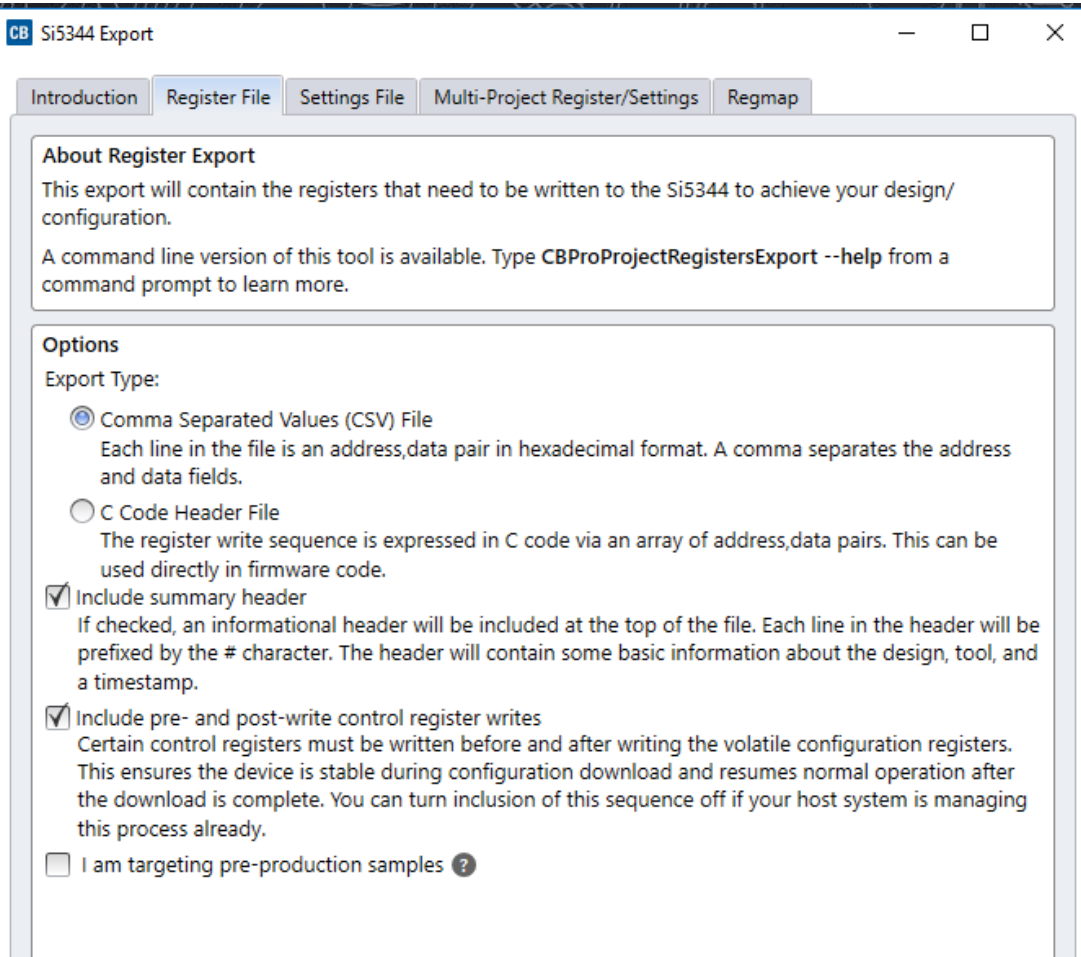

Figure 25. Export Settings

11. Writing A New Frequency Plan or Device Configuration to Non-volatile Memory (OTP)

Note: Writing to the device non-volatile memory (OTP) is NOT the same as writing a configuration into the Si5344 using ClockBuilder Pro on the Si5344-D-EB. Writing a configuration into the EVB from ClockBuilder Pro is done using Si5344 RAM space and can be done virtually unlimited number of times. Writing to OTP is limited as described below.

Refer to the Si534x/8x Family Reference Manuals and device datasheets for information on how to write a configuration to the EVB DUT's non-volatile memory (OTP). The OTP can be programmed a maximum of two times only. Care must be taken to ensure the configuration desired is valid when choosing to write to OTP.

12. Serial Device Communications (Si5344 \longleftrightarrow MCU)

12.1. On-Board SPI Support

The MCU on-board the Si5344-D-EB communicates with the Si5344 device through a 4-wire SPI (Serial Peripheral Interface) link. The MCU is the SPI master and the Si5344 device is the SPI slave. The Si5344 device can also support a 2-wire I²C serial interface, although the Si5344-D-EB does NOT support the I²C mode of operation. SPI mode was chosen for the EVB because of the relatively higher speed transfers supported by SPI vs. I²C.

12.2. External I²C Support

I²C can be supported if driven from an external I²C controller. The serial interface signals between the MCU and Si5344 pass through shunts loaded on header J17. These jumper shunts must be installed in J17 for normal EVB operation using SPI with CBPro. If testing of I²C operation via external controller is desired, the shunts in J17 can be removed thereby isolating the on-board MCU from the Si5344 device. The shunt at JP1 (I²C_SEL) must also be removed to select I²C as Si5344 interface type. An external I²C controller connected to the Si5344 side of J17 can then communicate to the Si5344 device. (For more information on I²C signal protocol, please refer to the Si5344 data sheet.)

Figure 26 below illustrates the J17 header schematic. J17 even numbered pins (2, 4, 6, etc.) connect to the Si5344 device and the odd numbered pins (1, 3, 5, etc.) connect to the MCU. Once the jumper shunts have been removed from J17 and JP1, I²C operation should use J17 pin 4 (DUT_SDA_SDIO) as the I²C SDA and J17 pin 8 (DUT_SCLK) as the I²C SCLK. Please note the external I²C controller will need to supply its own I²C signal pull-up resistors.

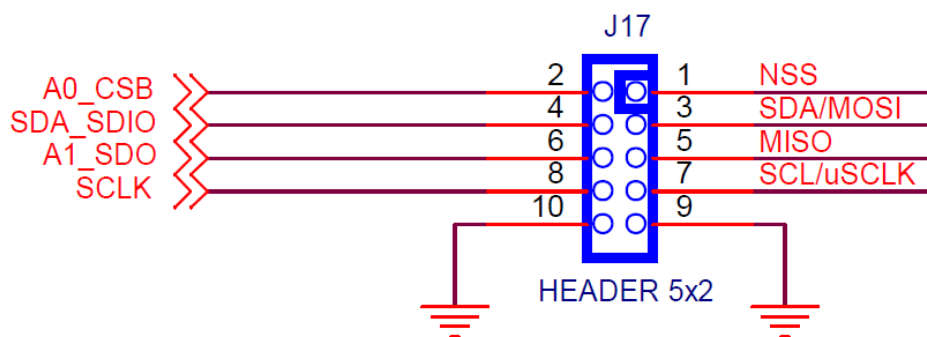

Figure 26. Serial Communications Header J17

Si5344-D-EVB

13. Si5344-D-EB Schematic and Bill of Materials (BOM)

The Si5344-D-EB Schematic and Bill of Materials (BOM) can be found online at:

www.skyworksinc.com/support-ia

Please be aware the Si5344-D-VB schematic is in OrCad Capture hierarchical format and not in a typical “flat” schematic format.



SKYWORKS®

ClockBuilder Pro

Customize Skyworks clock generators, jitter attenuators and network synchronizers with a single tool. With CBPro you can control evaluation boards, access documentation, request a custom part number, export for in-system programming and more!

www.skyworksinc.com/CBPro



Portfolio

www.skyworksinc.com/ia/timing



SW/HW

www.skyworksinc.com/CBPro

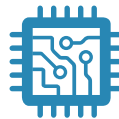

Quality

www.skyworksinc.com/quality



Support & Resources

www.skyworksinc.com/support

Copyright © 2021 Skyworks Solutions, Inc. All Rights Reserved.

Information in this document is provided in connection with Skyworks Solutions, Inc. ("Skyworks") products or services. These materials, including the information contained herein, are provided by Skyworks as a service to its customers and may be used for informational purposes only by the customer. Skyworks assumes no responsibility for errors or omissions in these materials or the information contained herein. Skyworks may change its documentation, products, services, specifications or product descriptions at any time, without notice. Skyworks makes no commitment to update the materials or information and shall have no responsibility whatsoever for conflicts, incompatibilities, or other difficulties arising from any future changes.

No license, whether express, implied, by estoppel or otherwise, is granted to any intellectual property rights by this document. Skyworks assumes no liability for any materials, products or information provided hereunder, including the sale, distribution, reproduction or use of Skyworks products, information or materials, except as may be provided in Skyworks' Terms and Conditions of Sale.

THE MATERIALS, PRODUCTS AND INFORMATION ARE PROVIDED "AS IS" WITHOUT WARRANTY OF ANY KIND, WHETHER EXPRESS, IMPLIED, STATUTORY, OR OTHERWISE, INCLUDING FITNESS FOR A PARTICULAR PURPOSE OR USE, MERCHANTABILITY, PERFORMANCE, QUALITY OR NON-INFRINGEMENT OF ANY INTELLECTUAL PROPERTY RIGHT; ALL SUCH WARRANTIES ARE HEREBY EXPRESSLY DISCLAIMED. SKYWORKS DOES NOT WARRANT THE ACCURACY OR COMPLETENESS OF THE INFORMATION, TEXT, GRAPHICS OR OTHER ITEMS CONTAINED WITHIN THESE MATERIALS. SKYWORKS SHALL NOT BE LIABLE FOR ANY DAMAGES, INCLUDING BUT NOT LIMITED TO ANY SPECIAL, INDIRECT, INCIDENTAL, STATUTORY, OR CONSEQUENTIAL DAMAGES, INCLUDING WITHOUT LIMITATION, LOST REVENUES OR LOST PROFITS THAT MAY RESULT FROM THE USE OF THE MATERIALS OR INFORMATION, WHETHER OR NOT THE RECIPIENT OF MATERIALS HAS BEEN ADVISED OF THE POSSIBILITY OF SUCH DAMAGE.

Skyworks products are not intended for use in medical, lifesaving or life-sustaining applications, or other equipment in which the failure of the Skyworks products could lead to personal injury, death, physical or environmental damage. Skyworks customers using or selling Skyworks products for use in such applications do so at their own risk and agree to fully indemnify Skyworks for any damages resulting from such improper use or sale.

Customers are responsible for their products and applications using Skyworks products, which may deviate from published specifications as a result of design defects, errors, or operation of products outside of published parameters or design specifications. Customers should include design and operating safeguards to minimize these and other risks. Skyworks assumes no liability for applications assistance, customer product design, or damage to any equipment resulting from the use of Skyworks products outside of Skyworks' published specifications or parameters.

Skyworks, the Skyworks symbol, Sky5®, SkyOne®, SkyBlue™, Skyworks Green™, Clockbuilder®, DSPLL®, ISOModem®, ProSLIC®, and SiPHY® are trademarks or registered trademarks of Skyworks Solutions, Inc. or its subsidiaries in the United States and other countries. Third-party brands and names are for identification purposes only and are the property of their respective owners. Additional information, including relevant terms and conditions, posted at www.skyworksinc.com, are incorporated by reference.