

Uni- and Bipolar Hall IC Switches for Magnetic Field Applications

TLE 4905 G; TLE 4935 G
TLE 4935-2 G; TLE 4945-2 G

Bipolar IC

Features

- Temperature compensated magnetic performance
- Digital output signal
- For unipolar and alternating magnetic fields
- Large temperature range
- Protection against reversed polarity
- Output protection against electrical disturbances

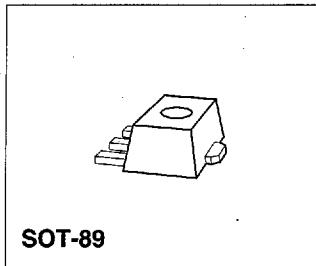

Type	Ordering Code	Package
TLE 4905 G	Q62705-K402	SOT-89
TLE 4935 G	Q62705-K404	SOT-89
TLE 4935-2 G	Q62705-K405	SOT-89
TLE 4945-2 G	Q62705-K403	SOT-89

TLE 4905/35/35-2/45-2 (Unipolar/Bipolar Magnetic Field Switches) have been designed specifically for automotive and industrial applications. Reverse polarity protection is included on-chip as is output protection against negative voltage transients.

Typical applications are position/proximity indicators, brushless DC motor commutation, rotational indexing etc.

■ 8235605 0134275 433 ■

Pin Configuration
(top view)

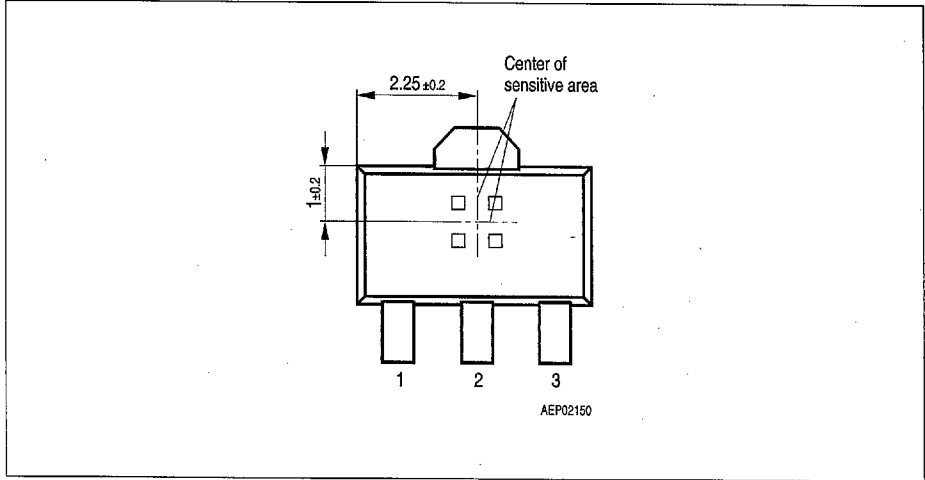

Figure 1

Pin Definitions and Functions

Pin No.	Symbol	Function
1	V_s	Supply voltage
2	GND	Ground
3	Q	Output

8235605 0134276 37T

Circuit Description

The circuit includes Hall generator, amplifier and Schmitt-Trigger on one chip. The internal reference provides the supply voltage for the components. A magnetic field perpendicular to the chip surface induces a voltage at the hall probe. This voltage is amplified and switches a Schmitt-trigger with open-collector output. A protection diode against reverse power supply is integrated.

The output is protected against electrical disturbances.

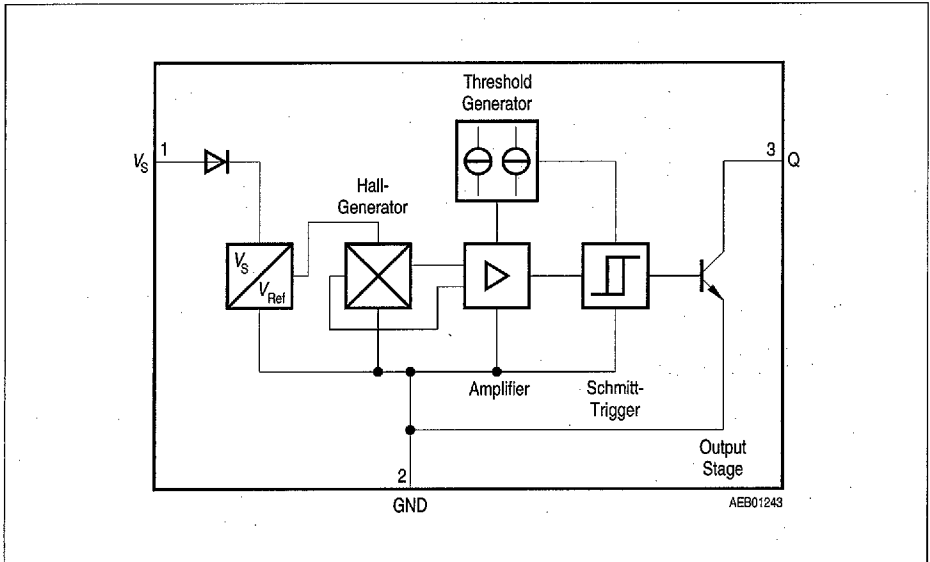

Figure 2 Block Diagram

8235605 0134277 206

Functional Description Unipolar Type TLE 4905 (Figure 3 and 4)

When a positive magnetic field is applied in the indicated direction (**Figure 3**) and the turn-on magnetic induction B_{OP} is exceeded, the output of the Hall-effect IC will conduct (Operate Point). When the magnetic field is reduced to a value smaller than the release point, the output of the IC turns off (Release Point; **Figure 4**).

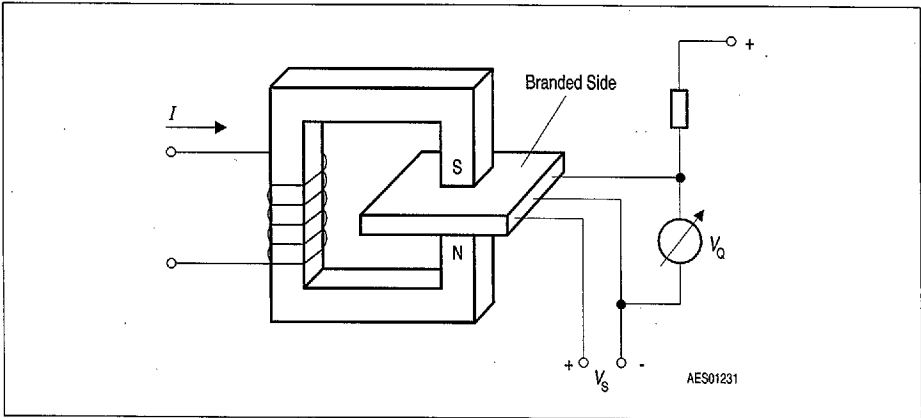

Figure 3 Sensor/Magnetic-Field Configuration

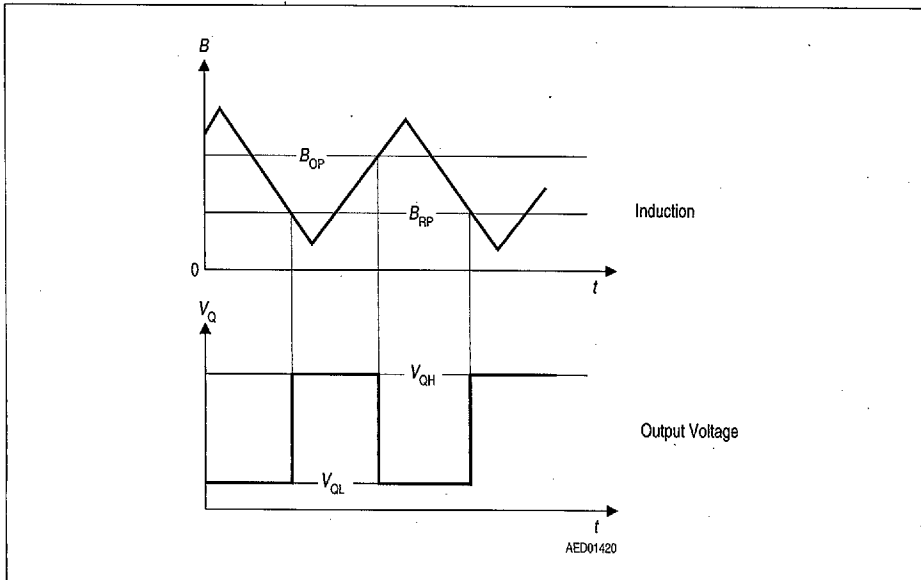

Figure 4 Switching Characteristics Unipolar Type

Functional Description Bipolar Type TLE 4935/35-2/45-2 (Figure 5 and 6)

When a positive magnetic field is applied in the indicated direction (**Figure 5**) and the turn-on magnetic induction B_{OP} is exceeded, the output of the Hall-effect IC will conduct (Operate Point). The output state does not change unless a reverse magnetic field exceeding the turn-off magnetic induction $|B_{RP}|$ is exceeded. In this case the output will turn off (Release Point; **Figure 6**).

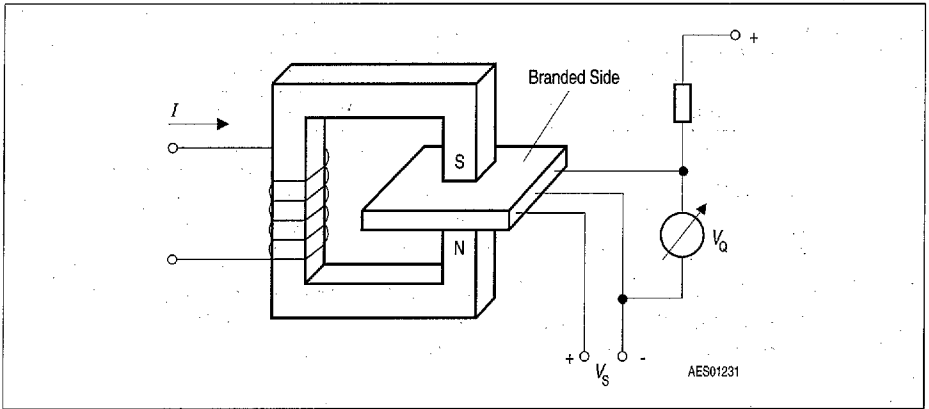

Figure 5 Sensor/Magnetic-Field Configuration

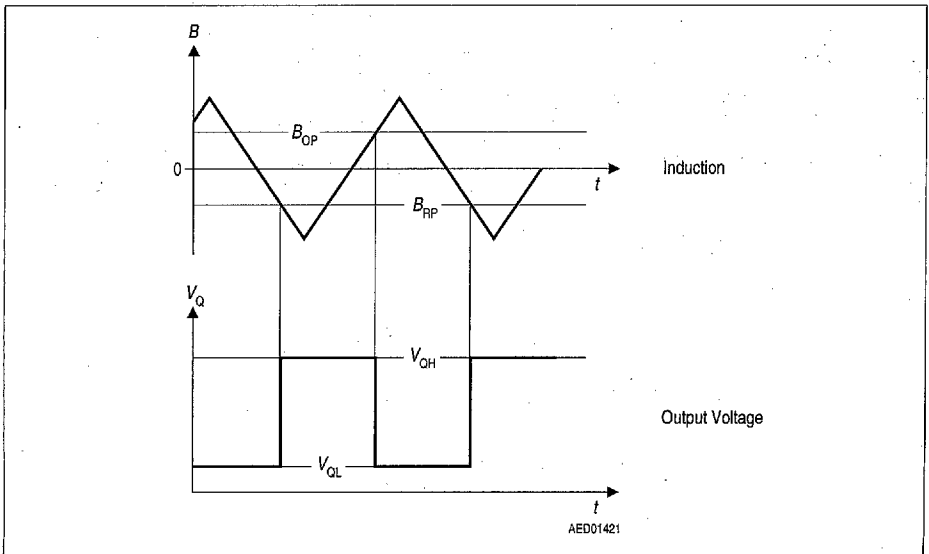

Figure 6 Switching Characteristics Bipolar Type

Absolute Maximum Ratings

$T_j = -40$ to 150 °C

Parameter	Symbol	Limit Values		Unit	Remarks
		min.	max.		
Supply voltage	V_S	-40	32	V	-
Supply voltage	V_S	-	40	V	$t < 400$ ms; $v = 0.1$
Output voltage	V_Q	-	32	V	-
Output current	I_Q	-	100	mA	-
Output reverse current	$-I_Q$	-	100	mA	-
Junction temperature	T_j	-40	150	°C	-
Storage temperature	T_{stg}	-50	150	°C	-
Thermal resistance	$R_{th,JA}$		100	K/W	-

Note: Stresses above those listed here may cause permanent damage to the device. Exposure to absolute maximum rating conditions for extended periods may affect device reliability.

Operating Range

Parameter	Symbol	Limit Values		Unit	Remarks
		min.	max.		
Supply voltage	V_S	4.0	18	V	-
Junction temperature	T_j	-40	125	°C	-

Note: In the operating range the functions given in the circuit description are fulfilled.

■ 8235605 0134280 8T0 ■

AC/DC Characteristics

$4.0\text{ V} \leq V_S \leq 24\text{ V}$; $-40\text{ }^\circ\text{C} \leq T_j \leq 150\text{ }^\circ\text{C}$

Parameter	Symbol	Limit Values			Unit	Test Condition	Test Circuit
		min.	typ.	max.			
Supply current	I	1.6	–	5.0	mA		1
	I_{SHigh}	–	2.5	–	mA	$B < B_{\text{RP}}$	1
	I_{SLow}	–	3.5	–	mA	$B > B_{\text{OP}}$	1
Output saturation voltage	V_{QSat}	–	0.25	0.5	V	$I_{\text{Q}} = 40\text{ mA}$	1
Output leakage current	I_{QL}	–	–	10	μA	$V_{\text{Q}} = 18\text{ V}$	1
Rise/fall time	t_r / t_f	–	–	1	μs	$R_L = 1.2\text{ k}\Omega$ $C_L \leq 33\text{ pF}$	1

Note: The listed characteristics are ensured over the operating range of the integrated circuit. Typical characteristics specify mean values expected over the production spread. If not otherwise specified, typical characteristics apply at $T_j = 25\text{ }^\circ\text{C}$ and the given supply voltage.

Note: Moderate changes may occur during the development process or customer discussion.

8235605 0134281 737

Magnetic Characteristics

4.0 V ≤ V_S ≤ 24 V

Parameter	Symbol	Limit Values								Unit
		TLE 4905 unipolar		TLE 4935 bipolar latch		TLE 4935-2 bipolar latch		TLE 4945-2 bipolar switch		
		min.	max.	min.	max.	min.	max.	min.	max.	

Junction Temperature T_j = -40 °C

Turn-ON induction	B _{OP}	7.5	19	10	20	15	27	-3	6	mT
Turn-OFF induction	B _{RP}	5.5	17	-20	-10	-27	-15	-6	3	mT
Hysteresis (B _{OP} -B _{RP})	ΔB _{HY}	2	6.5	20	40	30	54	1	5	mT

Junction Temperature T_j = 25 °C

Turn-ON induction	B _{OP}	7	18	10	20	14	26	-3	6	mT
Turn-OFF induction	B _{RP}	5	16	-20	-10	-26	-14	-6	3	mT
Hysteresis (B _{OP} -B _{RP})	ΔB _{HY}	2	6	20	40	28	52	1	5	mT

Junction Temperature T_j = 85 °C

Turn-ON induction	B _{OP}	6.5	17.5	10	20	13	26	-3	6	mT
Turn-OFF induction	B _{RP}	4.5	15	-20	-10	-26	-13	-6	3	mT
Hysteresis (B _{OP} -B _{RP})	ΔB _{HY}	2	5.5	20	40	26	52	1	5	mT

Junction Temperature T_j = 125 °C

Turn-ON induction	B _{OP}	6	17	10	20	12	25	-3	6	mT
Turn-OFF induction	B _{RP}	4	14	-20	-10	-25	-12	-6	3	mT
Hysteresis (B _{OP} -B _{RP})	ΔB _{HY}	2	5	20	40	24	50	1	5	mT

Note: The listed characteristics are ensured over the operating range of the integrated circuit. Typical characteristics specify mean values expected over the production spread. If not otherwise specified, typical characteristics apply at T_j = 25 °C and the given supply voltage.

8235605 0134282 673

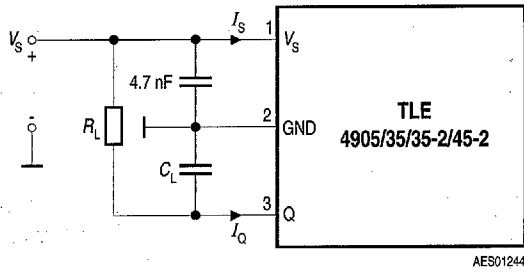

Unipolar Type TLE 4905

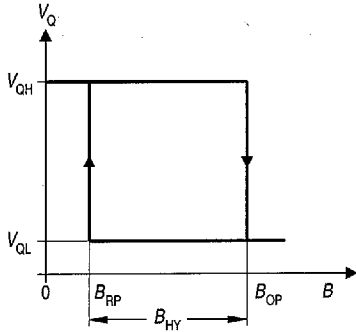

Bipolar Type TLE 4935

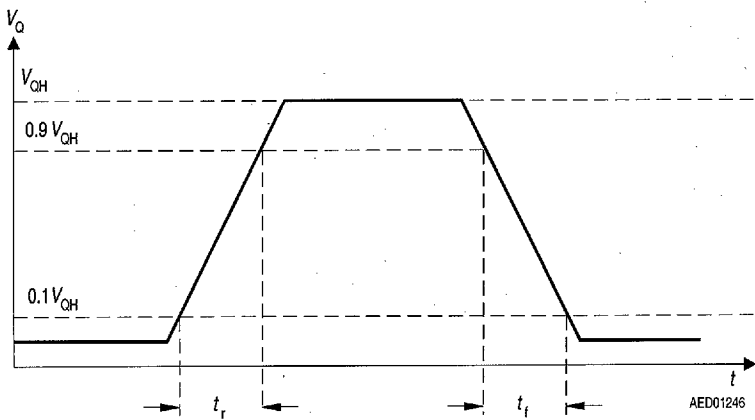
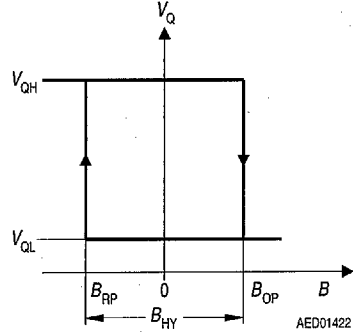

Figure 7 Test Circuit 1

8235605 0134283 50T

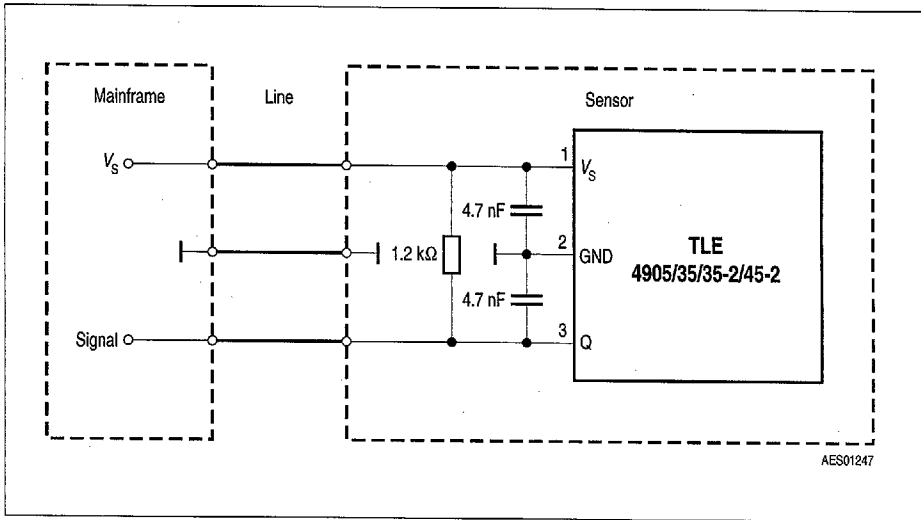
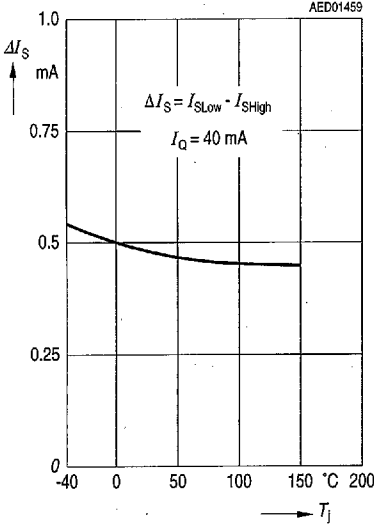

Figure 8 Application Circuit

■ 8235605 0134284 446 ■

If not otherwise specified, all curves reflect typical values at $T_j = 25^\circ\text{C}$ and $V_S = 12\text{ V}$.

Quiescent Current Difference versus Temperature



Saturation Voltage versus Output Current

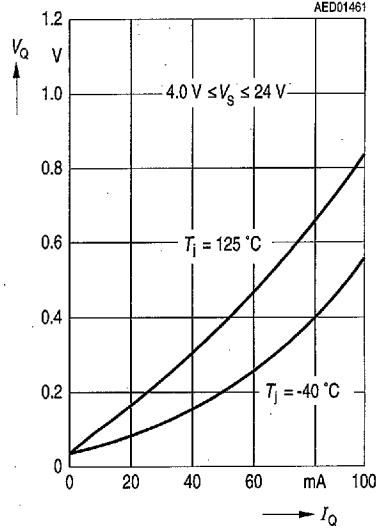

Quiescent Current versus Junction Temperature

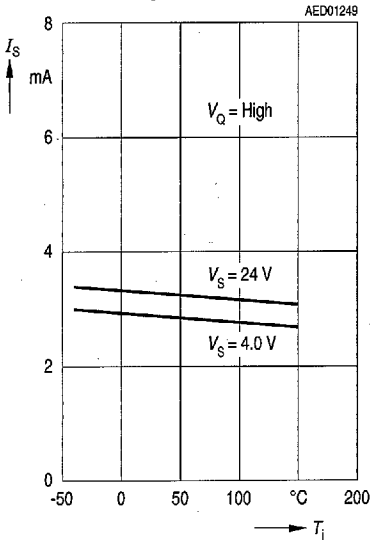

TLE 4905 Operate-and-Release-Point versus Junction Temperature

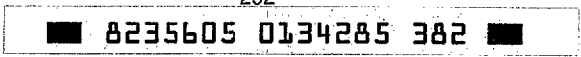
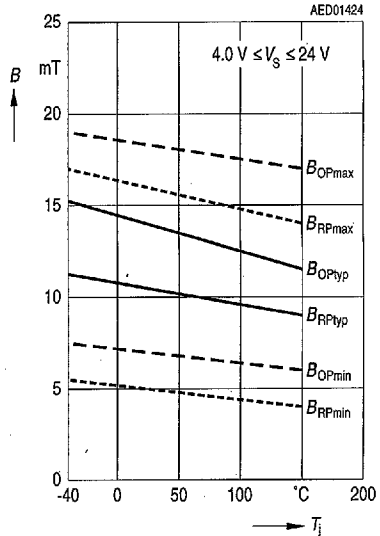

TLE 4935 Operate-and Release-Point versus Junction Temperature

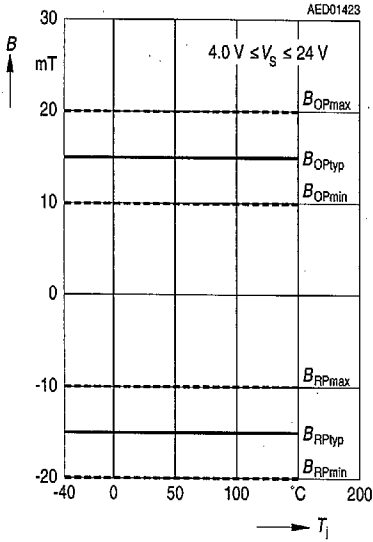

TLE 4935-2 Operate-and Release-Point versus Junction Temperature

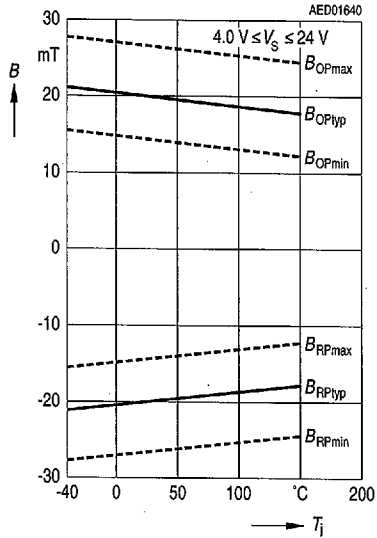

TLE 4905 Hysteresis versus Junction Temperature

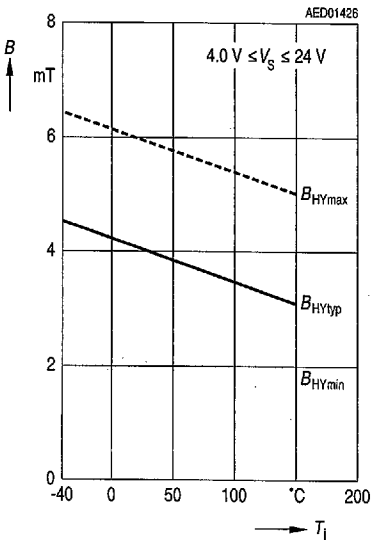

TLE 4945-2 Operate-and Release-Point versus Junction Temperature

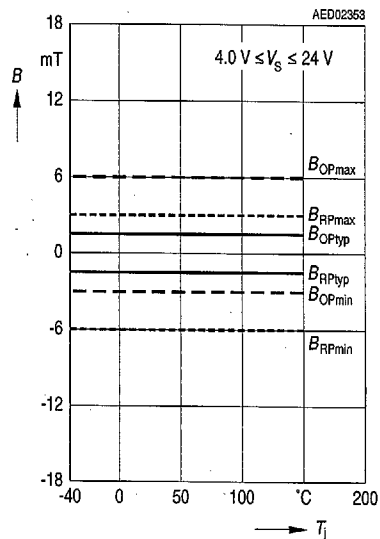

Package Outline

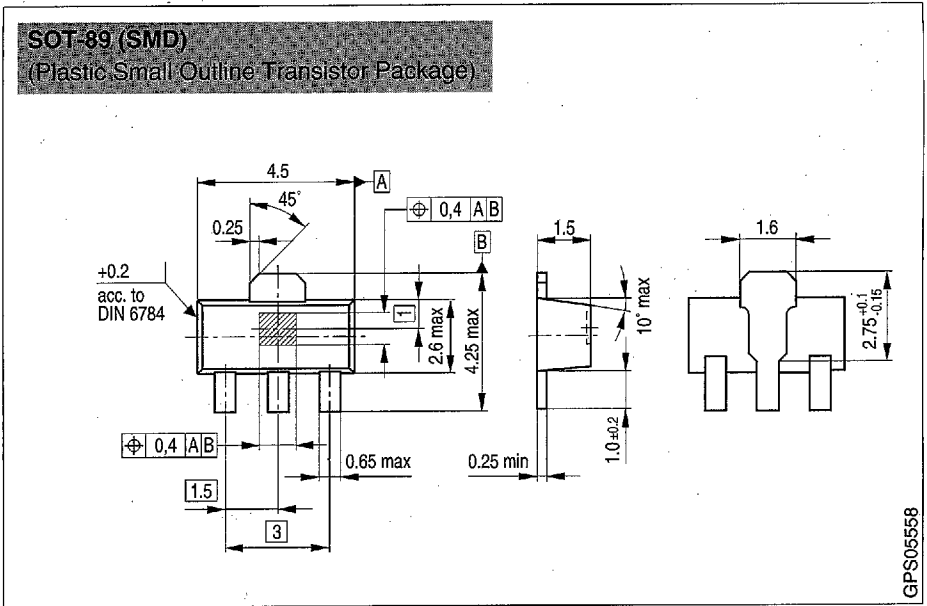

Package Information

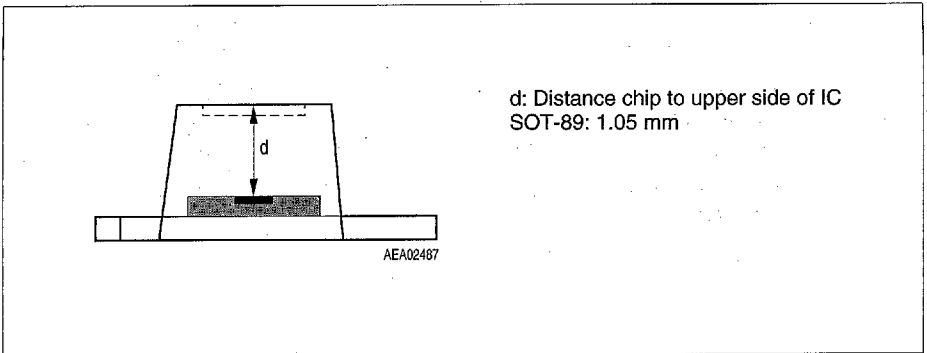

Sorts of Packing

Package outlines for tubes, trays etc. are contained in our Data Book "Package Information".

SMD = Surface Mounted Device

Dimensions in mm