

αGEL[®]
Discover Softness.

Alpha GEL

<http://www.taica.co.jp/gel-english/>

 **Taica Corporation**

Head office
Takanawa Sengakuji-ekimae Bldg. 3F, 2-18-10 Takanawa, Minato-ku, Tokyo 108-0074 Japan
Phone. +81-3-6367-6624 FAX. +81-3-6367-6620

Taica, **αGEL**, **optαGEL**, and the visual image of falling eggs are trademarks of Taica Corporation, registered in Japan, the United States and / or other countries.



 **Taica**

For human beings. For the earth. For the future.

*Living, working and
serving in harmony with the environment.*

*Identifying and tapping into possibilities in softness
— with multi-faceted proprietary αGEL technologies and beyond —
for increased well-being and comfort for people around the globe.
This is what Taica is all about.*

*Softness inherent to αGEL.
Softness is not just a catalyst for function or added comfort.
Softness embraces and protects our lives.
Softness is where we loosen up and feel relaxed.
Softness, flexibility and suppleness are the basis for that soothing
tenderness that brings us joy and happiness.
Representing these underlying core values, essential to lively well-being,
αGEL goes beyond mere functional material.*

*This understanding is at the heart of all we do,
as we listen to the varying and changing needs of the user,
and proactively and creatively continue to offer an
enhanced level of comfort.*

A raw egg dropped from a height of 18 m (60') — equivalent to the sixth floor of a building — remains unbroken when caught by a sheet of αGEL only 2 cm (0.8") thick.

αGEL is a silicone-based GEL.

Excellent Cushioning and Vibration Damping Performance

αGEL's (Alpha GEL) softness allows for deflection required for shock absorption and vibration damping, providing excellent cushioning and vibration damping performance.

Superior Durability

αGEL is highly resistant to ozone, UV rays and chemicals, making it possible to use in a variety of locations. In addition, its performance is maintained even after repeated compression.

Stable Performance Even In a Harsh Environment

αGEL's properties show little change in the -40°C (-40°F) to 200°C (392°F) range, providing stable performance.

Extremely High Safety

αGEL's composition makes it harmless to the human body and to the environment, causing no allergies when touched, and emitting no harmful gases when burned.

Outstanding Platform for Additional Functions and Enhanced Performance

On top of the unique combination of excellent features, αGEL also works as a reliable foundation for additional functions and for enhancing performance without compromising the merits softness brings.



Taica's Know-how

You can count on us for enhanced cushioning, vibration damping, tender feel, and more. Years of accumulated expertise and know-how, mastery of fine-tuning softness, designing and making optimum gel parts --- together all of these help cope with a variety of changing environments and needs of customers around the globe.

Shock Absorption

As proven through an egg-drop test in which a raw egg remains unbroken even when dropped from a height of 18m (about 60'), **αGEL** (Alpha GEL) has amazing shock absorbing capability. From sports to industrial applications, **αGEL** is the answer to various shock absorption needs.

◆ Shoe Cushioning

αGEL protects the knee from the impact of landing, said to be three times the weight of the body. Its performance remains stable even with vigorous movement during sports.



◆ Golf Iron

αGEL embedded in the high-rebound head of a golf iron absorbs excess force from the face of the head, allowing a soft, comfortable feeling of impact while providing distance of flight.

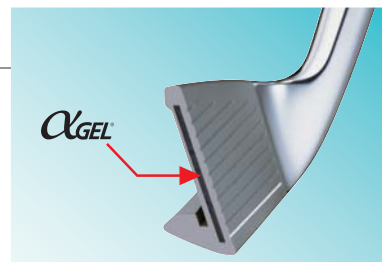

◆ Watch

αGEL protects precision electronic components in the watches from shock and vibration.



Courtesy of CASIO.COMPUTER CO.,LTD.

◆ Business Bag

αGEL in the laptop computer storage of the business bag keeps computers safe and secure.

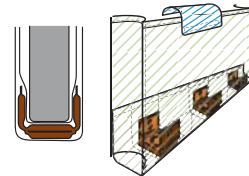

Courtesy of ACE Co.,LTD.

◆ Wheeled Luggage

Shock, vibration and noise can be reduced by installing **αGEL** between the luggage and wheel housing.



Courtesy of ACE Co.,LTD.

◆ Helmet Cushioning (NP GEL)

The addition of a foam GEL sheet only 3 mm thick effectively absorbs shock. This makes it possible to decrease the thickness of the helmet, making it lighter, and further extending the possibilities of design.



Vibration Damping

αGEL vibration insulators and bushes are ideal for light loads and microvibration. **αGEL**'s easy adjustability in shape and firmness makes vibration damping in wide frequency region from the low frequency, that had previously been very difficult, to the high frequency.

◆ Vacuum Pump and Compressor

αGEL vibration insulators can absorb low frequency vibration, which is difficult to be isolated by conventional dampers such as rubber.



◆ Railroad Signal

With a proven record of more than 10 years in the field, **αGEL** insulators protect the device from shock and vibration, often the causes of signal malfunction.

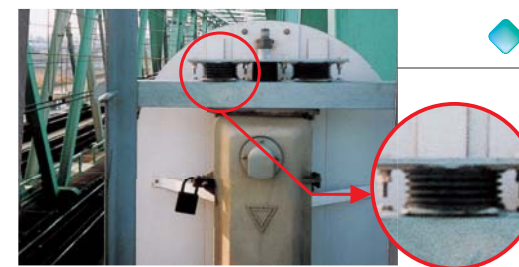

◆ PC Board

αGEL isolators are ideal primarily for light-load items such as PC boards. Its softness and mechanically reinforced strength allow for miniaturization of the final product and ensure long-term high performance.



◆ Laboratory and Medical Equipment

αGEL is used in laboratory and medical equipment such as centrifuge and oxygen condensers, for vibration damping with long term reliability.



◆ Drone

αGEL reduces vibration of cameras mounted on drones.



[Maximum Shock : Iron ball drop]

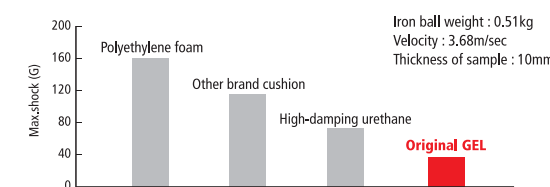

[Damping Characteristics]

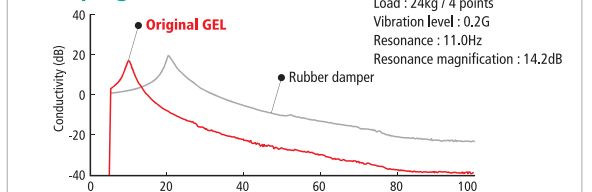

Soft & Smooth Feel/ Pressure Dispersion

α GEL (Alpha GEL) softly embraces and distributes pressure three-dimensionally, minimizing repercussion. Its inherent softness and flexibility allow a nice, smooth fit to the human skin and trigger a relaxing and even soothing feel, making α GEL more than just a functional material.

Reliable Platform for Additional Functions

With its natural softness and superior physical characteristics nearly intact, α GEL becomes a reliable, safe platform for various functions. The optimum solution is exemplified through a proven process including selecting fillers, fine-tuning softness to the needs of a customer, etc.

◆ Pen Grip

An α GEL grip provides a soothing, soft feel that gently fits any fingers. It helps decrease the chance of forming calluses, even when writing for a long time, making it a highly popular item.



◆ Supporting Breast Pad

α GEL's natural elasticity helps to fit elegantly to the body's lines. So light that it places no burden on the body, the pad can be worn without worry. Lightweight, safe and soft, the breast pad feels like part of the body.



◆ Bouldering Mat

α GEL layer enhances the impact absorbing characteristic and durability of the bouldering mat.

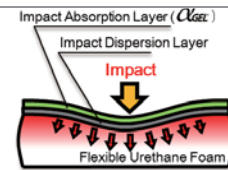

◆ Power Tool

α GEL installed grips on the power tools provide outstanding tactile impression and stable operability.



◆ Stroller Headrest

A foam GEL, safe for prolonged contact with skin, gently embraces the baby's head and effectively disperses the pressure on the head. Its shock absorbing capacity further increases safety.



◆ Bed Mattress

α GEL helps to effectively disperse body pressure and support a natural sleeping posture, providing a comfortable sleep.

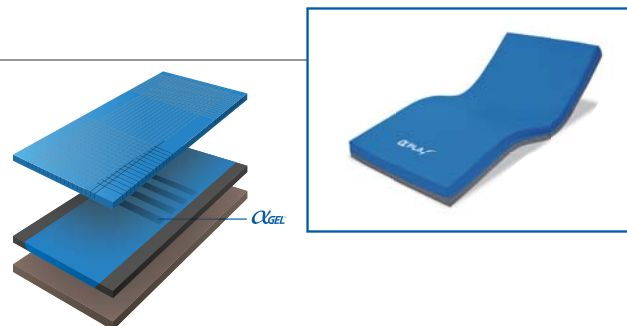

◆ IC/Semiconductor (Thermal Conductive GEL)

Soft thermal conductive GEL effectively transfers the heat generated from IC to heatsink, preventing malfunction of the PC and destruction of the devices. Soft thermal conductive paste/grease GEL is ideal for areas where sheet-type GEL is not applicable.

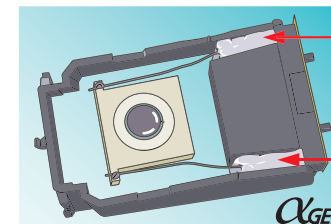
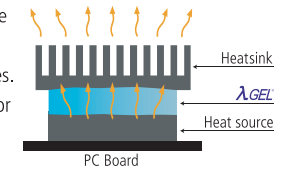

◆ Optical Pick-Up Device (UV Curing GEL)

UV Curing GEL is used mainly as damping material for optical pick up device. UV Curing GEL is supplied in liquid state.

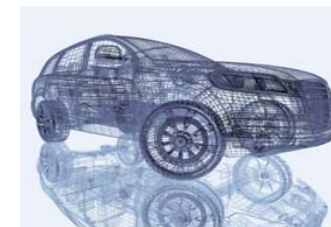

◆ On-board Electronics for Automotive

α GEL protects the ECU, which electronically controls the engine and electronic parts, from heat and shock.



◆ Smartphone/Tablet (UV Curing GEL)

CIPG (Cured-In Place Gasket) technology, the state-of-the-art gasketing solution using α GEL offers excellent waterproofing and dustproofing for smartphones and tablets.

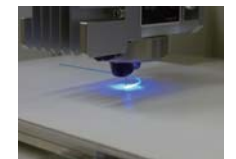

◆ Single-Lens Reflex Camera and Lens

α GEL provides multiple solutions to SLR Cameras and Lenses such as dampers for image stabilization, TIM (Thermal Interface Material) on electronics and shock absorbers for shutters.

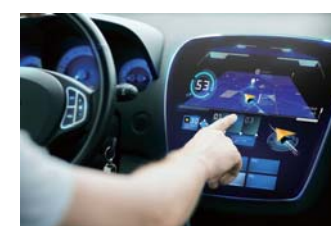

◆ Display (OPT α GEL)

Contrast and luminance of LCD displays are improved by OPT α GEL. It is also effective for shock resistance, stress release and parallax decrease.

Characteristics & Specs.

Standard Products

Shock absorption
Vibration damping
Soft & smooth feel
Additional functions
Characteristics & Specs.
Standard products

[Rebound Resilience]

ALGEL is temperature-independent when compared with other comparable materials.

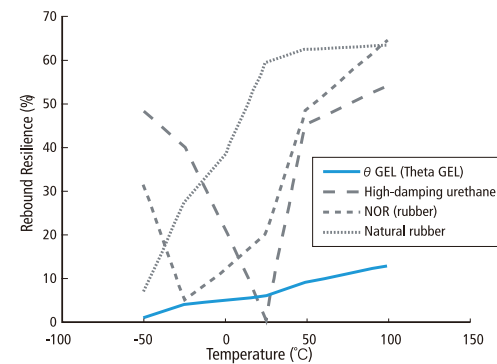

[Compression Set]

Even after prolonged compression, *ALGEL* returns to its original state.

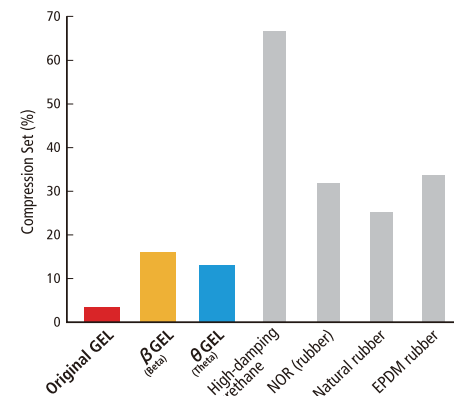

※Measurement (JIS K 6262)
① Compress by 25% and maintain for 22 hours at 70°C.
② Release compression and measure after 30 minutes at normal temperature.

[Physical Characteristics]

Item (unit)	Physical Value							Remark
	Original GEL	^(Beta) βGEL	^(Theta) θ-7	θ-5	θ-6	θ-8	NP GEL	
Appearance	Transparent	White	Translucent	Translucent	Translucent	Translucent	Green or White	
Specific Gravity	0.98	0.56	1.06	1.05	1.06	1.07	0.26	
Hardness	Needle penetration (1/10mm) ①	150	100	100	55	—	—	JIS K 2207
	Asker C ②	—	—	—	—	33	52.5	JIS K 7312
Tensile Strength (MPa)	0.03	0.14	0.23	1.17	1.58	2.35	0.32	JIS K 6251
Elongation (%)	340	220	480	710	480	300	73	JIS K 6251
Young's Modulus (kPa)	28.9	150.7	37.5	119.5	670.3	1432.6	269.5	
Specific Heat (J/g·K)	1.55	1.61	1.51	1.52	1.51	1.52	1.15	DSC
Thermal Conductivity (W/m·K)	0.18	0.10	0.20	0.20	0.20	0.20	0.06	③
Specific Volume Resistance Ratio (Ω·cm)	2.1×10 ¹⁴	3.7×10 ¹²	2.9×10 ¹⁴	4.0×10 ¹⁴	3.2×10 ¹⁴	6.6×10 ¹⁴	3.8×10 ¹⁴	JIS K 6911
Dielectric Breakdown Strength (kV/mm)	16.7	17.1	16.3	15.1	18.4	18.7	3.8	JIS C 2110
Chemical Resistance	Toluene	×	×	×	×	×	×	JIS K 6258 room temperature ×168h
	Acetone	×	×	×	×	×	×	
	Methanol	○	×	○	○	○	○	
	Distilled H ₂ O	○	○	○	○	○	○	
	Fuel Oil	×	×	×	×	×	×	
	Lubricant Oil	×	×	×	×	×	×	
	NaCl (10%)	○	○	○	○	○	○	
	HCl (10%)	○	○	○	○	○	○	
NaOH (5%)	○	○	○	○	○	○		
Normal Temperature Range (°C)	-40 ~ 200	-40 ~ 120	-40 ~ 200	-40 ~ 200	-40 ~ 200	-40 ~ 200	-40 ~ 200	
Normal Temperature Range (°F)	-40 ~ 392	-40 ~ 248	-40 ~ 392	-40 ~ 392	-40 ~ 392	-40 ~ 392	-40 ~ 392	

① Hardness is represented by the depth of the needle going into GEL. ② Rubber Hardness Meter. Hardness is represented by rebounding distance when the needle contacts GEL surface.
③ QTM 500 (KYOTO)
[Note]※ Silicone oil may bleed depending upon conditions .
※ Low molecular siloxane is included in this product which basically composed of silicone.
※ Above data are measured data, not guaranteed specifications.

Shock absorption
Vibration damping
Soft & smooth feel
Additional functions
Characteristics & Specs.
Standard products

Vibration Damping *Vibration Insulators*

Various insulators are available for loads from 2 (4.4 lb) to 300 kg (661.4 lb) with 4 points of support. Micro-vibrations as well as light-load vibration can be damped thanks to easily deflectable *ALGEL*.



Vibration Damping *GEL Bush*

Various bushes (or mounts) are available for tiny-to-small loads from 0.2 (0.44 lb) to 32 kg (70.55 lb) with 4 points of support. While small, they also excel in shock absorption and resistance to horizontal drift. Each bush should sandwich PCB and then be secured with a bolt.



Vibration Damping *SN Sheet*

Easy and simple to use. Place it under the device for instant and prolonged vibration damping. Addition and division of SN Sheets flexibly accommodates a wide range of load requirements.



Shock Absorption *Vibration Damping* *GEL Tape & GEL Chip*

ALGEL's softness and high performance are also readily applicable with an adhesive on one side in a variety of forms of tape or chip.



Shock Absorption *NP GEL*

Lightweight and flame retardant, NP GEL, soft foam *ALGEL*, is durable and weather resistant. Available for use in the -40°C (-40°F) to 200°C (392°F) range, it has low compression set.

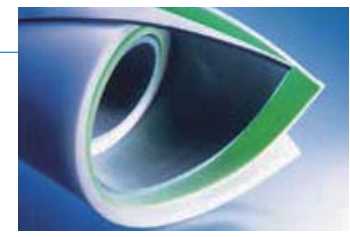

Reliable Platform for Additional Functions *λGEL (Lambda GEL)*

With its softness intact, *ALGEL* can be crafted to become thermal conductive, electromagnetic wave absorbent, electro conductive, etc. Soft, sticky and conformable, *ALGEL* often exhibits performance much better than published specifications due to close contact.



Vibration Insulators



- [Features]**
- Ideal for low frequency and micro vibration due to resonance point designed to be set low.
 - Wide selection to choose from: from 2 kg (4.4 lb) to 300 kg (661.4 lb).
 - Pick the best fit for your application based on the load (weight).
 - The published data are based on 4 points of support (usage).

Type θ

Part No.	Optimum Load (kg/4 points)	Resonance Point (Hz)	Resonance Magnification (dB)	Recommended Frequency (Hz)	h (mm)
θ-A	2.0 ~ 3.2	16 ~ 15	12	23 ~	13
θ-B	1.6 ~ 2.4	13 ~ 11	13 ~ 12	18 ~	18
θ-C	3.2 ~ 8.0	14 ~ 12	13 ~ 12	20 ~	18

Bolt material : Iron with trivalent chromate plating

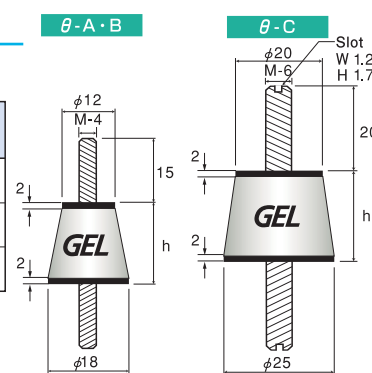

Type MN

Part No.	Optimum Load (kg/4 points)	Resonance Point (Hz)	Resonance Magnification (dB)	Recommended Frequency (Hz)
MN-3	8 ~ 14	12 ~ 10	12	17 ~
MN-5	14 ~ 22	11 ~ 10	14 ~ 13	16 ~
MN-7	22 ~ 34	11 ~ 10	16 ~ 15	16 ~
MN-10	34 ~ 50	11 ~ 10	20 ~ 18	16 ~

Bolt material : Iron with trivalent chromate plating

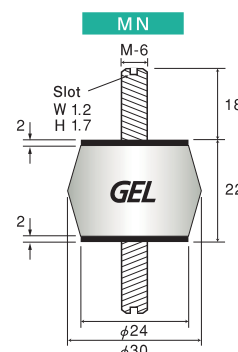

Type θ-TW

Part No.	Optimum Load (kg/4 points)	Resonance Point (Hz)	Resonance Magnification (dB)	Recommended Frequency (Hz)
θ-TW	50 ~ 100	10 ~ 8	20 ~ 19	14 ~

Bolt material : Iron with trivalent chromate plating

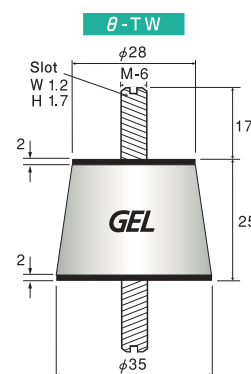

Type BG

Supported by a spring, type BG is effective for vertical vibration damping in particular.

Part No.	Optimum Load (kg/4 points)	Resonance Point (Hz)	Resonance Magnification (dB)	Recommended Frequency (Hz)	Bolt Diameter
BG-7	3.2 ~ 6.4	10 ~ 8	16 ~ 14	14 ~	M - 3
BG-8	6 ~ 16	10 ~ 8	18 ~ 16	14 ~	M - 6

Bolt material : Brass
Spring material : SWPA with trivalent chromate plating

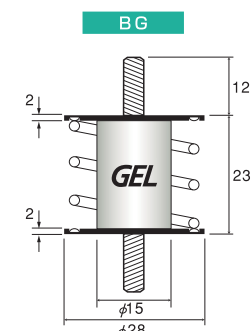

Type SF

For applications where a bottom plate is preferred instead of a bolt.

Part No.	Optimum Load (kg/4 points)	Resonance Point (Hz)	Resonance Magnification (dB)	Recommended Frequency (Hz)
SF-2	5 ~ 13	15 ~ 10	12 ~ 13	22 ~
SF-5	13 ~ 30	13 ~ 9	15 ~ 16	19 ~
SF-10	30 ~ 50	12 ~ 9	19 ~ 21	17 ~

Upper bolt material : Iron with trivalent chromate plating
Bottom plate material : SUS304

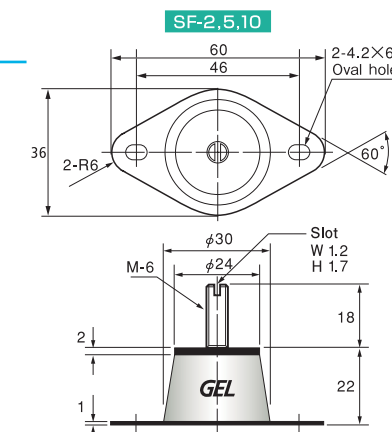

(Rubber-coated) Type SF

- For applications where a bottom plate is preferable and there is a need for damping heavy-load vibration.
- Good for outdoor use in particular due to reinforced durability deriving from *AGEL* wrapped by bellows-type EPDM rubber.
- Stable performance in the -20°C (-4°F) to 90°C (194°F) range.

Part No.	Optimum Load (kg/4 points)	Resonance Point (Hz)	Resonance Magnification (dB)	Recommended Frequency (Hz)
SF-30	100 ~ 140	8 ~ 9	18 ~ 19	13 ~
SF-50	120 ~ 300	10 ~ 15	12 ~ 18	15 ~

Metal parts have a choice between following 1. and 2.
1. Upper bolt / Bottom plate material : Iron with trivalent chromate plating
2. Upper bolt / Bottom plate material : SUS304

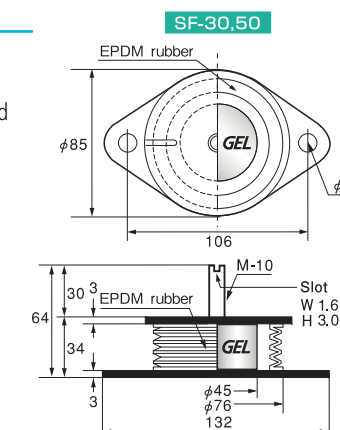

Installation

Always use in compression.

Correct Use

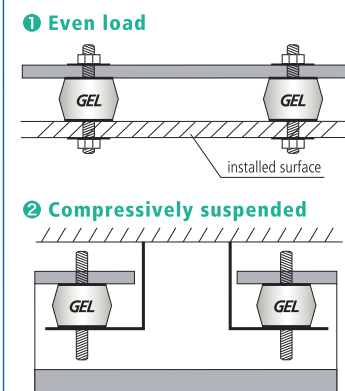

Incorrect Use

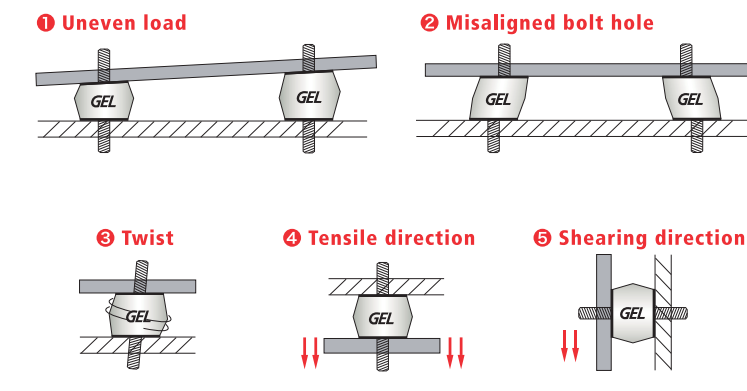

- ※ The height of the insulator may vary as the GEL is compressed under load.
- ※ The direction of the slot on the head of stud is not controlled.
- ※ Do not remove the GEL burr around the edge of metal. This could cause detachment of GEL from metal.

GEL Bush



- [Features]** · Designed to damp tiny-to-light-load and micro vibration.
- Effective for minimizing horizontal drift, using a bolt running through GEL Bush.
 - Along with its shock absorbing capability, GEL Bush is ideal for light and fragile objects including PCBs (printed circuit boards).
 - Available for loads from 0.2 kg (0.44 lb) to 32 kg (70.55 lb) with 4 points of support.

Type A

Part No.	Optimum Load (kg/4 points)	Resonance Point (Hz)	Resonance Magnification (dB)	Recommended Frequency (Hz)
A-1	0.5 ~ 2.5	67 ~ 35	9 ~ 10	0.5kg : 95 ~ 2.5kg : 50 ~
A-2	2.5 ~ 4.0	49 ~ 37	15 ~ 16	2.5kg : 70 ~ 4.0kg : 55 ~

Collar material : Brass

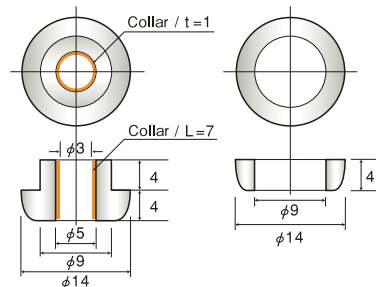

Type B

Part No.	Optimum Load (kg/4 points)	Resonance Point (Hz)	Resonance Magnification (dB)	Recommended Frequency (Hz)
B-1	4 ~ 15	49 ~ 23	15 ~ 17	4kg : 70 ~ 15kg : 35 ~
B-2	15 ~ 32	38 ~ 20	19 ~ 23	15kg : 40 ~ 32kg : 25 ~

Collar material : Brass

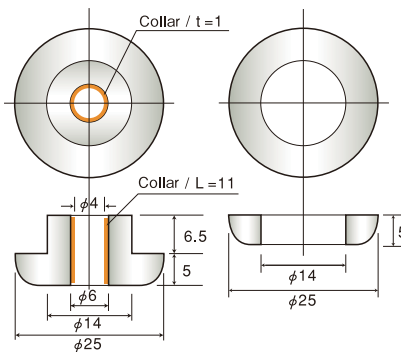

Type S

Part No.	Optimum Load (kg/4 points)	Resonance Point (Hz)	Resonance Magnification (dB)	Recommended Frequency (Hz)
S	0.2 ~ 0.75	64 ~ 42	7 ~ 9	0.2kg : 90 ~ 0.75kg : 60 ~

Collar material : Brass

※ These data were obtained with 1.2mm -thick PCB sandwiched for type A, 1.5mm for type B, and 1.0mm for type S.
 ※ Recommended frequency depends on loads.
 ※ Since this product is very soft and easily damaged, please handle with care.

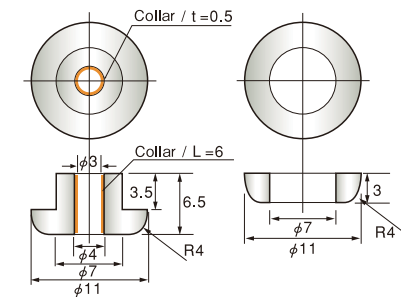

- [Notes]** · Tighten the bolt all the way to the collar.
- Usable bolts are M3 or smaller for type A, M4 or smaller for type B, and M3 or smaller for type S.
 - Use a washer equal to or bigger than the diameter of the upper portion of GEL Bush.
- ※ Collar inside the GEL Bush can be removed for use.

[Installation]

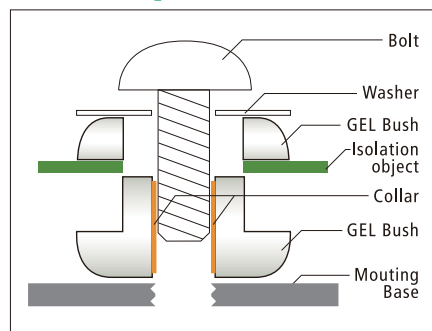

[Damping Characteristics]

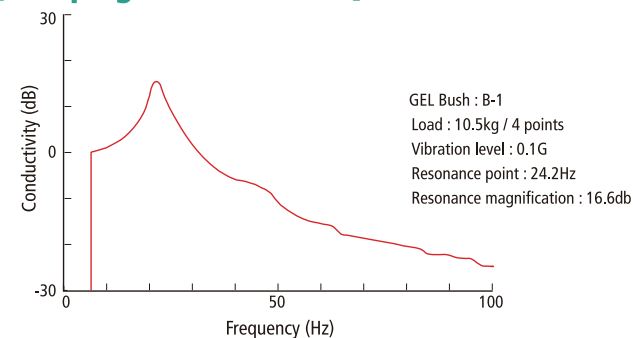

SN Sheet



- [Features]** · Add more or divide SN Sheet flexibly for a wide range of load requirements.
- Just place it under the device. Removable anytime.
 - Stable with small resonance magnification and little horizontal distortion.

Part No.	Optimum Load (kg/1 Sheet)	Resonance Point (Hz)	Resonance Magnification (dB)	Recommended Frequency (Hz)	Deflection (mm)	Color
SN-2	0.5 ~ 2	27 ~ 21	6	38 ~	1.4 ~ 3.0	yellow
SN-5	2 ~ 5	29 ~ 23	8	40 ~	1.5 ~ 2.5	green
SN-15	5 ~ 15	26 ~ 18	13	37 ~	1.1 ~ 2.2	orange
SN-50	15 ~ 50	22 ~ 15	20 ~ 18	30 ~	0.7 ~ 2.0	blue

- [Notes]** · Place SN Sheet (or portions of them) so that the vibrating object becomes stable.
- Place SN Sheet so that the load of the vibrating object is spread evenly on the projections.
 - Placing a flat plate on the top surface of SN Sheet helps.
 - Remove the protective PET film from the bottom face before use.

[Damping Characteristics]

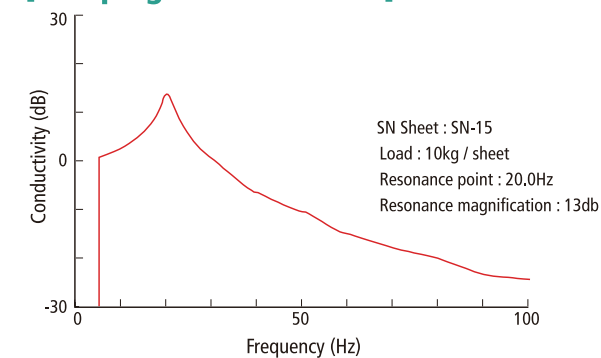

[Installation]

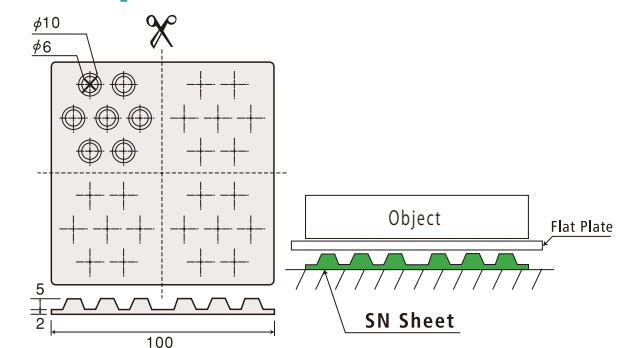

- Application guideline:**
- For 0.3 kg load, add a plate to exceed 0.5 kg or use at least three squares of the divided SN-2.
 - For 10 kg load, use a sheet of SN-15 as it is or at least three squares of the divided SN-15.
 - For 80 kg load, use 2 sheets of SN-50.

Terminology

Optimum Load

Each of our vibration damping products is designed to work best for a certain range of weight (optimum load). Select the best one based on the load of the vibrating object. Optimum load assumes 4 points of support (one sheet for SN Sheet).

Resonance Point (Hz)

Resonance point is the frequency at which the object reaches maximum vibration when it is externally vibrated on a vibration damping product. Resonance point is determined by the spring constant of the vibration damping products and the weight of the vibrating object.

Resonance Magnification (dB)

Resonance magnification is the ratio, at resonance point, of the vibration amplitude with the vibration damping products to that without them. The vibrating object will vibrate at about twice the amplitude at 6dB, at about five times at 14dB, and at about ten times at 20dB, compared to when no vibration damping products are used.

Recommended Frequency (Hz)

For effective vibration damping, the frequency of the vibrating object needs to be at least $\sqrt{2}$ the resonance point. Recommended frequency is defined as the range above this frequency. Select the best one based on the frequency of the vibrating object.

GEL Tape & GEL Chip



λGEL (Lambda GEL)



- [Features]**
- Simple and easy solution for vibration isolation and shock absorption with adhesive on one side.
 - Wide selection to choose from based on width and thickness.
 - Very easy and effective solution for shock absorption and vibration damping where no space is allowed for insulators or bushes.
 - Wide temperature range from -40°C (-40°F) to 100°C (212°F).

- [Features]**
- λGEL (Lambda GEL) is αGEL-based functional material for thermal conductivity, electromagnetic absorption and electric insulation.
 - Soft, sticky and conformable, λGEL often exhibits performance much better than published specifications due to close contact.

GEL Tape

Item	W (mm) × L (mm) × T (mm)
GT-1	10 × 1,000 × 1
GT-2	20 × 1,000 × 1
GT-3	10 × 1,000 × 2
GT-4	20 × 1,000 × 2
GT-5	10 × 1,000 × 3
GT-6	20 × 1,000 × 3

※ Custom size could be available.

GEL Chip

Item	W (mm) × L (mm) × T (mm)
GC-1	10 × 10 × 3
GC-2	10 × 10 × 5
GC-3	15 × 15 × 3
GC-4	15 × 15 × 5
GC-5	15 × 15 × 10
GC-6	20 × 20 × 3
GC-7	20 × 20 × 5
GC-8	20 × 20 × 10

※ Each item is delivered in min. 25 pcs / sheet.

- [Notes]**
- Before use, remove dust from the object.
 - Attach with even pressure after removing the separation liner paper.
 - Apply sufficient pressure to securely attach PSA (pressure-sensitive adhesive).
 - Powder is applied to the surface of GEL.

- [COH series] Sheet-type thermal conductive GEL
- [DP series] Paste-type thermal conductive GEL
- [RE series] Sheet-type thermal conductive + electromagnetic absorbent GEL

Refer to the separate brochures for details of the λGEL series.

[Thermal Conductivity and Flexibility]

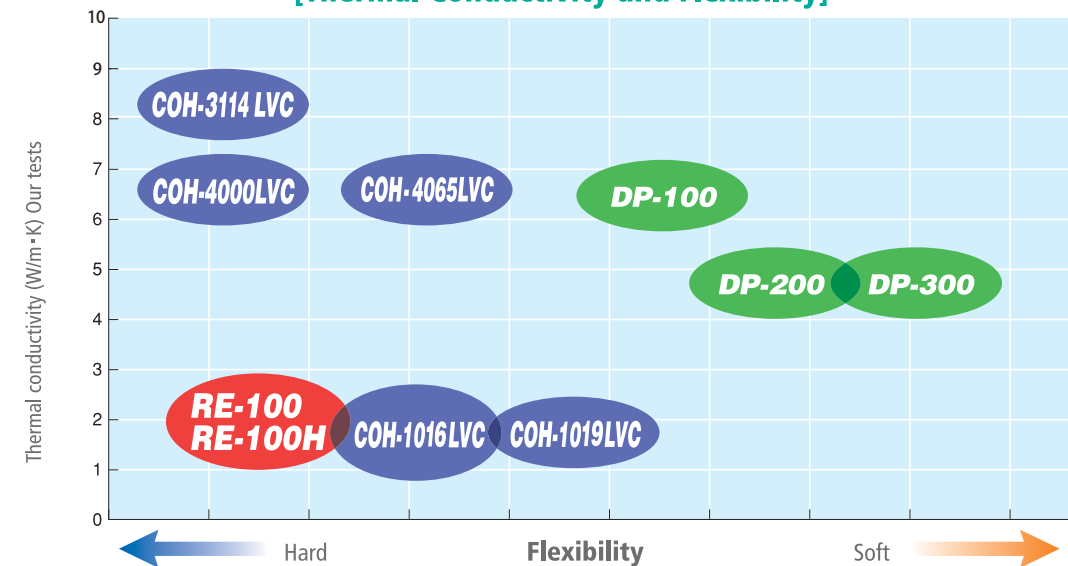

Sheet-type



Paste-type



[Frequency Range]

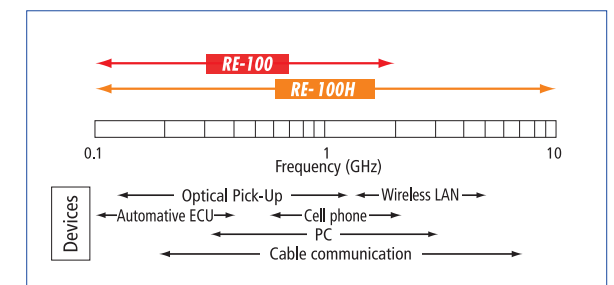

[Note] Under certain conditions such as hard-pressed use, silicone oil may bleed.

[Notes]

- To the best of our knowledge, the information and statements on this brochure are believed to be true and reliable; however, the PRODUCTS described herein are sold WITHOUT ANY GUARANTEE OR WARRANTY INCLUDING THE IMPLIED WARRANTIES OF MERCHANTABILITY AND FITNESS FOR PARTICULAR PURPOSES since the application and conditions of each use vary and change, and are beyond the control of manufacturer and seller(s). The customers and users of the PRODUCTS shall assume the responsibility for determining the suitability of the PRODUCTS based on their tests and for whatever risks and liability associated with the use of the PRODUCTS. NEITHER MANUFACTURER NOR SELLER(S) SHALL BE LIABLE EITHER IN TORT OR CONTRACT OR ANY OTHER CAUSE FOR ANY KIND OF LOSS OF PROFITS OR DAMAGE, INCIDENTAL, DIRECT, OR CONSEQUENTIAL, ARISING OUT OF OR IN CONNECTION WITH THE USE OF OR THE INABILITY TO USE THE PRODUCTS.
- It is highly recommended that users would not use the products shown in the brochure in medical applications, particularly for implantation use.
- The users shall be aware of the fact that silicone oil could bleed from alpha-gel. It is therefore that any user should be responsible for conducting reliability test in advance before delivering the products in the market.
- The Silione-gel contains low molecular siloxane, which could be volatile.
- The powder is applied on the surface of the GEL to reduce the tackiness temporarily and does not guarantee its effect.

* The copyright of this brochure belongs to Taica Corporation. It is prohibited to copy and to use the contents of this brochure without our prior consent.

NP GEL



- [Features]**
- Lightweight and highly durable foamed type.
 - With low compression set, performance of NP GEL is maintained even after repeated compression.
 - Highly flame retardant and operable in the -40°C (-40°F) to 200°C (392°F) range.
 - Good for outdoor use because it is highly resistant to weather and ozone.

[Compression Set]

Item	W (mm) × L (mm) × T (mm)
Green	450 × 2,000 × 3
White	300 × 1,000 × 6

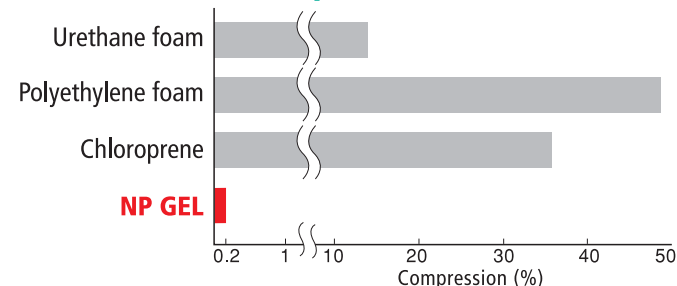

※ Measurement (JIS K 6401)
 ① Compress by 50% and maintain for 22 hours at 70°C.
 ② Release compression and measure after 30 minutes at normal temperature.

[Note]

- Powder is applied to the surface for 3mm thick.