

LT3935

36V, 4A Synchronous Buck LED Driver with Silent Switcher

DESCRIPTION

Demonstration circuit 2987A is a 36V, 4A synchronous 2MHz buck LED driver featuring the **LT[®]3935**. This demonstration circuit powers one or two LEDs at 4A. DC2987A runs from an input voltage of 8V to 36V as built and can run down to $3.6V_{IN}$ if UVLO is adjusted. It runs at 2MHz switching frequency. With Spread Spectrum Frequency Modulation (SSFM) turned on, it runs from 2MHz to 2.5MHz. An optional low-side NMOS PWM dimming MOSFET can be used for a high PWM dimming ratio. DC2987A features undervoltage lockout (UVLO) set at 7V with 0.7V hysteresis for turn-on. This Silent Switcher[®] demo circuit features low emissions.

The LT3935 has an input voltage range from 3.6V to 36V. It has internal, synchronous 5.8A, 40V switches for high power, and high efficiency with a single IC. It has an adjustable switching frequency between 200kHz and 2MHz. It can be synchronized (SYNC) to an external source or run with SSFM for low EMI.

The LT3935 can be PWM dimmed for accurate brightness control. An optional low-side MOSFET can be driven from the PWM input source for high and accurate dimming ratio. However, LED⁻ can be connected directly to GND

for the least components. In this arrangement, PWM dimming has less range. Analog dimming is accomplished by driving the CTRL pin with a voltage below 1.5V to lower the LED sense voltage.

Small ceramic input and output capacitors save space and cost. The open LED overvoltage protection uses the IC's constant-voltage regulation loop to regulate the output to approximately 9V if the LED string is opened. Then a fault flag is asserted. The output current can be monitored through the ISMON output pin.

The UVLO voltage, LED current, output voltage range, switching frequency, brightness control, and SSFM can all be adjusted with simple modifications to the demo circuit.

The LT3935 data sheet gives a complete description of the device, operation and applications information. The data sheet must be read in conjunction with this demo manual for DC2987A. The LT3935JV is assembled in a 28-lead 5mm × 4mm LQFN package with a thermally enhanced GND.

[Design files for this circuit board are available.](#)

All registered trademarks and trademarks are the property of their respective owners.

PERFORMANCE SUMMARY Specifications are at T_A = 25°C

PARAMETER	CONDITION	MIN	TYP	MAX	UNIT
Input Voltage V _{IN} Range	Operating I _{LED}	8		36	V
V _{IN} Undervoltage Lockout (UVLO) Falling	Operating V _{LED} = 7.2V I _{LED} = 4A		7.0		V
V _{IN} Enable Turn-On (EN) Rising			7.7		V
Safe Input Voltage V _{IN} Range		0		36	V
Switching Frequency (f _{sw})	R5 = 45.3kΩ, SSFM = OFF R5 = 45.3kΩ, SSFM = ON		2.0 2.0 – 2.5		MHz MHz
LED Current I _{LED}	R1 = 25mΩ, 8V < V _{IN} < 36V, V _{LED} = 7.2V, V _{CTRL} = 2V		4.0		A
LED Voltage V _{LED} Range	R7 = 1MΩ, R8 = 124kΩ	2.4		8.0V	V
Open LED Voltage V _{OUT}	R7 = 1MΩ, R8 = 124kΩ		9.0V		V
Efficiency (100% PWM DC)	12V V _{IN} , 2MHz, 2 LEDs, SSFM = OFF		91%		%

BOARD PHOTO

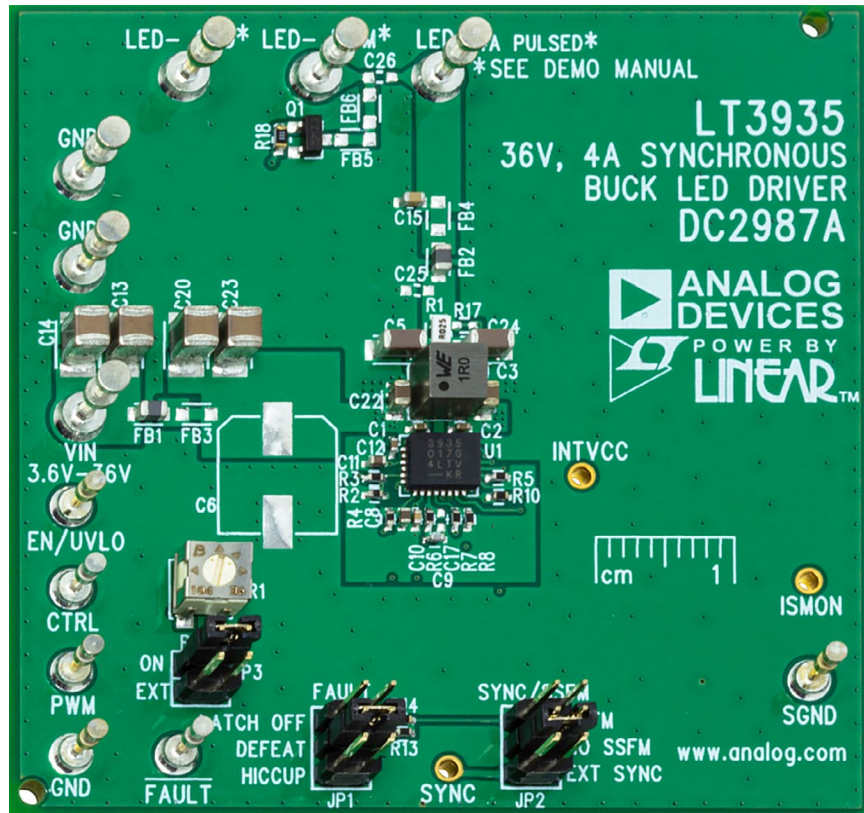

Figure 1. DC2987A Board Photo

QUICK START PROCEDURE

NOTE: Make sure that the voltage applied to V_{IN} does not exceed 36V.

The DC2987A is easy to set up to evaluate the performance of the LT3935. Refer to Figure 1 for proper measurement equipment setup and follow the procedure below.

1. With power off, connect a string of one or two LEDs that runs with a forward voltage less than or equal to 8V at 4A to the LED⁺ and LED⁻ GND terminals.
2. Connect the EN/UVLO terminal to GND.
3. For always-on LED operation: Set JP3 to ON.
4. With power off, connect the input power supply to the V_{IN} and GND terminals.
5. Turn the input power supply on and make sure the voltage is between 8V and 36V to start operation.
6. Release the EN/UVLO-to-GND connection.
7. Observe the LED string running at the programmed LED current.
8. To change the brightness with analog dimming, simply adjust the VR1 potentiometer or attach a voltage source to the CTRL terminal and set the voltage between 0V and 2V. See data sheet for details.
9. To change brightness with external PWM dimming, set JP3 to EXT. Connect LEDs between LED⁺ and LED⁻ PWM terminals. Keep LED wire length to a minimum to achieve higher dimming ratios. Attach a 0V to 3V rectangular waveform with varying duty cycle to the PWM terminal.
10. To enable spread spectrum frequency modulation, set JP2 to SSFM

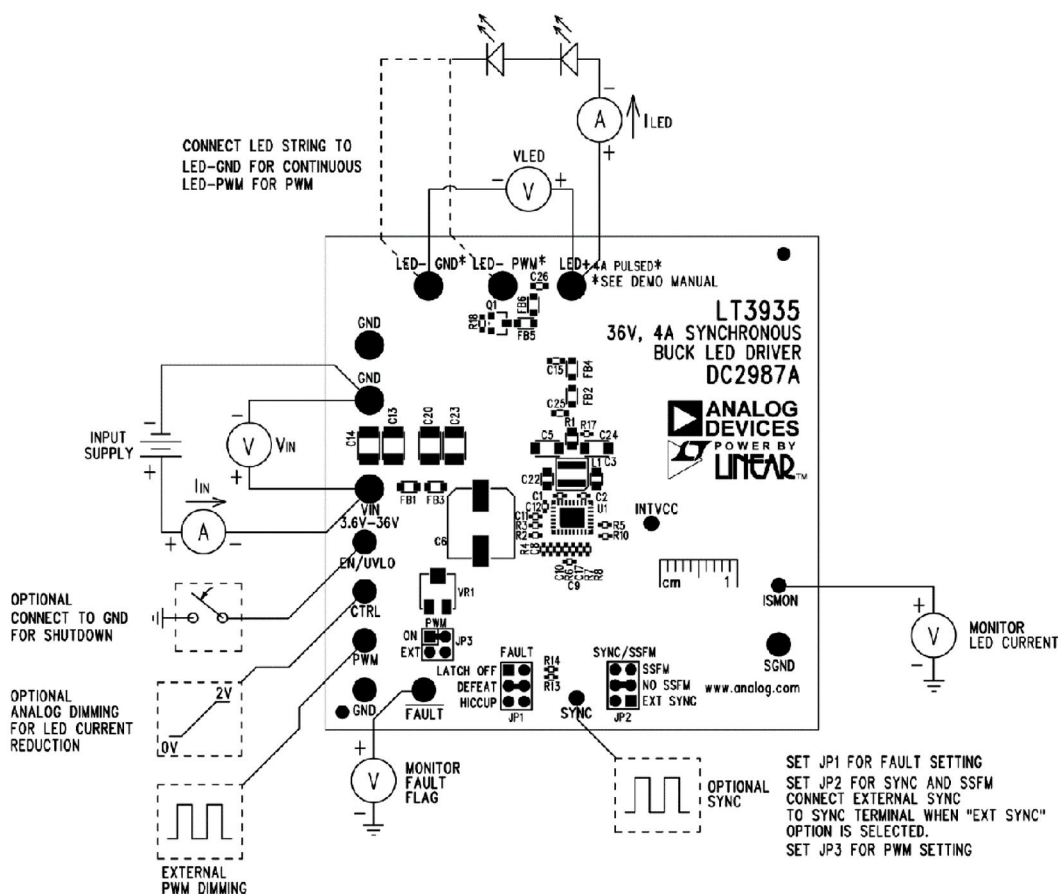

Figure 2. Test Procedure Setup Drawing for DC2987A

TEST RESULTS

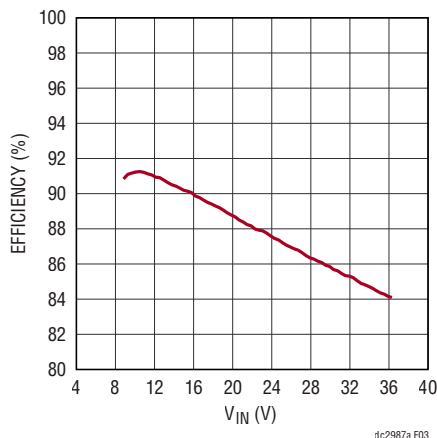

Figure 3. DC2987A Efficiency vs Input Voltage with 2MHz and 2 LEDs at 7.4V_{LED} 4A with SSFM Off

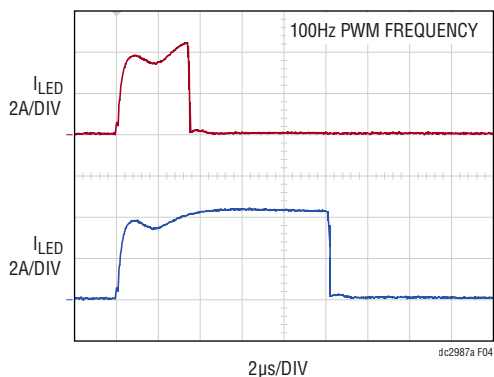

Figure 4. DC2987A High Performance External PWM Dimming with LEDs Connected Between LED⁺ and LED⁻ PWM with SSFM Off, 12V_{IN} and 7.4V_{LED}

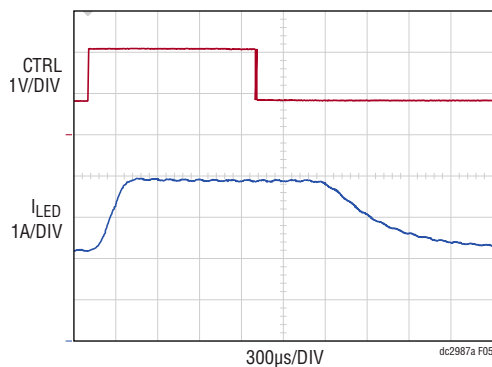
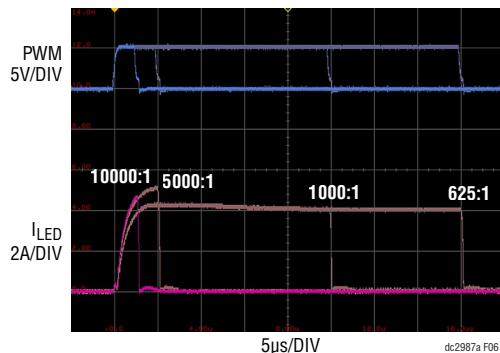

Figure 5. DC2987A 50% to 100% I_{LED} Load Transient with CTRL Input with SSFM Off, 12V_{IN} and 7.4V_{LED}



V_{IN} = 12V, V_{LED} = 7.4V, I_{LED} = 4A
 f_{SW} = 2MHz + SSFM ON
 100Hz EXTERNAL PWM DIMMING
 WIRE LENGTH OF 15cm BETWEEN LED⁺ AND LED⁻ PWM

Figure 6. The LT3935 Can Achieve Dimming Ratios of 10000:1 at 100Hz

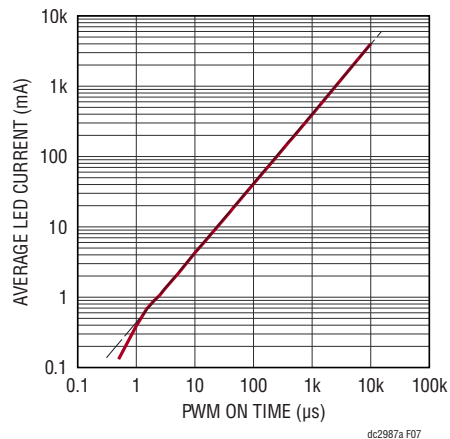
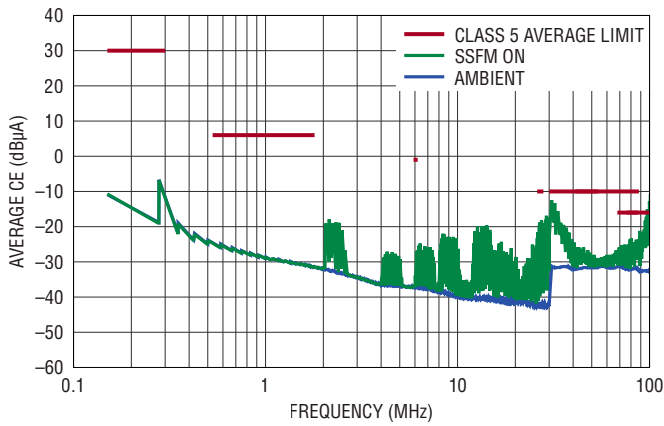
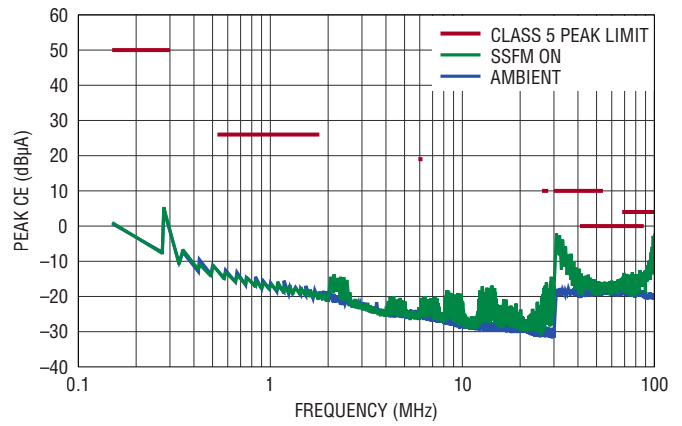

Figure 7. PWM Dimming Has Linear Behavior at High Dimming Ratios. Connect LED String to LED⁺ and LED⁻ PWM to Use the MOSFET for Highest Dimming Ratio

EMISSION RESULTS



dc2987a F08a



dc2987a F08b

Figure 8. Average and Peak Conducted Emissions Performance Using Current Method with CISPR25 Class 5 Limits

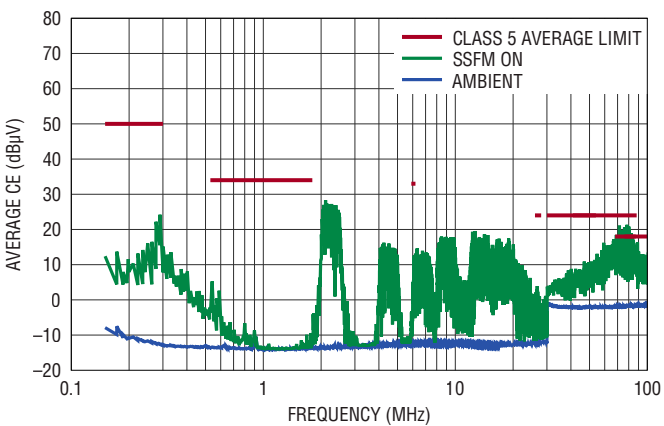

dc2987a F09a

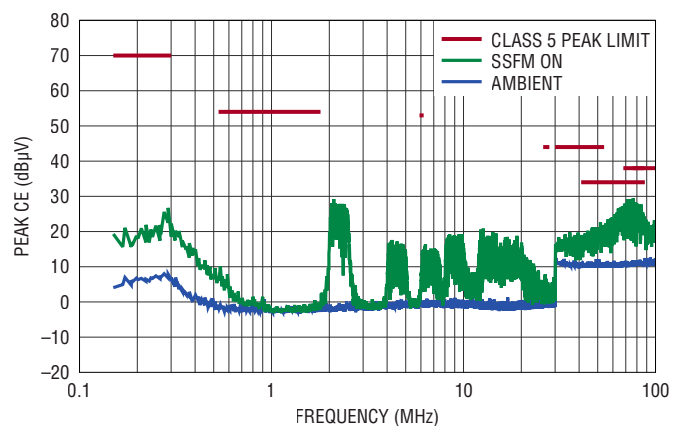

dc2987a F09b

Figure 9. Average and Peak Conducted Emissions Performance Using Voltage Method with CISPR25 Class 5 Limits

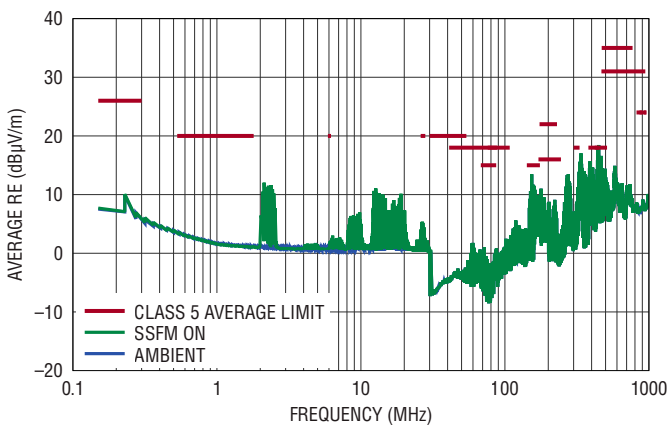

dc2987a F10a

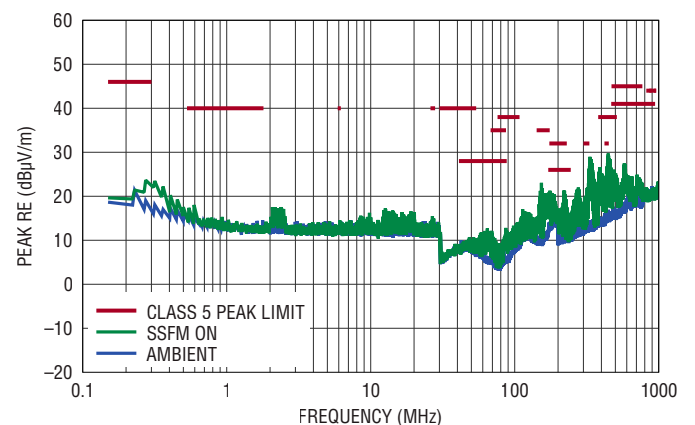

dc2987a F10b

Figure 10. Average and Peak Radiated Emissions Performance with CISPR25 Class 5 Limits

DEMO MANUAL DC2987A

PARTS LIST

ITEM	QTY	REFERENCE	PART DESCRIPTION	MANUFACTURER/PART NUMBER
Required Circuit Components				
1	2	C1, C2	CAP., X7R, 0.1 μ F, 50V, 10% 0402, AEC-Q200	MURATA, GCM155R71H104KE02D
2	2	C3, C22	CAP., X7R, 1 μ F, 50V, 10% 0805, AEC-Q200	MURATA, GCM21BR71H105KA03L
3	2	C5, C24	CAP., X7R, 6.8 μ F, 16V, 10% 1206, AEC-Q200	TDK, CGA5L1X7R1C685K160AC
4	2	C8, C11	CAP., X5R, 2.2 μ F, 25V, 10% 0402, AEC-Q200	MURATA, GRT155R61E225KE13D
5	1	C9	CAP., COG/NPO, 150pF, 25V, 5% 0402	AVX, 04023A151JAT2A
6	1	C10	CAP., X7R, 1000pF, 25V, 10% 0402	AVX, 04023C102KAT2A
7	1	C12	CAP., X7R, 0.1 μ F, 16V, 10% 0402	AVX, 0402YC104KAT2A
8	1	C15	CAP., X7R, 0.01 μ F, 16V, 10% 0603	AVX, 0603YC103KAT2A
9	1	L1	IND., 1 μ H	WURTH ELEKTRONIK, 74438357010
10	1	R1	RES., 0.025 Ω , 1/2W, 1% 0805, AEC-Q-200	SUSUMU, KRL1220E-M-R025-F-T1
11	1	R5	RES., 45.3k, 1/16W, 1% 0402, AEC-Q200	VISHAY, CRCW040245K3FKED
12	1	R6	RES., 10k, 1/16W, 1% 0402, AEC-Q200	VISHAY, CRCW040210K0FKED
13	1	R7	RES., 1M, 1/16W, 1% 0402, AEC-Q200	VISHAY, CRCW04021M00FKED
14	1	R8	RES., 124k, 1/16W, 1% 0402, AEC-Q200	VISHAY, CRCW0402124KFKED
15	1	U1	IC., LT3935, LQFN-28, 5mm \times 4mm	ANALOG DEVICES, LT3935JV#PBF
Additional Demo Circuit Components				
16	0	C6	CAP., OPTION, ALUM. ELECT., SMD	
17	4	C13, C14, C20, C23	CAP., X7S, 10 μ F, 50V, 10% 1210, AEC-Q200	MURATA, GCM32EC71H106KA03L
18	0	C17	CAP., OPTION, 0402	
19	0	C25, C26	CAP., OPTION, 0603	
20	2	FB1, FB2	FERRITE BEAD, 120 Ω , 0805	MURATA, BLM21PG121SH1D
21	0	FB3, FB4, FB5, FB6	FERRITE BEAD, OPTION, 0805	
22	1	Q1	XSTR., MOSFET, N-CH, 20V, 4.7A, SOT23-3	NEXPERIA, PMV28UNEAR
23	2	R2, R4	RES., 34k, 1/16W, 1% 0402	BOURNS, CR0402-FX-3402GLF
24	1	R3	RES., 169k, 1/16W, 1% 0402, AEC-Q200	VISHAY, CRCW0402169KFKED
25	1	R13	RES., 1M Ω , 1/16W, 1% 0402, AEC-Q200	VISHAY, CRCW04021M00FKED
26	1	R10	RES., 100k, 1/16W, 5% 0402, AEC-Q200	VISHAY, CRCW0402100KJNED
27	1	R14	RES., 2M, 1/16W, 1% 0402, AEC-Q200	VISHAY, CRCW04022M00FKED
28	0	R17	RES., OPTION, 0402	
29	1	R18	RES., 0 Ω , 1/10W, 0603, AEC-Q200	VISHAY, CRCW06030000Z0EA
30	1	VR1	TRIMMER 100k 0.25W SMD	BOURNS, 3314J-1-104E
Hardware: For Demo Circuit Only				
31	6	E1, E2, E10, E11, E13, E15	TESTPOINT, TURRET, 0.094" PBF	MILL-MAX, 2501-2-00-80-00-00-07-0
32	6	E3, E4, E6, E7, E12, E14	TESTPOINT, TURRET, 0.061" PBF	MILL-MAX, 2308-2-00-80-00-00-07-0
33	2	JP1, JP2	HEADER 3 PIN 0.079 DOUBLE ROW	WURTH ELEKTRONIK, 62000621121
34	1	JP3	HEADER 2 PIN 0.079 DOUBLE ROW	SULLINS CONNECTOR SOLUTIONS, NRPNO22PAEN-RC
35	3	XJP1, XJP3, XJP6	SHUNT, .079" CENTER	WURTH ELEKTRONIK, 60800213421

SCHEMATIC DIAGRAM

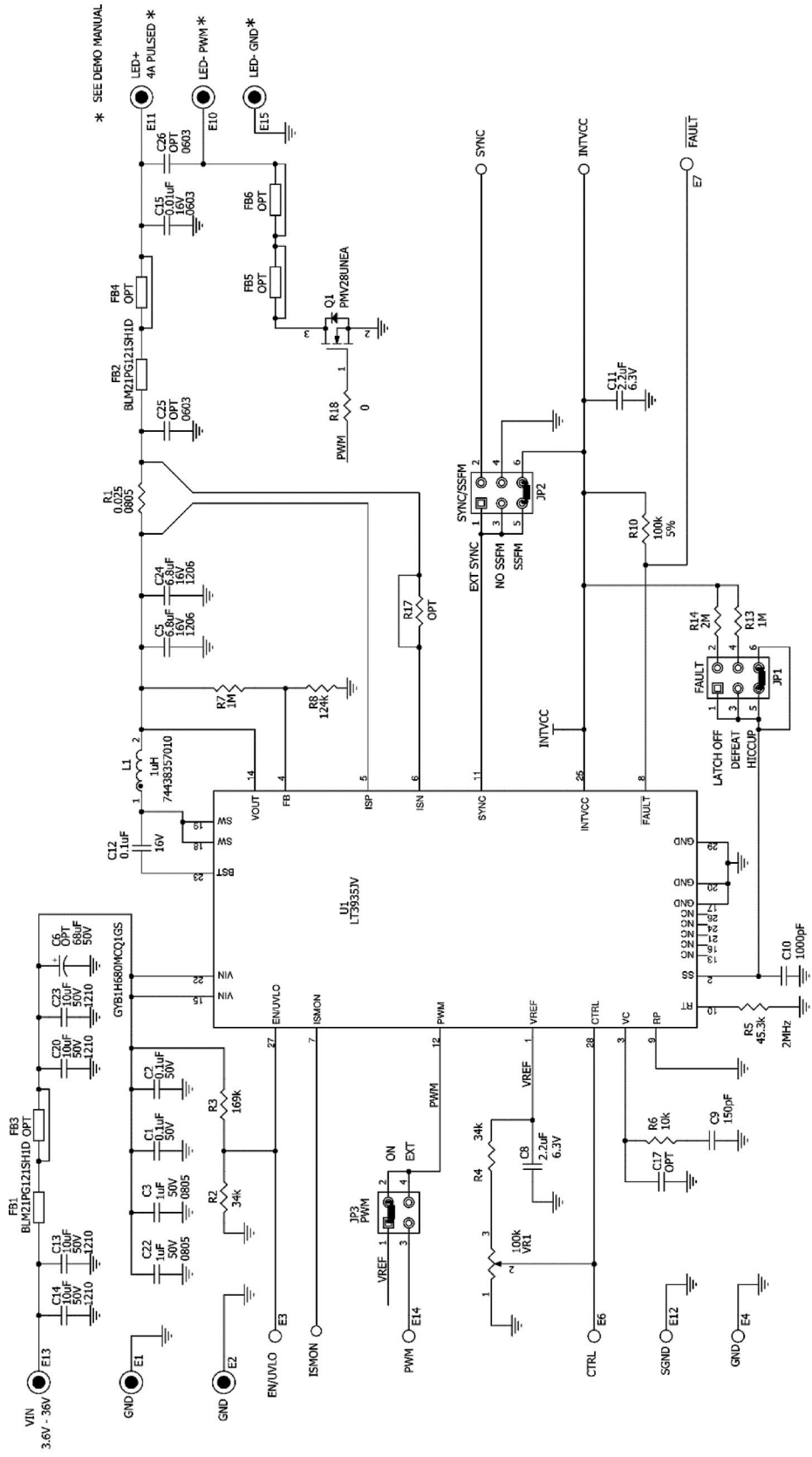

* SEE DEMO MANUAL



ESD Caution

ESD (electrostatic discharge) sensitive device. Charged devices and circuit boards can discharge without detection. Although this product features patented or proprietary protection circuitry, damage may occur on devices subjected to high energy ESD. Therefore, proper ESD precautions should be taken to avoid performance degradation or loss of functionality.

Legal Terms and Conditions

By using the evaluation board discussed herein (together with any tools, components documentation or support materials, the "Evaluation Board"), you are agreeing to be bound by the terms and conditions set forth below ("Agreement") unless you have purchased the Evaluation Board, in which case the Analog Devices Standard Terms and Conditions of Sale shall govern. Do not use the Evaluation Board until you have read and agreed to the Agreement. Your use of the Evaluation Board shall signify your acceptance of the Agreement. This Agreement is made by and between you ("Customer") and Analog Devices, Inc. ("ADI"), with its principal place of business at One Technology Way, Norwood, MA 02062, USA. Subject to the terms and conditions of the Agreement, ADI hereby grants to Customer a free, limited, personal, temporary, non-exclusive, non-sublicensable, non-transferable license to use the Evaluation Board FOR EVALUATION PURPOSES ONLY. Customer understands and agrees that the Evaluation Board is provided for the sole and exclusive purpose referenced above, and agrees not to use the Evaluation Board for any other purpose. Furthermore, the license granted is expressly made subject to the following additional limitations: Customer shall not (i) rent, lease, display, sell, transfer, assign, sublicense, or distribute the Evaluation Board; and (ii) permit any Third Party to access the Evaluation Board. As used herein, the term "Third Party" includes any entity other than ADI, Customer, their employees, affiliates and in-house consultants. The Evaluation Board is NOT sold to Customer; all rights not expressly granted herein, including ownership of the Evaluation Board, are reserved by ADI. CONFIDENTIALITY. This Agreement and the Evaluation Board shall all be considered the confidential and proprietary information of ADI. Customer may not disclose or transfer any portion of the Evaluation Board to any other party for any reason. Upon discontinuation of use of the Evaluation Board or termination of this Agreement, Customer agrees to promptly return the Evaluation Board to ADI. ADDITIONAL RESTRICTIONS. Customer may not disassemble, decompile or reverse engineer chips on the Evaluation Board. Customer shall inform ADI of any occurred damages or any modifications or alterations it makes to the Evaluation Board, including but not limited to soldering or any other activity that affects the material content of the Evaluation Board. Modifications to the Evaluation Board must comply with applicable law, including but not limited to the RoHS Directive. TERMINATION. ADI may terminate this Agreement at any time upon giving written notice to Customer. Customer agrees to return to ADI the Evaluation Board at that time. LIMITATION OF LIABILITY. THE EVALUATION BOARD PROVIDED HEREUNDER IS PROVIDED "AS IS" AND ADI MAKES NO WARRANTIES OR REPRESENTATIONS OF ANY KIND WITH RESPECT TO IT. ADI SPECIFICALLY DISCLAIMS ANY REPRESENTATIONS, ENDORSEMENTS, GUARANTEES, OR WARRANTIES, EXPRESS OR IMPLIED, RELATED TO THE EVALUATION BOARD INCLUDING, BUT NOT LIMITED TO, THE IMPLIED WARRANTY OF MERCHANTABILITY, TITLE, FITNESS FOR A PARTICULAR PURPOSE OR NON-INFRINGEMENT OF INTELLECTUAL PROPERTY RIGHTS. IN NO EVENT WILL ADI AND ITS LICENSORS BE LIABLE FOR ANY INCIDENTAL, SPECIAL, INDIRECT, OR CONSEQUENTIAL DAMAGES RESULTING FROM CUSTOMER'S POSSESSION OR USE OF THE EVALUATION BOARD, INCLUDING BUT NOT LIMITED TO LOST PROFITS, DELAY COSTS, LABOR COSTS OR LOSS OF GOODWILL. ADI'S TOTAL LIABILITY FROM ANY AND ALL CAUSES SHALL BE LIMITED TO THE AMOUNT OF ONE HUNDRED US DOLLARS (\$100.00). EXPORT. Customer agrees that it will not directly or indirectly export the Evaluation Board to another country, and that it will comply with all applicable United States federal laws and regulations relating to exports. GOVERNING LAW. This Agreement shall be governed by and construed in accordance with the substantive laws of the Commonwealth of Massachusetts (excluding conflict of law rules). Any legal action regarding this Agreement will be heard in the state or federal courts having jurisdiction in Suffolk County, Massachusetts, and Customer hereby submits to the personal jurisdiction and venue of such courts. The United Nations Convention on Contracts for the International Sale of Goods shall not apply to this Agreement and is expressly disclaimed.