

6

5

4

3

2

1

APPROVED: _____

DATE: _____ TITLE: _____

Rev	AWO #	Description	Date	Appr
-		RELEASED	10/28/22	

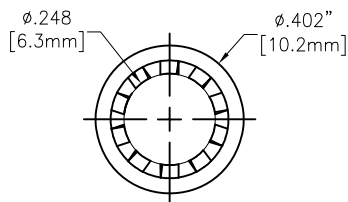
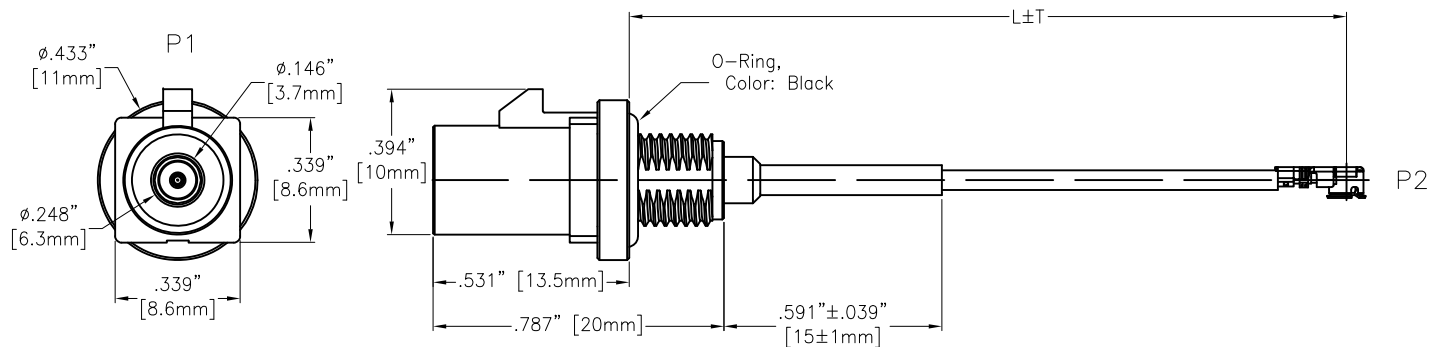

Lock Washer:
Nickel

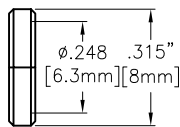

Hex Nut:
1/4-36UNS,
Nickel

- For SIP
- For CmK/Cpk

Coding
(See sht 2)

CA-FMP1-XX001XWP

ADAM P/N	L+T	
CA-FMP1-XX001005WP	1.969"±.197"	[50±5mm]
CA-FMP1-XX001010WP	3.937"±.197"	[100±5mm]
CA-FMP1-XX001015WP	5.906"±.197"	[150±5mm]

SPECIFICATIONS:

Connector:

P1= FAKRA Plug Code See page2, Straight, Terminal: Brass Gold Plated, Shell: Brass, Nickel
Overmold: Hi-Temp Thermoplastic, HF, Color: White

P2= I-PEX MHF20351, Gold plated

Cable:

30AWG, OD.: .054" [1.37mm], Jacket Color: Grey

Electrical:

Impedance: 50ohm

Temperature Rating:

Operating temperature: -40°C to +90°C

Electrical Test:

All Assemblies must be 100% Tested for
Shorts, Open, Continuity, and Physical Appearance.

Environmental:

IP Rating: IP67 (Connector to Panel)

Lead free, RoHS compliant



UNLESS OTHERWISE SPECIFIED ALL DIMENSIONS ARE INCHES [MM]. TOLERANCES: EXCEPT AS NOTED		
INCHES		HOLES
.X ±.10	Ø.X ±.10	
.XX ±.020	Ø.XX ±.015	
.XXX ±.015	Ø.XXX ±.010	
DRAWN	WX	10/28/22
CHECKED	RC	10/28/22
APPROVED		
THIS DRAWING CONTAINS INFORMATION THAT IS PROPRIETARY AND SHOULD NOT BE USED WITHOUT PRIOR WRITTEN PERMISSION FROM ADAM TECH		

ADAM TECH 909 Rahway Avenue,
Union, NJ 07083
Phone: 908-687-5000
Fax: 908-687-5710

TITLE
CUSTOM CABLE ASSEMBLY, FAKRA PLUG STRAIGHT
TO I-PEX MHF20351, 30AWG, IP67 RATED

SIZE X	PART NO. CA-FMP1-XX001XWP	REV. -
REF: S00013T	SCALE: NTS	SHEET 1 OF 2

6

5

4

3

2

1

6

5

4

3

2

1

APPROVED: _____

DATE: _____ TITLE: _____

Rev	AWO #	Description	Date	Appr
-----	-------	-------------	------	------

SEE SHT 1 OF 2 FOR REVISION

Fakra Jack

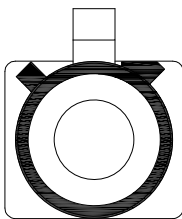
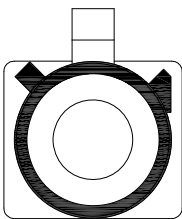
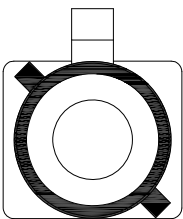
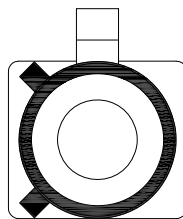
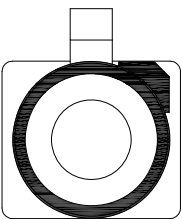
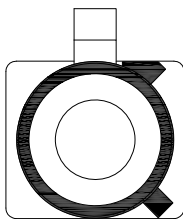
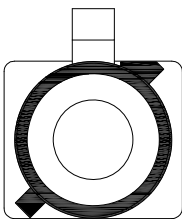
Coding	A	B	C	D	E	F	G
Plug							
Color	Black	White	Blue	Bordeaux Violet	Green	Brown	Grey

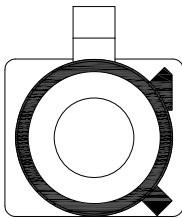
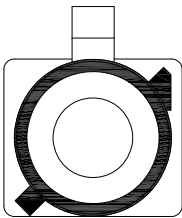
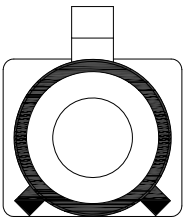
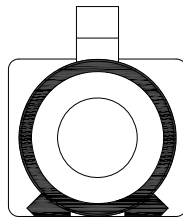
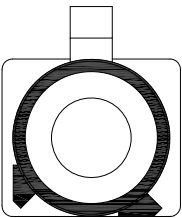
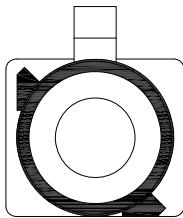
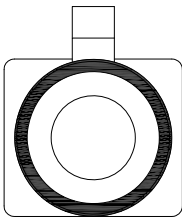
Coding	H	I	K	L	M	N	Z
Plug							
Color	Violet	Beige	Curry	Camine Red	Pastel Orange	Pastel Green	Water Blue

CA-FMP1-XX001XWP

P1 Coding

(Replace X with coding letter)

UNLESS OTHERWISE SPECIFIED ALL DIMENSIONS ARE INCHES [MM]. TOLERANCES: EXCEPT AS NOTED			 909 Rahway Avenue, Union, NJ 07083 Phone: 908-687-5000 Fax: 908-687-5710															
<table border="1"> <tr> <td colspan="2">INCHES</td> <td colspan="2">HOLES</td> </tr> <tr> <td>.X ±.10</td> <td>∅X ±.10</td> <td colspan="2"></td> </tr> <tr> <td>.XX ±.020</td> <td>∅XX ±.015</td> <td colspan="2"></td> </tr> <tr> <td>.XXX ±.015</td> <td>∅XXX ±.010</td> <td colspan="2"></td> </tr> </table>					INCHES		HOLES		.X ±.10	∅X ±.10			.XX ±.020	∅XX ±.015			.XXX ±.015	∅XXX ±.010
INCHES		HOLES																
.X ±.10	∅X ±.10																	
.XX ±.020	∅XX ±.015																	
.XXX ±.015	∅XXX ±.010																	
DRAWN	WX	10/28/22	TITLE															
CHECKED	RC	10/28/22	CUSTOM CABLE ASSEMBLY, FAKRA PLUG STRAIGHT TO I-PEX MHF20351, 30AWG, IP67 RATED															
APPROVED			SIZE	PART NO.														
THIS DRAWING CONTAINS INFORMATION THAT IS PROPRIETARY AND SHOULD NOT BE USED WITHOUT PRIOR WRITTEN PERMISSION FROM ADAM TECH			X	CA-FMP1-XX001XWP														
			REF: S00013T	SCALE: NTS	REV. -													
			SHEET 2 OF 2															

6

5

4

3

2

1