

**396** **0%**  
MERCURY

SR726W (SR59)  
Watch Battery OEM  
Swiss Made

## Technical Data Sheet

### Specifications

Chemical system	Zinc / Monovalent Silver Oxide, high drain
Nominal Voltage	1,55 V
Capacity	32 mAh, Discharge over 25,5 kΩ at 20°C to 1,2 V
Operating Temperature*	-10°C – 60°C
Self Discharge	Less than 10% per year at 20°C
Weight	~0,48 g

### Dimensions

(according IEC 60086-3)

Diameter	7,90 mm (0,311")
Height	2,60 mm (0,102")

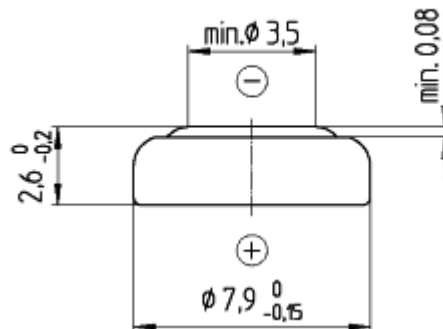

### Discharge Curve

Constant Load	25,5 kΩ
Starting Drain	61,9 μA
Temperature	20°C

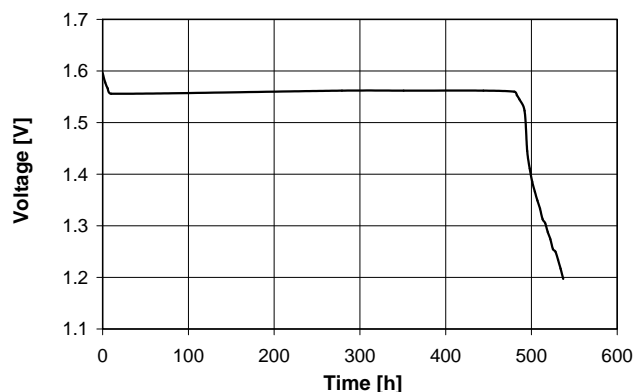

Information and contents in this data sheet are for reference purpose only. They do not constitute any warranty or representation and are subject to change without notice. For most current information and further details, please contact your Renata representative. For safety related information please consult the PSDS document related to that product or product family.

\*Condensing humidity not allowed

Rev. 396MF\_OEM.05 2017/07