



LOW PROFILE HYBRID (LPH)[®]™ INTERCONNECT SYSTEMS

LPH Receptacle Assembly	LPH Plug Assembly
	
Series: 45984	Series: 45985

[LPH Interconnect System Web Page](#)

[TABLE OF CONTENTS](#)



REVISION:	ECM INFORMATION:	TITLE:				SHEET No.
H	EC No: 624413 DATE: 2019/09/25	PRODUCT SPECIFICATION FOR LOW PROFILE HYBRID (LPH)[®]™ INTERCONNECT SYSTEMS				1 of 18
DOCUMENT NUMBER:	DOC TYPE:	DOC PART:	CREATED / REVISED BY:	CHECKED BY:	APPROVED BY:	
PS-45984-001	PS	001	MBN02	MBELLE	HTHYAGARAJ	

Table of Contents

<u>ITEMS</u>	<u>PAGE</u>
1.0 SCOPE	3
2.0 PRODUCT DESCRIPTION	3
2.1 DESCRIPTION, SERIES NUMBER, AND LINKS	3
2.2 DIMENSIONS, MATERIALS, PLATINGS	3
2.3 ENVIRONMENTAL CONFORMANCE	3
2.4 SAFETY AGENCY LISTINGS	3
3.0 APPLICABLE DOCUMENTS AND SPECIFICATION	4
3.1 MOLEX DOCUMENTS	4
3.2 INDUSTRY DOCUMENTS	4
4.0 ELECTRICAL PERFORMANCE RATINGS	4
4.1 VOLTAGE	4
4.2 CURRENT**	5
4.3 TEMPERATURE	8
4.4 DURABILITY	8
5.0 QUALIFICATION	8
6.0 PERFORMANCE	9
6.1 ELECTRICAL PERFORMANCE	9
6.2 MECHANICAL PERFORMANCE	10
6.3 ENVIRONMENTAL PERFORMANCE	11
7.0 TEST SEQUENCE GROUPS	12
8.0 MATING AND ALIGNMENT	14
8.1 Right Angle Receptacle to Edge Card	14
8.2 Right Angle Receptacle to Right Angle Plug	14
8.3 Right-Angle Plug and Right-Angle Receptacle Fully Mated Condition	15
8.4 Reference Dimensions	15
9.0 SOLDER INFORMATION	17
9.1 SOLDER PROCESS TEMPERATURES	17
9.2 REFLOW SOLDERING PROFILE	17
10.0 PACKAGING	18

[LPH Interconnect System Web Page](#)

[TABLE OF CONTENTS](#)



REVISION: H	ECM INFORMATION: EC No: 624413 DATE: 2019/09/25	TITLE: PRODUCT SPECIFICATION FOR LOW PROFILE HYBRID (LPH)[®]™ INTERCONNECT SYSTEMS	SHEET No. 2 of 18
DOCUMENT NUMBER: PS-45984-001	DOC TYPE: PS	DOC PART: 001	CREATED / REVISED BY: MBN02
	CHECKED BY: MBELLE	APPROVED BY: HTHYAGARAJ	

1.0 SCOPE

This specification covers the performance requirements and test methods for the following products listed by series numbers:

45984-**** LPH Receptacle Assembly
 45985-**** LPH Plug Assembly

2.0 PRODUCT DESCRIPTION

2.1 DESCRIPTION, SERIES NUMBER, AND LINKS

The Low-Profile Header (LPH) interconnect system consists of a right-angle plug and a right-angle receptacle. Each can be configured with 2 to 10 power contacts and 12 to 40 signal contacts. Additional options include guides and board mounting pegs. Receptacle can also mate to 1.57±0.15 mm / .062" ± .006" thick card edge. Both plug and receptacle connectors are through-hole solder into printed circuit boards and provide co-planer mate-ability.

DESCRIPTION	SERIES NUMBER
LPH Right Angle Receptacle Header Assembly	45984
LPH Right Angle Plug Header Assembly	45985

2.2 DIMENSIONS, MATERIALS, PLATINGS

Dimensions: See individual sales drawings.
 Material: RoHS compliant materials (LCP for housings, copper alloy for terminals).
 Plating: Gold on mating surfaces and tin at PC tail with nickel under-plating overall.

2.3 ENVIRONMENTAL CONFORMANCE

To find product compliance information:

- [Go to molex.com](#)
- Enter the part number in the search field.
- At the bottom of the page go to "Environmental" to see compliance status.

2.4 SAFETY AGENCY LISTINGS

UL File Number: E29179
 CSA File Number: LR19980

[LPH Interconnect System Web Page](#)

[TABLE OF CONTENTS](#)



REVISION: H	ECM INFORMATION: EC No: 624413 DATE: 2019/09/25	TITLE: PRODUCT SPECIFICATION FOR LOW PROFILE HYBRID (LPH)[®]™ INTERCONNECT SYSTEMS	SHEET No. 3 of 18
DOCUMENT NUMBER: PS-45984-001	DOC TYPE: PS	DOC PART: 001	CREATED / REVISED BY: MBN02
	CHECKED BY: MBELLE	APPROVED BY: HTHYAGARAJ	

3.0 APPLICABLE DOCUMENTS AND SPECIFICATION

3.1 MOLEX DOCUMENTS

See sales drawings and other sections of this specifications for the necessary referenced documents and specification.

Assembly Drawings: SD-45984-****, SD-45985-****, 459840200, 459850200

[Molex Solderability Specification SMES-152](#)

[Molex Heat Resistance Specification AS-40000-5013](#)

[Molex Package Handling Specification 454990100-PK](#)

3.2 INDUSTRY DOCUMENTS

EIA-364-1000

UL-60950-1

CSA STD C22.2 NO. 182.3-M1987

4.0 ELECTRICAL PERFORMANCE RATINGS

4.1 VOLTAGE

250 Volts AC (RMS)/DC (Power)

30 Volts DC (Signal)

Connector Rating per UL-1977

Connector voltage rating meets the connector approval level defined by UL 1977, Sect. 11 for spacing per table 11.1. Example: 1.2 mm for \leq 250 volt; 3.2 mm for \geq 250 volt.

Exception taken for spacing less than those specified are permitted, if the device complies with the requirements in the dielectric voltage withstanding test per Sect.17.

Application Voltage Guideline

For application voltage requirements please refer to UL-60950 or other applicable standards, the creepage & clearance also needs to be determined based upon pads/traces on the PCB.

[LPH Interconnect System Web Page](#)

[TABLE OF CONTENTS](#)



REVISION: H	ECM INFORMATION: EC No: 624413 DATE: 2019/09/25	TITLE: PRODUCT SPECIFICATION FOR LOW PROFILE HYBRID (LPH)[®]™ INTERCONNECT SYSTEMS	SHEET No. 4 of 18
DOCUMENT NUMBER: PS-45984-001	DOC TYPE: PS	DOC PART: 001	CREATED / REVISED BY: MBN02
		CHECKED BY: MBELLE	APPROVED BY: HTHYAGARAJ

4.2 CURRENT**

When tested in accordance with EIA-364-TP70:
(Tested to 30deg.C max. rise above ambient)

Ckt. Size	2	4	6	8	10
Current	TBD	30 Amperes	27 Amperes	23 Amperes	20 Amperes

Signal Contact: 1 Ampere per contact

** Current rating is application dependent. Above rating is for reference only. Appropriate de-rating is required per ambient conditions, copper weight of PCB needed to achieve thermal balance, gross heating from adjacent components, and other factors that influence connector performance.

4.2.1 CURRENT INTERRUPTION

30 Amps @ 48 Vdc – Power
1.0 Amp @ 30 Vdc – Signal

Low Profile Hybrid Temperature Rise vs. Current

8 Circuit & 4 Circuit Max.
4 oz. Copper PCB

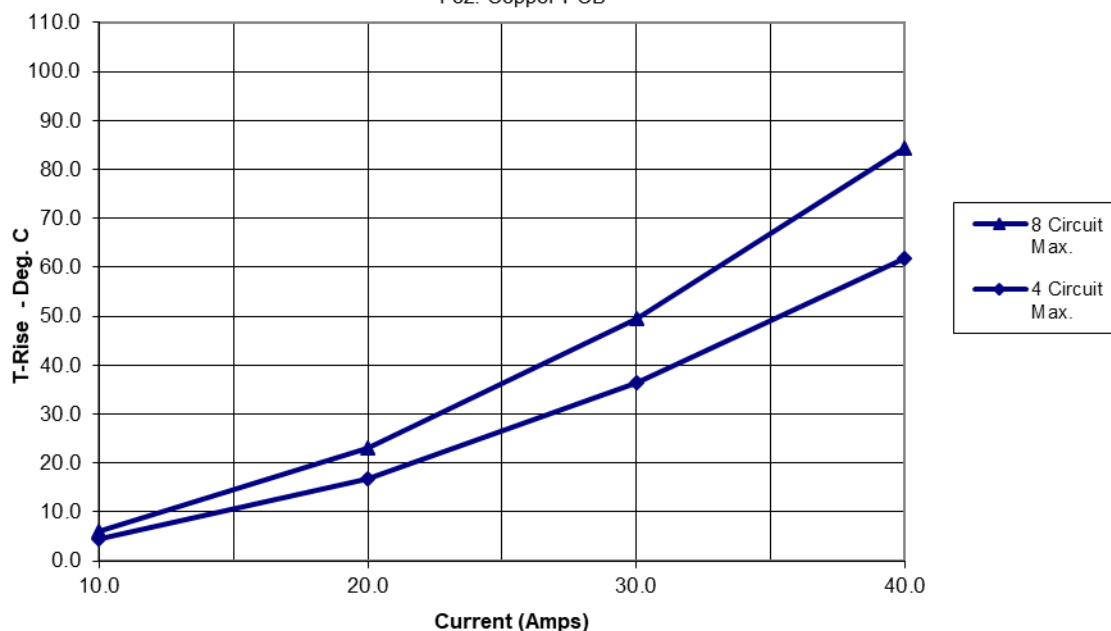

[LPH Interconnect System Web Page](#)

[TABLE OF CONTENTS](#)



REVISION: H	ECM INFORMATION: EC No: 624413 DATE: 2019/09/25	TITLE: PRODUCT SPECIFICATION FOR LOW PROFILE HYBRID (LPH)[®]™ INTERCONNECT SYSTEMS	SHEET No. 5 of 18
DOCUMENT NUMBER: PS-45984-001	DOC TYPE: PS	DOC PART: 001	CREATED / REVISED BY: MBN02
	CHECKED BY: MBELLE	APPROVED BY: HTHYAGARAJ	

**Low Profile Hybrid
Temperature Rise vs.
Current**
8 Circuit & 4 Circuit Max.
10 oz. Copper PCB

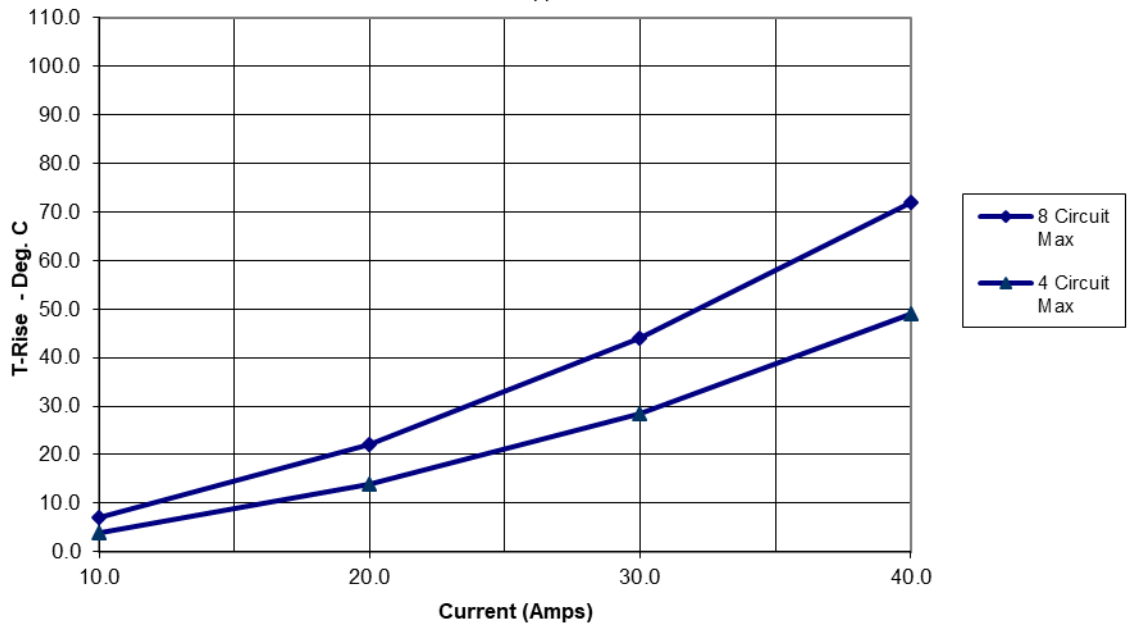

[LPH Interconnect System Web Page](#)

[TABLE OF CONTENTS](#)



REVISION: H	ECM INFORMATION: EC No: 624413 DATE: 2019/09/25	TITLE: PRODUCT SPECIFICATION FOR LOW PROFILE HYBRID (LPH)[®]™ INTERCONNECT SYSTEMS	SHEET No. 6 of 18
DOCUMENT NUMBER: PS-45984-001	DOC TYPE: PS	DOC PART: 001	CREATED / REVISED BY: MBN02
	CHECKED BY: MBELLE	APPROVED BY: HTHYAGARAJ	

Low Profile Hybrid
Voltage Drop Vs. Current
 8 Circuit & 4 circuit
 4 oz. Copper PCB

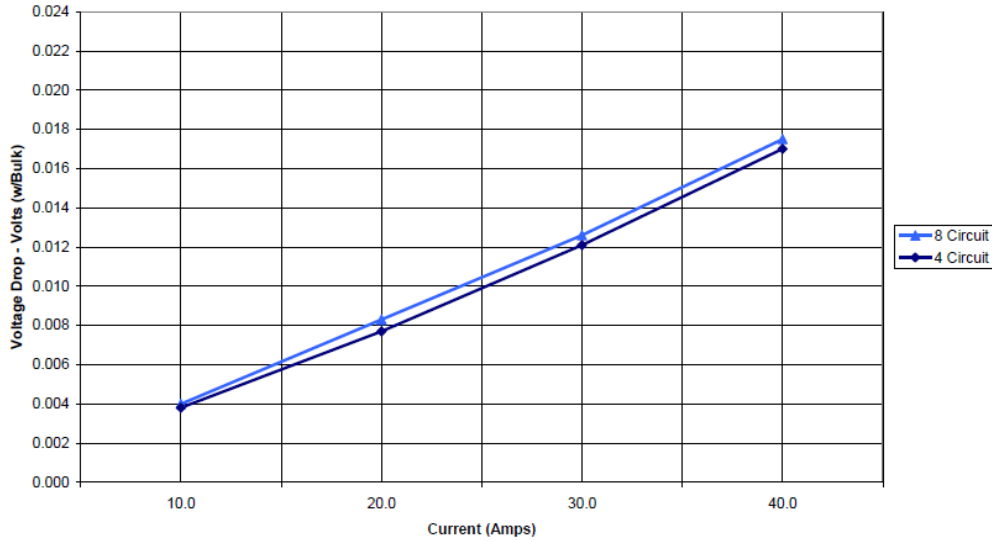

Low Profile Hybrid
Voltage Drop Vs. Current
 8 Circuit & 4 Circuit
 10 oz. Copper PCB

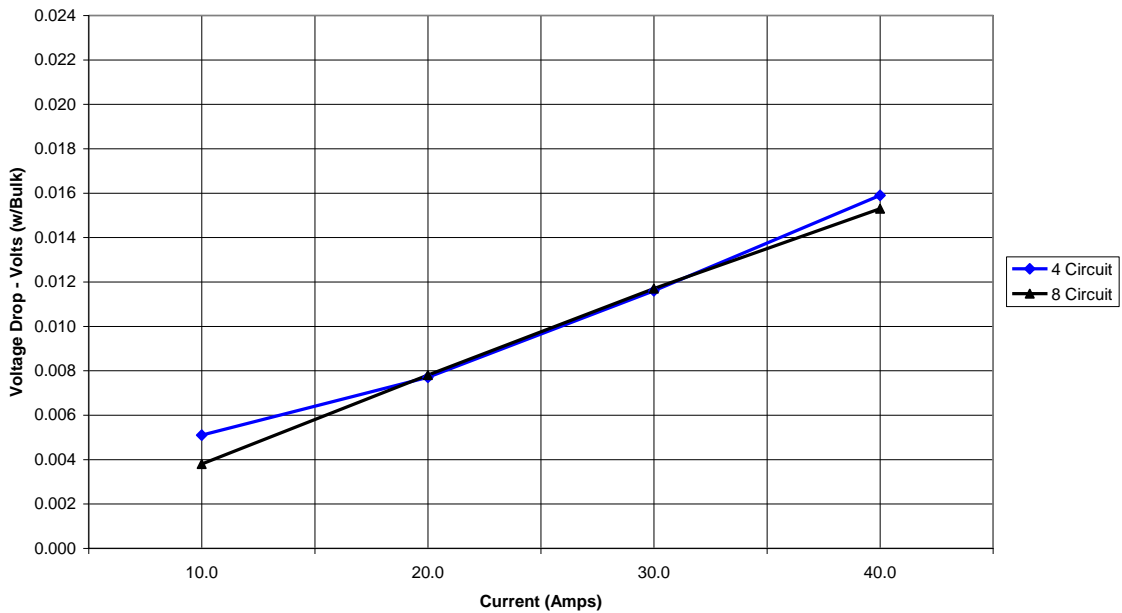

[LPH Interconnect System Web Page](#)

[TABLE OF CONTENTS](#)



REVISION: H	ECM INFORMATION: EC No: 624413 DATE: 2019/09/25	TITLE: PRODUCT SPECIFICATION FOR LOW PROFILE HYBRID (LPH)[®]™ INTERCONNECT SYSTEMS	SHEET No. 7 of 18
DOCUMENT NUMBER: PS-45984-001	DOC TYPE: PS	DOC PART: 001	CREATED / REVISED BY: MBN02
	CHECKED BY: MBELLE	APPROVED BY: HTHYAGARAJ	

4.3 TEMPERATURE

Operating Temperature Range (includes T-Rise from applied current): - 40°C to + 105°C
 Non-Operating : - 40°C to + 105°C

Field Temperature and Field Life: 60°C for 10 years (based EIA-364-1000, table 8)

Note: Temperature life test duration (section 6.3. item 2) is based on the assumption that the contact spends its entire life at the rated field maximum temperature (based on EIA-364-1000, table 8).

4.4 DURABILITY

Plating Type	Number of Cycles
Gold Plated	250

As tested in accordance with EIA-364-1000 test method (see sec 6.2 item 3 of this specification). Durability per EIA-364-09

5.0 QUALIFICATION

Laboratory condition, sample selection and test sequences are in accordance with EIA-364-1000.

[LPH Interconnect System Web Page](#)

[TABLE OF CONTENTS](#)



REVISION: H	ECM INFORMATION: EC No: 624413 DATE: 2019/09/25	TITLE: PRODUCT SPECIFICATION FOR LOW PROFILE HYBRID (LPH)[®]™ INTERCONNECT SYSTEMS				SHEET No. 8 of 18
DOCUMENT NUMBER: PS-45984-001	DOC TYPE: PS	DOC PART: 001	CREATED / REVISED BY: MBN02	CHECKED BY: MBELLE	APPROVED BY: HTHYAGARAJ	

6.0 PERFORMANCE

6.1 ELECTRICAL PERFORMANCE

ITEM	DESCRIPTION	TEST CONDITION	REQUIREMENT
6.1.1	Contact Resistance (Low Level) (EIA-364-23)	Mate connectors: apply a maximum voltage of 20 mV and a current of 100 mA.	Maximum Change: Signal Contact: 15 milliohm Power Contact: 0.75 milliohm
6.1.2	Contact Resistance (@Rated Current)	Mate connectors: apply maximum voltage of 20mV at the rated current.	Maximum Change: Signal Contact: 15 milliohm Power Contact: 0.75 milliohm
6.1.3	Insulation Resistance (EIA-364-21)	Apply 500 VDC between adjacent terminals or ground.	5,000 megohms minimum
6.1.4	Dielectric Withstanding Voltage (EIA-364-20)	Apply 1500 VDC for 1 minute between adjacent terminals or ground.	No breakdown
6.1.5	Temperature Rise	Mate connectors Measure T-Rise @ Rated Current after 96 Hours.	30° C T-Rise

[LPH Interconnect System Web Page](#)

[TABLE OF CONTENTS](#)



REVISION: H	ECM INFORMATION: EC No: 624413 DATE: 2019/09/25	TITLE: PRODUCT SPECIFICATION FOR LOW PROFILE HYBRID (LPH)[®]™ INTERCONNECT SYSTEMS	SHEET No. 9 of 18
DOCUMENT NUMBER: PS-45984-001	DOC TYPE: PS	DOC PART: 001	CREATED / REVISED BY: MBN02
	CHECKED BY: MBELLE	APPROVED BY: HTHYAGARAJ	

6.2 MECHANICAL PERFORMANCE

ITEM	DESCRIPTION	TEST CONDITION	REQUIREMENT
6.2.1	Mating Force, Single circuit (EIA-364-37)	Mate connectors at a rate of 25 +/- 6 mm per minute.	110 g per signal pin 700 g per Power Contact (Maximum Values)
6.2.2	Unmating Force, Single circuit (EIA-364-37)	Unmate connectors at a rate of 25 +/- 6 mm per minute.	15 g per signal pin 150 g per Power Contact (Minimum Values)
6.2.3	Durability w/o Environment (EIA-364-09)	Mate connectors 250 cycles at a maximum rate of 10 cycles per minute.	Maximum Change: Signal Contact: 15 milliohm Power Contact: 0.75milliohm
6.2.4	Normal Force	Apply perpendicular force to terminal at rate of 25 +/- 6 mm per minute	90 g per signal pin 300 g per Power Contact (Nominal Values)
6.2.5	Maximum connector (with pegs) mounting force into PCB	Mounting connectors at a rate of 25 +/- 6 mm per minute. Both pegs should be inserted into PCB at the same time with even force instead of slanted or one-sided insertion	Interference peg: 11000 g. (Maximum Values)
6.2.6	Vibration (EIA-364-28)	Mate connectors and vibrate per EIA-364-28, test condition VII-D, 15 minutes each axis	Maximum Change: Signal Contact: 15 milliohm Power Contact: 0.75 milliohm

[LPH Interconnect System Web Page](#)

[TABLE OF CONTENTS](#)



REVISION: H	ECM INFORMATION: EC No: 624413 DATE: 2019/09/25	TITLE: PRODUCT SPECIFICATION FOR LOW PROFILE HYBRID (LPH)[®]™ INTERCONNECT SYSTEMS	SHEET No. 10 of 18
DOCUMENT NUMBER: PS-45984-001	DOC TYPE: PS	DOC PART: 001	CREATED / REVISED BY: MBN02
	CHECKED BY: MBELLE	APPROVED BY: HTHYAGARAJ	

6.3 ENVIRONMENTAL PERFORMANCE

ITEM	DESCRIPTION	TEST CONDITION	REQUIREMENT
6.3.1	Thermal Shock (EIA-364-32)	Mate connectors, expose to 5 cycles from -55 °C to 85 °C per EIA-364-TP-32	Maximum Change: Signal Contact: 15 milliohm Power Contact: 0.75 milliohm
6.3.2	Temperature Life (EIA-364-17)	Mate Connectors, expose to 120 hours at 105 °C Per EIA-364-17 Method A	Maximum Change: Signal Contact: 15 milliohm Power contact: 0.75 milliohm
6.3.3	Cyclic temperature & humidity (EIA-364-31)	Mate connectors: expose to 24 cycles from 25 °C / 80% RH to 65 °C / 50% RH	Maximum Change: Signal Contact: 15 milliohm Power Contact: 0.75 milliohm
6.3.4	Mixed flowing Gas	168 hours unmated, 72 hours mated, per EIA-364-65 Class IIA	Maximum Change: Signal Contact: 15 milliohm Power Contact: 0.75 milliohm
6.3.5	Solder resistance (Wave)	Submerge terminal tails in solder. Dwell: 2.0 +/- 0.5 sec. Solder Temp: 260° C Max.	Visual: No damage to insulator material

[LPH Interconnect System Web Page](#)

[TABLE OF CONTENTS](#)



REVISION: H	ECM INFORMATION: EC No: 624413 DATE: 2019/09/25	TITLE: PRODUCT SPECIFICATION FOR LOW PROFILE HYBRID (LPH)[®]™ INTERCONNECT SYSTEMS	SHEET No. 11 of 18
DOCUMENT NUMBER: PS-45984-001	DOC TYPE: PS	DOC PART: 001	CREATED / REVISED BY: MBN02
	CHECKED BY: MBELLE	APPROVED BY: HTHYAGARAJ	

7.0 TEST SEQUENCE GROUPS

Reliability Test Sequences per EIA-364-1000

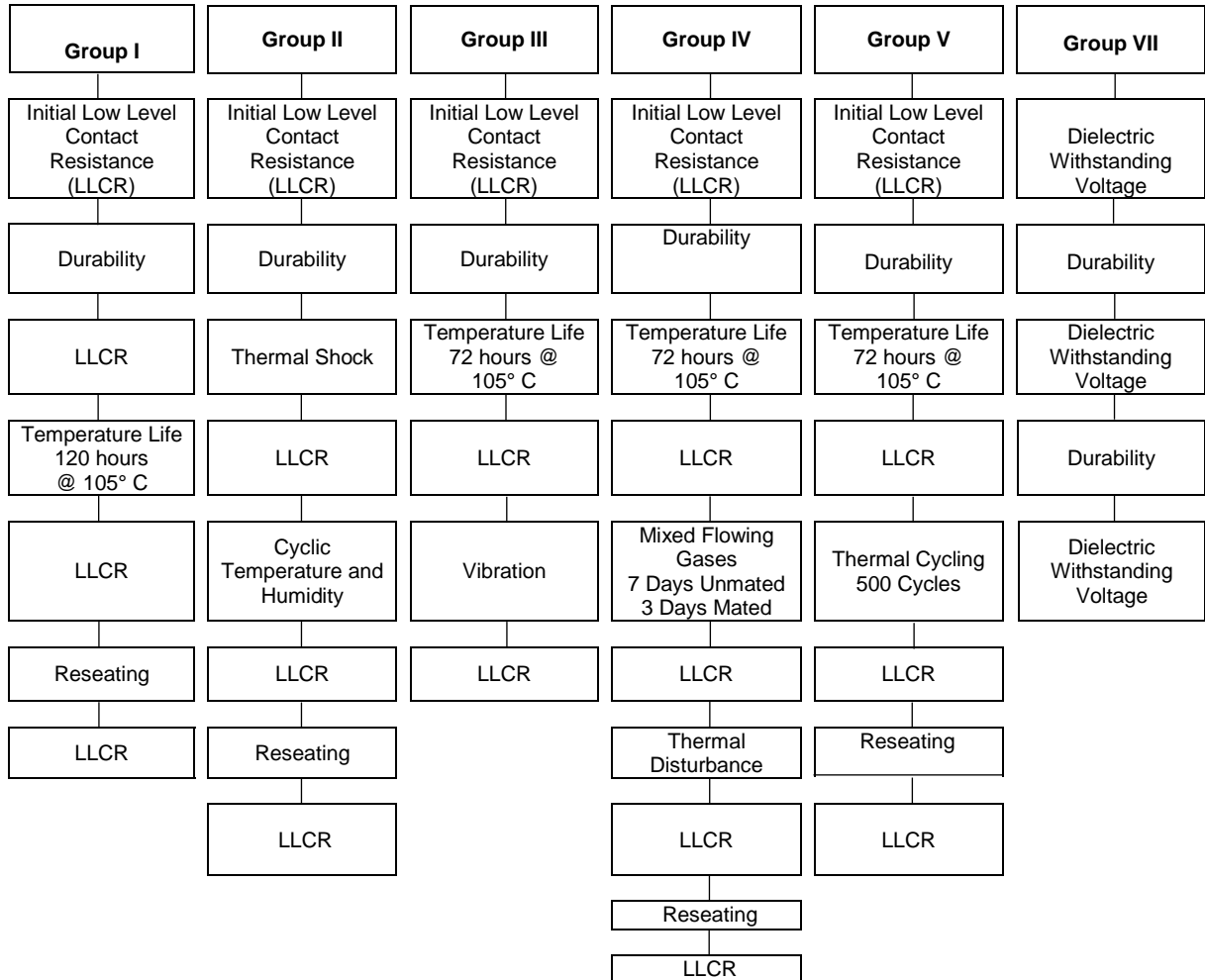

[LPH Interconnect System Web Page](#)

[TABLE OF CONTENTS](#)



REVISION: H	ECM INFORMATION: EC No: 624413 DATE: 2019/09/25	TITLE: PRODUCT SPECIFICATION FOR LOW PROFILE HYBRID (LPH)[®]™ INTERCONNECT SYSTEMS	SHEET No. 12 of 18
DOCUMENT NUMBER: PS-45984-001	DOC TYPE: PS	DOC PART: 001	CREATED / REVISED BY: MBN02
		CHECKED BY: MBELLE	APPROVED BY: HTHYAGARAJ

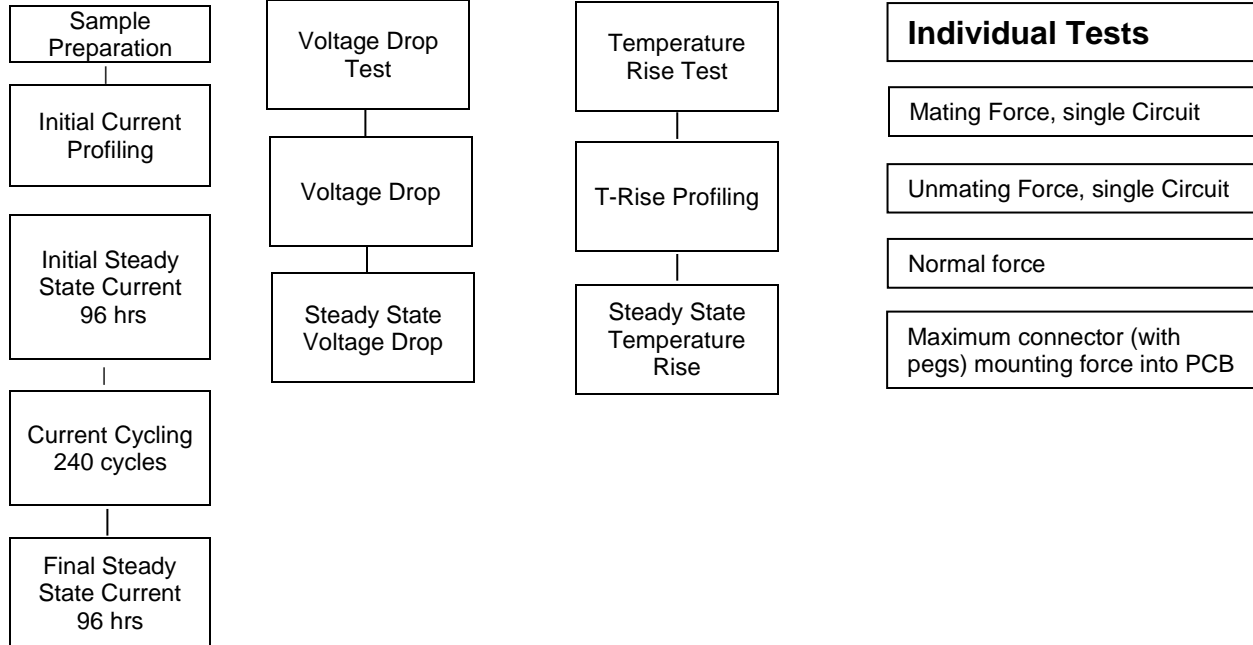

[LPH Interconnect System Web Page](#)

[TABLE OF CONTENTS](#)



REVISION: H	ECM INFORMATION: EC No: 624413 DATE: 2019/09/25	TITLE: PRODUCT SPECIFICATION FOR LOW PROFILE HYBRID (LPH)[®]™ INTERCONNECT SYSTEMS				SHEET No. 13 of 18
DOCUMENT NUMBER: PS-45984-001	DOC TYPE: PS	DOC PART: 001	CREATED / REVISED BY: MBN02	CHECKED BY: MBELLE	APPROVED BY: HTHYAGARAJ	

8.0 MATING AND ALIGNMENT

8.1 Right Angle Receptacle to Edge Card

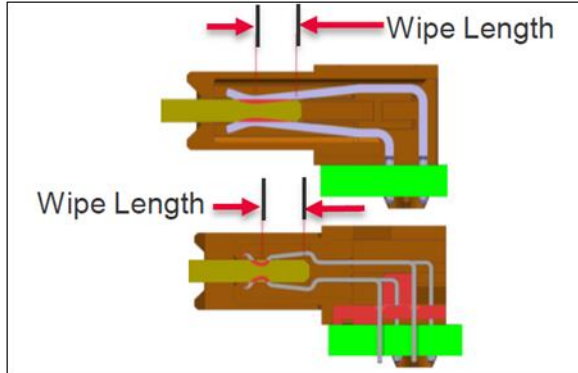

Final position/fully mated condition (LPH Power & Signal):

- 1. Power Terminal has 2.84mm nominal wipe.
- 2. Signal Terminal has 2.84mm nominal wipe.

8.2 Right Angle Receptacle to Right Angle Plug

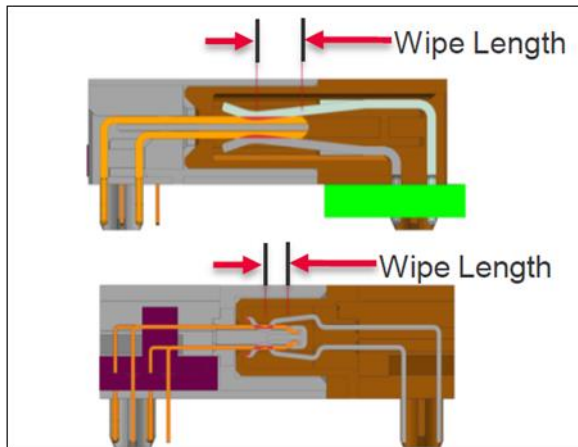

Final position/fully mated condition (LPH Power & Signal):

- 1. Long Power Terminal has 3.21mm nominal wipe.
- 2. Short Power Terminal has 1.70mm nominal wipe.
- 3. Signal Terminal has 1.27mm nominal wipe.

[LPH Interconnect System Web Page](#)

[TABLE OF CONTENTS](#)



REVISION: H	ECM INFORMATION: EC No: 624413 DATE: 2019/09/25	TITLE: PRODUCT SPECIFICATION FOR LOW PROFILE HYBRID (LPH)[®]™ INTERCONNECT SYSTEMS				SHEET No. 14 of 18
DOCUMENT NUMBER: PS-45984-001	DOC TYPE: PS	DOC PART: 001	CREATED / REVISED BY: MBN02	CHECKED BY: MBELLE	APPROVED BY: HTHYAGARAJ	

8.3 Right-Angle Plug and Right-Angle Receptacle Fully Mated Condition

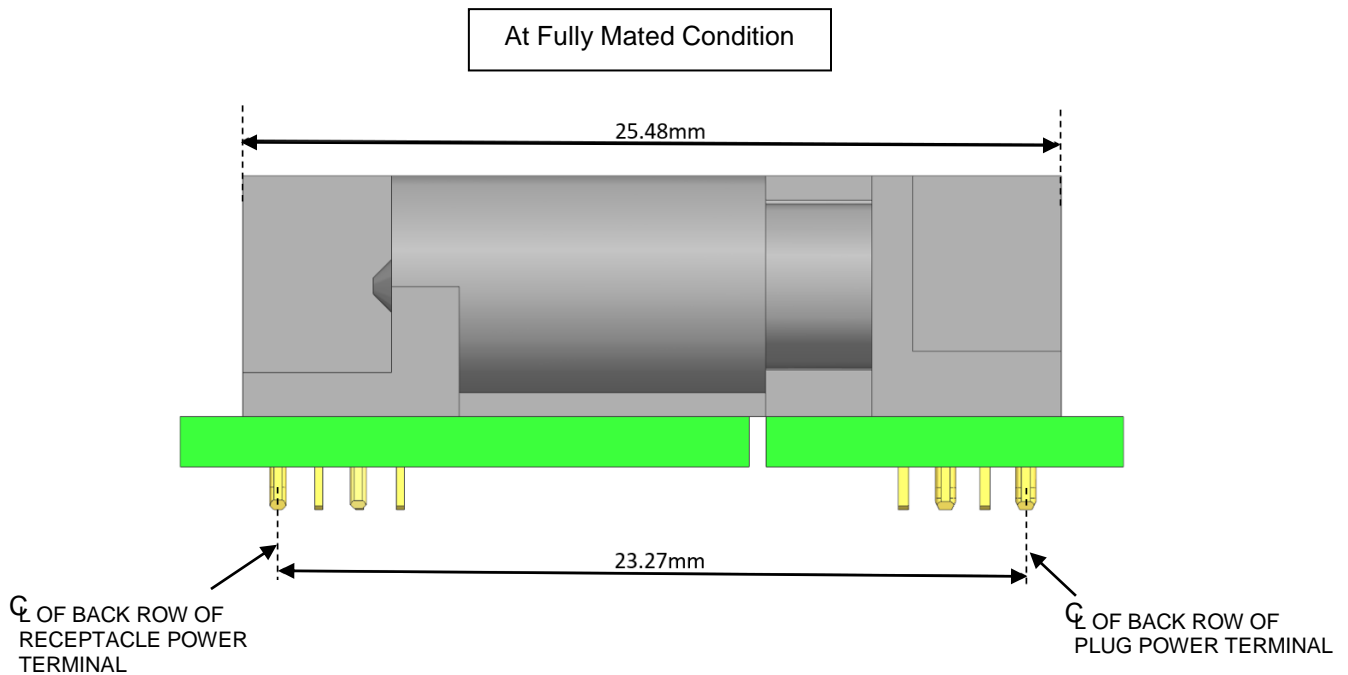

8.4 Reference Dimensions

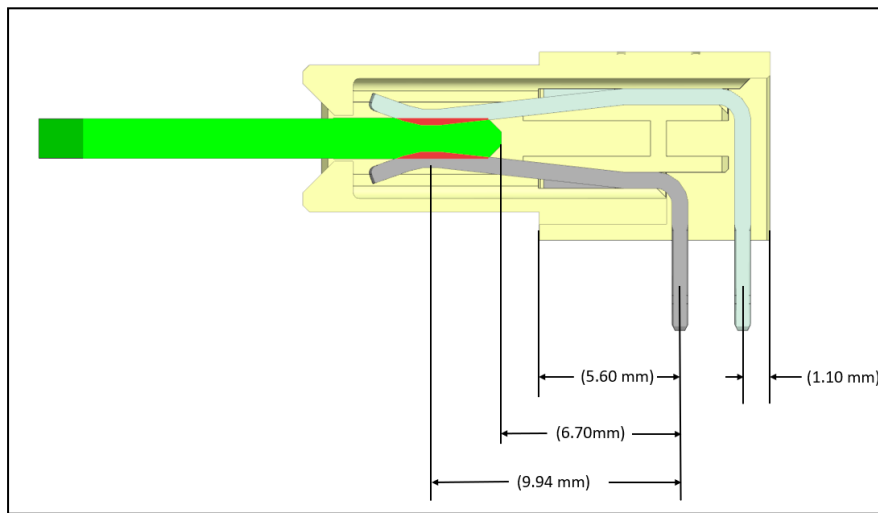

Edge Card mated with Hybrid Right-Angle Receptacle

[LPH Interconnect System Web Page](#)

[TABLE OF CONTENTS](#)



REVISION: H	ECM INFORMATION: EC No: 624413 DATE: 2019/09/25	TITLE: PRODUCT SPECIFICATION FOR LOW PROFILE HYBRID (LPH)[®]™ INTERCONNECT SYSTEMS				SHEET No. 15 of 18
DOCUMENT NUMBER: PS-45984-001	DOC TYPE: PS	DOC PART: 001	CREATED / REVISED BY: MBN02	CHECKED BY: MBELLE	APPROVED BY: HTHYAGARAJ	

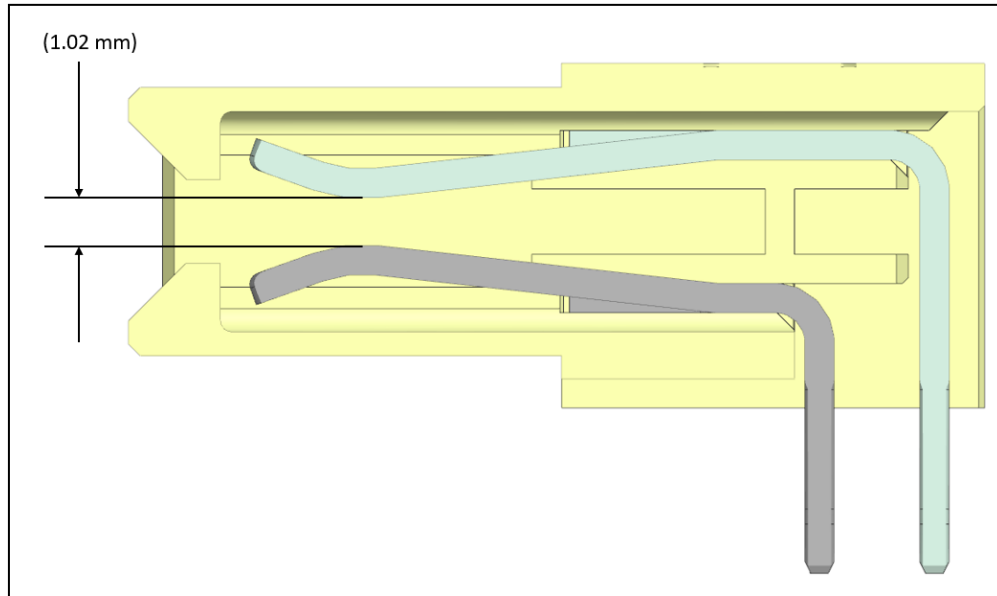

Hybrid Right-Angle Receptacle

Note:- These reference dimensions are applicable only for the Hybrid Version of Right-Angle Receptacle.

[LPH Interconnect System Web Page](#)

[TABLE OF CONTENTS](#)



REVISION: H	ECM INFORMATION: EC No: 624413 DATE: 2019/09/25	TITLE: PRODUCT SPECIFICATION FOR LOW PROFILE HYBRID (LPH)[®]™ INTERCONNECT SYSTEMS				SHEET No. 16 of 18
DOCUMENT NUMBER: PS-45984-001	DOC TYPE: PS	DOC PART: 001	CREATED / REVISED BY: MBN02	CHECKED BY: MBELLE	APPROVED BY: HTHYAGARAJ	

9.0 SOLDER INFORMATION

Per SMES-152 and AS-40000-5013

*These specifications establish standard solderability test methods used to evaluate a products ability to accept molten solder. Solder Process Temperatures and Reflow Solder Profiles will vary based on application, equipment, solder paste, PCB thickness, etc.

9.1 SOLDER PROCESS TEMPERATURES *

Wave Solder Temperature: 260°C Maximum
 Reflow Solder Temperature: 260°C Maximum

[Molex Solderability Specification SMES-152 \(Click Here\)](#)

9.2 REFLOW SOLDERING PROFILE *

[Molex Connector Heat Resistance Specification AS-40000-5013 \(Click Here\)](#)

(This profile is per JEDEC J-STD-020D.1 and it is for guideline only; please see notes for additional information)

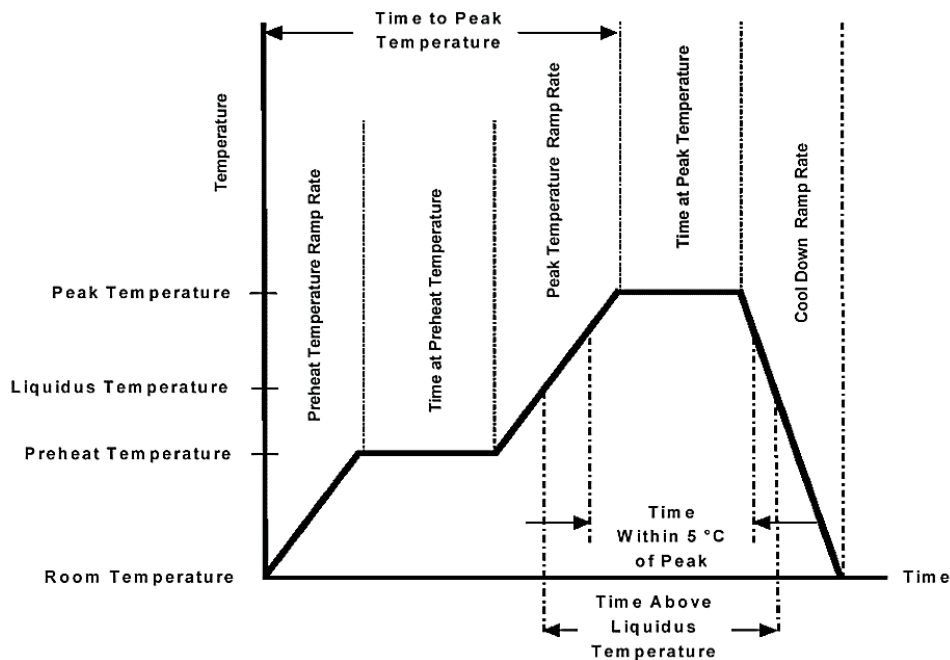

[LPH Interconnect System Web Page](#)

[TABLE OF CONTENTS](#)



REVISION: H	ECM INFORMATION: EC No: 624413 DATE: 2019/09/25	TITLE: PRODUCT SPECIFICATION FOR LOW PROFILE HYBRID (LPH)[®]™ INTERCONNECT SYSTEMS				SHEET No. 17 of 18
DOCUMENT NUMBER: PS-45984-001	DOC TYPE: PS	DOC PART: 001	CREATED / REVISED BY: MBN02	CHECKED BY: MBELLE	APPROVED BY: HTHYAGARAJ	

Description	Requirement
Average Ramp Rate	3°C/sec Max
Preheat Temperature	150°C Min to 200°C Max
Preheat Time	60 to 180 sec
Ramp to Peak	3°C/sec Max
Time over Liquidus (217°C)	60 to 150 sec
Peak Temperature	260 +0/-5°C
Time within 5°C of Peak	20 to 40 sec
Ramp - Cool Down	6°C/sec Max
Time 25°C to Peak	8 min Max

Notes:

1. Temperature indicated refers to the PCB surface temperature at solder tail area.
2. Connector can withstand up to 3 reflow cycles with a cool-down to room temperature in-between.
3. Actual reflow profile also depends on equipment, solder paste, PCB thickness, and other components on the board. Please consult your solder paste & reflow equipment manufacturer for their recommendations to adopt a suitable process.
4. For wave soldering, it is recommended to use interference peg design. (Diameter is 3.30mm) or use fixture to hold the part down during soldering. When mounting the connector into PCB by manual operation, it is required to press two side of the connector with even force on the connector to ensure the connector can be inserted into PCB smoothly.

10.0 PACKAGING

Parts shall be packaging to protect the parts from damage during standard shipping, storage, and handling. Refer Molex.com specific part number webpage to get the exact packaging document for that item.

[LPH Interconnect System Web Page](#)

[TABLE OF CONTENTS](#)



REVISION: H	ECM INFORMATION: EC No: 624413 DATE: 2019/09/25	TITLE: PRODUCT SPECIFICATION FOR LOW PROFILE HYBRID (LPH)[®]™ INTERCONNECT SYSTEMS	SHEET No. 18 of 18
DOCUMENT NUMBER: PS-45984-001	DOC TYPE: PS	DOC PART: 001	CREATED / REVISED BY: MBN02
	CHECKED BY: MBELLE	APPROVED BY: HTHYAGARAJ	