

BASE CAGE DETAILS

(APPLIES TO ALL CAGES IN THIS DRAWING)

747540410
SHOWN

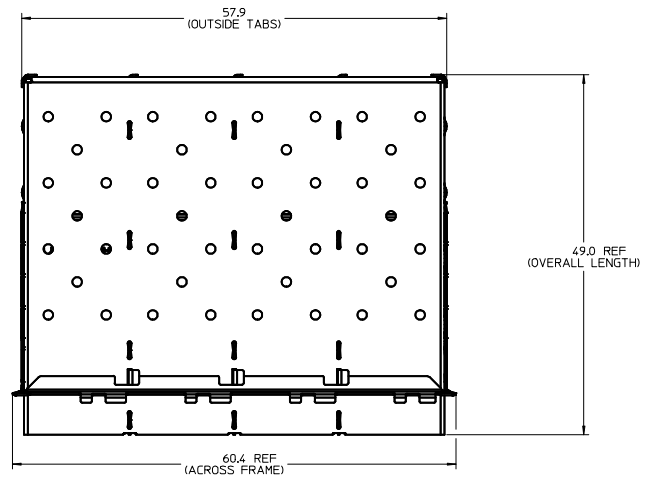

NOTE:
EMI GASKET REMOVED FROM THIS VIEW FOR CLARITY.

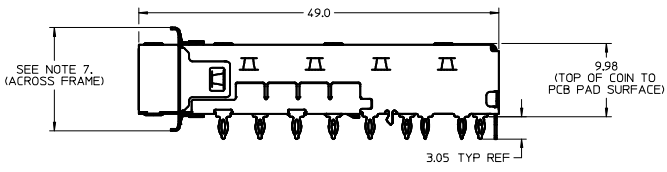
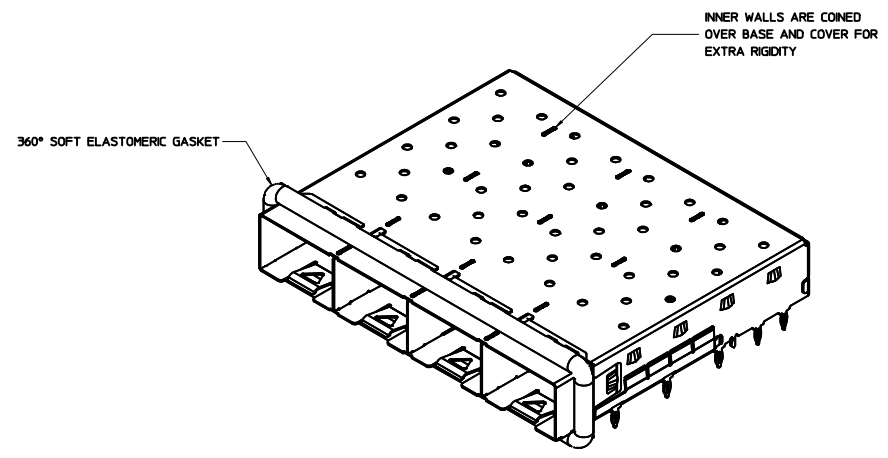
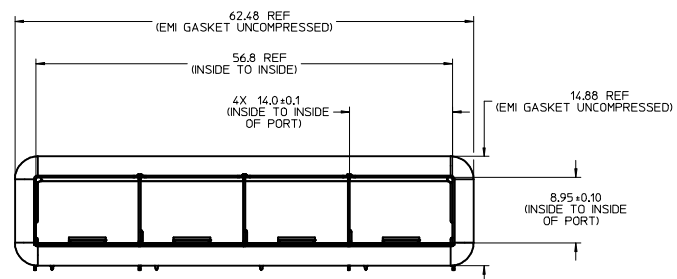

NOTE:
EMI GASKET REMOVED FROM THIS VIEW FOR CLARITY.

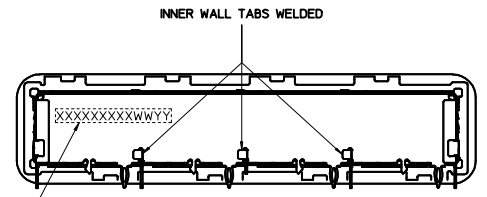

WEEK/YEAR DATE CODE TABLE	
WW	01 THRU 52 OR 53 EXAMPLE: 01 = FIRST WEEK OF YEAR 52 = LAST WEEK OF YEAR
YY	15, 16, 17 ETC. EXAMPLE: YEAR 2015 = 15

NOTES:

1. MATERIAL:
 CAGE: 0.25mm THICK COPPER ALLOY, NICKEL PLATED.
 SPRING FINGERS: 0.10mm THICK COPPER ALLOY, NICKEL PLATED.
 HEATSINK: ALUMINUM, NICKEL PLATED.
 HEATSINK SPRING CLIP: STAINLESS STEEL.
2. PRESS FIT LEGS 3.05mm (.120 INCH) LONG;
3. PORTS ARE DESIGNED FOR SFP+ TRANSCEIVERS AND ARE COMPATIBLE WITH SFP TRANSCEIVERS.
 THE TOP SURFACE OF THE MODULE MUST BE FLAT (NO PRODUCT LABEL RECESS) AND THERMALLY CONDUCTIVE TO FUNCTION OPTIMALLY.
4. WELD SPOT MAY SHOW SLIGHT MATERIAL DISCOLORATION.
5. NO ROHS EXEMPTIONS.
6. CUSTOM HEATSINKS AVAILABLE UPON REQUEST.
7. MOST OF P/N ARE WITH 14.05 REF EXCEPT 747540415 & 747540419 ARE 12.55 REF.

SEE REVISION TABLE	QUALITY SYMBOLS	GENERAL TOLERANCES (UNLESS SPECIFIED)	DIMENSION STYLE	SCALE	DESIGN UNITS	THIRD ANGLE PROJECTION
EIC NO: CPG2016-2975 DRAWN: ACHEN03 2016/02/03 CHKD: APPR: CHEN08 2016/02/04	∇=0 ∇=0 ∇=0	mm INCH 4 PLACES ± --- ± --- 3 PLACES ± --- ± --- 2 PLACES ± 0.13 ± --- 1 PLACE ± 0.25 ± --- 0 PLACE ± --- ± --- ANGULAR ± 1 ° DRAFT WHERE APPLICABLE MUST REMAIN WITHIN DIMENSIONS	MM ONLY DRAWN BY DATE JHATTON 2012/12/03 CHECKED BY DATE MCKERVEY 2012/12/07 APPROVED BY DATE KLLLOYD 2012/12/20	3:1	METRIC	
			MATERIAL NO. SEE SHEET 3	TITLE SFP+ 1X4 CAGE, 3.05MM PRESS FIT, HEAT SINK, ELASTOMERIC GASKET		SHEET NO. 1 OF 9
			DOCUMENT NO. SD-111112-2410			
THIS DRAWING CONTAINS INFORMATION THAT IS PROPRIETARY TO MOLEX INCORPORATED AND SHOULD NOT BE USED WITHOUT WRITTEN PERMISSION						

CAGE ASSEMBLY OPTIONS

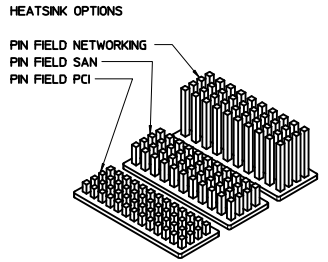
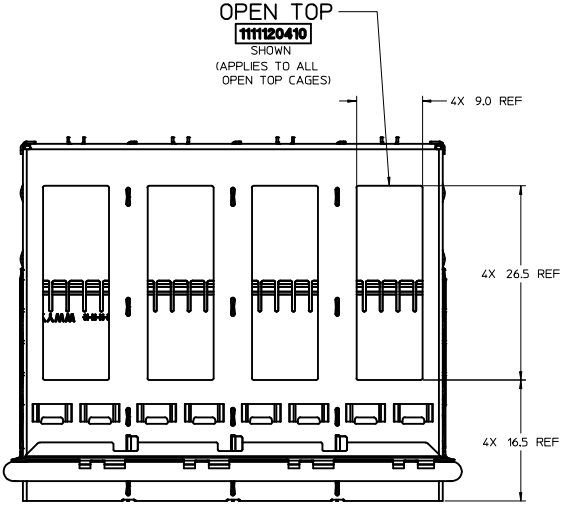

OVERALL HEATSINK HEIGHT

APPLICATION	DIM 'A'
PCI	14.3
SAN	16.6
NETWORKING	23.6

NOTE: PCI - 13 ROWS
SAN - 11 ROWS
NETWORKING - 10 ROWS

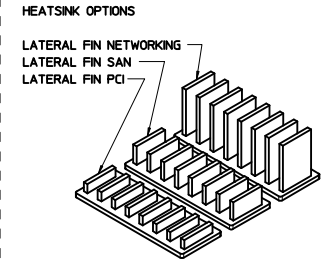

OVERALL HEATSINK HEIGHT

APPLICATION	DIM 'A'
PCI	14.3
SAN	16.6
NETWORKING	23.6

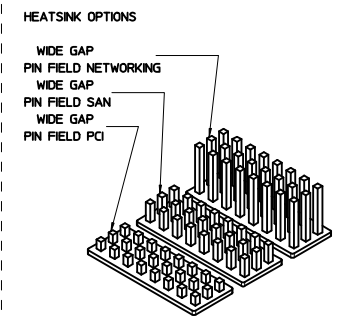

OVERALL HEATSINK HEIGHT

APPLICATION	DIM 'A'
PCI	14.3
SAN	16.6
NETWORKING	23.6

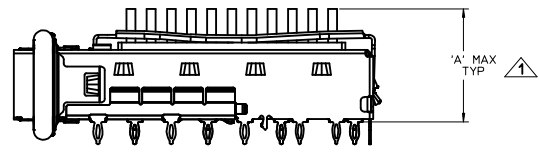

NOTES:
▲ HEIGHT OF HEATSINK WITH MODULE INSERTED.
DIMENSION MAY BE LESS DUE TO MODULE AND HEATSINK VARIATIONS.

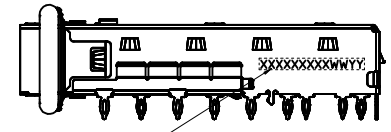
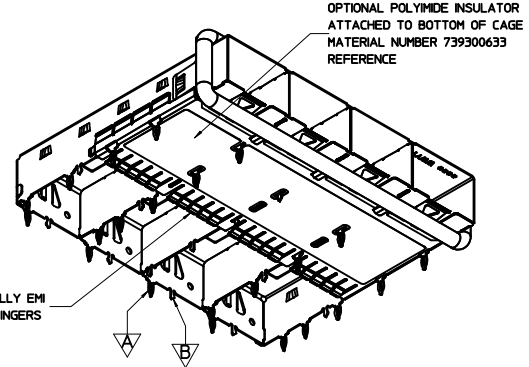

PART NO. AND WEEK/YEAR DATE CODE TO BE PRINTED ON BACK OF COMPLETED CAGE ASSEMBLY APPROXIMATELY AS SHOWN. SEE TABLE BELOW FOR DATE CODE INFORMATION.

WEEK/YEAR DATE CODE TABLE

WW	YY	EXAMPLE
01 THRU 52 OR 53	15, 16, 17 ETC.	01 = FIRST WEEK OF YEAR 52 = LAST WEEK OF YEAR

REAR LEG OPTIONS (PER PORT)

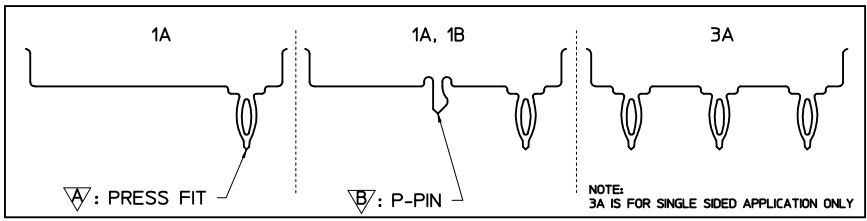

SEE REVISION TABLE EC NO: CPG2016-2975 CHKO: DRAWNACHENG03 APPROV: CHEN08 REV: 2016/02/04	QUALITY SYMBOLS ∇=0 ∇=0 ∇=0	GENERAL TOLERANCES (UNLESS SPECIFIED) mm INCH 4 PLACES ±--- ±--- 3 PLACES ±0.13 ±--- 2 PLACES ±0.25 ±--- 0 PLACE ±--- ±--- ANGULAR ± 1 ° DRAFT WHERE APPLICABLE MUST REMAIN WITHIN DIMENSIONS	DIMENSION STYLE MM ONLY SCALE 3:1 DESIGN UNITS METRIC THIRD ANGLE PROJECTION	DRAWN BY DATE JHATTON 2012/12/03 CHECKED BY DATE MCKERVEY 2012/12/07 APPROVED BY DATE KLOYD 2012/12/20	TITLE SFP+ 1X4 CAGE, 3.05MM PRESS FIT, HEAT SINK, ELASTOMERIC GASKET molex MATERIAL NO. SD-111112-2410 DOCUMENT NO. SD-111112-2410 SHEET NO. 2 OF 9
	THIS DRAWING CONTAINS INFORMATION THAT IS PROPRIETARY TO MOLEX INCORPORATED AND SHOULD NOT BE USED WITHOUT WRITTEN PERMISSION				
	SEE SHEET 3				
	INCORPORATED AND SHOULD NOT BE USED WITHOUT WRITTEN PERMISSION				

OPTIONAL GEN 2 UNDER BELLY GASKET

100114-0410

SHOWN

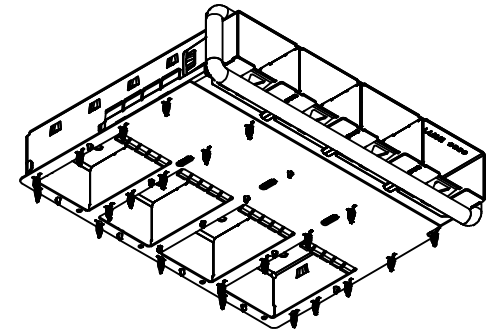
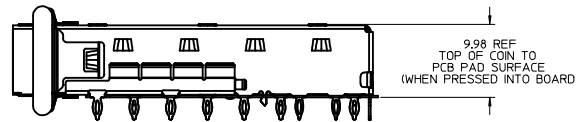
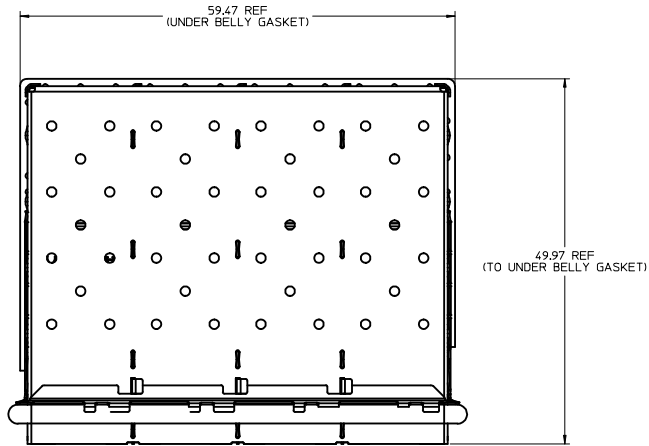

1. OPTIONAL UNDER BELLY GASKET ATTACHED TO BOTTOM OF CAGE (SEE P/N TABLES FOR AVAILABLE ASSEMBLIES)

ENTER DESCRIPTION IEC NO: CPG2016-2975 CHYD: CHYD03 APPR: RCHEN08 2016/02/04	QUALITY SYMBOLS	GENERAL TOLERANCES (UNLESS SPECIFIED)		DIMENSION STYLE	SCALE	DESIGN UNITS	THIRD ANGLE PROJECTION
	▽=0	4 PLACES	mm INCH	MM ONLY	3:1	METRIC	☉
	▽=0	3 PLACES					
	▽=0	2 PLACES					
		ANGULAR ± 1°					
		DRAFT WHERE APPLICABLE MUST REMAIN WITHIN DIMENSIONS					
				MATERIAL NO.	DOCUMENT NO.		SHEET NO.
				SEE TABLE	SD-111112-2410		3 OF 9
				THIS DRAWING CONTAINS INFORMATION THAT IS PROPRIETARY TO MOLEX INCORPORATED AND SHOULD NOT BE USED WITHOUT WRITTEN PERMISSION			

PART NUMBER SELECTION

1111120410
SHOWN

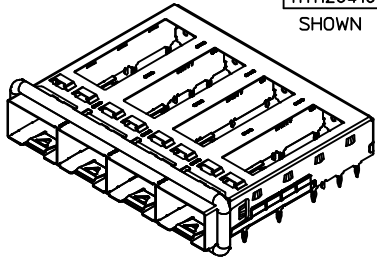

OPEN TOP BASE CAGE FOR HEATSINK		
PART NO.	POLYIMIDE INSULATOR	# OF REAR LEGS PER PORT
1111120410	---	1A, 1B
1111120450	YES	1A, 1B

1111122410
SHOWN

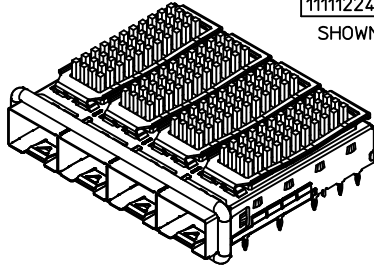

PIN FIELD HEATSINK OPTION			
PART NO.	POLYIMIDE INSULATOR	HEATSINK	# OF REAR LEGS PER PORT
1111121410	---	PCI	1A, 1B
1111121450	YES	PCI	1A, 1B
1111122410	---	SAN	1A, 1B
1111122450	YES	SAN	1A, 1B
1111123410	---	NET	1A, 1B
1111123450	YES	NET	1A, 1B

NOTE: PCI - 13 ROWS
SAN - 11 ROWS
NET - 10 ROWS

1111125410
SHOWN

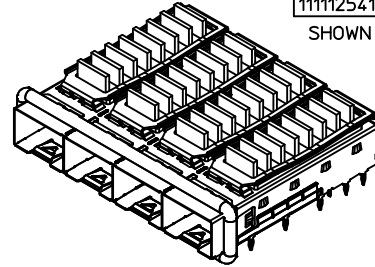

LATERAL FIN HEATSINK OPTION			
PART NO.	POLYIMIDE INSULATOR	HEATSINK	# OF REAR LEGS PER PORT
1111124410	---	PCI	1A, 1B
1111124450	YES	PCI	1A, 1B
1111125410	---	SAN	1A, 1B
1111125450	YES	SAN	1A, 1B
1111126410	---	NET	1A, 1B
1111126450	YES	NET	1A, 1B

1111128410
SHOWN

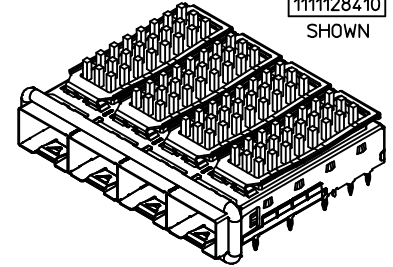

WIDE GAP PIN FIELD HEATSINK OPTION			
PART NO.	POLYIMIDE INSULATOR	HEATSINK	# OF REAR LEGS PER PORT
1111127410	---	PCI	1A, 1B
1111127450	YES	PCI	1A, 1B
1111128410	---	SAN	1A, 1B
1111128450	YES	SAN	1A, 1B
1111129410	---	NET	1A, 1B
1111129450	YES	NET	1A, 1B

747540410
SHOWN

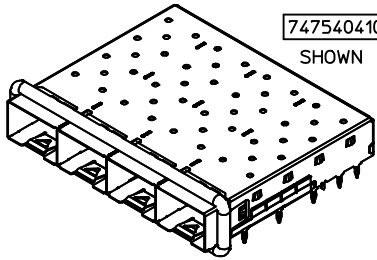

SFP+ CLOSED TOP BASE CAGE			
PART NO.	POLYIMIDE INSULATOR	# OF REAR LEGS PER PORT	ELASTOMERIC GASKET FLAMMABILITY RATING
747540410	---	1A, 1B	
747540411	---	3A	
747540415	---	1A, 1B	
747540419	---	1A, 1B	
747540470	---	1A, 1B	EQUATE TO UL94 V-0

1001140410
SHOWN

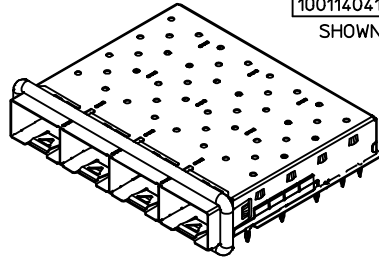

zSFP+ CLOSED TOP BASE CAGE W/ GEN 2 BELLY GASKET		
PART NO.	# OF REAR LEGS PER PORT	FLAMMABILITY RATING
1001140410	1A, 1B	N/A
1001144410	1A, 1B	UL94 V-0

SEE REVISION TABLE EC NO: CPG2016-2975 DRAWN: CHENG03 CHKD: APPR: CHEN08 2016/02/04	QUALITY SYMBOLS ▽=0 ▽=0 ▽=0	GENERAL TOLERANCES (UNLESS SPECIFIED) mm INCH		DIMENSION STYLE MM ONLY	SCALE 2:1	DESIGN UNITS METRIC	THIRD ANGLE PROJECTION	
		4 PLACES ± .13 ± .005 3 PLACES ± .13 ± .005 2 PLACES ± 0.13 ± .005 1 PLACE ± 0.25 ± .010 0 PLACE ± . ± .		ANGULAR ± 1 °		DRAWN BY: JHATTON DATE: 2012/12/03 CHECKED BY: MMCKERVEY DATE: 2012/12/07 APPROVED BY: K LLOYD DATE: 2012/12/20		TITLE SFP+ 1X4 CAGE, 3.05MM PRESS FIT, HEAT SINK, ELASTOMERIC GASKET molex
		DRAFT WHERE APPLICABLE MUST REMAIN WITHIN DIMENSIONS		MATERIAL NO. SEE TABLE		DOCUMENT NO. SD-11112-2410		
		THIS DRAWING CONTAINS INFORMATION THAT IS PROPRIETARY TO MOLEX INCORPORATED AND SHOULD NOT BE USED WITHOUT WRITTEN PERMISSION						

PCB LAYOUT FOR SINGLE SIDE MOUNT

HATCHED AREA DENOTES COMPONENTS AND TRACE KEEP-OUT (EXCEPT CHASSIS GROUND)

CROSS HATCHED AREA GOES TO CHASSIS GROUND (NO OSP) 4 PLCS

14X $\phi 1.05 \pm 0.05$ (SHOWN AS \oplus) $\phi 0.05$ AB

THIS AREA DENOTES COMPONENT KEEP-OUT (TRACES ALLOWED)

20X $\phi 0.95 \pm 0.05$ (SHOWN AS \bullet) $\phi 0.05$ AB

4X $\phi 0.95 \pm 0.05$ (SHOWN AS \bullet) $\phi 0.05$ AB
OPTIONAL HOLES FOR CAGES WITH 3 REAR LEGS PER PORT

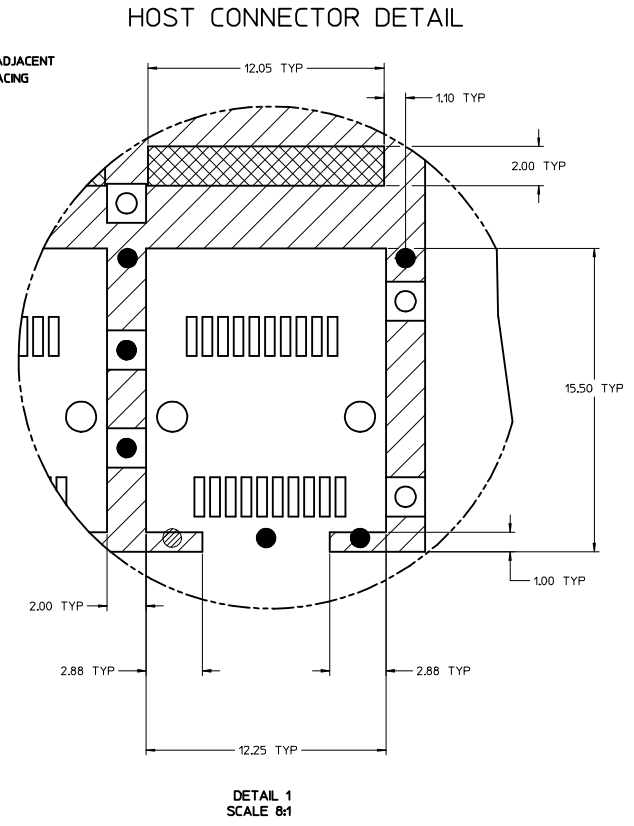

TOP LEFT HOLE OF ADJACENT CAGE AT MINIMUM SPACING

HOST CONNECTOR DETAIL

DETAIL 1 SCALE 8:1

- NOTES:
1. PADS AND VIAS CONNECT TO CHASSIS GROUND (RECOMMENDED PADS TO BE 2.00mm SQUARE)
 2. RECOMMENDED THRU HOLE PLATING INCLUDES HASL, OSP, OR IMMERSION (GOLD, SILVER, OR TIN)
 3. CONNECTOR PAD LAYOUT PER SFP+ MSA WILL ACCOMMODATE MOLEX CONNECTOR SERIES 74441 OR EQUIVALENT
 4. HOLE PATTERN REPEATS FOR EACH PORT, SPACING BETWEEN PORTS IS 14.25mm
 5. MINIMUM PCB THICKNESS FOR SINGLE SIDED USE 157mm [0.062"].

SEE REVISION TABLE EC NO: CPG2016-2975 DRAWN BY: JHATTON CHECKED BY: MMCKERVEY APPROVED BY: KLOYD DATE: 2016/02/03 DATE: 2012/12/03 DATE: 2012/12/07 DATE: 2012/12/20	QUALITY SYMBOLS $\nabla=0$ $\nabla=0$ $\nabla=0$	GENERAL TOLERANCES (UNLESS SPECIFIED) <table border="1"> <thead> <tr> <th></th> <th>mm</th> <th>INCH</th> </tr> </thead> <tbody> <tr> <td>4 PLACES</td> <td>±0.13</td> <td>±0.005</td> </tr> <tr> <td>3 PLACES</td> <td>±0.25</td> <td>±0.010</td> </tr> <tr> <td>2 PLACES</td> <td>±0.50</td> <td>±0.020</td> </tr> <tr> <td>1 PLACE</td> <td>±1.00</td> <td>±0.040</td> </tr> <tr> <td>0 PLACE</td> <td>±1.50</td> <td>±0.060</td> </tr> </tbody> </table>		mm	INCH	4 PLACES	±0.13	±0.005	3 PLACES	±0.25	±0.010	2 PLACES	±0.50	±0.020	1 PLACE	±1.00	±0.040	0 PLACE	±1.50	±0.060	DIMENSION STYLE MM ONLY	SCALE 5:1	DESIGN UNITS METRIC	THIRD ANGLE PROJECTION
		mm	INCH																					
	4 PLACES	±0.13	±0.005																					
	3 PLACES	±0.25	±0.010																					
2 PLACES	±0.50	±0.020																						
1 PLACE	±1.00	±0.040																						
0 PLACE	±1.50	±0.060																						
		ANGULAR $\pm 1^\circ$	DRAWN BY: JHATTON DATE: 2012/12/03	CHECKED BY: MMCKERVEY DATE: 2012/12/07	APPROVED BY: KLOYD DATE: 2012/12/20	TITLE SFP+ 1X4 CAGE, 3.05MM PRESS FIT, HEAT SINK, ELASTOMERIC GASKET																		
		DRAFT WHERE APPLICABLE MUST REMAIN WITHIN DIMENSIONS	MATERIAL NO. SEE SHEET 3	DOCUMENT NO. SD-111112-2410	SHEET NO. 5 OF 9	molex																		
			THIS DRAWING CONTAINS INFORMATION THAT IS PROPRIETARY TO MOLEX INCORPORATED AND SHOULD NOT BE USED WITHOUT WRITTEN PERMISSION																					

PCB LAYOUT FOR BELLY TO BELLY MOUNTING

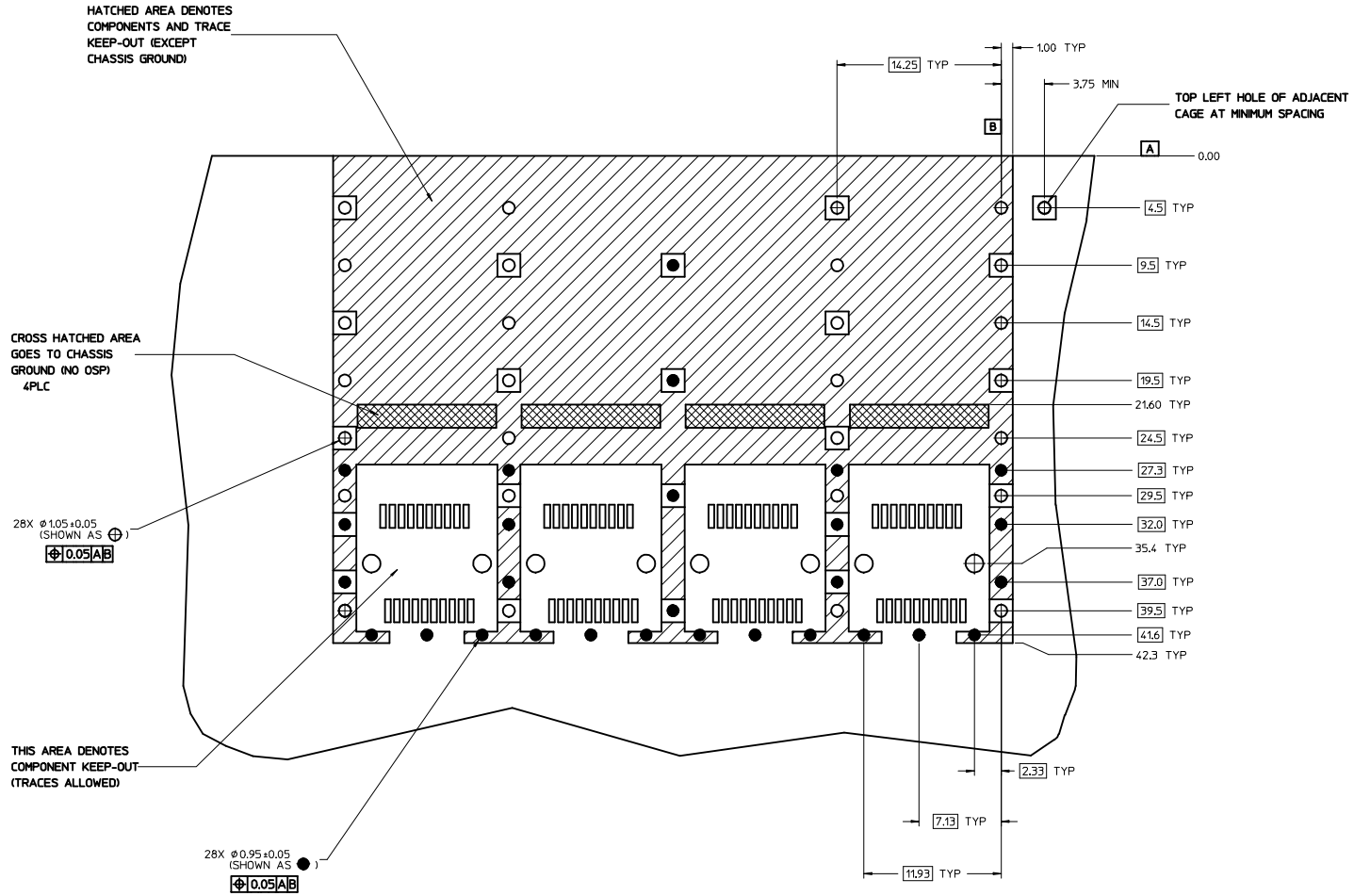

NOTE:
SEE SHEET 5 FOR HOST
CONNECTOR DETAIL

NOTES:

1. PADS AND VIAS CONNECT TO CHASSIS GROUND (RECOMMENDED PADS TO BE 2.00mm SQUARE)
2. RECOMMENDED THRU HOLE PLATING INCLUDES HASL, OSP, OR IMMERSION (GOLD, SILVER, OR TIN)
3. CONNECTOR PAD LAYOUT PER SFP+ MSA WILL ACCOMMODATE MOLEX CONNECTOR SERIES 74441 OR EQUIVALENT
4. HOLE PATTERN REPEATS FOR EACH PORT, SPACING BETWEEN PORTS IS 14.25mm
5. MINIMUM PCB THICKNESS FOR BELLY TO BELLY USE 3.00mm [0.118"].

SEE REVISION TABLE IEC NO: CPG2016-2975 DRAWN: ACHENG03 CHKD: APPR: RCHENG03 DATE: 2016/02/04	QUALITY SYMBOLS	GENERAL TOLERANCES (UNLESS SPECIFIED)	DIMENSION STYLE	SCALE	DESIGN UNITS	THIRD ANGLE PROJECTION
	▽=0	mm	MM ONLY	5:1	METRIC	☉
	▽=0	INCH				
	▽=0					
		4 PLACES ±---	DRAWN BY	DATE	TITLE	
		3 PLACES ±---	JHATTON	2012/12/03	SFP+ 1X4 CAGE, 3.05MM PRESS FIT, HEAT SINK, ELASTOMERIC GASKET	
		2 PLACES ±0.13	CHECKED BY	DATE	molex	
		1 PLACE ±0.25	MMCKERVEY	2012/12/07		
		0 PLACE ±---	APPROVED BY	DATE	DOCUMENT NO. SD-111112-2410	
			KLLOYD	2012/12/20		
		ANGULAR ± 1 °	MATERIAL NO.		SHEET NO.	
		DRAFT WHERE APPLICABLE MUST REMAIN WITHIN DIMENSIONS	SEE SHEET 3		6 OF 9	
			THIS DRAWING CONTAINS INFORMATION THAT IS PROPRIETARY TO MOLEX INCORPORATED AND SHOULD NOT BE USED WITHOUT WRITTEN PERMISSION			

POLYIMIDE INSULATOR COVERAGE AREA
(APPLIES TO SINGLE SIDED AND BELLY TO BELLY)

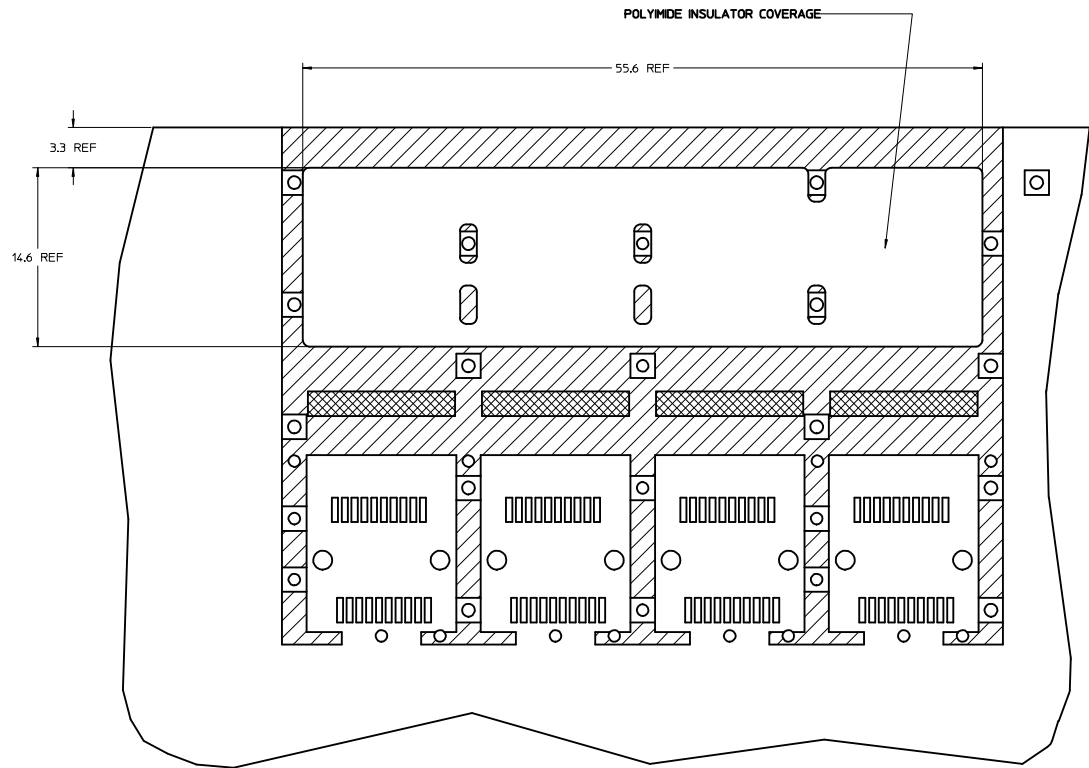

SEE REVISION TABLE IEC NO: CPG2016-2975 CHYD: DRWNA/CHENG03 APPROV: CHEN08 2016/02/04	QUALITY SYMBOLS	GENERAL TOLERANCES (UNLESS SPECIFIED)	DIMENSION STYLE	SCALE	DESIGN UNITS	THIRD ANGLE PROJECTION
	▽=0	mm INCH	MM ONLY	5:1	METRIC	
	▽=0	4 PLACES ± 0.13				
	▽=0	3 PLACES ± 0.25				
	DESCRIPTION	ANGULAR ± 1 °	DRAWN BY	DATE	TITLE	
		DRAFT WHERE APPLICABLE MUST REMAIN WITHIN DIMENSIONS	JHATTON	2012/12/03	SFP+ 1X4 CAGE, 3.05MM PRESS FIT, HEAT SINK, ELASTOMERIC GASKET	
			CHECKED BY	DATE	DOCUMENT NO.	
			MMCKERVEY	2012/12/07	SD-11112-2410	
			APPROVED BY	DATE	SHEET NO.	
			KLLOYD	2012/12/20	7 OF 9	
			MATERIAL NO.		THIS DRAWING CONTAINS INFORMATION THAT IS PROPRIETARY TO MOLEX INCORPORATED AND SHOULD NOT BE USED WITHOUT WRITTEN PERMISSION	
			SEE SHEET 3			

BEZEL AND BOARD POSITION DIMENSIONS FOR SINGLE SIDE MOUNTING
(ELASTOMERIC GASKET)

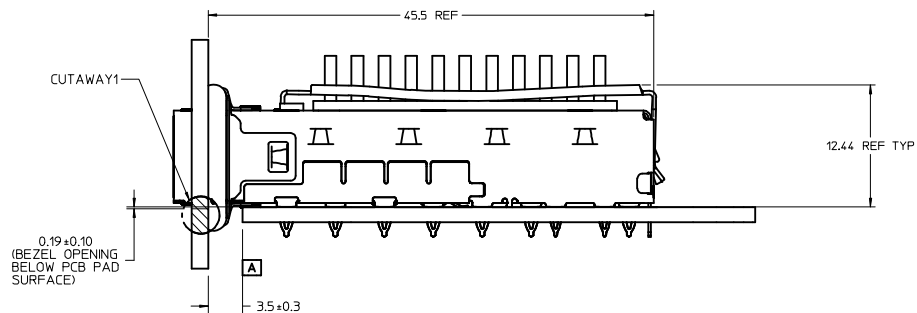
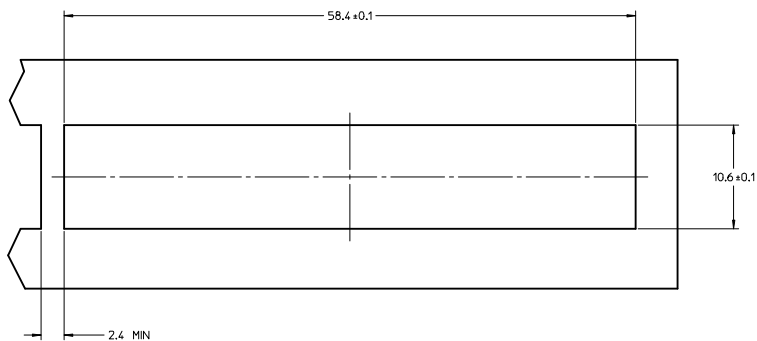

BEZEL AND BOARD POSITION DIMENSIONS FOR BELLY TO BELLY MOUNTING
(ELASTOMERIC GASKET)

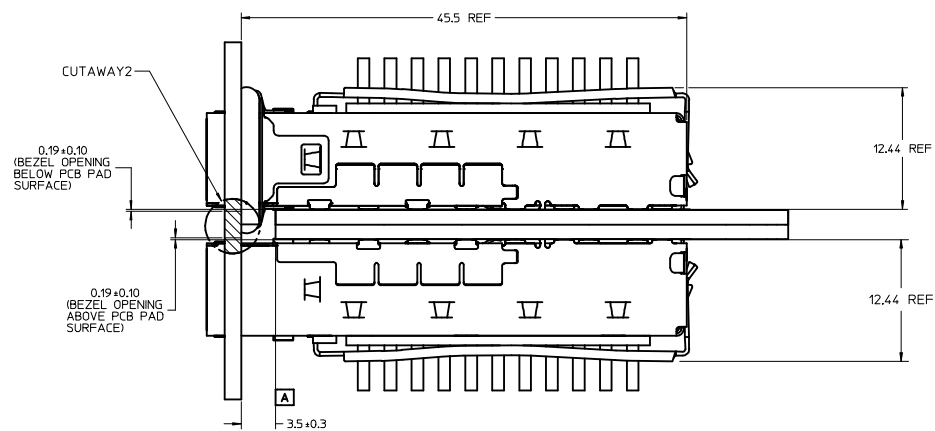
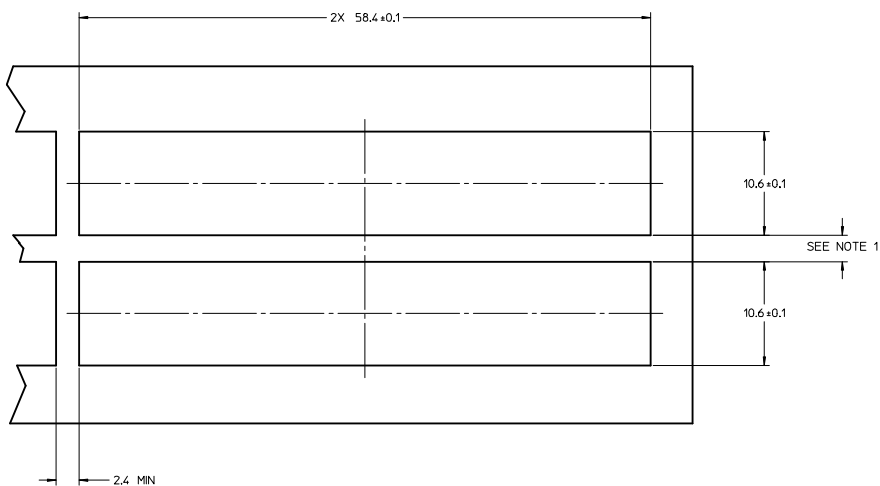

- NOTE:
- PCB THICKNESS VARIATION MUST BE CONSIDERED WHEN DETERMINING BEZEL OPENING LOCATION.
 - CAGE LEG STANDOFF WILL PIERCE BELLY GASKET WHEN PROPERLY PRESSED INTO PCB.

SEE REVISION TABLE EEC NO: CPG2016-2975 CHYD: DRWNA/CHENG03 APPROV: CHEN08 DATE: 2016/02/04	QUALITY SYMBOLS	GENERAL TOLERANCES (UNLESS SPECIFIED)	DIMENSION STYLE	SCALE	DESIGN UNITS	THIRD ANGLE PROJECTION
	▽=0	mm INCH	MM ONLY	4:1	METRIC	
	▽=0	4 PLACES ± --- # ---	DRAWN BY	TITLE		
	▽=0	3 PLACES ± --- # ---	JHATTON	SFP+ 1X4 CAGE, 3.05MM PRESS FIT, HEAT SINK, ELASTOMERIC GASKET		
	ANGULAR ± 1 °	DRAFT WHERE APPLICABLE MUST REMAIN WITHIN DIMENSIONS	CHECKED BY	MATERIAL NO.		
			MMCKERVEY	SEE SHEET 3		
			APPROVED BY	DOCUMENT NO.		
			KLLOYD	SD-111112-2410		
			DATE	SHEET NO.		
			2012/12/20	8 OF 9		
				THIS DRAWING CONTAINS INFORMATION THAT IS PROPRIETARY TO MOLEX INCORPORATED AND SHOULD NOT BE USED WITHOUT WRITTEN PERMISSION		

DATE	REV	DESCRIPTION
2012/12/03	A	1. INITIAL RELEASE
2013/01/23	B	1. REMOVED EMI GASKET FROM TOP, @I16, AND RIGHT SIDE, @E12, VIEWS FOR CLARITY. ADDED EMI GASKET UNCOMPRESSED OVERALL DIMENSIONS TO FRONT VIEW, @E16. ADDED 9.98 REF DIM. TO SIDE VIEW. ADDED BACK VIEW W/INNER WALL WELD NOTE, @E3. REMOVED BELLY ISO VIEW CHANGED ALL VIEWS ON SHEET 1 TO 747540410 CLOSED TOP BASE CAGE. MOVED MIN PCB THICKNESS NOTE TO RESPECTIVE PCB LAYOUT SHEETS. REMOVED INSERTION FORCE FROM NOTE 2. UPDATED PN/DATE CODE PRINTING CALLOUT ON SIDE VIEW. ADDED FIX TEXT OVERALL LENGTH TO DIM. 49.0 REF @J14. ADDED APPLICATION NOTE @M10. ADDED TYP TO DIMENSION 3.05 REF ON SIDE VIEW @E8 (SHEET 1). 2. ADDED 'REAR LEG OPTIONS' SECTION, @B16. REMOVED CAGES FROM HEATSINK OPTIONS VIEWS & UPDATED TABLES, @J2, J6 & J11. MOVED BELLY VIEW TO, D9. ADDED BELLY VIEW @D3. ADDED OPEN TOP VIEW @17. ADDED OVERALL HEATSINK NOTE TO TABLES @12, 16, & 111. ADDED ▽ & ▽ TO ISO BELLY VIEW @D3. (SHEET 2). 3. ADDED PN'S 747540410, 747540411, 747540415, 747540419 & 1111110410 ADDING VIEWS AND PN TABLES. ADDED # OF REAR LEGS PER PORT COLUMN TO TABLES. (SHEET 3) 4. REMOVED BASIC TOLERANCE FROM DIMENSION 35.4 TYP, @F8. ADDED MIN PCB THICKNESS NOTE. ADDED DIAMETER DIMENSION Ø0.95 ± 0.05 X4 @D15. MOVED TYP FROM DIMENSION BOXES. ADDED DATUM A & DATUM B. ADDED NOTES 1 THRU 4. (SHEET 4) 5. REMOVED BASIC TOLERANCE FROM DIMENSION 35.4 TYP, @F5. ADDED MIN PCB THICKNESS NOTE. REMOVED PAD @F14. ADDED NOTES 1 THRU 4. (SHEET 5). 6. REMOVED BELLY TO BELLY PCB VIEW, CENTERED SINGLE SIDED VIEW AND ADDED APPLICATION NOTE TO SHEET TITLE. REMOVED DIMENSION 1.7 REF (SHEET 6) 7. CHANGED TOLERANCE ON DIMENSIONS 0.19 TO 0.19 ±0.10, @D9 & F9. ADDED CENTER LINES TO BEZELS. REMOVED 'CUTAWAY'S FROM SIDE VIEWS. REMOVED 'SEE NOTE 1' FROM 10.6 ±0.1 BEZEL OPENING SIZE DIMENSIONS @D10 & E10. REMOVED 'SIZE, AND' FROM NOTE 1. ADDED 'SEE NOTE 1' TO BELLY TO BELLY BEZEL OPENING PITCH. (SHEET 7) 8. MOVED NOTES TO BOTTOM LEFT CORNER AND INCREASED TEXT HEIGHT, (SHEETS 1, 4, 5 & 7). CHANGED DRAWING DIMENSION STYLE TO MM ONLY. CHANGED THE GENERAL ANGLE TOLERANCE TO 1° FOR ALL SHEETS.
2014/02/05	C	1. MOVED DATE CODE FROM VIEW @E9 TO VIEW @E5. REVISED NOTE 4 'WAS' WELD SPOT WILL SHOW SLIGHT MATERIAL DISCOLORATION. 'NOW READS' WELD SPOT MAY SHOW SLIGHT MATERIAL DISCOLORATION SHEET 1. 2. MOVED VIEW @E4 SHEET 2 TO THE REVISED SHEET 3 @K4. ADDED VIEW AND DATE CODE @E5. 3. ADDED NEW SHEET 3: PREVIOUS SHEET 3-8 INCREASED BY ONE NUMBER. ADDED NOTE 1 @A20. REMOVED NOTE FROM ISO VIEW @16. 4. ADDED VIEW @F8 AND REVISED PART NUMBER 'WAS' 747540410. 'NOW READS' 1111110410 @G12 SHEET 4.
2014/05/12	D	1. ADDED P/N 74754-0470 [SHEET 4]
2014/09/09	E	1. ADDED P/N 100114-4410. [SHEET 4]
2015/07/16	F	1. REVISED COLUMN LABEL UL RATING TO FLAMMABILTY RATING IN TABLE @D7. 2. REVISED PART NO. 100114-4410 NOTES @D7 'WAS' UL TESTING PENDING. 'NOW' UL94 V-0. SHEET 4 3. ADDED NOTE 2 @A20. SHEET 8
2015/10/26	G	SHEET 1: A19: ADDED NOTE *7. MOST OF P/N ARE WITH 14.05 REF EXCEPT 747540415 & 747540419 ARE 12.55 REF*. E12: CHANGED '14.05 REF (ACROSS FRAME)' TO 'SEE NOTE 7. (ACROSS FRAME)'.
2016/02/03	H	1. SHEET 3 & 4: REMOVE 1111110410.

SEE REVISION TABLE EEC NO: CPG2016-2975 DRAWN BY: DRWACHENG03 CHKD: APPR:RCHENG08 DATE: 2016/02/04	QUALITY SYMBOLS	GENERAL TOLERANCES (UNLESS SPECIFIED)	DIMENSION STYLE	SCALE	DESIGN UNITS	THIRD ANGLE PROJECTION
	▽=0	4 PLACES ±--- ±---	MM ONLY	1:1	METRIC	TITLE: SFP+ 1X4 CAGE, 3.05MM PRESS FIT, HEAT SINK, ELASTOMERIC GASKET molex MATERIAL NO. SD-111112-2410 DOCUMENT NO. SD-111112-2410 SHEET NO. 9 OF 9
	▽=0	3 PLACES ±--- ±---	mm			
	▽=0	2 PLACES ±0.13 ±---	INCH			
▽=0	1 PLACE ±0.25 ±---					
		0 PLACE ±--- ±---				
		ANGULAR ± 1 °				
		DRAFT WHERE APPLICABLE MUST REMAIN WITHIN DIMENSIONS	SEE SHEET 3			
			THIS DRAWING CONTAINS INFORMATION THAT IS PROPRIETARY TO MOLEX INCORPORATED AND SHOULD NOT BE USED WITHOUT WRITTEN PERMISSION			

BASE CAGE DETAILS

(APPLIES TO ALL CAGES IN THIS DRAWING)

747540410
SHOWN

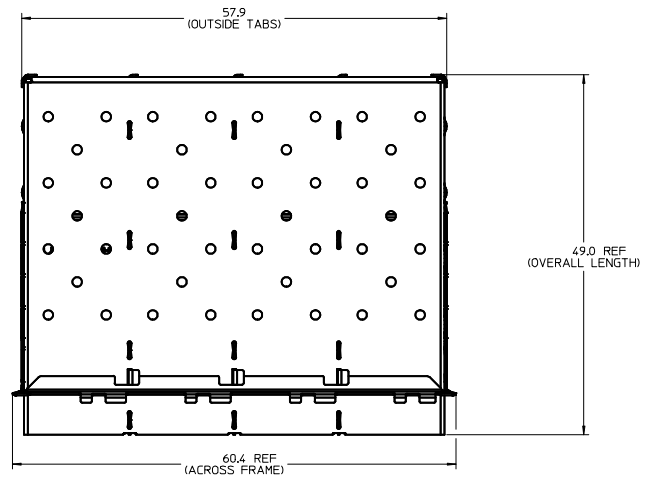

NOTE:
EMI GASKET REMOVED FROM THIS VIEW FOR CLARITY.

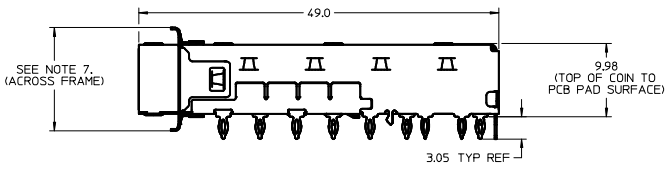
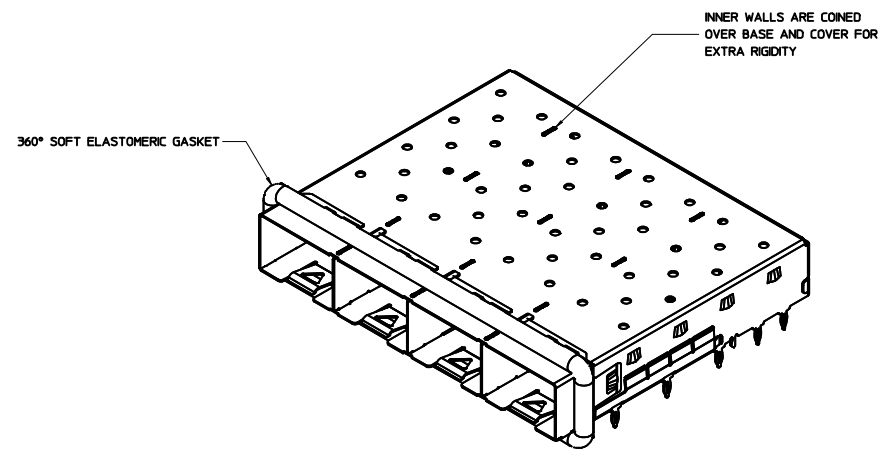
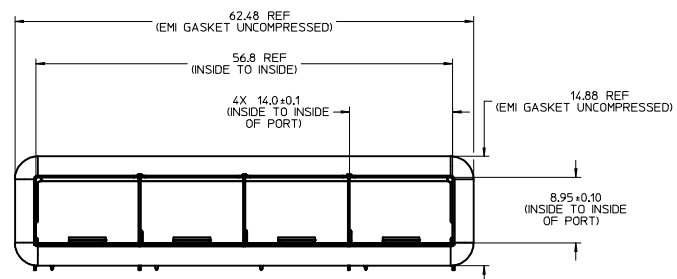

NOTE:
EMI GASKET REMOVED FROM THIS VIEW FOR CLARITY.

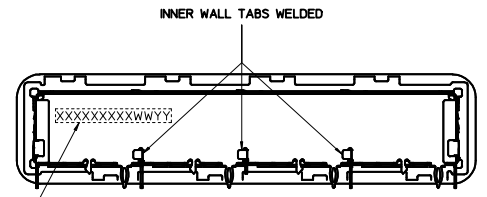

WEEK/YEAR DATE CODE TABLE	
WW	01 THRU 52 OR 53 EXAMPLE: 01 = FIRST WEEK OF YEAR 52 = LAST WEEK OF YEAR
YY	15, 16, 17 ETC. EXAMPLE: YEAR 2015 = 15

NOTES:

1. MATERIAL:
 CAGE: 0.25mm THICK COPPER ALLOY, NICKEL PLATED.
 SPRING FINGERS: 0.10mm THICK COPPER ALLOY, NICKEL PLATED.
 HEATSINK: ALUMINUM, NICKEL PLATED.
 HEATSINK SPRING CLIP: STAINLESS STEEL.
2. PRESS FIT LEGS 3.05mm (.120 INCH) LONG;
3. PORTS ARE DESIGNED FOR SFP+ TRANSCEIVERS AND ARE COMPATIBLE WITH SFP TRANSCEIVERS.
 THE TOP SURFACE OF THE MODULE MUST BE FLAT (NO PRODUCT LABEL RECESS) AND THERMALLY CONDUCTIVE TO FUNCTION OPTIMALLY.
4. WELD SPOT MAY SHOW SLIGHT MATERIAL DISCOLORATION.
5. NO ROHS EXEMPTIONS.
6. CUSTOM HEATSINKS AVAILABLE UPON REQUEST.
7. MOST OF P/N ARE WITH 14.05 REF EXCEPT 747540415 & 747540419 ARE 12.55 REF.

SEE REVISION TABLE	QUALITY SYMBOLS	GENERAL TOLERANCES (UNLESS SPECIFIED)	DIMENSION STYLE	SCALE	DESIGN UNITS	THIRD ANGLE PROJECTION
IEC NO: CPG2016-2975 DRAWN BY: JHATTON CHYK: MCKKERVEY APPR: KLLLOYD DESCRIPTION: SFP+ 1X4 CAGE, 3.05MM PRESS FIT, HEAT SINK, ELASTOMERIC GASKET DATE: 2016/02/04	∇=0 ∇=0 ∇=0	mm INCH 4 PLACES ± --- ± --- 3 PLACES ± --- ± --- 2 PLACES ± 0.13 ± --- 1 PLACE ± 0.25 ± --- 0 PLACE ± --- ± --- ANGULAR ± 1 ° DRAFT WHERE APPLICABLE MUST REMAIN WITHIN DIMENSIONS	MM ONLY DRAWN BY: JHATTON CHECKED BY: MCKKERVEY APPROVED BY: KLLLOYD DATE: 2012/12/03 DATE: 2012/12/07 DATE: 2012/12/20	3:1	METRIC	TITLE: SFP+ 1X4 CAGE, 3.05MM PRESS FIT, HEAT SINK, ELASTOMERIC GASKET MATERIAL NO: SEE SHEET 3 DOCUMENT NO: SD-111112-2410 SHEET NO: 1 OF 9

CAGE ASSEMBLY OPTIONS

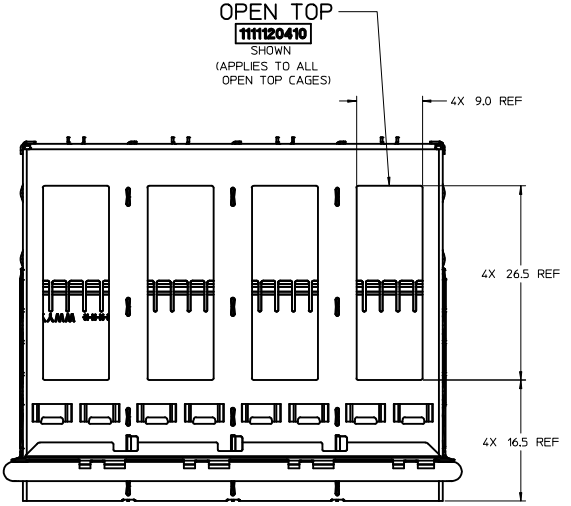

HEATSINK OPTIONS

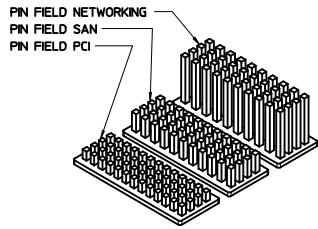

OVERALL HEATSINK HEIGHT

APPLICATION	DIM 'A'
PCI	14.3
SAN	16.6
NETWORKING	23.6

NOTE: PCI - 13 ROWS
SAN - 11 ROWS
NETWORKING - 10 ROWS

HEATSINK OPTIONS

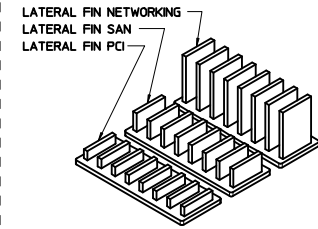

OVERALL HEATSINK HEIGHT

APPLICATION	DIM 'A'
PCI	14.3
SAN	16.6
NETWORKING	23.6

HEATSINK OPTIONS

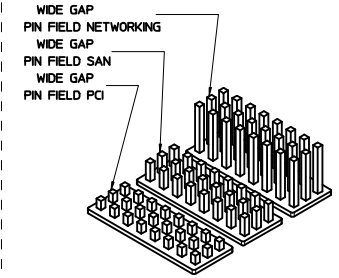

OVERALL HEATSINK HEIGHT

APPLICATION	DIM 'A'
PCI	14.3
SAN	16.6
NETWORKING	23.6

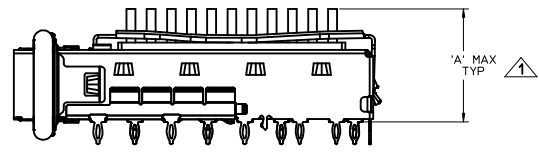

NOTES:
▲ HEIGHT OF HEATSINK WITH MODULE INSERTED.
DIMENSION MAY BE LESS DUE TO MODULE AND HEATSINK VARIATIONS.

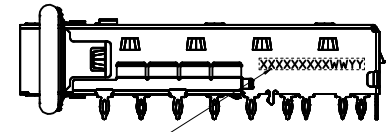
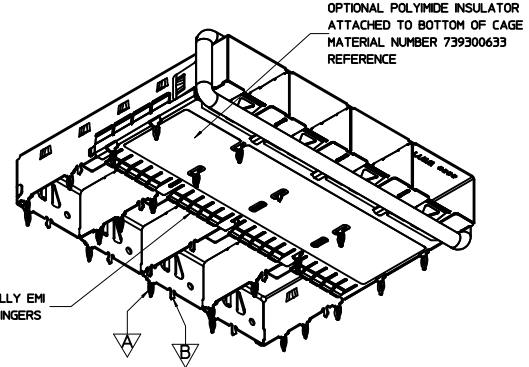

PART NO. AND WEEK/YEAR DATE CODE TO BE PRINTED ON BACK OF COMPLETED CAGE ASSEMBLY APPROXIMATELY AS SHOWN. SEE TABLE BELOW FOR DATE CODE INFORMATION.

WEEK/YEAR DATE CODE TABLE	
WW	01 THRU 52 OR 53 EXAMPLE: 01 = FIRST WEEK OF YEAR 52 = LAST WEEK OF YEAR
YY	15, 16, 17 ETC. EXAMPLE: YEAR 2015 = '15

REAR LEG OPTIONS (PER PORT)

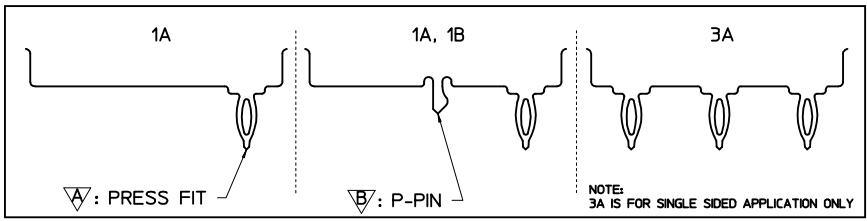

SEE REVISION TABLE EC NO: CPG2016-2975 CHKS: DRAWN:ACHENGO3 APPR:CHEN08 2016/02/04	QUALITY SYMBOLS ∇=0 ∇=0 ∇=0	GENERAL TOLERANCES (UNLESS SPECIFIED) mm INCH 4 PLACES ±--- ±--- 3 PLACES ±--- ±--- 2 PLACES ±0.13 ±--- 1 PLACE ±0.25 ±--- 0 PLACE ±--- ±---	DIMENSION STYLE MM ONLY SCALE 3:1 DESIGN UNITS METRIC THIRD ANGLE PROJECTION	DRAWN BY DATE JHATTON 2012/12/03 CHECKED BY DATE MCKERVEY 2012/12/07 APPROVED BY DATE KLOYD 2012/12/20	TITLE SFP+ 1X4 CAGE, 3.05MM PRESS FIT, HEAT SINK, ELASTOMERIC GASKET molex MATERIAL NO. SD-11112-2410 DOCUMENT NO. SD-11112-2410 SHEET NO. 2 OF 9
	DRAFT WHERE APPLICABLE MUST REMAIN WITHIN DIMENSIONS				
	SEE SHEET 3				
	THIS DRAWING CONTAINS INFORMATION THAT IS PROPRIETARY TO MOLEX INCORPORATED AND SHOULD NOT BE USED WITHOUT WRITTEN PERMISSION				

OPTIONAL GEN 2 UNDER BELLY GASKET

100114-0410

SHOWN

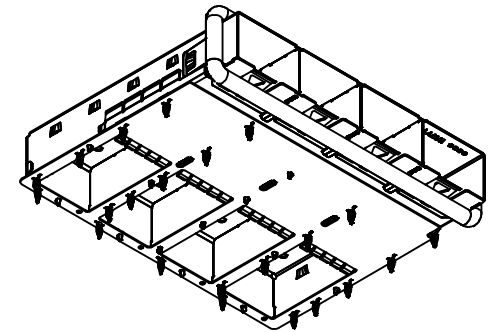
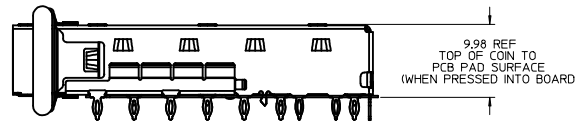
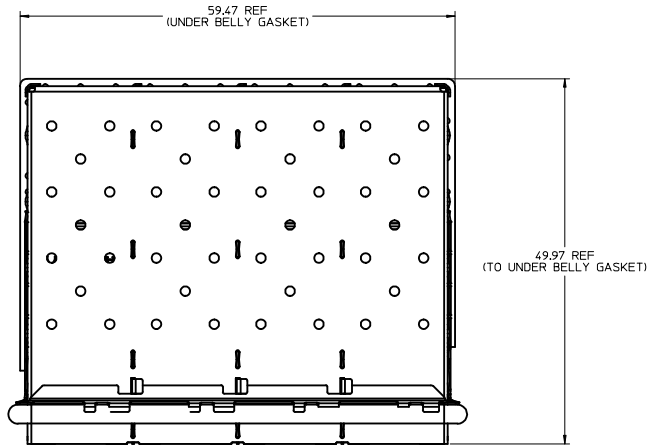

1. OPTIONAL UNDER BELLY GASKET ATTACHED TO BOTTOM OF CAGE (SEE P/N TABLES FOR AVAILABLE ASSEMBLIES)

ENTER DESCRIPTION IEC NO: CPG2016-2975 CHYD: CHYD03 APPR: RCHEN08 2016/02/04	QUALITY SYMBOLS	GENERAL TOLERANCES (UNLESS SPECIFIED)		DIMENSION STYLE	SCALE	DESIGN UNITS	THIRD ANGLE PROJECTION
	▽=0	4 PLACES	mm INCH	MM ONLY	3:1	METRIC	☉
	▽=0	3 PLACES					
	▽=0	2 PLACES					
		ANGULAR ± 1°					
		DRAFT WHERE APPLICABLE MUST REMAIN WITHIN DIMENSIONS					
				MATERIAL NO.	DOCUMENT NO.		SHEET NO.
				SEE TABLE	SD-111112-2410		3 OF 9
				THIS DRAWING CONTAINS INFORMATION THAT IS PROPRIETARY TO MOLEX INCORPORATED AND SHOULD NOT BE USED WITHOUT WRITTEN PERMISSION			

PART NUMBER SELECTION

1111120410
SHOWN

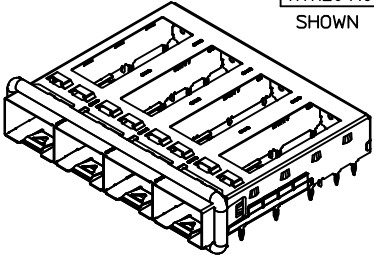

1111122410
SHOWN

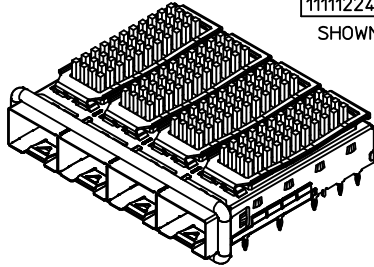

1111125410
SHOWN

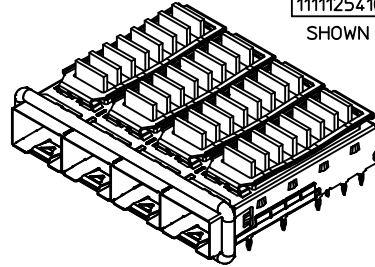

1111128410
SHOWN

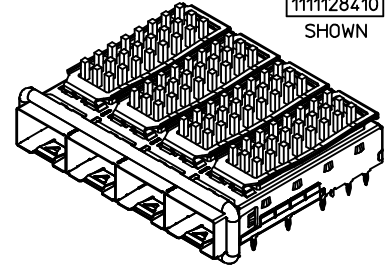

OPEN TOP BASE CAGE FOR HEATSINK		
PART NO.	POLYIMIDE INSULATOR	# OF REAR LEGS PER PORT
1111120410	---	1A, 1B
1111120450	YES	1A, 1B

PIN FIELD HEATSINK OPTION			
PART NO.	POLYIMIDE INSULATOR	HEATSINK	# OF REAR LEGS PER PORT
1111121410	---	PCI	1A, 1B
1111121450	YES	PCI	1A, 1B
1111122410	---	SAN	1A, 1B
1111122450	YES	SAN	1A, 1B
1111123410	---	NET	1A, 1B
1111123450	YES	NET	1A, 1B

NOTE: PCI - 13 ROWS
SAN - 11 ROWS
NET - 10 ROWS

LATERAL FIN HEATSINK OPTION			
PART NO.	POLYIMIDE INSULATOR	HEATSINK	# OF REAR LEGS PER PORT
1111124410	---	PCI	1A, 1B
1111124450	YES	PCI	1A, 1B
1111125410	---	SAN	1A, 1B
1111125450	YES	SAN	1A, 1B
1111126410	---	NET	1A, 1B
1111126450	YES	NET	1A, 1B

WIDE GAP PIN FIELD HEATSINK OPTION			
PART NO.	POLYIMIDE INSULATOR	HEATSINK	# OF REAR LEGS PER PORT
1111127410	---	PCI	1A, 1B
1111127450	YES	PCI	1A, 1B
1111128410	---	SAN	1A, 1B
1111128450	YES	SAN	1A, 1B
1111129410	---	NET	1A, 1B
1111129450	YES	NET	1A, 1B

747540410
SHOWN

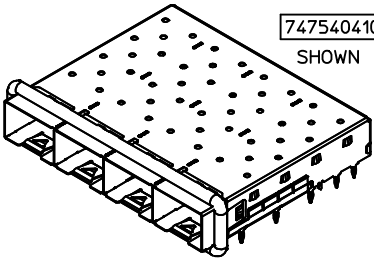

1001140410
SHOWN

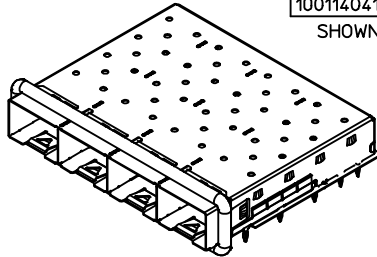

SFP+ CLOSED TOP BASE CAGE			
PART NO.	POLYIMIDE INSULATOR	# OF REAR LEGS PER PORT	ELASTOMERIC GASKET FLAMMABILITY RATING
747540410	---	1A, 1B	
747540411	---	3A	
747540415	---	1A, 1B	
747540419	---	1A, 1B	
747540470	---	1A, 1B	EQUATE TO UL94 V-0

zSFP+ CLOSED TOP BASE CAGE W/ GEN 2 BELLY GASKET		
PART NO.	# OF REAR LEGS PER PORT	FLAMMABILITY RATING
1001140410	1A, 1B	N/A
1001144410	1A, 1B	UL94 V-0

SEE REVISION TABLE EC NO: CPG2016-2975 DRAWN: CHENG03 CHKD: APPR: CHEN08 2016/02/04	QUALITY SYMBOLS ▽=0 ▽=0 ▽=0	GENERAL TOLERANCES (UNLESS SPECIFIED) mm INCH		DIMENSION STYLE MM ONLY	SCALE 2:1	DESIGN UNITS METRIC	THIRD ANGLE PROJECTION	
		4 PLACES ±0.13 ±0.005 3 PLACES ±0.25 ±0.010 2 PLACES ±0.38 ±0.015 1 PLACE ±0.51 ±0.020 0 PLACE ±0.64 ±0.025		DRAWN BY: JHATTON DATE: 2012/12/03 CHECKED BY: MCKERVEY DATE: 2012/12/07 APPROVED BY: K LLOYD DATE: 2012/12/20		TITLE SFP+ 1X4 CAGE, 3.05MM PRESS FIT, HEAT SINK, ELASTOMERIC GASKET		
		ANGULAR ± 1 ° DRAFT WHERE APPLICABLE MUST REMAIN WITHIN DIMENSIONS		MATERIAL NO. SEE TABLE		DOCUMENT NO. SD-11112-2410		
				SIZE THIS DRAWING CONTAINS INFORMATION THAT IS PROPRIETARY TO MOLEX INCORPORATED AND SHOULD NOT BE USED WITHOUT WRITTEN PERMISSION		SHEET NO. 4 OF 9		

PCB LAYOUT FOR SINGLE SIDE MOUNT

HATCHED AREA DENOTES COMPONENTS AND TRACE KEEP-OUT (EXCEPT CHASSIS GROUND)

CROSS HATCHED AREA GOES TO CHASSIS GROUND (NO OSP) 4 PLCS

14X $\phi 1.05 \pm 0.05$ (SHOWN AS \oplus)
 $\oplus 0.05 \text{ AB}$

THIS AREA DENOTES COMPONENT KEEP-OUT (TRACES ALLOWED)

20X $\phi 0.95 \pm 0.05$ (SHOWN AS \bullet)
 $\bullet 0.05 \text{ AB}$

4X $\phi 0.95 \pm 0.05$ (SHOWN AS \oplus)
 $\oplus 0.05 \text{ AB}$
 OPTIONAL HOLES FOR CAGES WITH 3 REAR LEGS PER PORT

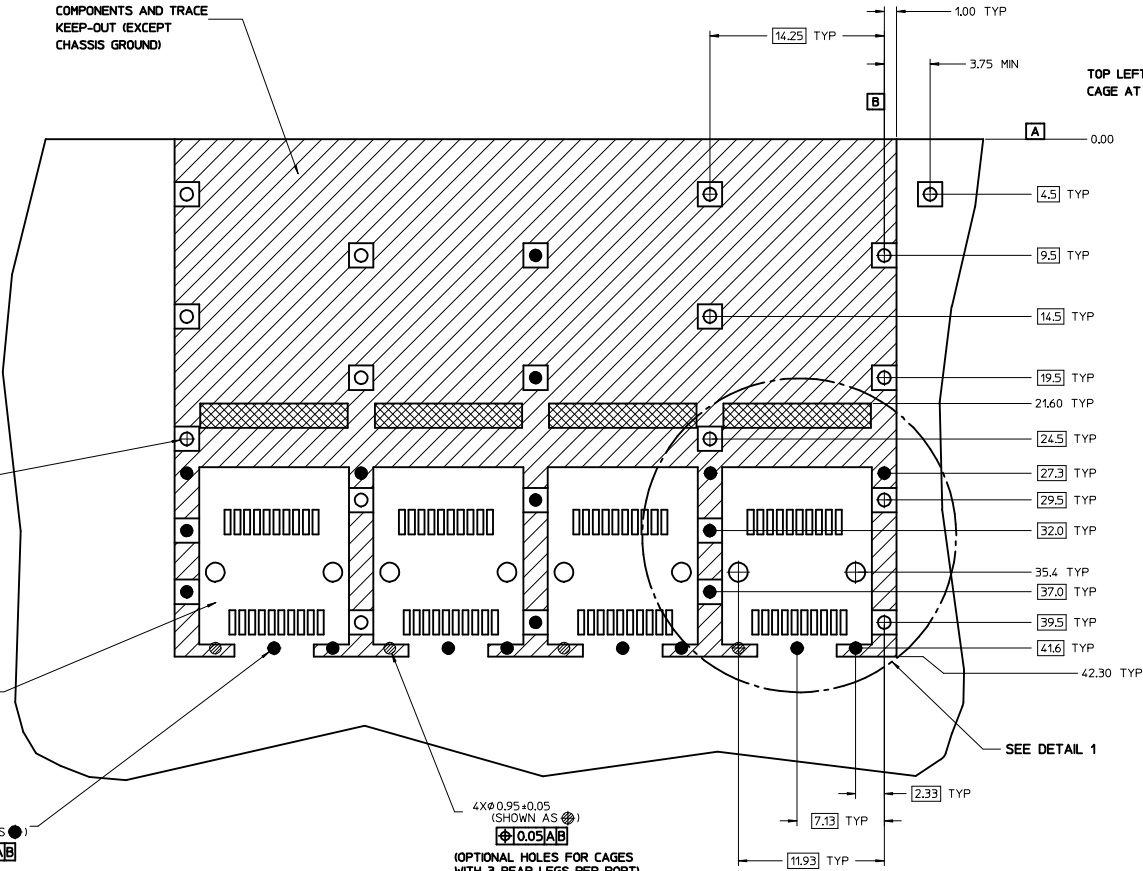

HOST CONNECTOR DETAIL

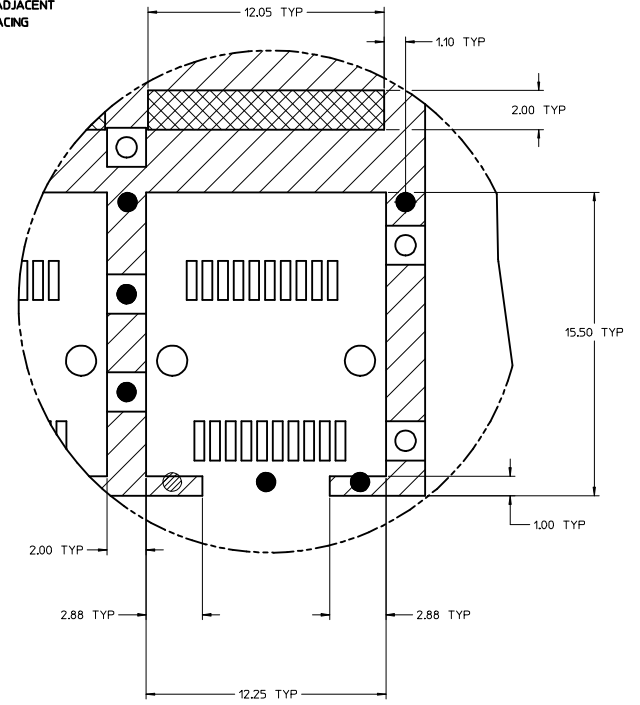

DETAIL 1
SCALE 8:1

NOTES:

1. PADS AND VIAS CONNECT TO CHASSIS GROUND (RECOMMENDED PADS TO BE 2.00mm SQUARE)
2. RECOMMENDED THRU HOLE PLATING INCLUDES HASL, OSP, OR IMMERSION (GOLD, SILVER, OR TIN)
3. CONNECTOR PAD LAYOUT PER SFP+ MSA WILL ACCOMMODATE MOLEX CONNECTOR SERIES 74441 OR EQUIVALENT
4. HOLE PATTERN REPEATS FOR EACH PORT, SPACING BETWEEN PORTS IS 14.25mm
5. MINIMUM PCB THICKNESS FOR SINGLE SIDED USE 157mm [0.062"].

SEE REVISION TABLE EC NO: CPG2016-2975 DRAWN BY: JHATTON CHECKED BY: MMCKERVEY APPROVED BY: KLOYD DATE: 2016/02/03 DATE: 2012/12/03 DATE: 2012/12/07 DATE: 2012/12/20	QUALITY SYMBOLS $\nabla=0$ $\nabla=0$ $\nabla=0$	GENERAL TOLERANCES (UNLESS SPECIFIED) <table border="1"> <thead> <tr> <th></th> <th>mm</th> <th>INCH</th> </tr> </thead> <tbody> <tr> <td>4 PLACES</td> <td>±0.13</td> <td>±---</td> </tr> <tr> <td>3 PLACES</td> <td>±0.25</td> <td>±---</td> </tr> <tr> <td>2 PLACES</td> <td>±0.50</td> <td>±---</td> </tr> <tr> <td>1 PLACE</td> <td>±1.00</td> <td>±---</td> </tr> <tr> <td>0 PLACE</td> <td>±---</td> <td>±---</td> </tr> </tbody> </table>		mm	INCH	4 PLACES	±0.13	±---	3 PLACES	±0.25	±---	2 PLACES	±0.50	±---	1 PLACE	±1.00	±---	0 PLACE	±---	±---	DIMENSION STYLE MM ONLY	SCALE 5:1	DESIGN UNITS METRIC	THIRD ANGLE PROJECTION
		mm	INCH																					
	4 PLACES	±0.13	±---																					
	3 PLACES	±0.25	±---																					
2 PLACES	±0.50	±---																						
1 PLACE	±1.00	±---																						
0 PLACE	±---	±---																						
	ANGULAR $\pm 1^\circ$ DRAFT WHERE APPLICABLE MUST REMAIN WITHIN DIMENSIONS	DRAWN BY: JHATTON CHECKED BY: MMCKERVEY APPROVED BY: KLOYD DATE: 2012/12/03 DATE: 2012/12/07 DATE: 2012/12/20	MATERIAL NO. SEE SHEET 3	TITLE SFP+ 1X4 CAGE, 3.05MM PRESS FIT, HEAT SINK, ELASTOMERIC GASKET	DOCUMENT NO. SD-111112-2410	SHEET NO. 5 OF 9																		
			SIZE D	THIS DRAWING CONTAINS INFORMATION THAT IS PROPRIETARY TO MOLEX INCORPORATED AND SHOULD NOT BE USED WITHOUT WRITTEN PERMISSION																				

PCB LAYOUT FOR BELLY TO BELLY MOUNTING

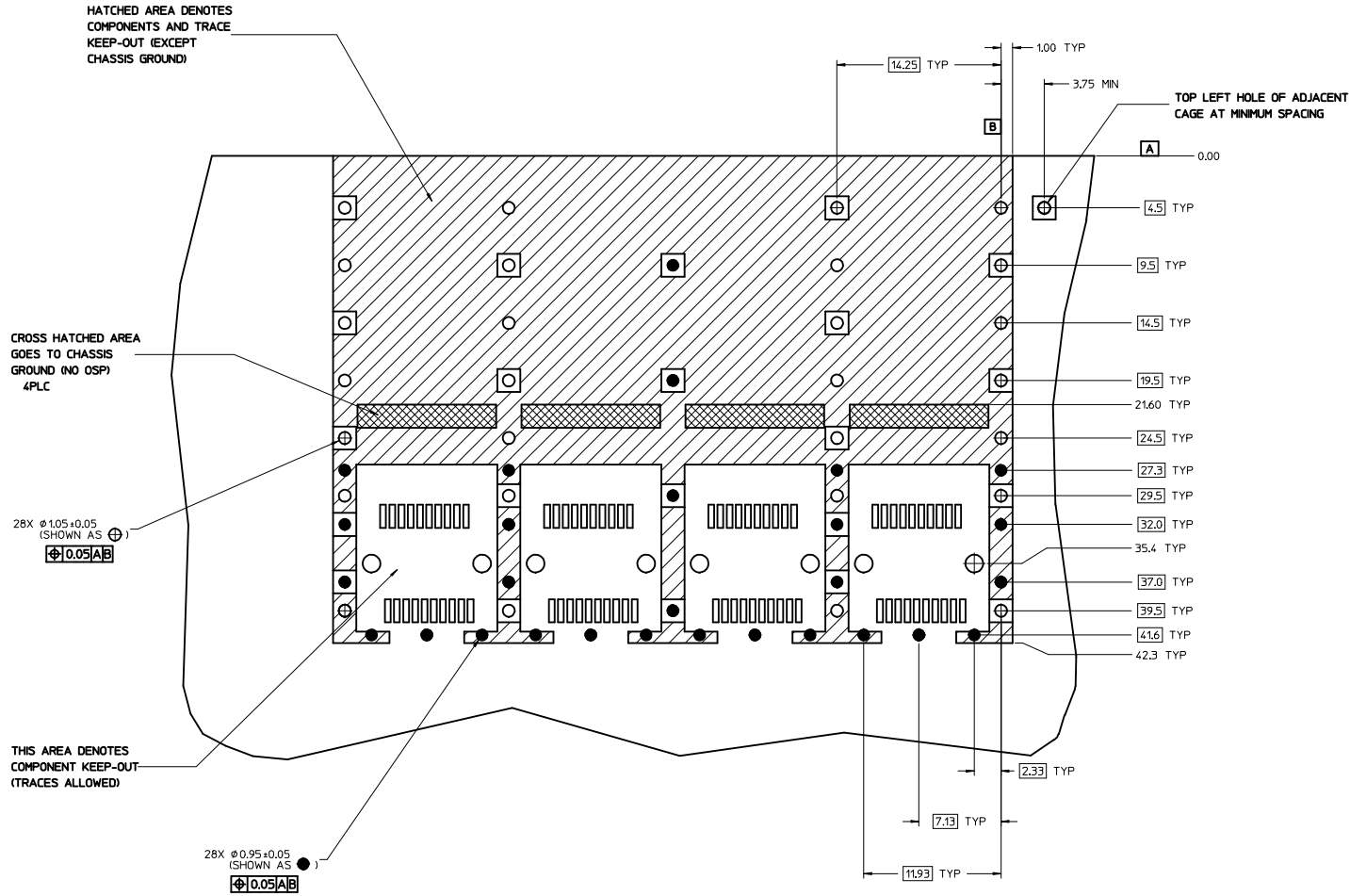

NOTES:

1. PADS AND VIAS CONNECT TO CHASSIS GROUND (RECOMMENDED PADS TO BE 2.00mm SQUARE)
2. RECOMMENDED THRU HOLE PLATING INCLUDES HASL, OSP, OR IMMERSION (GOLD, SILVER, OR TIN)
3. CONNECTOR PAD LAYOUT PER SFP+ MSA WILL ACCOMMODATE MOLEX CONNECTOR SERIES 74441 OR EQUIVALENT
4. HOLE PATTERN REPEATS FOR EACH PORT, SPACING BETWEEN PORTS IS 14.25mm
5. MINIMUM PCB THICKNESS FOR BELLY TO BELLY USE 3.00mm [0.118"].

SEE REVISION TABLE IEC NO: CPG2016-2975 DRAWN: ACHENG03 CHKD: APPROVED:	2016/02/08 2016/02/08 2016/02/08	QUALITY SYMBOLS ∇=0 ∇=0 ∇=0	GENERAL TOLERANCES (UNLESS SPECIFIED) mm INCH 4 PLACES ±--- ±--- 3 PLACES ±--- ±--- 2 PLACES ±0.13 ±--- 1 PLACE ±0.25 ±--- 0 PLACE ±--- ±---	DIMENSION STYLE MM ONLY SCALE 5:1 DESIGN UNITS METRIC THIRD ANGLE PROJECTION	DRAWN BY JHATTON DATE 2012/12/03 CHECKED BY DATE MCKERVEY 2012/12/07 APPROVED BY DATE KLOYD 2012/12/20	TITLE SFP+ 1X4 CAGE, 3.05MM PRESS FIT, HEAT SINK, ELASTOMERIC GASKET molex MATERIAL NO. SEE SHEET 3 DOCUMENT NO. SD-111112-2410	SHEET NO. 6 OF 9
	DRAFT WHERE APPLICABLE MUST REMAIN WITHIN DIMENSIONS			ANGULAR ± 1 °		THIS DRAWING CONTAINS INFORMATION THAT IS PROPRIETARY TO MOLEX INCORPORATED AND SHOULD NOT BE USED WITHOUT WRITTEN PERMISSION	

POLYIMIDE INSULATOR COVERAGE AREA
(APPLIES TO SINGLE SIDED AND BELLY TO BELLY)

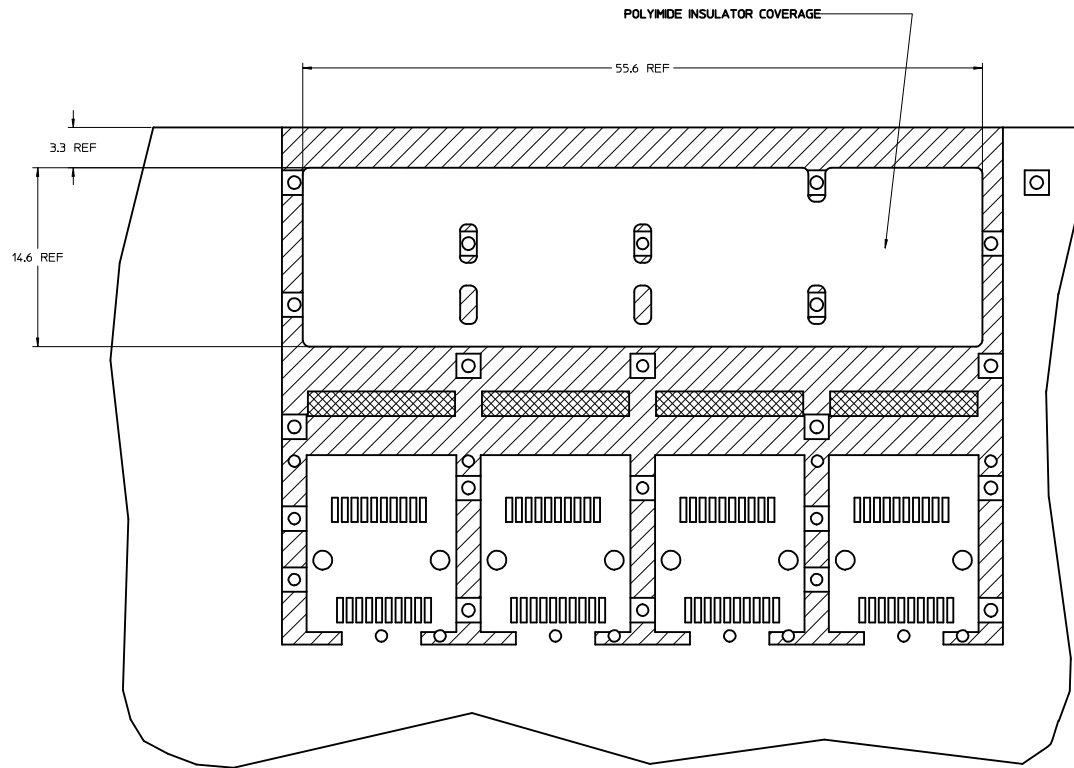

SEE REVISION TABLE EEC NO: CPG2016-2975 CHYD: DRWNAACHENG03 APPROV: APPRCHENG08	2016/02/03 2016/02/04	QUALITY SYMBOLS ∇=0 ∇=0 ∇=0	GENERAL TOLERANCES (UNLESS SPECIFIED) mm INCH 4 PLACES ± --- ± --- 3 PLACES ± --- ± --- 2 PLACES ± 0.13 ± --- 1 PLACE ± 0.25 ± --- 0 PLACE ± --- ± ---	DIMENSION STYLE MM ONLY	SCALE 5:1	DESIGN UNITS METRIC	THIRD ANGLE PROJECTION	
	DRAWN BY JHATTON	DATE 2012/12/03	CHECKED BY MMCKERVEY	DATE 2012/12/07	APPROVED BY KLLLOYD	DATE 2012/12/20	TITLE SFP+ 1X4 CAGE, 3.05MM PRESS FIT, HEAT SINK, ELASTOMERIC GASKET	MATERIAL NO. SEE SHEET 3
	ANGULAR ± 1 ° DRAFT WHERE APPLICABLE MUST REMAIN WITHIN DIMENSIONS	DOCUMENT NO. SD-11112-2410	SHEET NO. 7 OF 9	THIS DRAWING CONTAINS INFORMATION THAT IS PROPRIETARY TO MOLEX INCORPORATED AND SHOULD NOT BE USED WITHOUT WRITTEN PERMISSION				
	SEE SHEET 3							

BEZEL AND BOARD POSITION DIMENSIONS FOR SINGLE SIDE MOUNTING
(ELASTOMERIC GASKET)

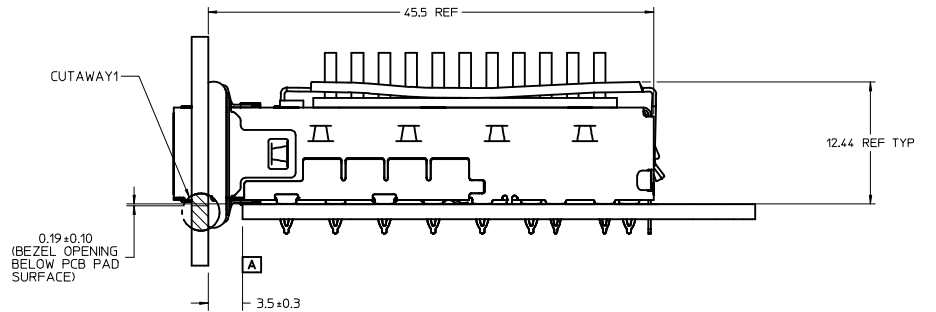
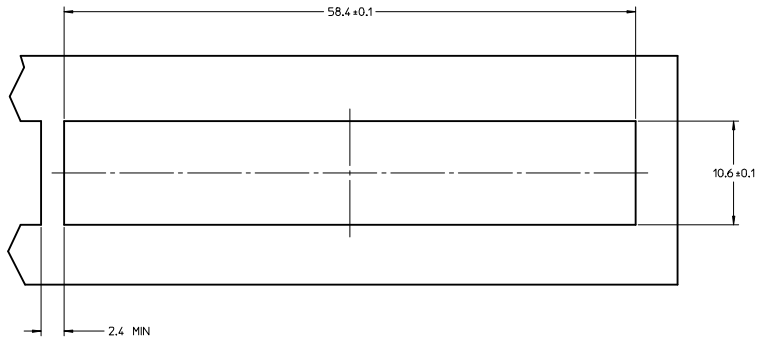

BEZEL AND BOARD POSITION DIMENSIONS FOR BELLY TO BELLY MOUNTING
(ELASTOMERIC GASKET)

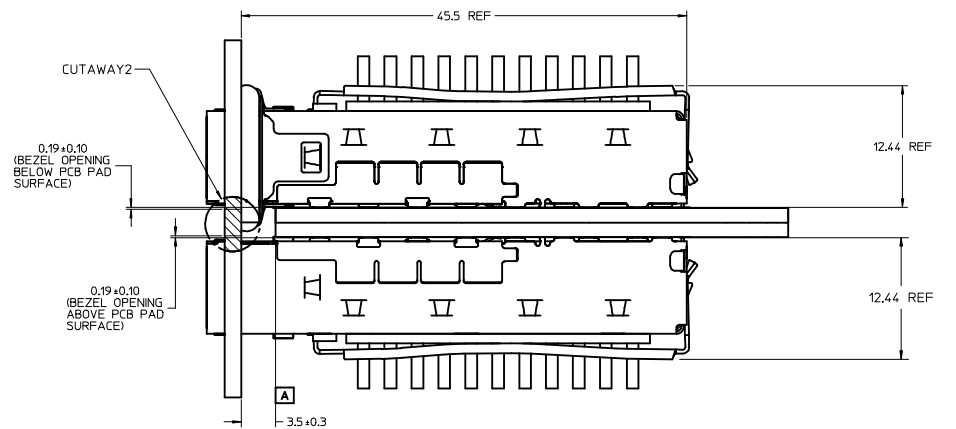
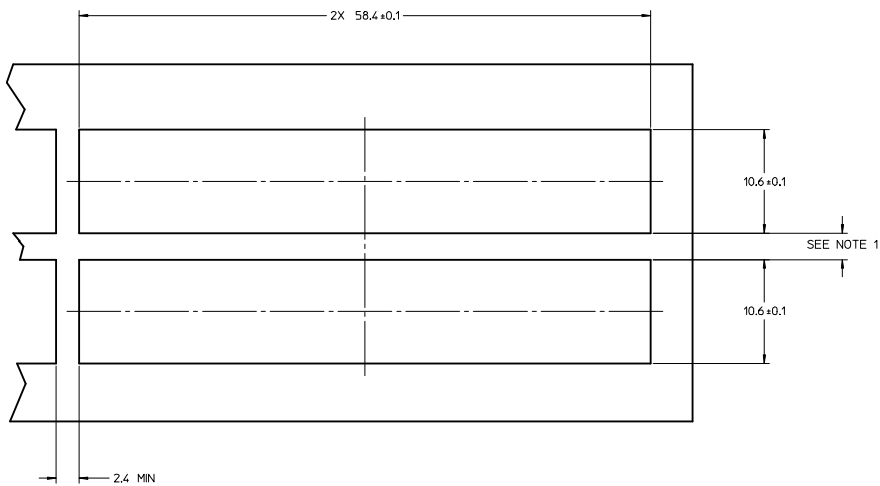

- NOTE:
- PCB THICKNESS VARIATION MUST BE CONSIDERED WHEN DETERMINING BEZEL OPENING LOCATION.
 - CAGE LEG STANDOFF WILL PIERCE BELLY GASKET WHEN PROPERLY PRESSED INTO PCB.

SEE REVISION TABLE EEC NO: CPG2016-2975 DRAWN: CHENG03 CHKD: APPR: CHEN08 DATE: 2016/02/04	QUALITY SYMBOLS	GENERAL TOLERANCES (UNLESS SPECIFIED)	DIMENSION STYLE	SCALE	DESIGN UNITS	THIRD ANGLE PROJECTION
	▽=0	mm INCH	MM ONLY	4:1	METRIC	
	▽=0	4 PLACES ± 0.13				
	▽=0	3 PLACES ± 0.25				
		ANGULAR ± 1°				
		DRAFT WHERE APPLICABLE MUST REMAIN WITHIN DIMENSIONS				
			DRAWN BY: JHATTON	DATE: 2012/12/03	TITLE: SFP+ 1X4 CAGE, 3.05MM PRESS FIT, HEAT SINK, ELASTOMERIC GASKET	
			CHECKED BY: MMCKERVEY	DATE: 2012/12/07	molex DOCUMENT NO: SD-111112-2410 SHEET NO: 8 OF 9	
			APPROVED BY: KLOYD	DATE: 2012/12/20		
			MATERIAL NO. SEE SHEET 3			
			THIS DRAWING CONTAINS INFORMATION THAT IS PROPRIETARY TO MOLEX INCORPORATED AND SHOULD NOT BE USED WITHOUT WRITTEN PERMISSION			

DATE	REV	DESCRIPTION
2012/12/03	A	1. INITIAL RELEASE
2013/01/23	B	1. REMOVED EMI GASKET FROM TOP, ØI16, AND RIGHT SIDE, ØE12, VIEWS FOR CLARITY. ADDED EMI GASKET UNCOMPRESSED OVERALL DIMENSIONS TO FRONT VIEW, ØE16. ADDED 9.98 REF DIM. TO SIDE VIEW. ADDED BACK VIEW W/INNER WALL WELD NOTE, ØE3. REMOVED BELLY ISO VIEW CHANGED ALL VIEWS ON SHEET 1 TO 747540410 CLOSED TOP BASE CAGE. MOVED MIN PCB THICKNESS NOTE TO RESPECTIVE PCB LAYOUT SHEETS. REMOVED INSERTION FORCE FROM NOTE 2. UPDATED PN/DATE CODE PRINTING CALLOUT ON SIDE VIEW. ADDED FIX TEXT OVERALL LENGTH TO DIM. 49.0 REF ØJ14. ADDED APPLICATION NOTE ØM10. ADDED TYP TO DIMENSION 3.05 REF ON SIDE VIEW ØE8 (SHEET 1). 2. ADDED 'REAR LEG OPTIONS' SECTION, ØB16. REMOVED CAGES FROM HEATSINK OPTIONS VIEWS & UPDATED TABLES, ØJ2, J6 & J11. MOVED BELLY VIEW TO, D9. ADDED BELLY VIEW ØD3. ADDED OPEN TOP VIEW Ø17. ADDED OVERALL HEATSINK NOTE TO TABLES Ø12, 16, & 111. ADDED ▽ & ▽ TO ISO BELLY VIEW ØD3. (SHEET 2). 3. ADDED PN'S 747540410, 747540411, 747540415, 747540419 & 1111110410 ADDING VIEWS AND PN TABLES. ADDED # OF REAR LEGS PER PORT COLUMN TO TABLES. (SHEET 3) 4. REMOVED BASIC TOLERANCE FROM DIMENSION 35.4 TYP, ØF8. ADDED MIN PCB THICKNESS NOTE. ADDED DIAMETER DIMENSION Ø0.95 ± 0.05 X4 ØD15. MOVED TYP FROM DIMENSION BOXES. ADDED DATUM A & DATUM B. ADDED NOTES 1 THRU 4. (SHEET 4) 5. REMOVED BASIC TOLERANCE FROM DIMENSION 35.4 TYP, ØF5. ADDED MIN PCB THICKNESS NOTE. REMOVED PAD ØF14. ADDED NOTES 1 THRU 4. (SHEET 5). 6. REMOVED BELLY TO BELLY PCB VIEW, CENTERED SINGLE SIDED VIEW AND ADDED APPLICATION NOTE TO SHEET TITLE. REMOVED DIMENSION 1.7 REF (SHEET 6) 7. CHANGED TOLERANCE ON DIMENSIONS 0.19 TO 0.19 ±0.10, ØD9 & F9. ADDED CENTER LINES TO BEZELS. REMOVED 'CUTAWAY'S FROM SIDE VIEWS. REMOVED 'SEE NOTE 1' FROM 10.6 ±0.1 BEZEL OPENING SIZE DIMENSIONS ØD10 & E10. REMOVED 'SIZE, AND' FROM NOTE 1. ADDED 'SEE NOTE 1' TO BELLY TO BELLY BEZEL OPENING PITCH. (SHEET 7) 8. MOVED NOTES TO BOTTOM LEFT CORNER AND INCREASED TEXT HEIGHT, (SHEETS 1, 4, 5 & 7). CHANGED DRAWING DIMENSION STYLE TO MM ONLY. CHANGED THE GENERAL ANGLE TOLERANCE TO 1° FOR ALL SHEETS.
2014/02/05	C	1. MOVED DATE CODE FROM VIEW ØE9 TO VIEW ØE5. REVISED NOTE 4 'WAS' WELD SPOT WILL SHOW SLIGHT MATERIAL DISCOLORATION. 'NOW READS' WELD SPOT MAY SHOW SLIGHT MATERIAL DISCOLORATION SHEET 1. 2. MOVED VIEW ØE4 SHEET 2 TO THE REVISED SHEET 3 ØK4. ADDED VIEW AND DATE CODE ØE5. 3. ADDED NEW SHEET 3: PREVIOUS SHEET 3-8 INCREASED BY ONE NUMBER. ADDED NOTE 1 ØA20. REMOVED NOTE FROM ISO VIEW Ø16. 4. ADDED VIEW ØF8 AND REVISED PART NUMBER 'WAS' 747540410. 'NOW READS' 1111110410 ØG12 SHEET 4.
2014/05/12	D	1. ADDED P/N 74754-0470 [SHEET 4]
2014/09/09	E	1. ADDED P/N 100114-4410. [SHEET 4]
2015/07/16	F	1. REVISED COLUMN LABEL UL RATING TO FLAMMABILTY RATING IN TABLE ØD7. 2. REVISED PART NO. 100114-4410 NOTES ØD7 'WAS' UL TESTING PENDING. 'NOW' UL94 V-0. SHEET 4 3. ADDED NOTE 2 ØA20. SHEET 8
2015/10/26	G	SHEET 1: A19: ADDED NOTE *7. MOST OF P/N ARE WITH 14.05 REF EXCEPT 747540415 & 747540419 ARE 12.55 REF*. E12: CHANGED '14.05 REF (ACROSS FRAME)' TO 'SEE NOTE 7. (ACROSS FRAME)'.
2016/02/03	H	1. SHEET 3 & 4: REMOVE 1111110410.

SEE REVISION TABLE EEC NO: CPG2016-2975 DRAWN BY: DRWACHENG03 CHKD: APPR:RCHENG08 DATE: 2016/02/04	QUALITY SYMBOLS	GENERAL TOLERANCES (UNLESS SPECIFIED)	DIMENSION STYLE	SCALE	DESIGN UNITS	THIRD ANGLE PROJECTION
	▽=0	4 PLACES ±--- ±---	MM ONLY	1:1	METRIC	TITLE: SFP+ 1X4 CAGE, 3.05MM PRESS FIT, HEAT SINK, ELASTOMERIC GASKET molex MATERIAL NO. SD-111112-2410 DOCUMENT NO. SD-111112-2410 SHEET NO. 9 OF 9
	▽=0	3 PLACES ±--- ±---	mm			
	▽=0	2 PLACES ±0.13 ±---	INCH			
▽=0	1 PLACE ±0.25 ±---					
		0 PLACE ±--- ±---				
		ANGULAR ± 1 °				
		DRAFT WHERE APPLICABLE MUST REMAIN WITHIN DIMENSIONS	SEE SHEET 3			
			THIS DRAWING CONTAINS INFORMATION THAT IS PROPRIETARY TO MOLEX INCORPORATED AND SHOULD NOT BE USED WITHOUT WRITTEN PERMISSION			