

# GTRA184602FC

Thermally-Enhanced High Power RF GaN on SiC HEMT  
460 W, 48 V, 1805 – 1880 MHz

## Description

The GTRA184602FC is a 460-watt ( $P_{3dB}$ ) GaN on SiC high electron mobility transistor (HEMT) for use in multi-standard cellular power amplifier applications. It features input matching, high efficiency, and a thermally-enhanced package with earless flange.

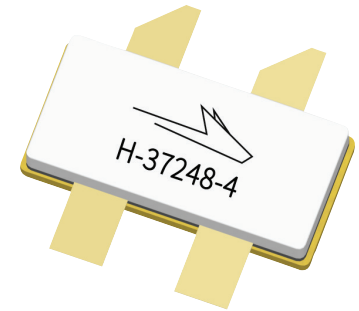

Package Types: H-37248C-4

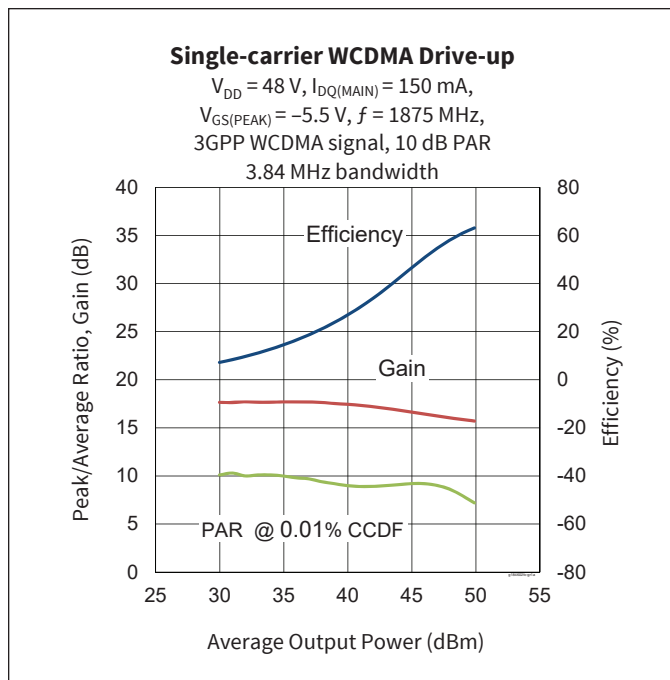

## Features

- GaN on SiC HEMT technology
- Input matched
- Asymmetric Doherty design
  - Main:  $P_{3dB} = 160\text{ W Typ}$
  - Peak:  $P_{3dB} = 300\text{ W Typ}$
- Typical pulsed CW performance: 48 V, 1845 MHz, 16 $\mu$ sec pulse width, 10% duty cycle (Doherty configuration)
  - Output Power: 460 W @  $P_{3dB}$
  - Efficiency: 62% @  $P_{OUT} = 49\text{ dBm}$
  - Gain: 16 dB @  $P_{OUT} = 49\text{ dBm}$
- Capable of handling 10:1 VSWR @48 V, 80 W (CW) output power
- Human Body Model Class 1A (per ANSI/ESDA/JEDEC JS-001)
- Low thermal resistance
- Pb-free and RoHS compliant

## RF Characteristics

### Single-carrier WCDMA Specifications (tested in WolfSpeed Doherty test fixture)

$V_{DD} = 48\text{ V}$ ,  $I_{DQ} = 150\text{ mA}$ ,  $P_{OUT} = 80\text{ W avg}$ ,  $V_{GS(PEAK)} = -5.5\text{ V}$ ,  $f = 1880\text{ MHz}$ , 3GPP signal, channel bandwidth = 3.84 MHz, peak/average = 10 dB @ 0.01% CCDF

Characteristic	Symbol	Min.	Typ.	Max.	Unit
Gain	$G_{ps}$	14	15.5	—	dB
Drain Efficiency	$\eta_D$	54.5	60	—	%
Adjacent Channel Power Ratio	ACPR	—	-27.5	-24.5	dBc
Output PAR @ 0.01% CCDF	OPAR	7.1	7.8	—	dB

Note:

All published data at  $T_{CASE} = 25^\circ\text{C}$  unless otherwise indicated  
 ESD: Electrostatic discharge sensitive device—observe handling precautions!





## RF Characteristics, 1805 MHz

**Single-carrier WCDMA Specifications** (not subject to production test. Verified by design/characterization in production test circuit)  
 $V_{DD} = 48\text{ V}$ ,  $I_{DQ} = 150\text{ mA}$ ,  $P_{OUT} = 80\text{ W avg}$ ,  $V_{GS(PEAK)} = -5.5\text{ V}$ ,  $f = 1805\text{ MHz}$ , 3GPP signal, channel bandwidth = 3.84 MHz,  
 peak/average = 10 dB @ 0.01% CCDF

Characteristic	Symbol	Min.	Max.	Unit
Gain	$G_{ps}$	14.5	—	dB
Drain Efficiency	$\eta_D$	52	—	%
Adjacent Channel Power Ratio	ACPR	—	-23.5	dBc
Output PAR @ 0.01% CCDF	OPAR	6.5	—	dB

## DC Characteristics

Characteristic	Symbol	Min.	Typ.	Max.	Unit	Conditions
Drain-source Breakdown Voltage (main)	$V_{BR(DSS)}$	150	—	—	V	$V_{GS} = -8\text{ V}$ , $I_D = 10\text{ mA}$
Drain-source Breakdown Voltage (peak)						
Drain-source Leakage Current	$I_{DSS}$	—	—	5.5	mA	$V_{GS} = -8\text{ V}$ , $V_{DS} = 10\text{ V}$
Gate Threshold Voltage (main)	$V_{GS(th)}$	-3.8	-3.0	-2.3	V	$V_{DS} = -10\text{ V}$ , $I_D = 20\text{ mA}$
Gate Threshold Voltage (peak)						$V_{DS} = -10\text{ V}$ , $I_D = 38\text{ mA}$

## Recommended Operating Conditions

Parameter	Symbol	Min.	Typ.	Max.	Unit	Conditions
Drain Operating Voltage	$V_{DD}$	0	—	50	V	$V_{DS} = 48\text{ V}$ , $I_D = 150\text{ mA}$
Gate Quiescent Voltage	$V_{GS(Q)}$	-3.9	-3.0	-2.1		

## Absolute Maximum Ratings

Parameter	Symbol	Value	Unit
Drain-source Voltage	$V_{DSS}$	125	V
Gate-Source Voltage	$V_{GS}$	-10 to +2	
Operating Voltage	$V_{DD}$	55	
Gate Current (main)	$I_G$	20	mA
Gate Current (peak)		38	
Drain Current (main)	$I_D$	7.5	A
Drain Current (peak)		14.4	
Junction Temperature	$T_J$	225	°C
Storage Temperature Range	$T_{STG}$	-65 to +150	

Operation above the maximum values listed here may cause permanent damage. Maximum ratings are absolute ratings; exceeding only one of these values may cause irreversible damage to the component. Exposure to absolute maximum rating conditions for extended periods may affect device reliability. For reliable continuous operation, the device should be operated within the operating voltage range ( $V_{DD}$ ) specified above.



## Thermal Characteristics

Thermal resistance, junction to case ( $T_{CASE} = 70^{\circ}\text{C}$ ,  $f = 1842.5\text{ MHz}$ )

Characteristic	Symbol	Value	Unit	Conditions
Thermal Resistance (main)	$R_{\theta JC}$	2.0	$^{\circ}\text{C}/\text{W}$	$P_{DISS} = 40\text{ W DC}$ , $48\text{ V}$ , $I_{DQ} = 150\text{ mA}$
Thermal Resistance (peak)		1.2		$P_{DISS} = 77\text{ W DC}$ , $48\text{ V}$ , $V_{GSPK} = -5.5\text{ VmA}$

## Ordering Information

Type and Version	Order Code	Package	Shipping
GTRA184602FC V1 R0	GTRA184602FC-V1-R0	H-37248C-4, earless flange	Tape & Reel, 50 pcs
GTRA184602FC V1 R2	GTRA184602FC-V1-R2	H-37248C-4, earless flange	Tape & Reel, 250 pcs



**Typical Performance** (data taken in a Wolfspeed production test fixture)

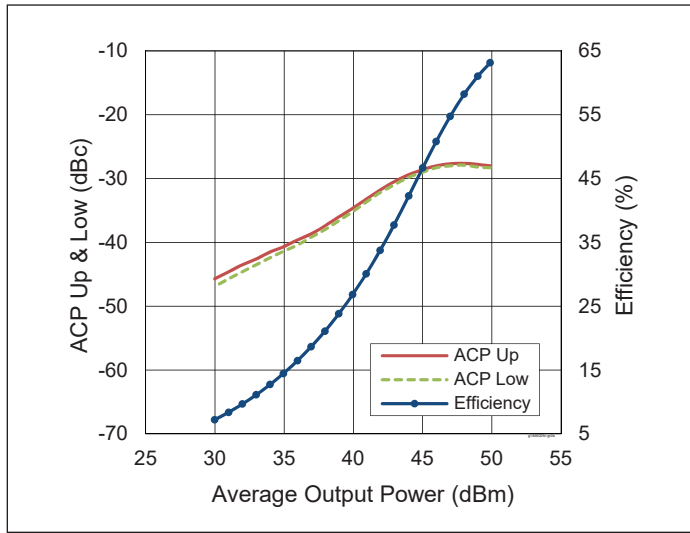

**Figure 1.** Single-carrier WCDMA Drive-up

$V_{DD} = 48\text{ V}$ ,  $I_{DQ(MAIN)} = 150\text{ mA}$ ,  
 $V_{GS(PEAK)} = -5.5\text{ V}$ ,  $f = 1875\text{ MHz}$ ,  
 3GPP WCDMA signal, 10 dB PAR,  
 3.84 MHz bandwidth

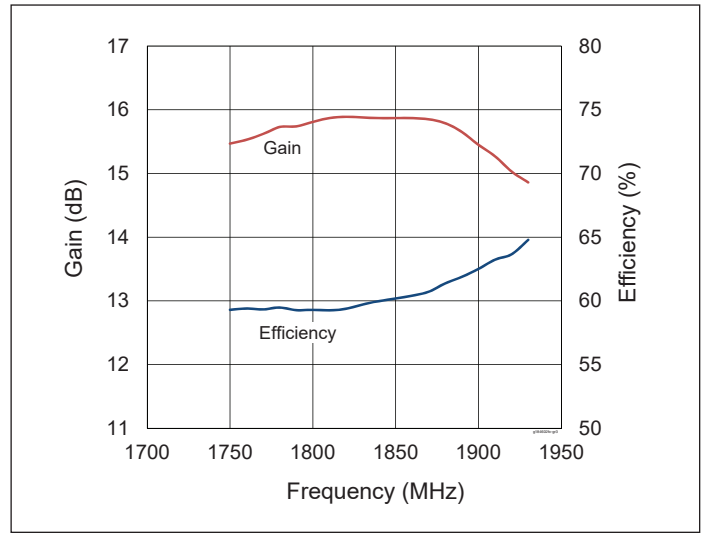

**Figure 2.** Single-carrier WCDMA Broadband Performance

$V_{DD} = 48\text{ V}$ ,  $I_{DQ(MAIN)} = 150\text{ mA}$ ,  
 $V_{GS(PEAK)} = -5.5\text{ V}$ ,  $P_{OUT} = 49.03\text{ dBm}$ ,  
 3GPP WCDMA signal, PAR = 10 dB

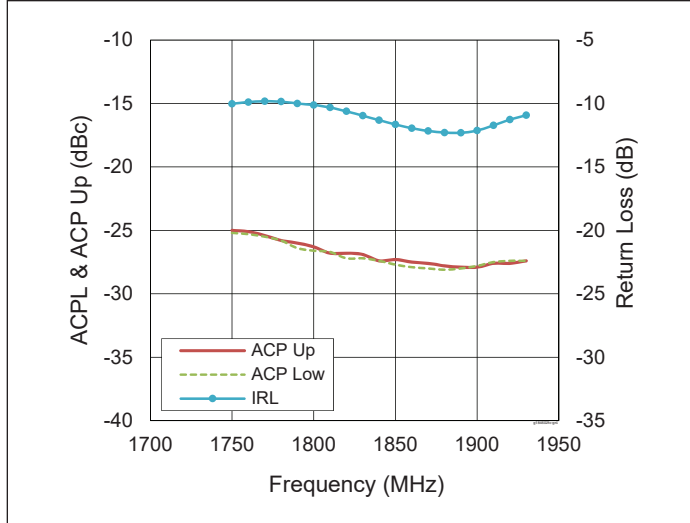

**Figure 3.** Single-carrier WCDMA Broadband Performance

$V_{DD} = 48\text{ V}$ ,  $I_{DQ(MAIN)} = 150\text{ mA}$ ,  
 $V_{GS(PEAK)} = -5.5\text{ V}$ ,  $P_{OUT} = 49.03\text{ dBm}$ ,  
 3GPP WCDMA signal, PAR = 10 dB

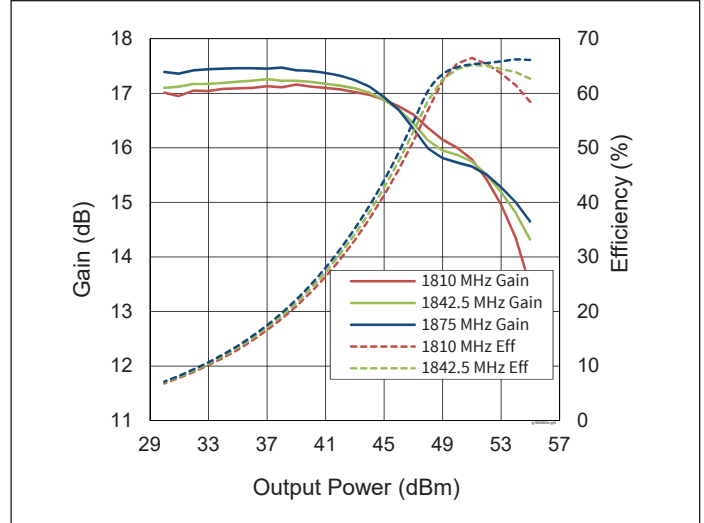
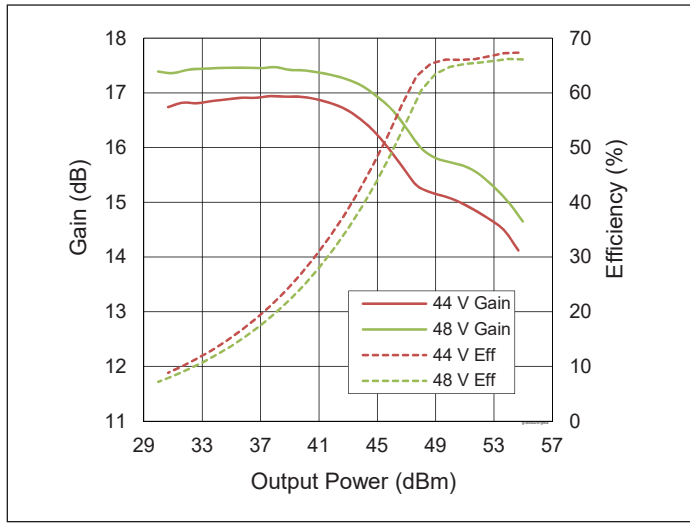

**Figure 4.** CW Performance

$V_{DD} = 48\text{ V}$ ,  $I_{DQ(MAIN)} = 150\text{ mA}$ ,  
 $V_{GS(PEAK)} = -5.5\text{ V}$



**Typical Performance** (cont.)



**Figure 5.** CW Performance at various  $V_{DD}$

$I_{DQ(MAIN)} = 150 \text{ mA}$ ,  $V_{GS(PEAK)} = -5.8 \text{ V}$ ,  
 $f = 1875 \text{ MHz}$

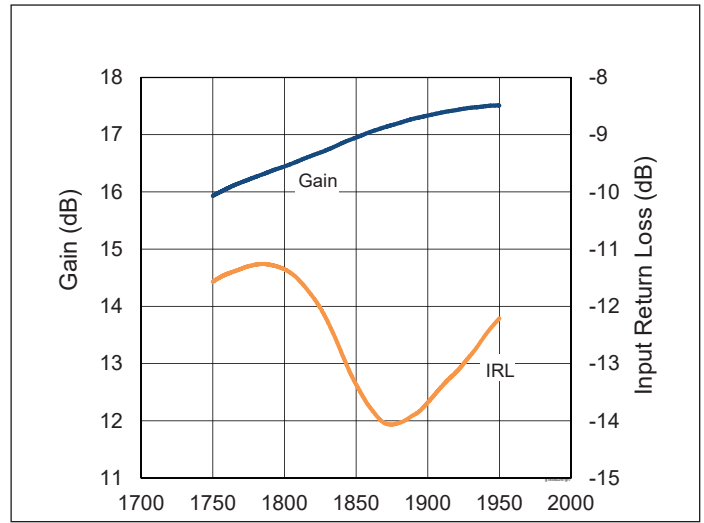

**Figure 6.** CW Performance Small Signal Gain & Input Return Loss

$V_{DD} = 48 \text{ V}$ ,  $I_{DQ(MAIN)} = 150 \text{ mA}$ ,  
 $V_{GSPEAK} = -5.5 \text{ V}$

**Load Pull**

**Main Side Load Pull Performance** – Pulsed CW signal: 16  $\mu\text{s}$ , 10% duty cycle, 48 V,  $I_{DQ} = 150 \text{ mA}$

Class AB		$P_{3dB}$									
		Max Output Power					Max Drain Efficiency				
Freq [MHz]	Zs [ $\Omega$ ]	Zl [ $\Omega$ ]	Gain [dB]	$P_{OUT}$ [dBm]	$P_{OUT}$ [W]	$\eta_D$ [%]	Zl [ $\Omega$ ]	Gain [dB]	$P_{OUT}$ [dBm]	$P_{OUT}$ [W]	$\eta_D$ [%]
1805	7.6 – j7.2	3 – j5.1	16.4	53.35	216	65	3.1 – j2.4	18.8	52.30	170	80
1880	7.4 – j7.6	3 – j5.1	17.3	53.40	219	71	2.9 – j2.8	19.2	51.80	151	80

**Peak Side Load Pull Performance** – Pulsed CW signal: 16  $\mu\text{s}$ , 10% duty cycle, 48 V,  $V_{GS(PEAK)} = -3.3 \text{ V}$

Class C		$P_{3dB}$									
		Max Output Power					Max Drain Efficiency				
Freq [MHz]	Zs [ $\Omega$ ]	Zl [ $\Omega$ ]	Gain [dB]	$P_{OUT}$ [dBm]	$P_{OUT}$ [W]	$\eta_D$ [%]	Zl [ $\Omega$ ]	Gain [dB]	$P_{OUT}$ [dBm]	$P_{OUT}$ [W]	$\eta_D$ [%]
1805	4.54 – j6.07	2.21 – j4.67	15.8	56.70	468	66	2.23 – j2.6	17.6	55.30	339	78
1880	4.53 – j6.07	2.22 – j5.37	15.9	56.80	479	65	1.58 – j2.27	17.4	53.60	229	81



## Evaluation Board

Test Fixture Part Number	LTA/GTRA184602FC-V1
PCB Information	Rogers 4350, 0.762mm [0.030"] thick, 2 oz. copper, $\epsilon_r = 3.66$

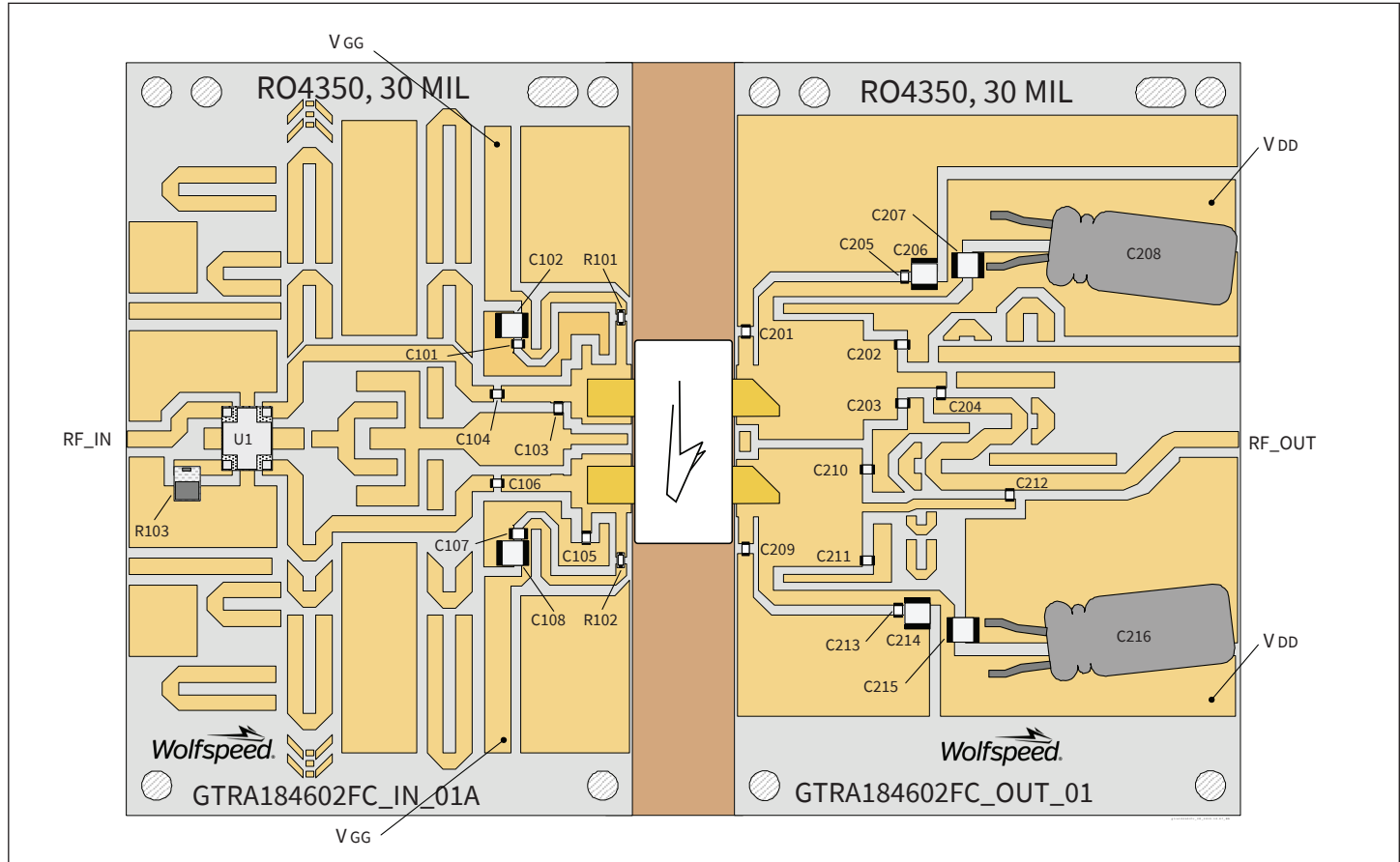

Reference circuit assembly diagram (not to scale)

## Components Information

Component	Description	Manufacturer	P/N
In			
C101, C104, C106, C107	Capacitor, 18 pF	ATC	ATC600S180JT250XT
C102, C108	Capacitor, 10 $\mu$ F, 100 V	Murata Electronics	GRM32EC72A106KE05L
C103, C105	Capacitor, 2.7 pF	ATC	ATC600S2R7CT250XT
R101, R102	Resistor, 10 ohms	Panasonic – ECG	ERJ-3GEYJ100V
R103	Resistor, 50 ohms	Anaren	C8A50Z4A
U1	Hybrid Coupler	Anaren	X3C19P1-03S



## Components Information (cont.)

Out			
C201	Capacitor, 1.5 pF	ATC	ATC600S1R5CT250XT
C202, C210	Capacitor, 0.5 pF	ATC	ATC600S0R5CT250XT
C203	Capacitor, 1.0 pF	ATC	ATC600S1R0CT250XT
C204	Capacitor, 6.8 pF	ATC	ATC800A6R8CT250XT
C205, C213	Capacitor, 18 pF	ATC	ATC600S180JT250XT
C206, C207, C214, C215	Capacitor, 10 $\mu$ F, 100 V	Murata Electronics	GRM32EC72A106KE05L
C208, C216	Capacitor, 470 $\mu$ F, 100 V	Panasonic – ECG	ECA-2AHG471B
C209	Capacitor, 1.3 pF	ATC	ATC6001R3CT250XT
C211	Capacitor, 1.2 pF	ATC	ATC6001R2CT250XT
C212	Capacitor, 2.7 pF	ATC	ATC6002R7CT250XT

## Bias Sequencing

### Bias ON

1. Ensure RF is turned off
2. Apply pinch-off voltage of  $-5$  V to the gate
3. Apply nominal drain voltage
4. Bias gate to desired quiescent drain current
5. Apply RF

### Bias OFF

1. Turn RF off
2. Apply pinch-off voltage to the gate
3. Turn-off drain voltage
4. Turn-off gate voltage

## Pinout Diagram (top view)

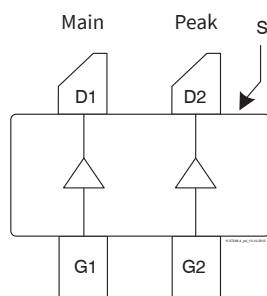

Pin	Description
D1	Drain device 1
D2	Drain device 2
G1	Gate device 1
G2	Gate device 2
S	Source (flange)



Package Outline Specifications – Package H-37248C-4

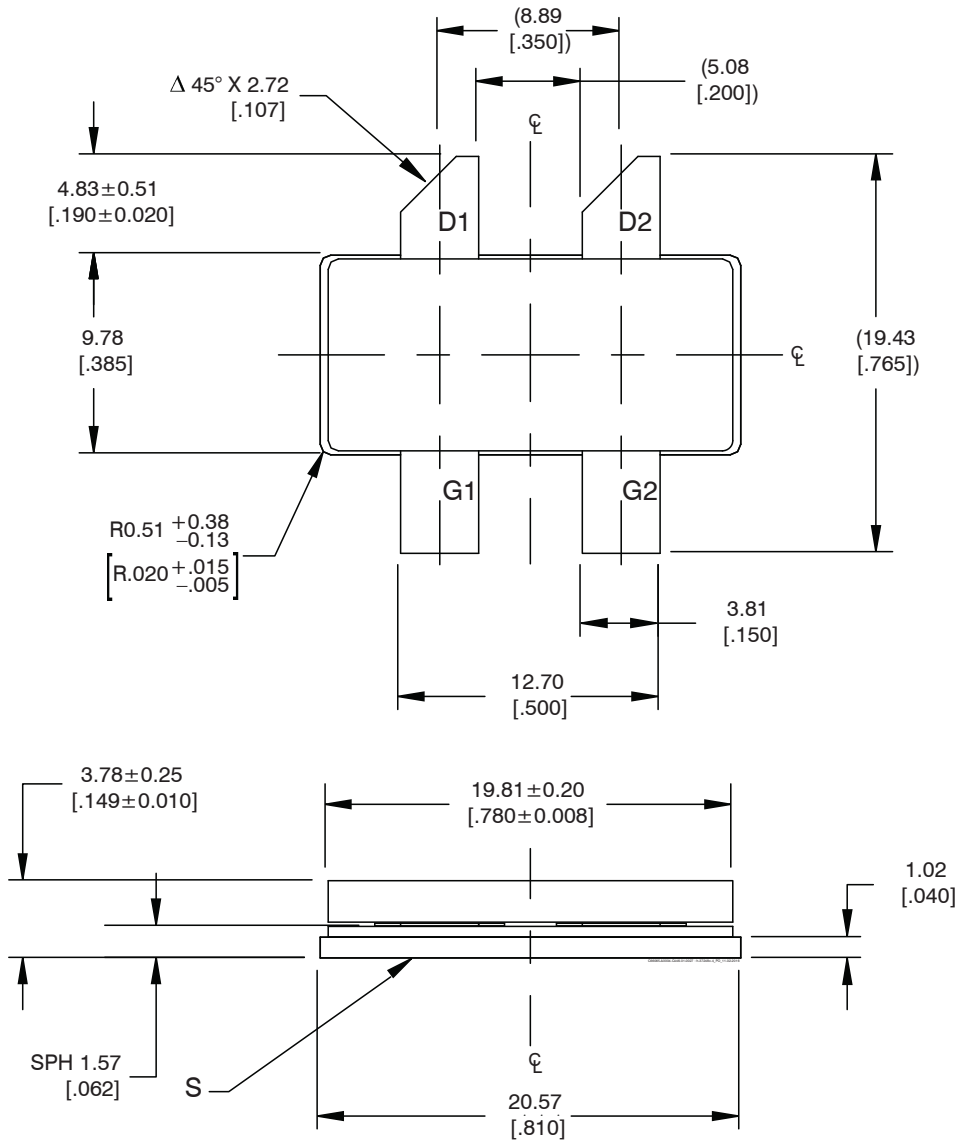

Diagram Notes—unless otherwise specified:

1. Interpret dimensions and tolerances per ASME Y14.5M-1994
2. Primary dimensions are mm, alternate dimensions are inches
3. All tolerances  $\pm 0.127$  [ $0.005$ ]
4. Pins: D1, D2 – drain, G1, G2 – gate, S – source (flange)
5. Lead thickness:  $0.13 \pm 0.05$  [ $0.005 \pm 0.002$ ]
6. Gold plating thickness:  $1.14 \pm 0.38$  micron [ $45 \pm 15$  microinch]



**For more information, please contact:**

4600 Silicon Drive  
Durham, NC 27703 USA  
Tel: +1.919.313.5300  
[www.wolfspeed.com/RF](http://www.wolfspeed.com/RF)

Sales Contact  
[RFSales@wolfspeed.com](mailto:RFSales@wolfspeed.com)

RF Product Marketing Contact  
[RFMarketing@wolfspeed.com](mailto:RFMarketing@wolfspeed.com)

## Notes & Disclaimer

---

Specifications are subject to change without notice. “Typical” parameters are the average values expected by Wolfspeed in large quantities and are provided for information purposes only. Wolfspeed products are not warranted or authorized for use as critical components in medical, life-saving, or life-sustaining applications, or other applications where a failure would reasonably be expected to cause severe personal injury or death. No responsibility is assumed by Wolfspeed for any infringement of patents or other rights of third parties which may result from use of the information contained herein. No license is granted by implication or otherwise under any patent or patent rights of Wolfspeed.

© 2023 Wolfspeed, Inc. All rights reserved. Wolfspeed® and the Wolfstreak logo are registered trademarks and the Wolfspeed logo is a trademark of Wolfspeed, Inc.  
PATENT: <https://www.wolfspeed.com/legal/patents>

*The information in this document is subject to change without notice.*