

## PCB terminal block - SPTAF 1/ 3-3,5-IL - 1861946

Please be informed that the data shown in this PDF Document is generated from our Online Catalog. Please find the complete data in the user's documentation. Our General Terms of Use for Downloads are valid (<http://phoenixcontact.com/download>)

PCB terminal block, nominal current: 16 A, pitch: 3.5 mm, number of positions: 3, connection method: Push-in spring connection, mounting: Wave soldering, conductor/PCB connection direction: 45 °, color: green



The figure shows a 10-position version of the product

### Your advantages

- ✓ Time saving push-in connection, tools not required
- ✓ Defined contact force ensures that contact remains stable over the long term
- ✓ Intuitive use through colour coded actuation lever
- ✓ Small component size for applications where space is at a premium
- ✓ Quick and convenient testing using integrated test option

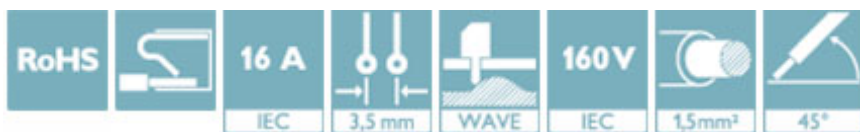

### Key Commercial Data

Packing unit	150 pc
Minimum order quantity	150 pc
GTIN	 4 055626 134086
GTIN	4055626134086

### Technical data

#### Dimensions

Length [ l ]	11 mm
Pitch	3.5 mm
Dimension a	7 mm
Width [ w ]	12 mm
Height	8 mm
Height [ h ]	10.6 mm
Solder pin [P]	2.6 mm
Pin spacing	5 mm
Hole diameter	1.1 mm

# PCB terminal block - SPTAF 1/ 3-3,5-IL - 1861946

## Technical data

### General

Range of articles	SPTAF 1/...IL
Insulating material group	I
Rated surge voltage (III/3)	2.5 kV
Rated surge voltage (III/2)	2.5 kV
Rated surge voltage (II/2)	2.5 kV
Rated voltage (III/3)	160 V
Rated voltage (III/2)	160 V
Rated voltage (II/2)	320 V
Connection in acc. with standard	EN-VDE
Nominal current $I_N$	16 A
Nominal cross section	1.5 mm <sup>2</sup>
Maximum load current	16 A
Insulating material	PA
Contact material	Sn
Flammability rating according to UL 94	V0
Stripping length	8 mm
Number of positions	3

### Connection data

Conductor cross section solid min.	0.2 mm <sup>2</sup>
Conductor cross section solid max.	1.5 mm <sup>2</sup>
Conductor cross section flexible min.	0.2 mm <sup>2</sup>
Conductor cross section flexible max.	1.5 mm <sup>2</sup>
Conductor cross section flexible, with ferrule without plastic sleeve min.	0.25 mm <sup>2</sup>
Conductor cross section flexible, with ferrule without plastic sleeve max.	0.75 mm <sup>2</sup>
Conductor cross section flexible, with ferrule with plastic sleeve min.	0.25 mm <sup>2</sup>
Conductor cross section flexible, with ferrule with plastic sleeve max.	0.75 mm <sup>2</sup>
Conductor cross section AWG min.	24
Conductor cross section AWG max.	16

### Standards and Regulations

Connection in acc. with standard	EN-VDE
Flammability rating according to UL 94	V0

### Environmental Product Compliance

China RoHS	Environmentally friendly use period: unlimited = EFUP-e
	No hazardous substances above threshold values

## Drawings

# PCB terminal block - SPTAF 1/ 3-3,5-IL - 1861946

Drilling diagram

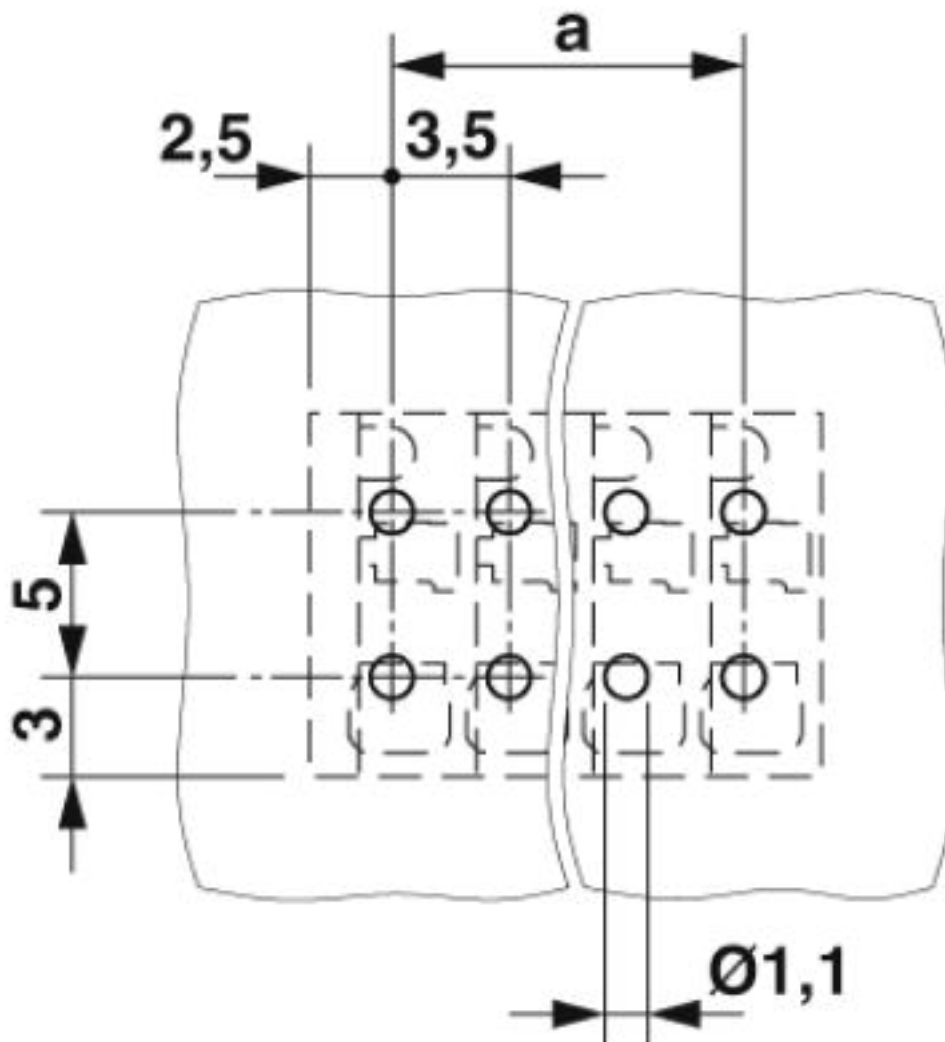

# PCB terminal block - SPTAF 1/ 3-3,5-IL - 1861946

Diagram

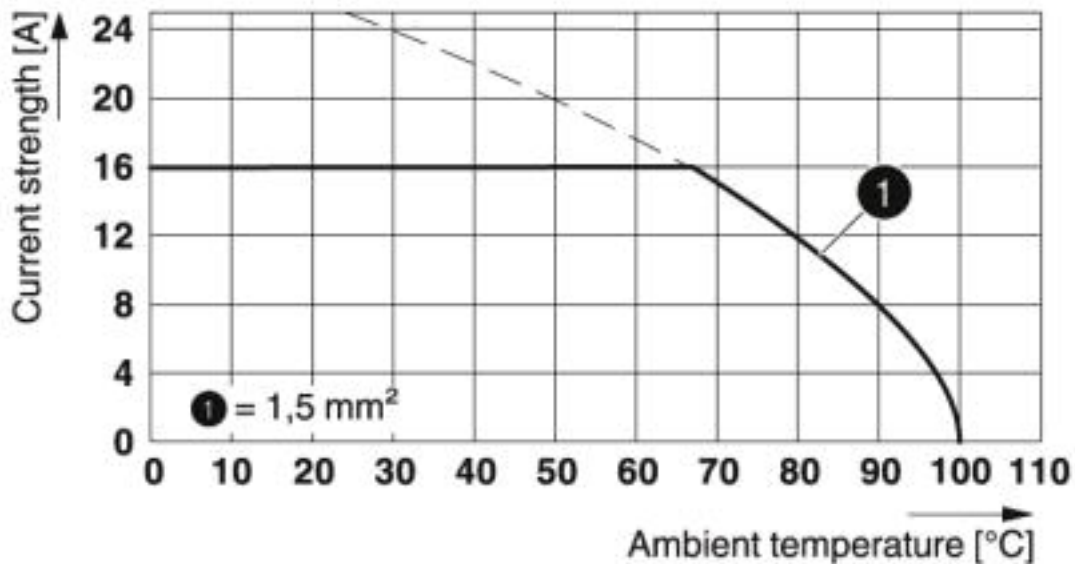

Type: SPTAF 1/...-3,5-IL(EL)

Dimensional drawing

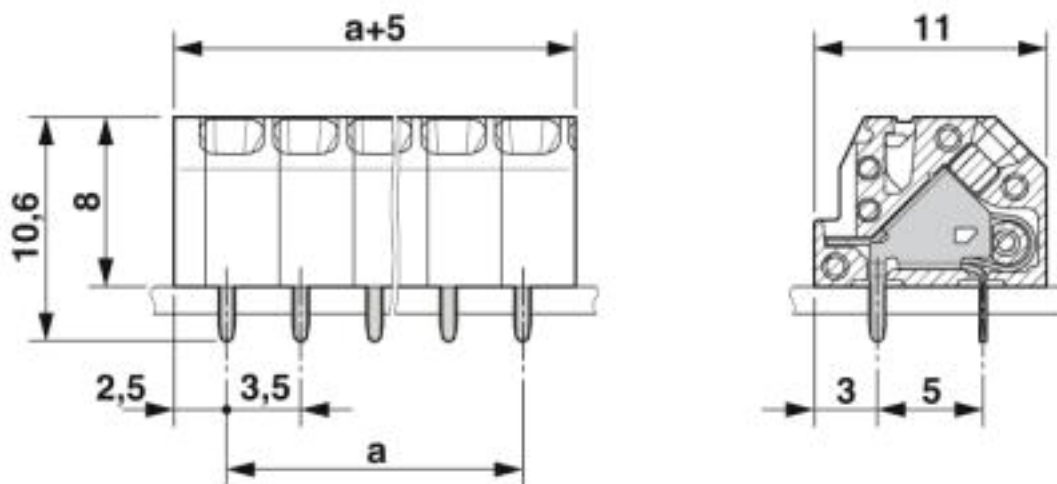

Approvals

Approvals

Approvals

IECEE CB Scheme / VDE Zeichengenehmigung / cULus Recognized

Ex Approvals

# PCB terminal block - SPTAF 1/ 3-3,5-IL - 1861946

## Approvals

### Approval details

IECEE CB Scheme		<a href="http://www.iecee.org/">http://www.iecee.org/</a>	DE1-61914
Nominal voltage UN	160 V		
Nominal current IN	16 A		
mm <sup>2</sup> /AWG/kcmil	0.2-1.5		

VDE Zeichengenehmigung		<a href="http://www2.vde.com/de/Institut/Online-Service/VDE-gepruefteProdukte/Seiten/Online-Suche.aspx">http://www2.vde.com/de/Institut/Online-Service/VDE-gepruefteProdukte/Seiten/Online-Suche.aspx</a>	40047107
Nominal voltage UN	160 V		
Nominal current IN	16 A		
mm <sup>2</sup> /AWG/kcmil	0.2-1.5		

cULus Recognized		<a href="http://database.ul.com/cgi-bin/XYV/template/LISEXT/1FRAME/index.htm">http://database.ul.com/cgi-bin/XYV/template/LISEXT/1FRAME/index.htm</a>	E60425-20061129
	B	D	
Nominal voltage UN	300 V	300 V	
Nominal current IN	8 A	8 A	
mm <sup>2</sup> /AWG/kcmil	24-16	24-16	

Phoenix Contact 2019 © - all rights reserved  
<http://www.phoenixcontact.com>

**PHOENIX CONTACT GmbH & Co. KG**  
 Flachsmarktstr. 8  
 32825 Blomberg  
 Germany  
 Tel. +49 5235 300  
 Fax +49 5235 3 41200  
<http://www.phoenixcontact.com>