

## ALC70C102DD250

Aliases (A546EF102M250C)

ALC70, Aluminum Electrolytic, 1,000 uF, 20%, 250 VDC, -40/+85°C

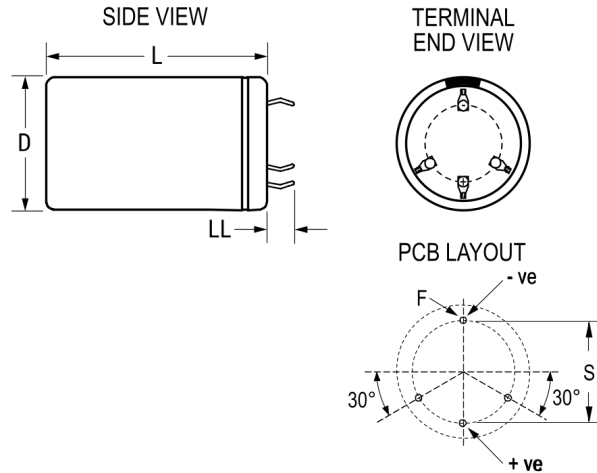

Click [here](#) for the 3D model.

### Dimensions

D	35mm +1mm
L	40mm +/-2mm
S	22.5mm +/-0.1mm
LL	6.3mm +/-1mm
F	2mm +/-0.1mm

### Packaging Specifications

Sleeving	Yes
Packaging	Bulk, Bag

### General Information

Series	ALC70
Dielectric	Aluminum Electrolytic
Description	Snap-In, Aluminum Electrolytic
RoHS	Yes
Lead	4 Pin
AEC-Q200	No
Halogen Free	Yes
Component Weight	65 g
Notes	Dimensions D And L Include Sleeving.
Shelf Life	156 Weeks

### Specifications

Capacitance	1,000 uF
Capacitance Tolerance	20%
Voltage DC	250 VDC, 288 VDC (Surge)
Temperature Range	-40/+85°C
Rated Temperature	85°C
Life	15000 Hrs (Rated Voltage And Ripple Current At 85C), 24000 Hrs (Rated Voltage at 85C)
Resistance	187.7 mOhms (100Hz 20C), 110.6 mOhms (10kHz 20C)
Ripple Current	3.09 Amps (100Hz 85C), 6.117 Amps (10kHz 85C)
Leakage Current	1500 uA (5min 20°C)