

# HCV1206

## High current power inductors

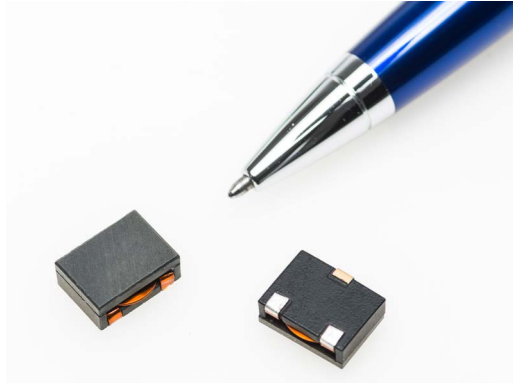

### Product features

- Flat-wire construction
- Low DCR, high efficiency
- Secure 3 terminal mounting
- 12.7 mm x 10.15 mm footprint surface mount package in a 5.1 mm height
- Ferrite core material

### Applications

- Compatible with Picor® Cool-Power® ZVS Buck and Buck-Boost Regulator Families (Picor part number series PI37xx and PI35xx)

### Environmental data

- Storage temperature range (component): -55 °C to +125 °C
- Operating temperature range: -55 °C to +125 °C (ambient plus self-temperature rise)
- Solder reflow temperature: J-STD-020 (latest revision) compliant



Picor® and Cool-Power® are trademarks of Vicor Corporation.

**Product Specifications**

Part Number <sup>4</sup>	OCL <sup>1</sup> ( $\mu$ H) $\pm 10\%$	$I_{rms}^2$ (A)	$I_{sat}^3$ (A)	DCR (m $\Omega$ ) @ +20 °C $\pm 10\%$
HCV1206-R42-R	0.42	16	42	3.15
HCV1206-R48-R	0.48	16	37	3.15
HCV1206-R90-R	0.90	14	28	4.6
HCV1206-1R0-R	1.0	14	24.5	4.6
HCV1206-1R5-R	1.5	12	21	6.0
HCV1206-2R0-R	2.0	12	16	6.0
HCV1206-3R0-R	3.0	11	13	7.4

1. Open Circuit Inductance (OCL) Test Parameters: 100 kHz, 0.1 Vrms, 0.0 Adc, +25 °C

2.  $I_{rms}$ : DC current for an approximate temperature rise of 40 °C without core loss. Derating is necessary for AC currents. PCB layout, trace thickness and width, air-flow, and proximity of other heat generating components will affect the temperature rise. It is recommended that the temperature of the part not exceed +125 °C under worst case operating conditions verified in the end application.

3.  $I_{sat}$ : Peak current for approximately 5% rolloff @ +25 °C

4. Part Number Definition: HCV1206-xxx-R  
HCV1206 = Product code and size  
xxx=Inductance value in  $\mu$ H,  
-R suffix = RoHS compliant

**Dimensions- mm**

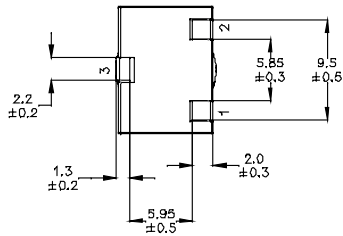
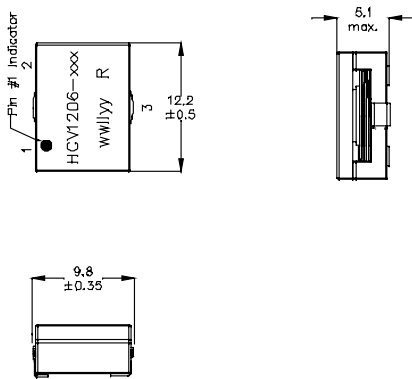

**Recommended Pad Layout**

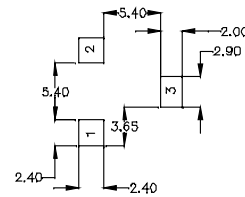

**Schematic**

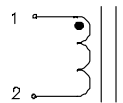

Part marking: HCV1206-xxx, xxx=inductance value in  $\mu$ H, R=decimal point, wwlllyy= date code, R=revision level  
Soldering surfaces to be coplanar within 0.1 millimeters  
Pin 3 is for mounting stability. No connection.  
Do not route traces or vias underneath the inductor.

**Packaging information- mm**

Supplied in tape and reel packaging, 550 parts per 13" diameter reel

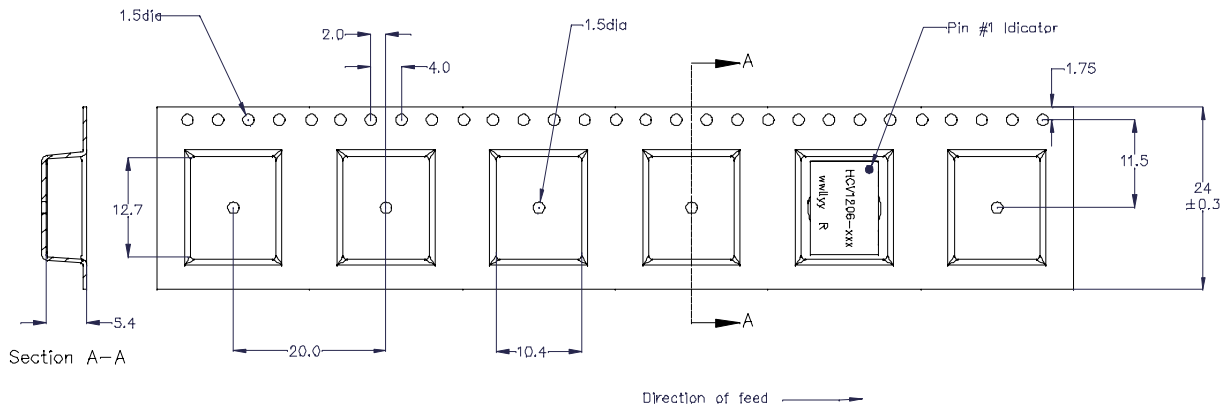

Inductance characteristics

HCV1206-R42-R

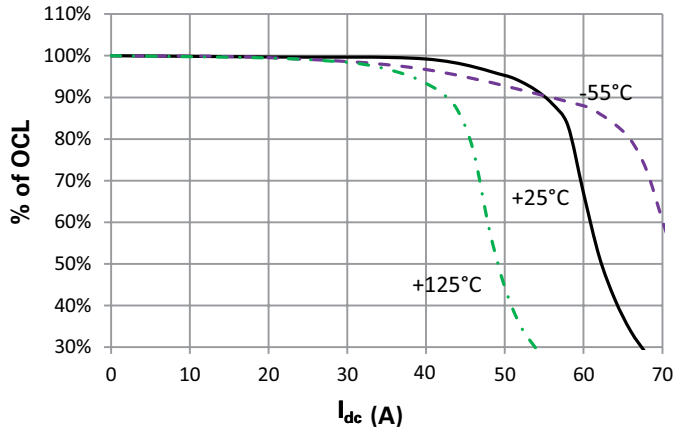

HCV1206-R48-R

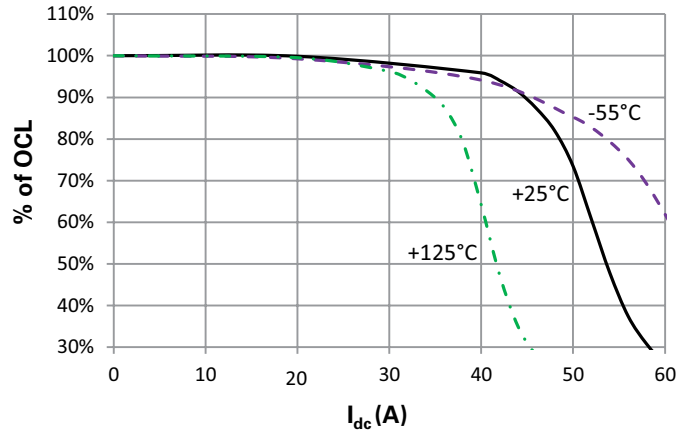

HCV1206-R90-R

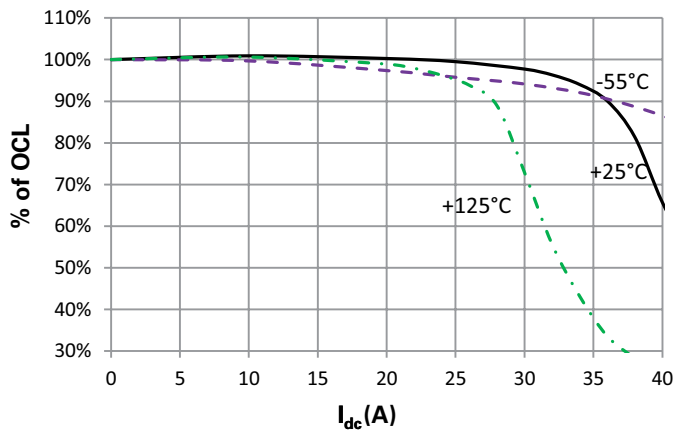

HCV1206-1R0-R

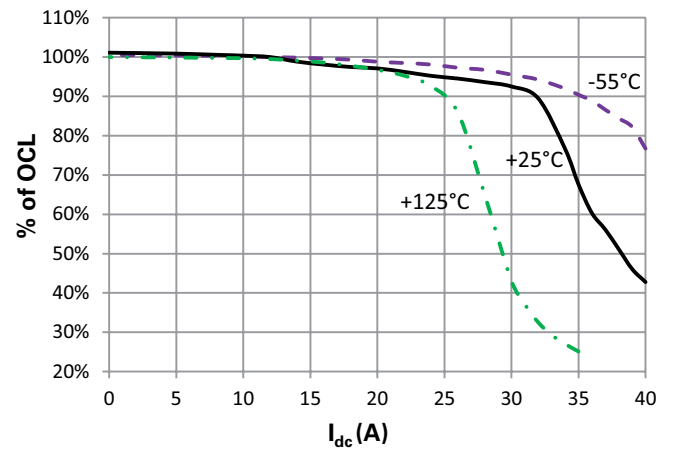

Inductance characteristics

HCV1206-1R5-R

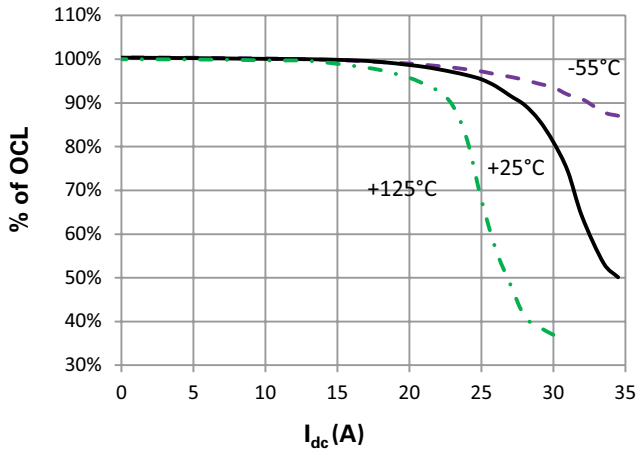

HCV1206-2R0-R

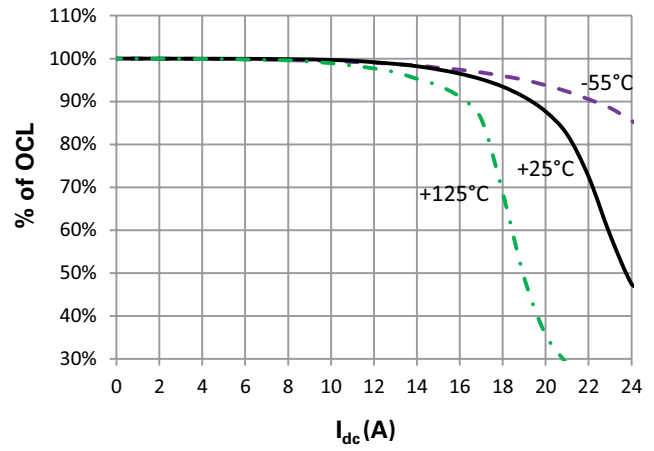

HCV1206-3R0-R

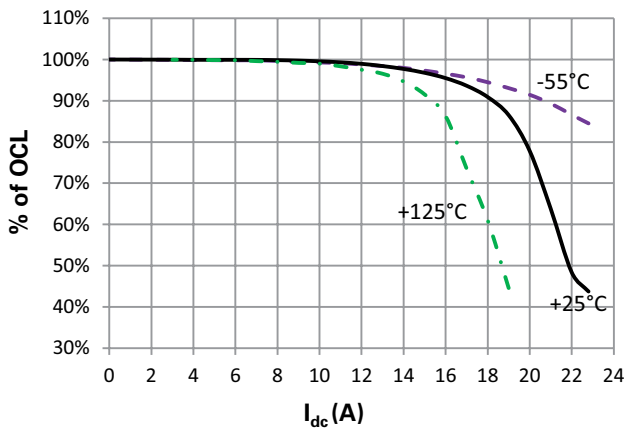

**Solder reflow profile**

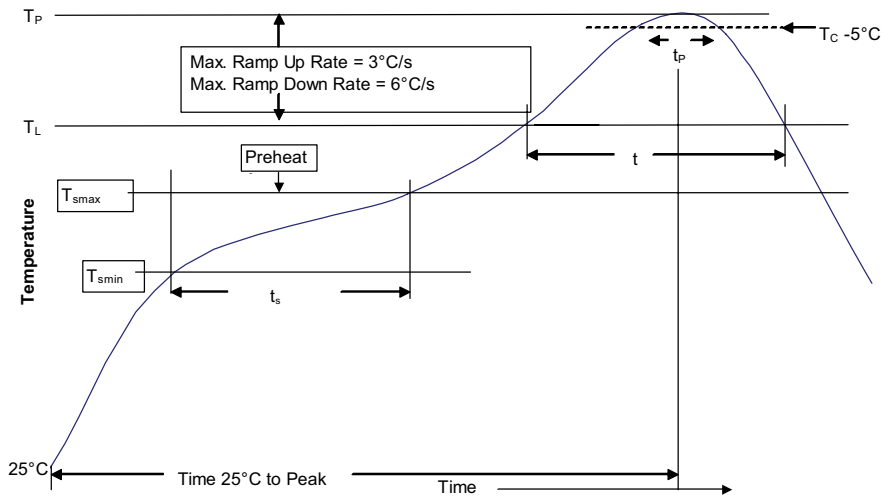

**Table 1 - Standard SnPb Solder ( $T_c$ )**

Package Thickness	Volume $\text{mm}^3$ <350	Volume $\text{mm}^3$ $\geq 350$
<2.5mm)	235°C	220°C
$\geq 2.5\text{mm}$	220°C	220°C

**Table 2 - Lead (Pb) Free Solder ( $T_c$ )**

Package Thickness	Volume $\text{mm}^3$ <350	Volume $\text{mm}^3$ 350 - 2000	Volume $\text{mm}^3$ >2000
<1.6mm	260°C	260°C	260°C
1.6 – 2.5mm	260°C	250°C	245°C
>2.5mm	250°C	245°C	245°C

**Reference JDEC J-STD-020**

Profile Feature	Standard SnPb Solder	Lead (Pb) Free Solder
Preheat and Soak		
• Temperature min. ( $T_{smin}$ )	100°C	150°C
• Temperature max. ( $T_{smax}$ )	150°C	200°C
• Time ( $T_{smin}$ to $T_{smax}$ ) ( $t_s$ )	60-120 Seconds	60-120 Seconds
Average ramp up rate $T_{smax}$ to $T_p$	3°C/ Second Max.	3°C/ Second Max.
Liquidous temperature ( $T_L$ )	183°C	217°C
Time at liquidous ( $t_L$ )	60-150 Seconds	60-150 Seconds
Peak package body temperature ( $T_p$ )*	Table 1	Table 2
Time ( $t_p$ )** within 5 °C of the specified classification temperature ( $T_c$ )	20 Seconds**	30 Seconds**
Average ramp-down rate ( $T_p$ to $T_{smax}$ )	6°C/ Second Max.	6°C/ Second Max.
Time 25°C to Peak Temperature	6 Minutes Max.	8 Minutes Max.

\* Tolerance for peak profile temperature ( $T_p$ ) is defined as a supplier minimum and a user maximum.

\*\* Tolerance for time at peak profile temperature ( $t_p$ ) is defined as a supplier minimum and a user maximum.

Life Support Policy: Eaton does not authorize the use of any of its products for use in life support devices or systems without the express written approval of an officer of the Company. Life support systems are devices which support or sustain life, and whose failure to perform, when properly used in accordance with instructions for use provided in the labeling, can be reasonably expected to result in significant injury to the user.

Eaton reserves the right, without notice, to change design or construction of any products and to discontinue or limit distribution of any products. Eaton also reserves the right to change or update, without notice, any technical information contained in this bulletin.

**Eaton**  
Electronics Division  
1000 Eaton Boulevard  
Cleveland, OH 44122  
United States  
www.eaton.com/electronics

© 2017 Eaton  
All Rights Reserved  
Printed in USA  
Publication No. 10354-BU-SB15161  
October 2017

Eaton is a registered trademark.

All other trademarks are property of their respective owners.