

Fast switching 200 W LLC - Converter

2ED2101S06F & 2ED24427N01F in fast switching application

About this document

Scope and purpose

This user manual provides an overview of the reference design developed for the EVAL 2ED2101 HB-LLC board, including its main features, key data, and mechanical dimensions.

EVAL 2ED2101 HB-LLC is a fast-switching, resonant ZVS 200W LLC-converter power stage with active synchronous rectifier output stage. It is designed to showcase the use of high switching frequencies up to 500 kHz in an LLC converter design, which provide many system benefits such as lower EMI, reduced passive component size and footprint, as well as overall system size and BOM cost.

This evaluation board features the 2ED2101S06F SOI level-shift gate driver for driving the primary-side half bridge and the dual-channel low-side gate driver 2ED24427N01F with pulse transformer to ensure control-signal isolation for the secondary rectifying stage. Also, the 2ED24427N01F is used to drive the synchronous rectification output stage. It includes all of the required elements for an LLC converter, such as the high performance resonant controller ICE2HS01G, IPL60R650P6S 600 V CoolMOS™ P6 transistors, and BSC022N04LS6 OptiMOS™ switches.

The evaluation board demonstrates Infineon's thin-film SOI technology and advanced control for HB-LLC converter with synchronous rectification at the secondary side. For a flexible input DC voltage between 360-425 V, it provides a 12 V output voltage with maximum currents up to 16.7 A. This topology can be used in many DC-DC applications, such as high-power lighting power stages, SMPS, UPS, server supplies, power bricks for consumer electronics, or for low power EV-charging applications (E-Bikes).

Intended audience

This user guide is intended for all technical specialists who are familiar with high-speed DC-DC power stage design and high-power LLC converters. The reference design is intended to be used under laboratory conditions and only by trained specialists.

Evaluation Board

This board is to be used during the design-in phase, for evaluation and measurement of characteristics, and proof of data sheet specifications.

Note: PCB and auxiliary circuits are NOT optimized for final customer design.

Fast switching 200 W LLC - Converter

2ED2101S06F & 2ED24427N01F in fast switching application



About this document

Order Information

The following table contains all important order information.

Base part number	Package	Standard pack		Orderable part number
		Form	Quantity	
EVAL-2ED2101-HB-LLC	EVAL	Boxed	1	EVAL2101HBLLCTOBO1
2ED2101S06F	PG-DSO-8	Tape and reel	2,500	2ED2101S06FXUMA1
2ED24427N01F	PG-DSO-8 (with thermal pad)	Tape and reel	2,500	2ED24427N01FXUMA1
CoolMOS™ IPL60R650P6S	PG-TSON-8 (THINPAK 5X6)	Tape and reel	5,000	IPL60R650P6SATMA1
OptiMOS™ BSC022N04LS	PG-TDSON-8	Tape and reel	5,000	BSC022N04LSATMA1
ICE5QSAG	PG-DSO-8	Tape and reel	2,500	ICE5QSAGXUMA1
ICE2HS01G	PG-DSO-20	Tape and reel	1,000	ICE2HS01GXUMA1

Important notice

Important notice

“Evaluation Boards and Reference Boards” shall mean products embedded on a printed circuit board (PCB) for demonstration and/or evaluation purposes, which include, without limitation, demonstration, reference and evaluation boards, kits and design (collectively referred to as “Reference Board”).

Environmental conditions have been considered in the design of the Evaluation Boards and Reference Boards provided by Infineon Technologies. The design of the Evaluation Boards and Reference Boards has been tested by Infineon Technologies only as described in this document. The design is not qualified in terms of safety requirements, manufacturing and operation over the entire operating temperature range or lifetime.

The Evaluation Boards and Reference Boards provided by Infineon Technologies are subject to functional testing only under typical load conditions. Evaluation Boards and Reference Boards are not subject to the same procedures as regular products regarding returned material analysis (RMA), process change notification (PCN) and product discontinuation (PD).

Evaluation Boards and Reference Boards are not commercialized products, and are solely intended for evaluation and testing purposes. In particular, they shall not be used for reliability testing or production. The Evaluation Boards and Reference Boards may therefore not comply with CE or similar standards (including but not limited to the EMC Directive 2004/EC/108 and the EMC Act) and may not fulfill other requirements of the country in which they are operated by the customer. The customer shall ensure that all Evaluation Boards and Reference Boards will be handled in a way which is compliant with the relevant requirements and standards of the country in which they are operated.

The Evaluation Boards and Reference Boards as well as the information provided in this document are addressed only to qualified and skilled technical staff, for laboratory usage, and shall be used and managed according to the terms and conditions set forth in this document and in other related documentation supplied with the respective Evaluation Board or Reference Board.

It is the responsibility of the customer’s technical departments to evaluate the suitability of the Evaluation Boards and Reference Boards for the intended application, and to evaluate the completeness and correctness of the information provided in this document with respect to such application.

The customer is obliged to ensure that the use of the Evaluation Boards and Reference Boards does not cause any harm to persons or third party property.

The Evaluation Boards and Reference Boards and any information in this document is provided "as is" and Infineon Technologies disclaims any warranties, express or implied, including but not limited to warranties of non-infringement of third party rights and implied warranties of fitness for any purpose, or for merchantability.

Infineon Technologies shall not be responsible for any damages resulting from the use of the Evaluation Boards and Reference Boards and/or from any information provided in this document. The customer is obliged to defend, indemnify and hold Infineon Technologies harmless from and against any claims or damages arising out of or resulting from any use thereof.

Infineon Technologies reserves the right to modify this document and/or any information provided herein at any time without further notice.

Safety precautions

Safety precautions

Note: Please note the following warnings regarding the hazards associated with development systems.

Table 1 Safety precautions





	<p>Caution: Only personnel familiar with the converter, power electronics and associated machinery should plan, install, commission and subsequently service the system. Failure to comply may result in personal injury and/or equipment damage.</p>
	<p>Caution: The heat sink and device surfaces of the evaluation or reference board may become hot during testing. Hence, necessary precautions are required while handling the board. Failure to comply may cause injury.</p>
	<p>Caution: EVAL 2ED2101 HB-LLC evaluation board contains parts and assemblies sensitive to Electrostatic Discharge (ESD). Electrostatic control precautions are required when installing, testing, servicing or repairing the assembly. Component damage may result if ESD control procedures are not followed. If you are not familiar with electrostatic control procedures, refer to the applicable ESD protection handbooks and guidelines.</p>
	<p>Caution: A converter that is incorrectly applied or installed can lead to component damage or reduction in product lifetime. Wiring or application errors such as under sizing the load, supplying an incorrect or inadequate DC supply, or excessive ambient temperatures may result in system malfunction.</p>
	<p>Caution: EVAL 2ED2101 HB-LLC evaluation board is shipped with packing materials that need to be removed prior to installation. Failure to remove all packing materials that are unnecessary for system installation may result in overheating or abnormal operating conditions.</p>

Table of contents

Table of contents

About this document	1
Important notice	3
Safety precautions	4
Table of contents	5
1 EVAL 2ED2101 HB-LLC at a glance	6
1.1 Delivery content	7
1.2 Block diagram.....	8
1.3 Main features	10
1.4 Board parameters and technical data.....	10
2 System and functional description	12
2.1 Commissioning.....	12
2.2 Description of functional blocks.....	12
2.2.1 2ED2101S06F - SOI high-side and low-side gate driver	12
2.2.2 IPL60R650P6S - Primary HV 600 V CoolMOS™ P6 MOSFETs.....	13
2.2.3 ICE2HS01G - LLC analog controller	13
2.2.4 2ED24427N01F- Dual low side driver for synchronous rectifier stage	14
2.2.5 BSC022N04LS6 - Secondary side synchronous rectification OptiMOS™ MOSFET	14
2.2.6 ATWPPQ273230A300P – Transformer construction description.....	14
3 System design	17
3.1 Board schematics.....	17
3.1.1 Main board schematic.....	17
3.1.2 Controller board schematic.....	19
3.1.3 Auxiliary supply board schematic	21
3.2 Layout	23
3.3 Bill of material	25
4 System performance	33
4.1 Power-up and test procedure.....	33
4.1.1 Test points and measurement conditions	33
4.1.2 Test procedure	33
4.2 Board operation	36
4.2.1 ZVS behavior analysis	36
4.2.2 Burst mode operation.....	37
4.2.3 LLC operation – soft and hard commutation.....	38
4.2.4 Synchronous rectification.....	39
4.3 Measurements and efficiency	40
4.3.1 Temperature measurements.....	40
4.3.2 Overall efficiency.....	42
5 References and appendices	45
5.1 Abbreviations and definitions.....	45
5.2 References	45
5.3 Additional information.....	46
Revision history	47

Fast switching 200 W LLC - Converter

2ED2101S06F & 2ED24427N01F in fast switching application

EVAL 2ED2101 HB-LLC at a glance

1 EVAL 2ED2101 HB-LLC at a glance

The LLC converter is a topology which offers many benefits within the isolated DC-DC converter family. The commonly used zero-voltage switching (ZVS) of the resonant tank features low electromagnetic interference (EMI) while enabling high power density and high efficiency. An increasing need in cheap, efficient and compact power supplies drives further development in the area of power density increase. Especially in applications such as chargers for eBikes, power bricks for consumer electronics, SMPS, UPS, server power supplies or in lighting applications, for which system size is an important factor. Another trend accompanying the increase of battery-driven vehicles and tools is the increase in power demand for LLC converters. In higher power applications, LLC becomes the dominant topology for isolated DC-DC converters (Figure 1).

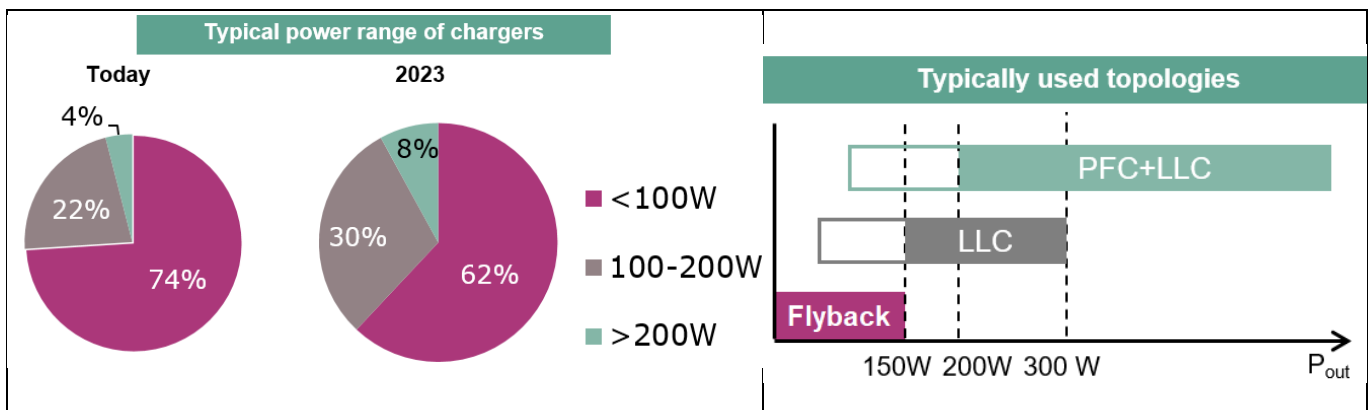

Figure 1 Power demand increase for chargers

A common way of reducing the size and cost of an LLC inverter is by increasing the switching frequency, f_{sw} , of the resonant tank. When using higher switching frequency, passive component size can be decreased. In an LLC design, bulky passive components such as the transformer, cooling heatsink and capacitances are major design and cost factors for the whole system.

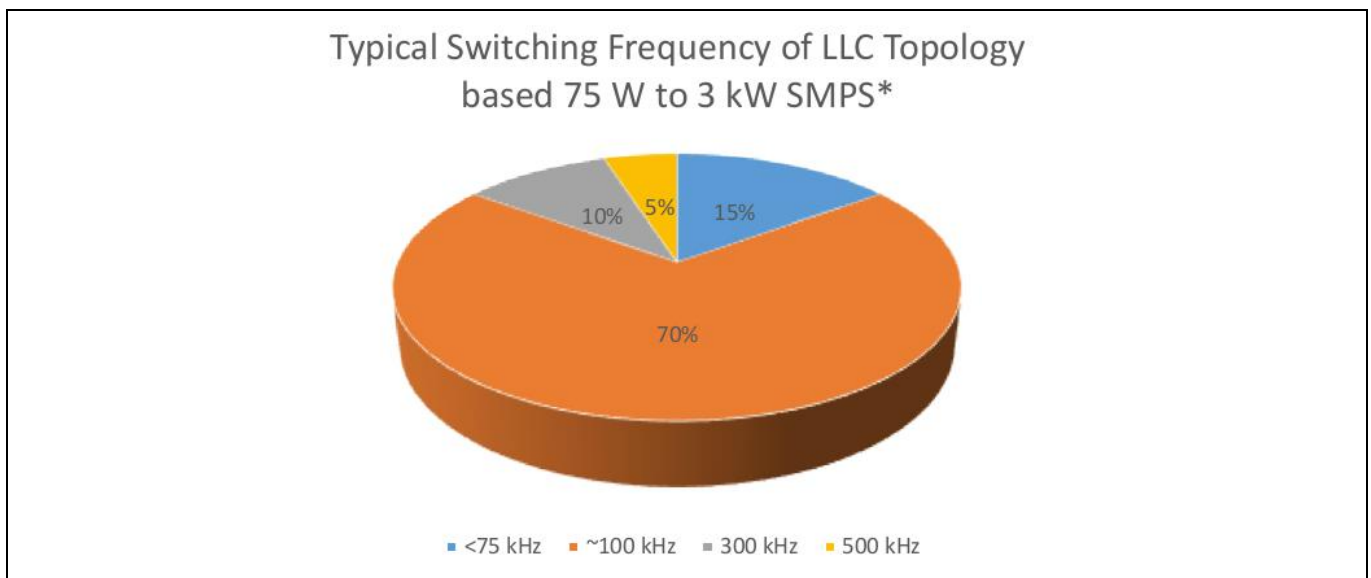

Figure 2 State of the art: share of high switching frequency LLC converters

Most of the commercially sold LLC converters use switching frequencies up to 300 kHz (see Figure 2). A bottleneck for increasing the switching frequency are the gate drivers for driving the primary-side MOSFET in

Fast switching 200 W LLC - Converter

2ED2101S06F & 2ED24427N01F in fast switching application

EVAL 2ED2101 HB-LLC at a glance

the half-bridge or full-bridge topologies. Cost pressure and tight space requirements favor level-shift gate driver ICs over isolated technologies for properly controlling the switching behavior. [1] Standard junction-isolation-based level shifter ICs are often not suited for switching frequencies above 300 kHz (Figure 3). Parasitic structures and internal losses cause self-heating and finally, destruction of the IC.

Recent developments by Infineon in IC technology for level-shift gate drivers, namely the silicon-on-insulator (SOI) technology, enable high speed switching frequencies in the 500 kHz range by reducing parasitic structures, increasing robustness against negative VS spikes and reduced level-shift losses. [2]

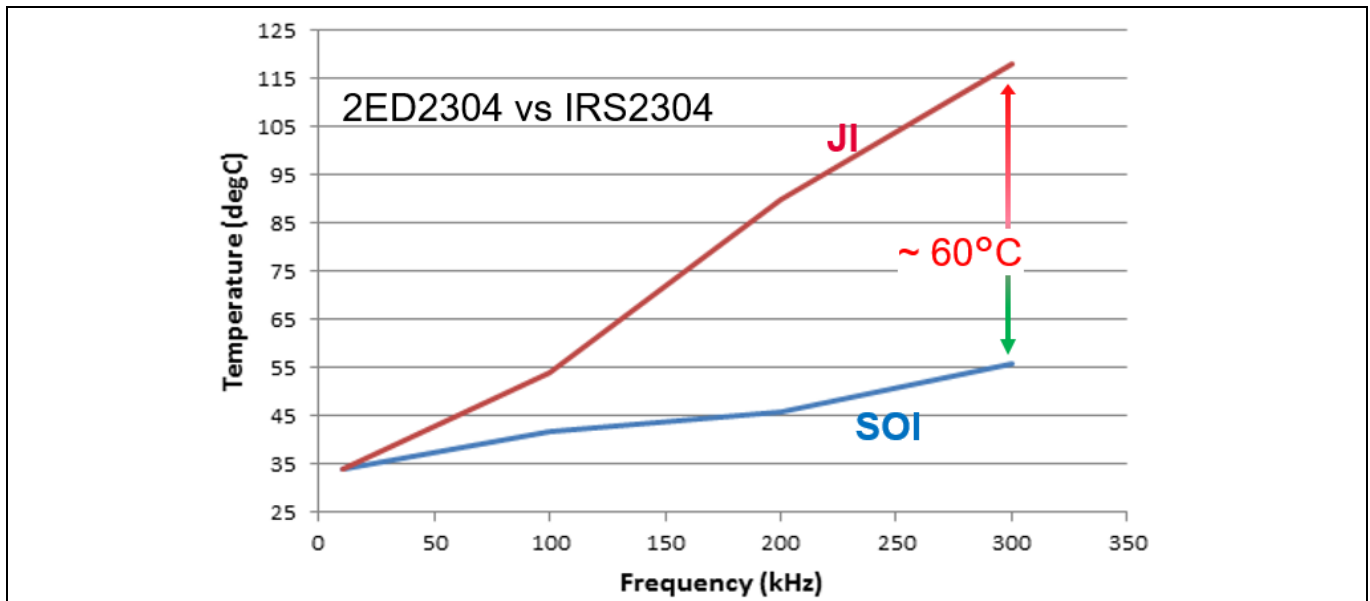

Figure 3 Self-heating: Junction- Isolation (IRS2304) vs SOI (2ED2304) - 300 V_{DC} for P7 CoolMOS™ in D-Pak

The EVAL 2ED2101 HB-LLC is an evaluation board to demonstrate the switching performance of the SOI high-side and low-side gate driver 2ED2101S06F in fast-switching LLC power stages with resonant-tank switching frequencies in the 500 kHz range. It allows for fast customer prototyping and short time to market for faster market entry. The EVAL 2ED2101 HB-LLC evaluation board is available through regular Infineon distribution partners as well as on Infineon's website. The main features of this board are described in this document, whereas the remaining paragraphs provide information to enable the customers to copy, modify, and qualify the design for production according to their own specific requirements.

The evaluation board is not qualified in terms of safety requirements or manufacturing and operation over the whole operating temperature range or lifetime. Reference designs are intended to be used under laboratory conditions by functional and performance testing only. They are not subject to the same procedures as regular products regarding returned material analysis (RMA), process change notification (PCN) and product discontinuation (PD).

1.1 Delivery content

The delivery includes the finished board as shown in Figure 4 and Figure 5. The EVAL 2ED2101 HB-LLC consists of a main board, a separate auxiliary supply board and a controller board. This enables users to simply use existing microcontroller infrastructures and connect their own control signals via the controller connector X5 for the primary-side control signals and X8 for the synchronous-rectifier control signals.

Fast switching 200 W LLC - Converter

2ED2101S06F & 2ED24427N01F in fast switching application

EVAL 2ED2101 HB-LLC at a glance

Additionally, the auxiliary supply board can be replaced by one's own supply lines. They can be connected at headers X9 and X10. The signal description for each pin of these connectors can be found at the bottom side of the main board PCB.

1.2 Block diagram

The block diagram of EVAL 2ED2101 HB-LLC is depicted in Figure 4, which contains the high-performance resonant controller ICE2HS01G, IPL60R650P6S 600 V CoolMOS™ P6 transistors in the primary-side half-bridge and BSC022N04LS6 OptiMOS™ switches in the synchronous-rectifier stage.

This reference design includes:

- Gate driver IC for primary-side MOSFETs
- Isolated DC-DC power stage
- Synchronous rectifier stage
- 13 V auxiliary power supply
- Separate ICE2HS01G resonant controller board
- Connectors for easy setup of own primary side controller

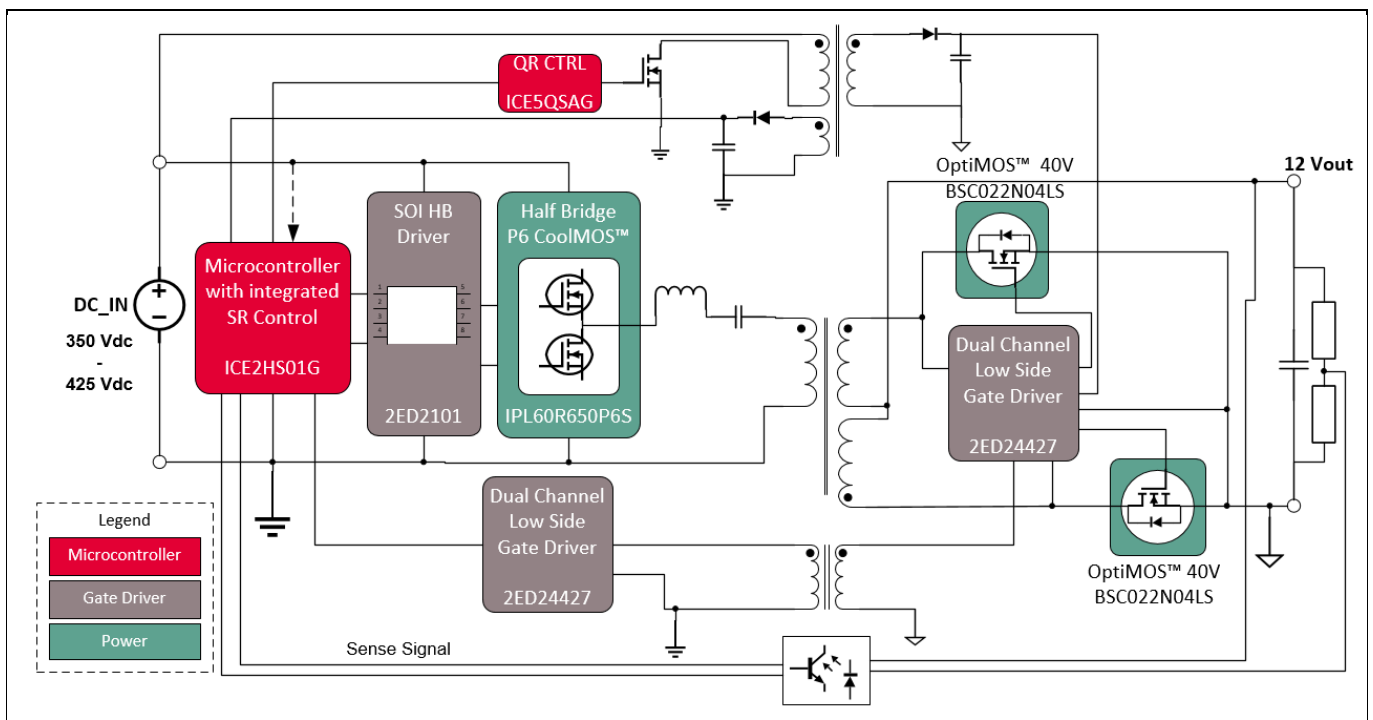

Figure 4 Block diagram of the EVAL 2ED2101 HB-LLC

Fast switching 200 W LLC - Converter

2ED2101S06F & 2ED24427N01F in fast switching application

EVAL 2ED2101 HB-LLC at a glance

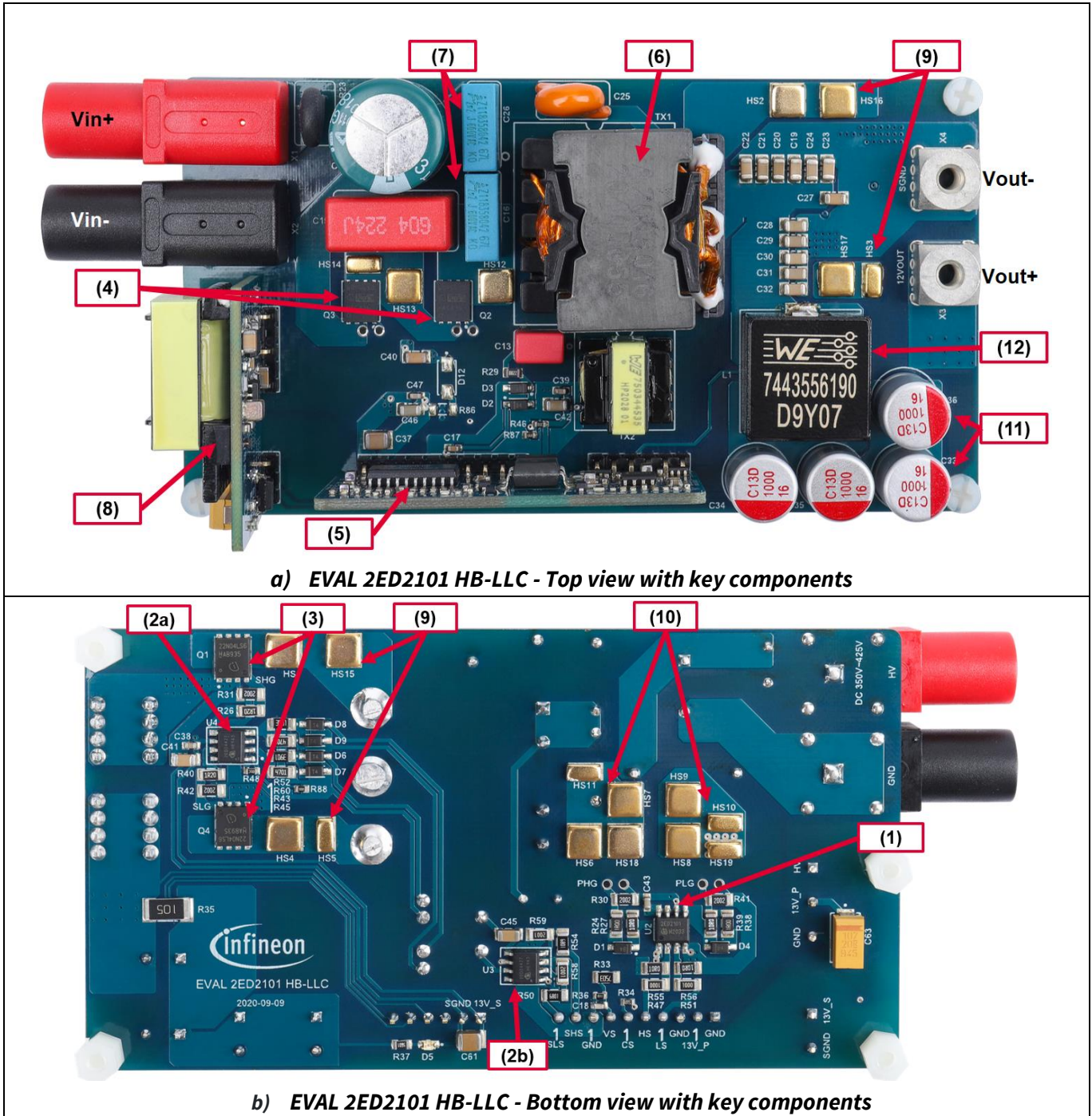

Figure 5 EVAL 2ED2101 HB-LLC - PCB board views

Further key components can be found with the following designators:

- (1) High-side and Low-side SOI gate driver 2ED2101S06F
- (2a) Synchronous rectification driver 2ED24427N01F – dual-channel, low-side driver
- (2b) Pulse transformer driver 2ED24427N01F – dual-channel, low-side driver
- (3) Synchronous rectifier switches OptiMOS™ BSC022N04LS6
- (4) Primary side switches IPL60R650P6S
- (5) LLC analog controller ICE2HS01G with integrated synchronous rectification control
- (6) Main transformer ATWPPQ273230A300P-00 from Sunlord
- (7) Resonant capacitor

Fast switching 200 W LLC - Converter

2ED2101S06F & 2ED24427N01F in fast switching application

EVAl 2ED2101 HB-LLC at a glance

- (8) PCB assembly of the auxiliary circuit with bias QR flyback controller ICE5QSAG
- (9) Heatsink assembly for cooling the synchronous rectifiers
- (10) Heatsink assembly of primary side switches IPL60R650P6S
- (11) Output capacitors
- (12) Output inductor

1.3 Main features

The EVAl 2ED2101 HB-LLC evaluation board design characteristics include:

- Input voltage 350 - 425 VDC
- Maximum 200 W at 16.7 A, 400 VDC power input, air-flow cooling sufficient
- Overcurrent protection
- Power-up LED reporting
- Controller board with ICE2HS01G
- Auxiliary power supply with isolated 13 V and 5 V for secondary side supply
- PCB is 65 mm × 137 mm, 4 layers, 2 oz. copper
- RoHS compliant

1.4 Board parameters and technical data

Table 2 depicts the key specifications of the reference design used in the EVAl 2ED2101 HB-LLC.

Table 2 EVAl 2ED2101 HB-LLC board specifications

Parameters	Values	Conditions / comments
Input		
DC voltage	350 - 425 V _{DC}	Start-up hysteresis, turn-on at 372 V _{DC}
Input current	Max 0.65 A _{rms}	Input 380 V _{DC} , T _{AMB} =25°C,
Output		
Power	200 W	Input 425 V _{DC} , I _{LOAD} = 16.7 A ; f _{PWM} = 417 kHz, T _{AMB} = 25°C, T _{2ED2101S06F} = 81°C
Output Voltage	12 V _{DC}	Ripple < 5%
Minimum current	1 A _{rms}	Input 400 V _{DC} , f _{PWM} = 456 kHz, T _{AMB} = 25°C, T _{2ED2101S06F} = 68°C
Maximum current	16.7 A _{rms}	Input 380 V _{DC} , f _{PWM} = 380 kHz, T _{AMB} = 25°C, T _{2ED2101S06F} = 75°C
Switching frequency		
Maximum inverter switching frequency f _{PWM}	500 kHz	Input 425 V _{DC} , I _{LOAD} = 1 A, T _{AMB} = 25°C, T _{2ED2101S06F} = 48°C
Minimum inverter switching frequency f _{PWM}	347 kHz	Input 350 V _{DC} , I _{LOAD} = 16.7 A, T _{AMB} = 25°C, T _{2ED2101S06F} = 80°C
On-board power supply		
13 V	13 V ± 2%, max. 200 mA	Non-isolated for primary side

Fast switching 200 W LLC - Converter

2ED2101S06F & 2ED24427N01F in fast switching application



Eval 2ED2101 HB-LLC at a glance

Parameters	Values	Conditions / comments
5 V	5 V \pm 2%, max. 200 mA	Reference voltage for ICE2HS01G controller
Auxiliary power supply		
13 V	13 V \pm 2%, max. 200 mA	Isolated for secondary side
5 V	5 V \pm 2%, max. 200 mA	Isolated reference voltage for secondary side
PCB characteristics		
Material	FR4, 2.00 mm, 2oz PCB	4 layers
Dimension	65 mm \times 137 mm	
System environment		
Ambient temperature	Typical 25°C	Non-condensing, maximum RH of 95%

2 System and functional description

2.1 Commissioning

Some initial steps have to be taken to set up the EVAL 2ED2101 HB-LLC. In this document, the EVAL 2ED2101 HB-LLC is assumed to be used with the provided auxiliary power supply board and the ICE2HS01G controller board as described in chapter 1.2. Both boards need to be installed in the respective connectors (X5, X8, X9 and X10) as can be seen in Figure 5 .

Before conducting tests on the board, a high-power supply must be connected to the input connectors X1 and X2, with regards to correct polarity. At the load side (connector X3 and X4) either an electrical load or a resistive matrix should be used for testing. Besides, the power supply and load need to fulfil the following minimum requirements:

- High voltage power supply (min. 430 VDC, 1 A current capability)
- Resistive Load: max. 16.7 A load current (electric load) or 0.71 Ω total resistance

Please be reminded that high power is used and the board should only be operated by trained users.

Description of the functional blocks

2.2 Description of functional blocks

2.2.1 2ED2101S06F - SOI high-side and low-side gate driver

Developers of consumer electronics and home appliances strive continuously for higher efficiency of applications and smaller form factors. One area of interest in power supply design is the switching behavior and power losses of new power MOSFETs, such as the latest generations of CoolMOS™ with dramatically reduced gate charges, as dedicated driver ICs can optimize it.

The 2ED2101S06F high-side and low-side driver IC is one of the fastest switching drivers from Infineon's 2ED EiceDRIVER™ Compact 650 V gate driver IC family with monolithic integrated low-ohmic and ultrafast bootstrap diode [3]. Its level-shift SOI-technology supports higher efficiency and smaller form factors of applications. Based on the used SOI-technology there is an excellent ruggedness on transient voltages. No parasitic thyristor structures are present in the device. Hence, no parasitic latch-up may occur at any temperature and voltage conditions. The outputs of the two independent drivers are controlled at the low side using two different CMOS or LSTTL-compatible signals, down to 3.3 V logic. The device includes an undervoltage detection unit with hysteresis characteristic, which is optimized for either IGBT or MOSFET.

The part is recommended for server/telecom SMPS, low-voltage drives, e-bike, battery charger and half bridge based switch mode power supply topologies.

- Simple, low-cost solution to drive MOSFETs or IGBTs up to 650 V
- Reduced level-shift losses for switching frequencies above 100 kHz, tailored for high-frequency applications
- Lower system BOM cost with integrated, monolithic bootstrap diode enabling bootstrap voltage up to 675 V
- Highest reliability and quickest time to market with superior negative VS immunity of -100V
- Superior latch-up immunity with SOI
- Integrated ultrafast, low R_{DS(on)} bootstrap diode
- I_{o+} / I_{o-} = 0.29 A / 0.7 A drive current (typical)
- Independent, dual-channel undervoltage lockouts (UVLO)
- Supports maximum supply voltage of 25 V
- Form, fit, function, pin-to-pin, and electrically compatible with earlier generation drivers

System and functional description

2.2.2 IPL60R650P6S - Primary HV 600 V CoolMOS™ P6 MOSFETs

The 600 V CoolMOS™ P6 is a new addition to Infineon's market-leading high-voltage CoolMOS™ portfolio. It is the sixth technology platform of high-voltage power MOSFETs designed according to the revolutionary super junction principle. This new and highly innovative product family is designed to enable higher system efficiency whilst being easy to design in.

In LLC applications, the converter is in resonant operation with guaranteed ZVS even at a very light load condition. Switching loss caused by E_{oss} during turn-on can be considered negligible in this topology. With this consideration, CoolMOS™ P6 offers superior price/performance ratio with low FOMs ($R_{on} \cdot Q_g$ and $R_{on} \cdot Q_{oss}$), which means that MOSFET switching transitions can occur in a shorter dead time period. This will result in lower turn-off losses, pushing further the efficiency. The following are the additional features and benefits of CoolMOS™ P6 making it suitable and advantageous for resonant switching topologies like LLC:

- Reduced gate charge (Q_g) improves the efficiency especially in light load conditions due to a lower power requirement
- Lower Q_{oss} reduces the turn-on and turn-off time for a better usage of ZVS window
- Optimized gate threshold voltage (V_{th}) lowers the turn-off losses in soft switching applications
- Optimized integrated R_g ensures an optimum balance between efficiency and good controllability of the switching behavior
- Improved dv/dt compared to previous technologies assures high robustness
- Good body diode ruggedness
- Outstanding reliability with proven CoolMOS™ quality

2.2.3 ICE2HS01G - LLC analog controller

Infineon ICE2HS01G is a high-performance resonant-mode controller designed especially for high efficiency half-bridge or full-bridge LLC resonant converters with synchronous rectification at the secondary side. With its new driving techniques, the synchronous rectification can be realized for LLC converters operated with secondary switching current in both CCM and DCM conditions. No special synchronous rectification controller IC is needed at the secondary side. The maximum switching frequency is supported up to 1MHz. Except for the patented SR driving techniques, this IC provides a very flexible design and integrates full protection functions as well. It is adjustable for maximum/minimum switching frequency, soft-start time and frequency, dead time between primary switches, turn-on and turn-off delay for secondary SR MOSFETs. The integrated protection mechanisms include input voltage brownout, primary three-level overcurrent, secondary overload protection and no-load regulation.

- Resonant mode controller for half-bridge LLC resonant converter with synchronous rectification drives
- 30 kHz to 1 MHz switching frequency
- Adjustable minimum switching frequency with high accuracy
- 50% duty cycle for both primary and secondary gate drives
- Adjustable dead time with high accuracy
- Driving signal for synchronous rectification which supports full operation of LLC resonant converter
- Internal and external disable function for synchronous rectification
- Mains input undervoltage protection with adjustable hysteresis
- Three levels of overcurrent protection for enhanced dynamic performance
- Open-loop/overload protection with adjustable blanking time and restart time
- Adjustable over-temperature protection with latch-off
- External latch-off enable pin

System and functional description

2.2.4 2ED24427N01F- Dual low side driver for synchronous rectifier stage

EiceDRIVER™ 24 V dual-channel low-side non-inverting gate driver for MOSFETs or IGBTs with typical 10 A source and sink currents in a DSO-8 package with thermally efficient, exposed power pad. 2ED24427N01F enables higher power and faster switching frequencies in multiple applications with a reduced PCB footprint and increased reliability by simplifying high-power density system design.

The 2ED24427N01F is a low-voltage, power MOSFET and IGBT non-inverting gate driver. Proprietary latch-immune CMOS technologies enable ruggedized monolithic construction. The logic input is compatible with standard CMOS or LSTTL output. The output driver features a current buffer stage. The output drivers feature a high-pulse current buffer stage designed for minimum driver cross-conduction. Propagation delays between two channels are matched. Internal VCC circuitry provides undervoltage lockout protection that holds output low until VCC supply voltage is within the operating range.

Strongest gate drive per channel:

- Typical ± 10 A, maximum +17 A / -11 A
- 24 V maximum supply voltage
- 55 ns maximum propagation delay
- Enable function
- PSOIC8 package with thermal pad
- Smaller thermal resistance
- $R_{\theta_{JC}} = 4^{\circ}\text{C}/\text{W}$
- Dissipates 2X the power of regular DSO-8 package
- For IGBT, and MOSFET

2.2.5 BSC022N04LS6 - Secondary side synchronous rectification OptiMOS™ MOSFET

For the synchronous rectification (SR) stage, the selected device is BSC022N04LS6, from the latest OptiMOS™ 40 V Family. SR is in fact the best choice in high-efficiency designs of low output voltage and high output current e.g. LLC converter, as in our case. In applications that target high efficiency both at light and heavy load while often requiring high power densities, it is critical to select a high-quality SR MOSFET. The BSC022N04LS6 features the following key characteristics:

- Optimized for synchronous rectification
- Increased power density: 31% improvement of FOM over similar devices
- Very low voltage overshoot
- 15% lower RDS (on) than alternative devices
- Low gate charge Qg, which is important to minimize driving losses, with benefits for light load efficiency
- Monolithically integrated Schottky-like diode to minimize the conduction losses

2.2.6 ATWPPQ273230A300P – Transformer construction description

The transformer is one of the key components in any LLC design. For the design in this example a transformer from Sunlord Inc was chosen. The key parameters are described in this chapter. For a detailed design analysis please refer to the Infineon Application Note [3]. Here a detailed approach of how to select the right core material, winding ratio etc. is described.

- Core and materials: Mn-Zn Ferrite DMR50

Fast switching 200 W LLC - Converter

2ED2101S06F & 2ED24427N01F in fast switching application

System and functional description

- Bobbin: Phenolic (7-pin, THT, horizontal version)
Primary inductance: $L_p = 168 \mu\text{H}$ (± 3 percent), measured between pin 1 and pin 5
- Manufacturer and part number: Sunlord (ATWPPQ273230A300P)
- Operating temperature: -40°C to $+125^\circ\text{C}$

No.	Part Name	Material Name
①	Core	Mn-Zn Ferrite DMR50 or Equivalent Material
②	Wire	Pri: Mylar Wire $\varnothing 0.1\text{mm} \times 35\text{P}$ Sec: Mylar Wire $\varnothing 0.1\text{mm} \times 250\text{P}$
③	Glue	Epoxy
④	Tape	Polyester Tape
⑤	Pin	CP Wire
⑥	Bobbin	Phenolic

Structure and Material

Note : For RoHS Compliant Products:
 1.Solder : Sn /Ag /Cu .
 2.Marking Code:A2005016
 3.Date Code: ** ** **
 ① ② ③

① Year
 ② Week
 ③ Trace Code

Shape and Dimensions

Recommended PCB pattern

Item	A	B	C	D	E	F
Sunlord Spec.	28.0Max.	31.5Max.	29.5Max.	5.5 \pm 0.5	25.0 \pm 0.3	5.0 \pm 0.2
Item	G	H	J	K		
Sunlord Spec.	20.0 \pm 0.3	1.0 \pm 0.2	2.4 Ref	3.4 Ref		

Shape and Dimensions

Fast switching 200 W LLC - Converter

2ED2101S06F & 2ED24427N01F in fast switching application



System and functional description

Sunlord P/N: ATWPPQ273230A300P

Parameters	Inductance	Inductance	DCR		HI-POT		TURNS RATIO
Unit	uH	uH	mΩ Max	mΩ Max	/		Ts
Test Terminal	Pin(1,2-4,5)	Pin(1,2-4,5),shorted all other pins	Pin(1,2-4,5)	Pin(8-6)	Winding to Winding	Winding to Core	Pin(1,2-4,5):Pin(7- 6):Pin(8-7)
Sunlord Design	168± 3%	39± 5%	220	6	3500Vac / 2s/2mA/50Hz	1000Vac / 2s/2mA/50Hz	32:2:2±0.5
Test Condition	Measured at 400KHz,1V, 25° C	Measured at 400KHz,1V, 25°C	Measured at 25°C		Measured at 25°C		Measured at 15.75KHz,1V, 25°C

Electrical parameters

Figure 6 Transformer description

System design

3 System design

EVAL 2ED2101 HB-LLC is a reference design for 200 W LLC converter for, but not limited to, lighting applications, server power supplies or low-power EV-charging applications, such as e-Bike chargers.

3.1 Board schematics

The EVAL 2ED2101-LLC consists of three different boards: the main board, the auxiliary power supply board, and the controller board featuring the ICE2HS01G - LLC analog controller.

The BOMs for the respective boards can be found in the Appendix in section 3.3.

3.1.1 Main board schematic

The main board schematic consists of three stages. Figure 7 unterhalb shows the DC-DC power stage including the synchronous rectifier output. The 2ED2101S06F can be used with an optional external bootstrap resistor and diode structure to provide the ideal gate driving signals for turn-on and turn-off of each half-bridge MOSFET respectively. In the standard assembly the external network is not used, since the integrated bootstrap diode of the 2ED2101S06F is able to supply the high side for switching frequencies up to 600 kHz.

Fast switching 200 W LLC - Converter

2ED2101S06F & 2ED24427N01F in fast switching application

System design

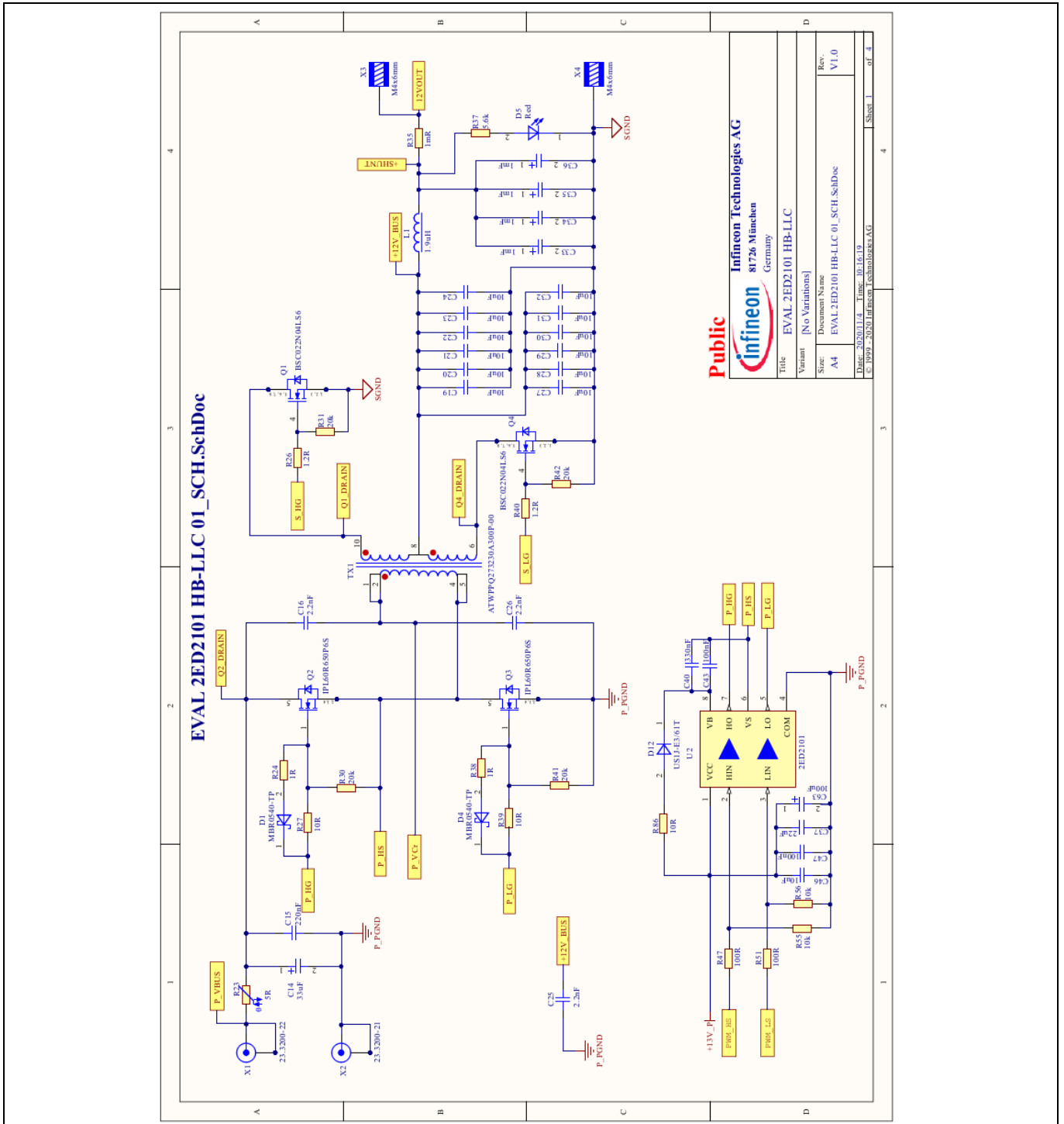

Figure 7 EVAL 2ED2101 HB-LLC: main board schematic – power stage with 2ED2101S06F

In Figure 8 unterhalb the signal transmission from primary to secondary isolation side for the control signals of the synchronous rectifier stage is shown. Here the 2ED24427N01F is used as a transformer driver first, as well as a driving stage for the SR stage. Besides that, this schematic sheet also covers the sense networks for the primary side control signals of the bus voltage and the current sense. These signals are fed back to the ICE2HS01G controller in order to achieve best closed loop control for switching cycle regulation.

Fast switching 200 W LLC - Converter

2ED2101S06F & 2ED24427N01F in fast switching application

System design

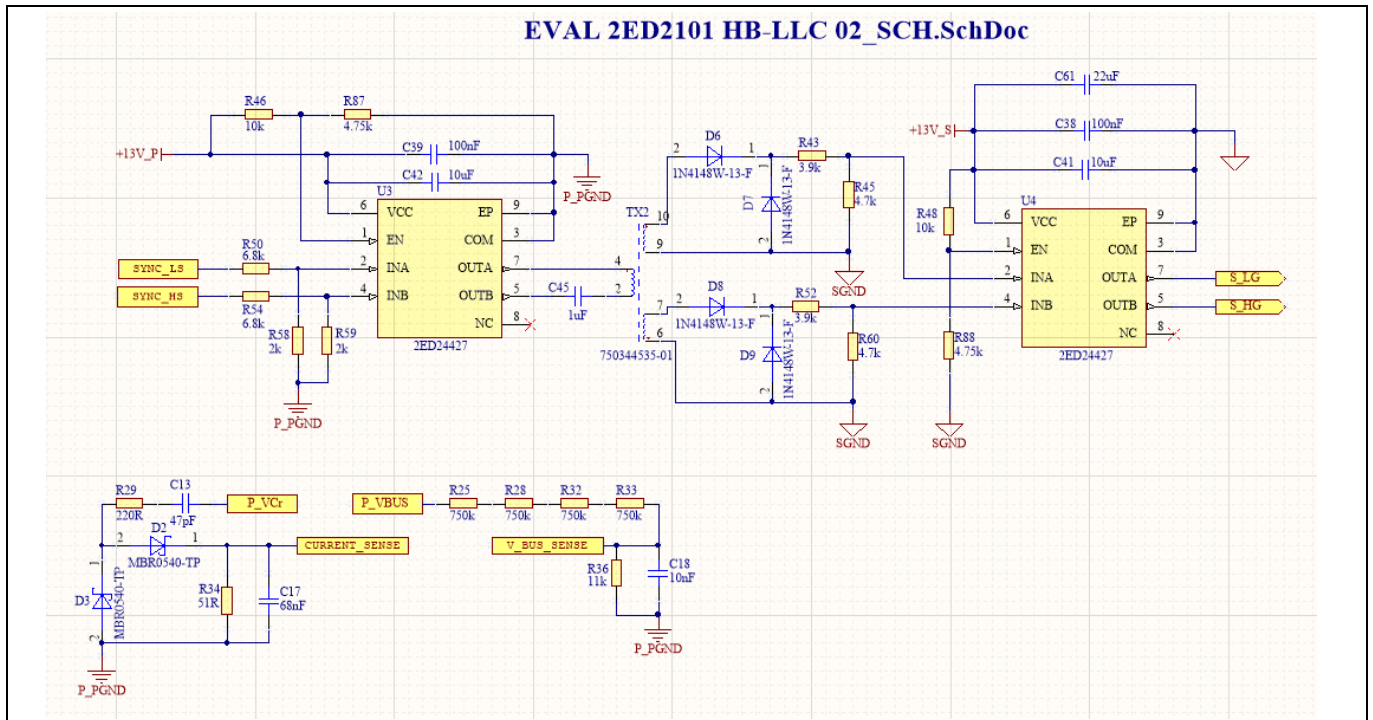

Figure 8 EVAL 2ED2101 HB-LLC: main board schematic – synchronous rectifier control with 2ED24427N01F

The third schematic sheet of the main board covers the passive components like heatsinks and connectors. It is shown in Figure 9 unterhalb.

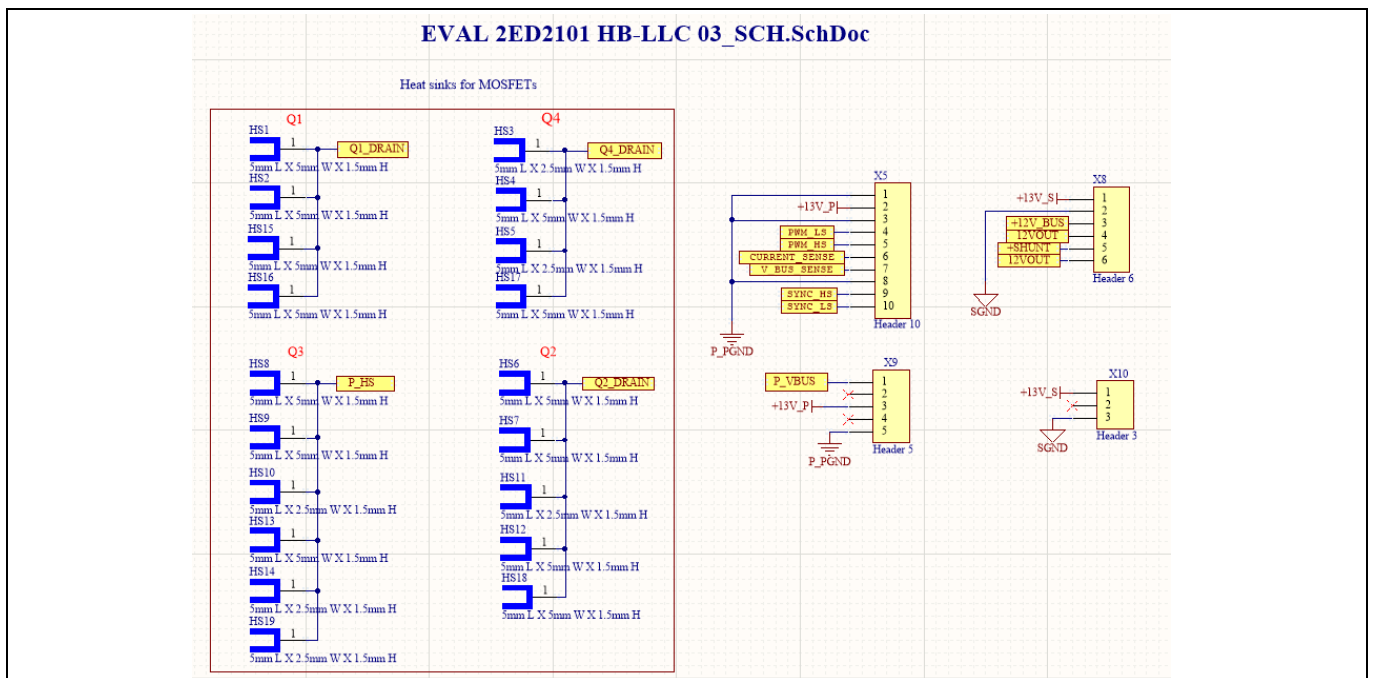

Figure 9 EVAL 2ED2101 HB-LLC: main board schematic- heatsinks and connectors

3.1.2 Controller board schematic

The controller board schematic in Figure 10 unterhalb shows the ICE2HS01G analog control and its parameter settings with external resistors and capacitors. Here great care was taken to enable switching frequency control

Fast switching 200 W LLC - Converter

2ED2101S06F & 2ED24427N01F in fast switching application



System design

as high as 500 kHz and burst operation to 600 kHz under light load operation. More information on how to control the ICE2HS01G with external components can be found in [5]. Besides the analog system settings, the first sheet includes the network for isolation bridging of the regulation feedback signal.

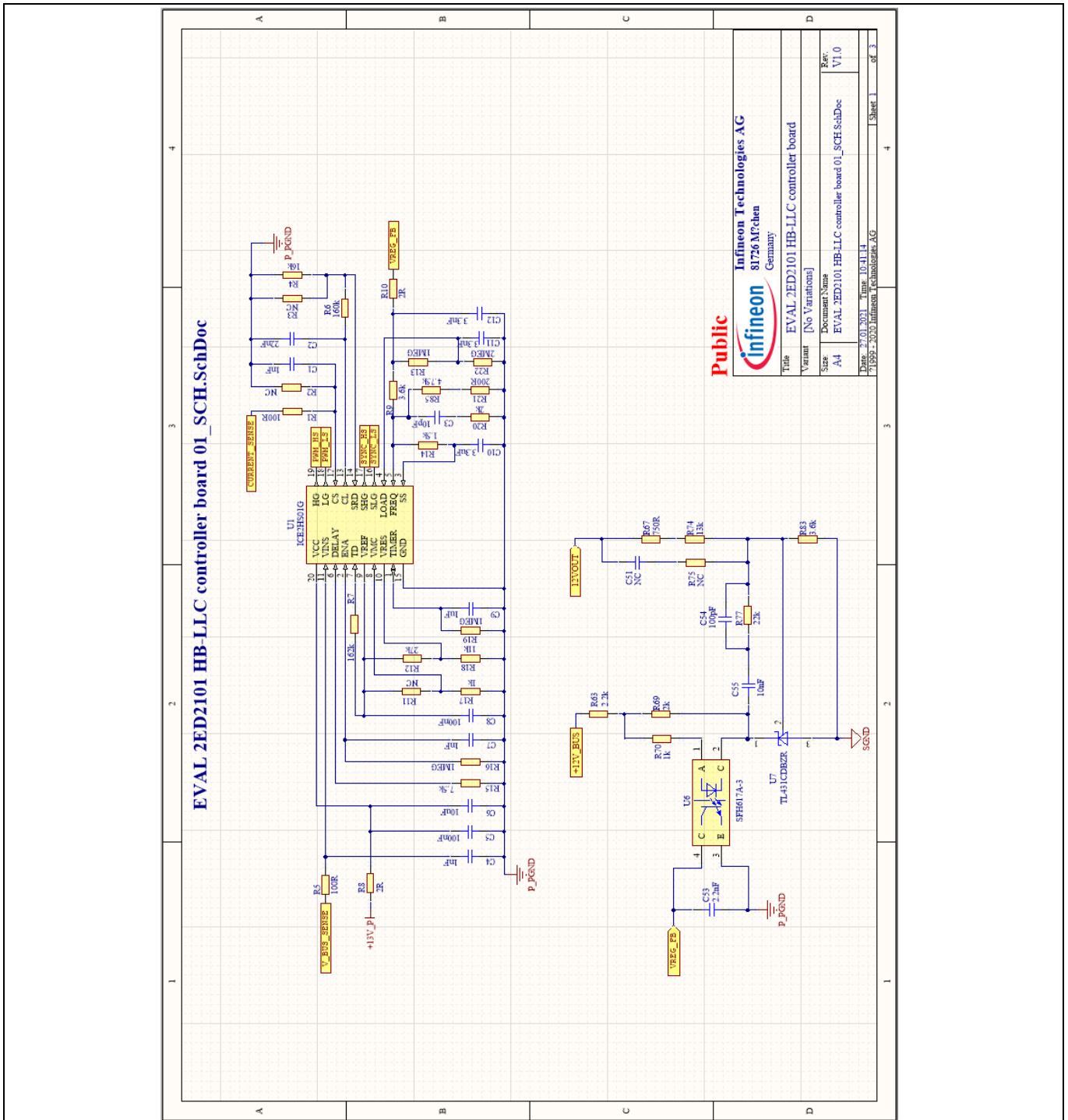

Figure 10 EVAL 2ED2101 HB-LLC: Controller Board Schematic – discrete ICE2HS01G

The second sheet of the controller board in Figure 10 oben covers the signal isolation via optocouplers for overcurrent protection and output overvoltage protection of the output. A 1 mΩ shunt resistor is used to monitor the output current. Once the output current is higher than 19.5 A, or the output voltage is higher than 13.8 V, the transistor Q5 turns on and the voltage on the sense pins of ICE2HS01G is pulled down to GND. This causes an immediate operational shut-down of ICE2HS01G.

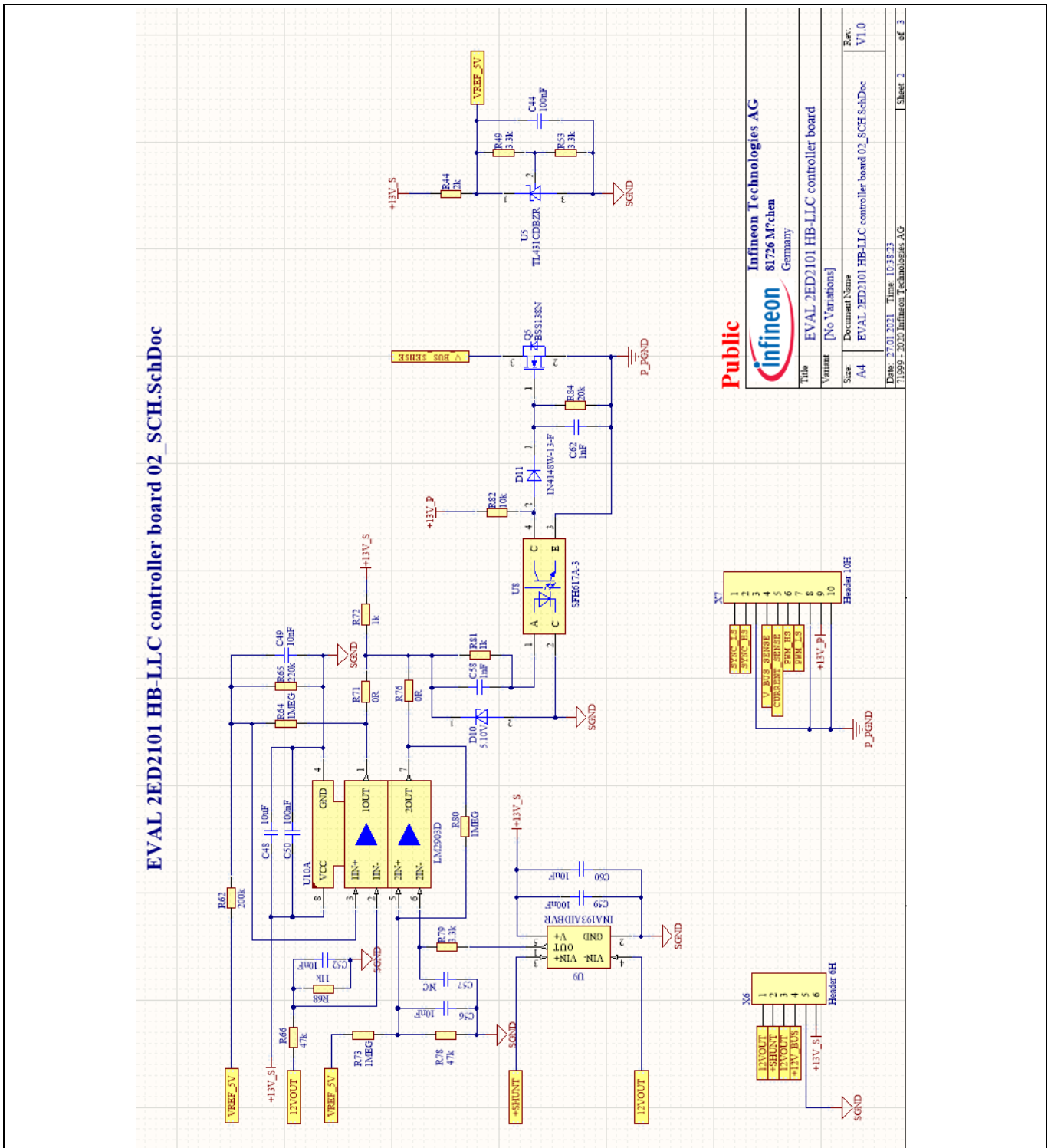

Figure 11 EVAL 2ED2101 HB-LLC: Controller board schematic – connectors and amplifier stages

3.1.3 Auxiliary supply board schematic

The auxiliary supply board features the ICE5QSAG as quasi resonant controller for power transmission of the power transformer. The rectification network regulates the voltage to 13 V, which is needed to supply the secondary output side of the main inverter board. A red LED is used as an indicator for correct power level and ready-to-start signal for the user.

Public

Infineon Technologies AG
81726 Muenchen
Germany

Title	EVAL 2ED2101 HB-LLC controller board	Rev.
Variant	[No Variations]	
Size	Document Name	V1.0
A4	EVAL 2ED2101 HB-LLC controller board 02_SCH.SchDoc	

Days: 31.01.2021 Time: 10:48:23
71959 - 2020 Infineon Technologies AG Sheet 2 of 3

Fast switching 200 W LLC - Converter

2ED2101S06F & 2ED24427N01F in fast switching application

System design

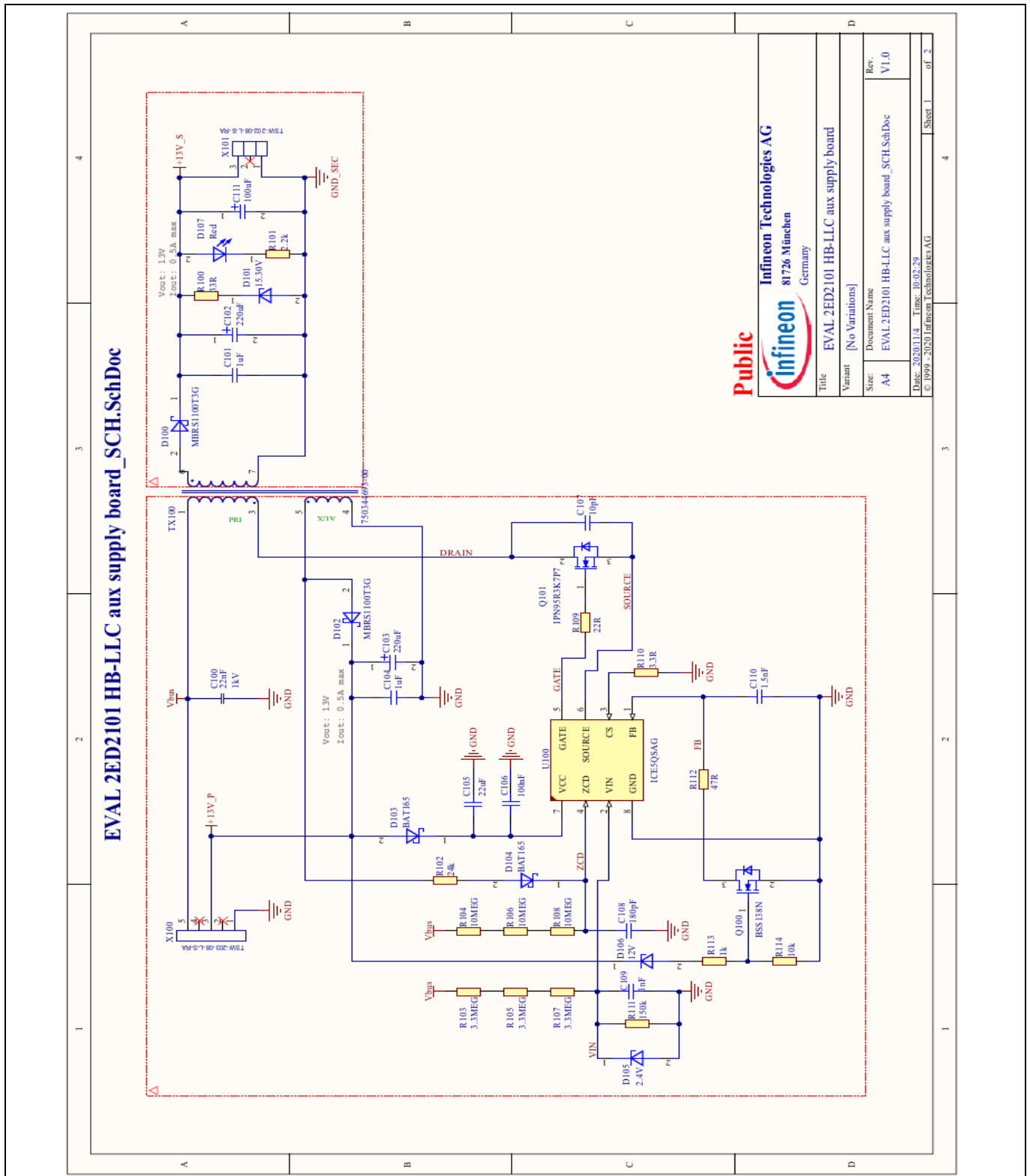

Figure 12 EVAL 2ED2101 HB-LLC: Auxiliary supply board schematic

System design

3.2 Layout

This board has four electrical layers with 70 μm copper (2 oz. copper) and dimensions are 65 mm \times 137 mm. The thickness of the PCB board is 1.6 mm. Figure 30 and Figure 31 illustrate the top and bottom layers of the reference design.

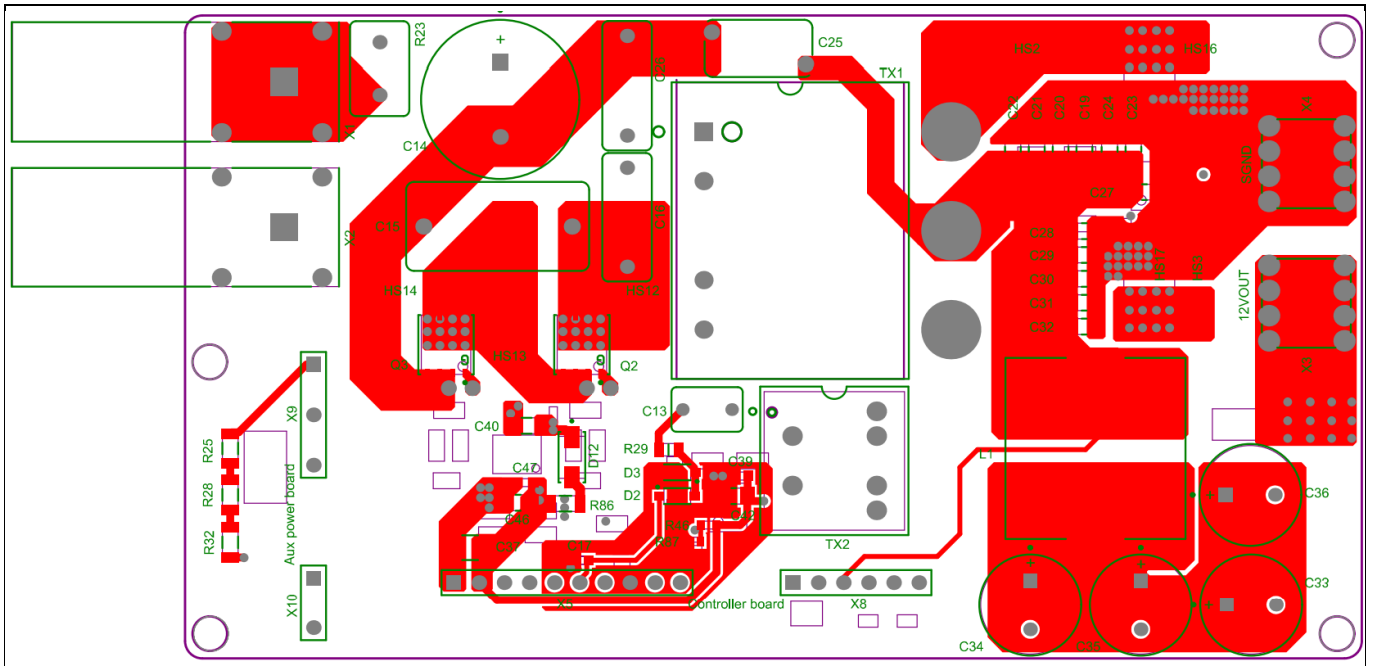

Figure 13 The first layer routing of the EVAL 2ED2101 HB-LLC

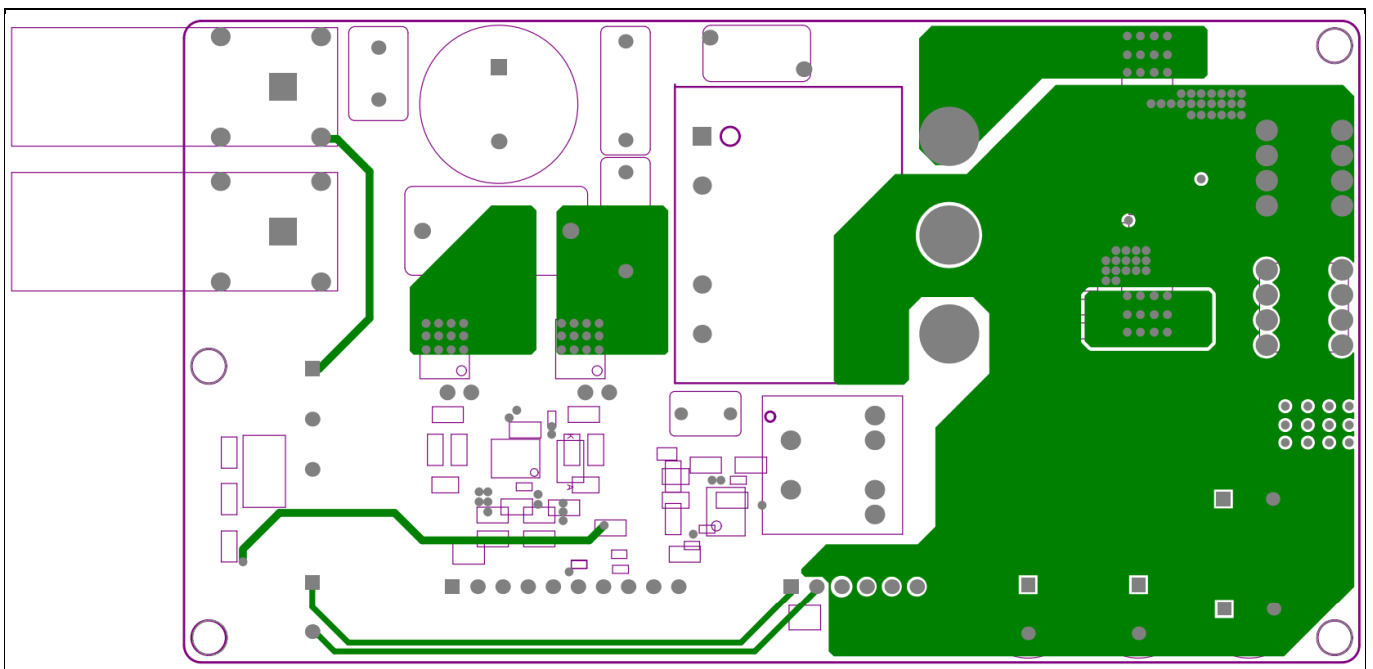

Figure 14 The second layer routing of the EVAL 2ED2101 HB-LLC

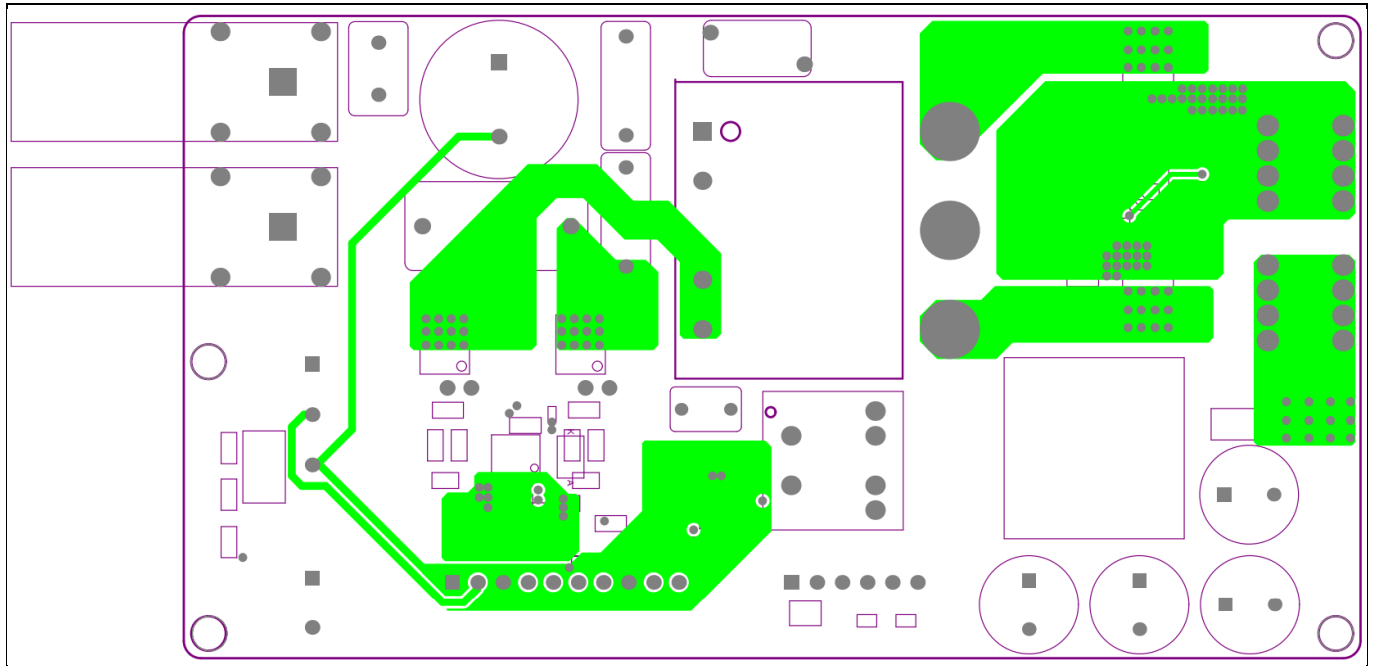

Figure 15 The third layer routing of the EVAL 2ED2101 HB-LLC

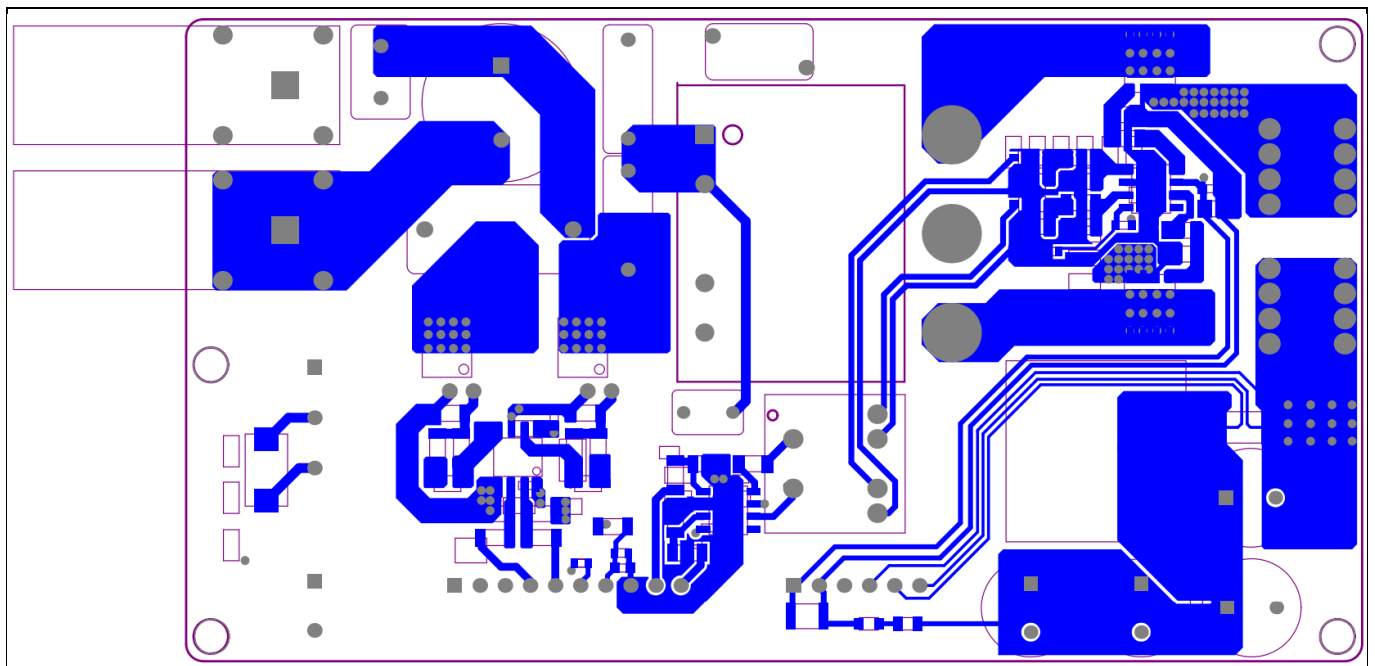

Figure 16 The fourth layer routing of the EVAL 2ED2101 HB-LLC

Fast switching 200 W LLC - Converter

2ED2101S06F & 2ED24427N01F in fast switching application



System design

3.3 Bill of material

The complete bill of material is available on the download section of the Infineon homepage. A log-in is required to download this material.

The bill of material is split into 3 separate parts for main boards, controller board and auxiliary supply board.

● BOM of the main board

Table 3 BOM of the main board

Quantity	Ref Designator	Value	Description	Manufacturer	Manufacturer P/N
1	C25	2.2nF	AC Line Rated Ceramic Disc Capacitor Class X1, 760 VAC / Class Y1, 500 VAC	Vishay	440LD22-R
4	C33, C34, C35, C36	1mF	Low ESR High Ripple Aluminium Solid Capacitor	AiSHi	SPD1CM102G12O00RAXXX
2	C37, C61	22uF	Chip Monolithic Ceramic Capacitor	MuRata	GRM32ER61E226KE15
4	C38, C39, C43, C47	100nF	SMD Auto X7R, Ceramic Capacitor	Kemet	C0603C104K5RACAUTO
1	C40	330nF	Chip Monolithic Ceramic Capacitor	MuRata	GRM319R71E334JA01
1	C45	1uF	Chip Monolithic Ceramic Capacitor	MuRata	GRM31MR71H105MA88
1	C63	100uF	Low ESR Surge Robust Tantalum Capacitor	Kemet	T495X107K020ATE150
4	D1, D2, D3, D4	MBR0540-TP	Schottky Rectifier, 0.5A/60V	Micro Commercial Components	MBR0540-TP
1	D5	Red	CHIP LED	Würth Elektronik	150080RS75000
4	D6, D7, D8, D9	1N4148W-13-F	Surface Mount Fast Switching Diode	Diodes Incorporated	1N4148W-13-F
1	D12	NC	Surface Mount Ultrafast Rectifier 1.0A/600V	ST	STTH1R06A
13	HS1, HS2, HS4, HS6, HS7, HS8, HS9, HS12, HS13, HS15,		PCB mounting, 5mm L X 5mm W X 1.5mm H	Taobao	Customized

Fast switching 200 W LLC - Converter

2ED2101S06F & 2ED24427N01F in fast switching application



System design

Quantity	Ref Designator	Value	Description	Manufacturer	Manufacturer P/N
	HS16, HS17, HS18				
6	HS3, HS5, HS10, HS11, HS14, HS19		PCB mounting, 5mm L X 2.5mm W X 1.5mm H	Taobao	Customized
1	L1	1.9uH	WE-HCI SMD Flat Wire High Current Inductor	Würth Elektronik	7443556190
2	Q1, Q4	BSC022N04LS6	OptiMOS Power- MOSFET	Infineon Technologies	BSC022N04LS6
2	Q2, Q3	IPL60R650P6S	600V CoolMOS P6 Power Transistor, RDS 0.65Ohm, ID 16.5A	Infineon Technologies	IPL60R650P6S
1	R23	5R	NTC thermistors for inrush current limiting	TDK Corporation	B57235S0509M000
2	R24, R38	1R	Standard Thick Film Chip Resistor	Vishay	CRCW12061R00FK
4	R25, R28, R32, R33	750k	Standard Thick Film Chip Resistor	Vishay	CRCW1206750KFK
2	R26, R40	1.2R	Standard Thick Film Chip Resistor	Vishay	CRCW12061R20FK
3	R27, R39, R86	10R	Standard Thick Film Chip Resistor	Vishay	CRCW120610R0FK
1	R29	220R	Standard Thick Film Chip Resistor	Vishay	CRCW0805220RFK
4	R30, R31, R41, R42	20k	Metal Film (Thin Film) Chip Resistor	Panasonic	ERA-8AEB203V
1	R34	51R	Standard Thick Film Chip Resistor	Vishay	CRCW060351R0FK
1	R35	1mR	0.001R/1%	Bourns	CSS2H-2512R-1L00F
1	R36	11k	Standard Thick Film Chip Resistor	Vishay	CRCW060311K0FK
1	R37	5.6k	Standard Thick Film Chip Resistor	Vishay	CRCW08055K60FK
2	R43, R52	3.9k	Standard Thick Film Chip Resistor	Vishay	CRCW12063K90FK
2	R45, R60	4.7k	Standard Thick Film Chip Resistor	Vishay	CRCW12064K70FK
2	R46, R48	10k	General Purpose Chip Resistor	Yageo	RC0603FR-0710KL

Fast switching 200 W LLC - Converter

2ED2101S06F & 2ED24427N01F in fast switching application



System design

Quantity	Ref Designator	Value	Description	Manufacturer	Manufacturer P/N
2	R47, R51	100R	Standard Thick Film Chip Resistor	Vishay	CRCW1206100RFK
2	R50, R54	6.8k	Standard Thick Film Chip Resistor	Vishay	CRCW12066K80FK
2	R55, R56	10k	Standard Thick Film Chip Resistor	Vishay	CRCW120610K0FK
2	R58, R59	2k	Standard Thick Film Chip Resistor	Vishay	CRCW12062K00FK
2	R87, R88	4.75k	Standard Thick Film Chip Resistor	Vishay	CRCW06034K75FK
1	TX1	See M. P.N.	Resonant transformer	Sunlord	ATWPPQ273230A300P-02
1	TX2	750344535-01	Pulse transformer	Würth Elektronik	750344535-01
1	U2	2ED2101S06F	high-side and low-side gate driver with integrated bootstrap diode	Infineon Technologies	2ED2106S06F
2	U3, U4	2ED24427N01F	Dual Low Side Driver	Infineon Technologies	2ED24427N01F
1	X1	23.3200-22	4 mm Angled Sockets 1000 V, CAT III / 24 A / Red	Multi-Contact	23.3200-22
1	X2	23.3200-21	4 mm Angled Sockets 1000 V, CAT III / 24 A / Black	Multi-Contact	23.3200-21
2	X3, X4	7460307	WP-BUTR Press-Fit with Internal thread, two rows, 9x9mm, 8 pins, M4x6mm, 160A	Würth Elektronik	7460307
1	X5		Header, 10-Pin		
1	X8		Header, 6-Pin		
1	X9		Header, 5-Pin		
1	X10		Header, 3-Pin		

● BOM of the controller board

Table 4 BOM of the controller board

Quantity	Ref Designator	Value	Description	Manufacturer	Manufacturer P/N
5	C1, C4, C7, C58, C62	1nF	Chip Monolithic Ceramic Capacitor	MuRata	GCM188R71E102KA37
1	C2	22nF	Chip Monolithic Ceramic Capacitor	MuRata	GRM188R71C223JA01

Fast switching 200 W LLC - Converter

2ED2101S06F & 2ED24427N01F in fast switching application



System design

Quantity	Ref Designator	Value	Description	Manufacturer	Manufacturer P/N
1	C3	10pF	Chip Monolithic Ceramic Capacitor	MuRata	GCM1885C1H100JA16
6	C5, C8, C44, C50, C59	100nF	Surface Mount Multilayer Ceramic Chip Capacitor	Kemet	C0603C104J3RAC
3	C6, C48, C60	10uF	Commerical Grade Multilayer Ceramic Chip Capacitor	TDK Corporation	C3216X7R1E106K160AB
1	C9	1uF	Chip Monolithic Ceramic Capacitor	MuRata	GRM188R61E105KA12
1	C10	3.3uF	Chip Monolithic Ceramic Capacitor	MuRata	GRM21BR61E335KA12
2	C11, C12	3.3nF	Chip Monolithic Ceramic Capacitor	MuRata	GRM188R71E332KA01
4	C49, C52, C55, C56	10nF	Chip Monolithic Ceramic Capacitor	MuRata	GRM188R71E103KA01, GCM188R71H103JA37
1	C51	NC	Surface Mount Multilayer Ceramic Chip Capacitor	Kemet	C0603C104J3RAC
1	C53	2.2nF	Chip Monolithic Ceramic Capacitor	MuRata	GRM188R71E222JA01
1	C54	100pF	Chip Monolithic Ceramic Capacitor	MuRata	GRM1885C1H101JA01
1	D10	5.10V	500mW Surface Mount Zener Diode	Diodes Incorporated	MMSZ5231B-7-F
1	D11	1N4148W-13-F	Surface Mount Fast Switching Diode	Diodes Incorporated	1N4148W-13-F
1	Q5	BSS138N	N-Channel Small Signal Transistor	Infineon Technologies	BSS138N
2	R1, R5	100R	Standard Thick Film Chip Resistor	Vishay	CRCW0603100RFK
1	R2	NC	General Purpose Chip Resistor	Yageo	RC0603FR-073K3L
3	R3, R11, R75	NC	Standard Thick Film Chip Resistor	Vishay	CRCW0603390KFK, CRCW060339K0FK, CRCW060313K0FK
1	R4	16k	Standard Thick Film Chip Resistor	Vishay	CRCW060316K0FK
1	R6	160k	Standard Thick Film Chip Resistor	Vishay	CRCW0603160KFK
1	R7	162k	Standard Thick Film Chip Resistor	Vishay	CRCW0603162KFK

Fast switching 200 W LLC - Converter

2ED2101S06F & 2ED24427N01F in fast switching application



System design

Quantity	Ref Designator	Value	Description	Manufacturer	Manufacturer P/N
1	R8	2R	Standard Thick Film Chip Resistor	Vishay	CRCW08052R00FK
2	R9, R83	3.6k	Automotive Grade Thick Film Chip Resistor	Yageo	AC0603FR-073K6L
1	R10	2R	2R/150V/5%	Panasonic	ERJ-PA3J2R0V
1	R12	27k	Standard Thick Film Chip Resistor	Vishay	CRCW060327K0FK
6	R13, R16, R19, R64, R73, R80	1MEG	Standard Thick Film Chip Resistor	Vishay	CRCW06031M10FK
1	R14	1.5k	Standard Thick Film Chip Resistor	Vishay	CRCW06031K50FK
1	R15	7.5k	Standard Thick Film Chip Resistor	Vishay	CRCW06037K50FK
1	R17	1k	1k/75V/1%	Panasonic	ERJ3EKF1001V
2	R18, R68	11k	Standard Thick Film Chip Resistor	Vishay	CRCW060311K0FK
2	R20, R69	2k	2k/75V/1%	Panasonic	ERJ3EKF2001V
1	R21	200R	Standard Thick Film Chip Resistor	Vishay	CRCW0603200RFK
1	R22	2MEG	Standard Thick Film Chip Resistor	Vishay	CRCW06032M00FK
1	R44	2k	Standard Thick Film Chip Resistor	Vishay	CRCW12062K00FK
3	R49, R53, R79	3.3k	General Purpose Chip Resistor	Yageo	RC0603FR-073K3L
1	R62	200k	Standard Thick Film Chip Resistor	Vishay	CRCW0603200KFK
1	R63	2.2k	Standard Thick Film Chip Resistor	Vishay	CRCW08052K20FK
1	R65	220k	Standard Thick Film Chip Resistor	Vishay	CRCW0603220KFK
1	R66, R78	47k	Standard Thick Film Chip Resistor	Vishay	CRCW060347K0FK
1	R67	750R	Standard Thick Film Chip Resistor	Vishay	CRCW0603750RFK
2	R70, R81	1k	1k/150V/1%	Vishay	CRCW08051K00FKEAHP
2	R71, R76	0R	General Purpose Chip Resistor	Yageo	RC0603JR-070RL
1	R72	1k	Standard Thick Film Chip Resistor	Vishay	CRCW12061K00FK

Fast switching 200 W LLC - Converter

2ED2101S06F & 2ED24427N01F in fast switching application



System design

Quantity	Ref Designator	Value	Description	Manufacturer	Manufacturer P/N
1	R74	13k	Standard Thick Film Chip Resistor	Vishay	CRCW060313K0FK
1	R77	22k	Standard Thick Film Chip Resistor	Vishay	CRCW060322K0FK
1	R82	10k	General Purpose Chip Resistor	Yageo	RC0805FR-0710KL
1	R84	20k	Standard Thick Film Chip Resistor	Vishay	CRCW060320K0FK
1	R85	4.75k	Standard Thick Film Chip Resistor	Vishay	CRCW06034K75FK
1	U1	ICE2HS01G	High Performance Resonant Mode Controller	Infineon Technologies	ICE2HS01G
2	U5, U7	TL431CDBZR	Precision Programmable Reference	Texas Instruments	TL431CDBZR
2	U6, U8	SFH617A-3X007T	Optocoupler, Phototransistor Output, High Reliability, 5300 VRMS, 110 Â°C Rated	Vishay	SFH617A-3X007T
1	U9	INA193AIDBVR	Current shunt monitor -16V to +80V common mode range	Texas Instruments	INA193AIDBVR
1	U10	LM2903D	Dual differential comparators	Texas Instruments	LM2903D
1	X6		Header, 6-Pin, Right Angle		
1	X7		Header, 10-Pin, Right Angle		

- **BOM of the auxiliary supply board**

Table 5 BOM of the auxiliary supply board

Quantity	Ref Designator	Value	Description	Manufacturer	Manufacturer P/N
1	C100	22nF	Capacitor Ceramic	MuRata	GRM32DR73A223KW01L
2	C101, C104	1uF	Chip Monolithic Ceramic Capacitor	MuRata	GRM31CR71H105KA61
2	C102, C103	220uF	Low ESR Surge Robust Tantalum Capacitor	Kemet	T495X107K020ATE150
1	C105	22uF	Chip Monolithic Ceramic Capacitor	MuRata	GRM32ER61E226KE15

Fast switching 200 W LLC - Converter

2ED2101S06F & 2ED24427N01F in fast switching application



System design

Quantity	Ref Designator	Value	Description	Manufacturer	Manufacturer P/N
1	C106	100nF	Chip Monolithic Ceramic Capacitor	MuRata	GRM21BR71E104MA01
1	C107	10pF	Chip Monolithic Ceramic Capacitor	MuRata	GRM31A5C3A100JW01
1	C108	180pF	Chip Monolithic Ceramic Capacitor	MuRata	GCM2165C1H181GA16
1	C109	1nF	Chip Monolithic Ceramic Capacitor	MuRata	GRM216R71E102JA01
1	C110	1.5nF	Chip Monolithic Ceramic Capacitor	MuRata	GCM216R71H152KA37
1	C111	100uF	Low ESR Surge Robust Tantalum Capacitor	Kemet	T495X107K020ATE150
2	D100, D102	MBRS1100T3G	Schottky Power Rectifier	ON Semiconductor	MBRS1100T3G
1	D101	15.30V	Voltage regulator diode	Nexperia	BZX384-B15,115
2	D103, D104	BAT165	Medium Power AF Schottky Diode	Infineon Technologies	BAT165
1	D105	2.4V	Voltage regulator diode	Nexperia	BZX384-B2V4,115
1	D106	12V	Voltage regulator diode	Nexperia	BZX384-B12,115
1	D107	Red	CHIP LED	Wurth Elektronik	150080RS75000
1	Q100	BSS138N	N-Channel Small Signal Transistor	Infineon Technologies	BSS138N
1	Q101	IPN95R3K7P7	CoolMOS CE Power Transistor, VDS 950V	Infineon Technologies	IPN95R3K7P7
1	R100	33R	Standard Thick Film Chip Resistor	Vishay	CRCW080533R0FK
1	R101	2.2k	Standard Thick Film Chip Resistor	Vishay	CRCW08052K20FK
1	R102	24k	Standard Thick Film Chip Resistor	Vishay	CRCW080524K0FK
3	R103, R105, R107	3.3MEG	Standard Thick Film Chip Resistor	Vishay	CRCW08053M30FK
3	R104, R106, R108	10MEG	Standard Thick Film Chip Resistor	Vishay	CRCW080510M0FK
1	R109	22R	Standard Thick Film Chip Resistor	Vishay	CRCW080522R0FK
1	R110	3.3R	Standard Thick Film Chip Resistor	Vishay	CRCW08053R30FK

Fast switching 200 W LLC - Converter

2ED2101S06F & 2ED24427N01F in fast switching application



System design

Quantity	Ref Designator	Value	Description	Manufacturer	Manufacturer P/N
1	R111	150k	Standard Thick Film Chip Resistor	Vishay	CRCW0805150KFK
1	R112	47R	Standard Thick Film Chip Resistor	Vishay	CRCW080547R0FK
1	R113	1k	1k/150V/1%	Vishay	CRCW08051K00FKEAHP
1	R114	10k	General Purpose Chip Resistor	Yageo	RC0805FR-0710KL
1	TX100	750344693-00	Flyback transformer	Würth Elektronik Midcom	750344693-00
1	U100	ICE5QSBG	Quasi-Resonant PWM Controller	Infineon Technologies	ICE5QSBG
1	X100	TSW-203-08-L-S-RA	Pin Header 5 pole		
1	X101	TSW-202-08-L-S-RA	Pin Header 3 contacts		

System performance

4 System performance

4.1 Power-up and test procedure

4.1.1 Test points and measurement conditions

The EVAL 2ED2101 HB-LLC features several measurements points, as can be seen in Figure 17. In order to use these properly, creating ground loops with the oscilloscope probes between primary and secondary side of the evaluation boards should be avoided.

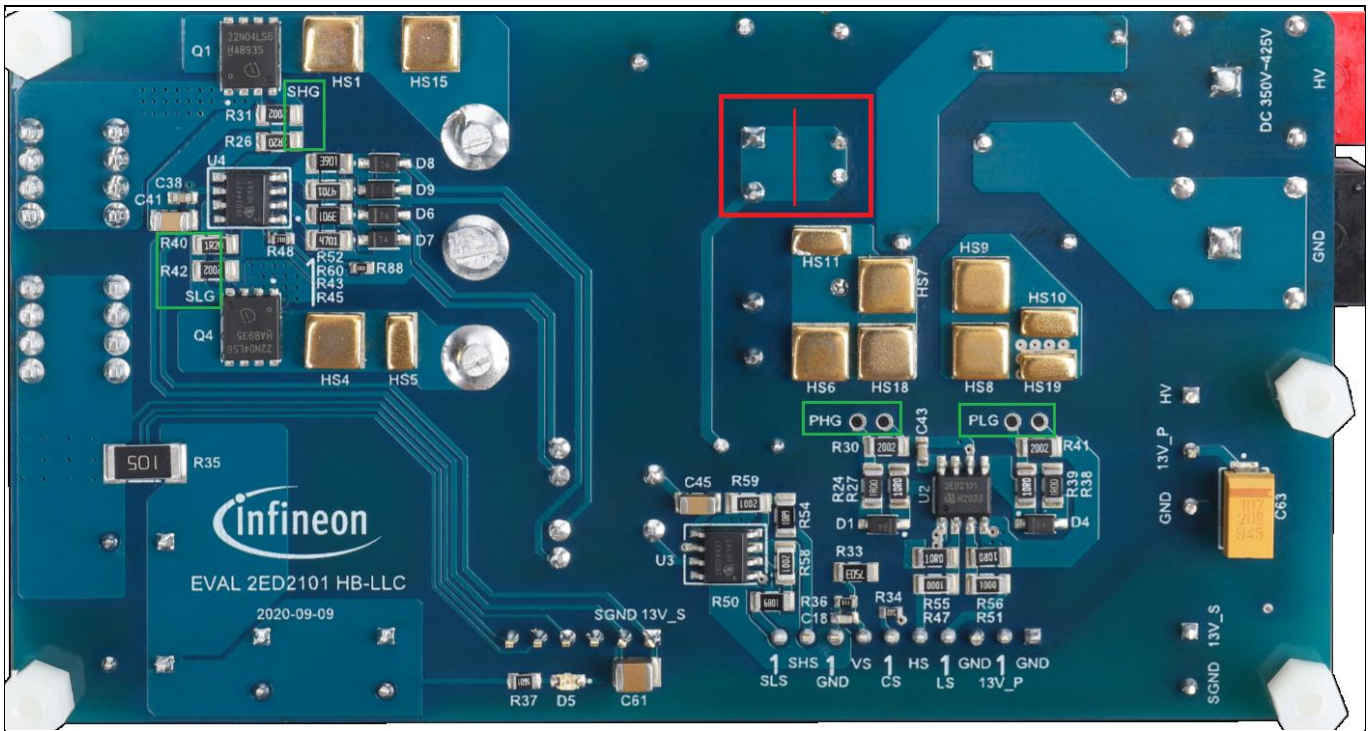

Figure 17 Test points for key parameters at EVAL 2ED2101 HB-LLC: Resonant tank current I_r (polygons need to be cut), PHG, PLG, SHG and SLG

In addition, the gate voltage of the primary-side, half-bridge switch driven by 2ED2101S06F is level shifted to high-voltage domains. This means an isolated probe needs to be used to measure the signal PHG.

To measure to resonant tank current I_r , the polygon above HS11 (see red box in Figure 17 oben) needs to be cut and a wire loop soldered between the two cut areas.

4.1.2 Test procedure

After all power connections are installed properly and all measurement points are set up, the EVAL 2ED2101 HB-LLC evaluation board can be started. The conditions for start-up and some reference points for performance evaluation can be found in Table 6 unterhalb.

There are several signals which need to be measured at the board as described in Figure 17 oben. The switching frequency of the primary-side power stage, $f_{sw_{PRIM}}$, is measured at the low-side gate of the 2ED2101 halfbridge gate driver, PLG. The switching frequency of the synchronous rectification stage $f_{sw_{SR}}$ is measured at the low-side gate of the 2ED24427 synchronous rectifier gate driver, SLG.

Fast switching 200 W LLC - Converter

2ED2101S06F & 2ED24427N01F in fast switching application



System performance

Table 6 Power-up and test procedure

Test	Test procedure	Condition	
1. Auxiliary circuit turn-on	Apply 360 V _{DC} on the input	Vin: ~360 V _{DC}	
		Red LED will light up at auxiliary supply	
2. LLC converter turn-on	Apply 372 V _{DC} , converter will give V _{out} = 12 Vdc	Vin: 372 V _{DC}	
		V _{out} : 12 V	
3. Operational switching frequency	Using voltage probe, monitor switching frequency at following test conditions:	Vin: variable	
		V _{out} : 12 V	
		100% output load: minimum f _{sw_{PRIM}} ~ 347 kHz*, f _{sw_{SR}} ~ 345 kHz*	Vin: 350 V _{DC} I _{out} : 16.7 A
		50% output load: normal f _{sw_{PRIM}} ~ 397 kHz*, f _{sw_{SR}} ~ 380 kHz*	Vin: 380 V _{DC} I _{out} : 8.3 A
		Below 10% output load: maximum f _{sw_{PRIM}} ~ 495 kHz*, f _{sw_{SR}} ~ 416 kHz*	Vin: 425 V _{DC} I _{out} : 1 A
	[* +/-10 kHz]		
4. Hold-up time	Use converter with 380 V in steady-state operation, then disconnect Vin, measure how long it takes until converter turns off	Vin = 380 V _{DC}	
	f _{sw_{PRIM}} = 335 kHz	I _{out} = 16.7 A	
		T _{hold} = 5.5 ms	
5. Start-up at No load	Switch at 380 V _{DC} on, no load output	Vin = 380 V _{DC}	
		I _{out} = 0 A	
	Operation should be in burst mode f _{sw_{prim}} = 686 kHz	V _{out} = 11.5 – 12.5 V _{DC}	
		t _{burst} = 67 μs t _{start} = 10 ms	
6. Start-up at full load	Apply 380 V _{DC} to input and connect full output load of 16.7 A	Vin = 380 V _{DC} I _{out} = 16.7 A	
	Results: V _{out} deviation between 11.8 – 12.2 V _{DC} * (*measured on the board connector) Start up time for LLC converter 10.8 ms f _{sw_{prim}} = 650 kHz	V _{out} = 11.8 – 12.3 V _{DC} t _{start} = 10.8 ms	
7. Running full load -> over current protection	Apply 380 V _{DC} , 16.7 A with full load output current. Increase the current on the output 1 A each step until the converter goes into protection starting from 16 A. OCP occurs between 18.5 A and 19.5 A.	Vin = 380 V _{DC} I _{out} = 16.7 A	
		OCP = between 18.5 A and 19.5 A	
8. Running full load -> output short circuit	Apply 380 V _{DC} 16.7 A with full load output current, short circuit the load using the short circuit functions of the load. Converter should latch and start in hiccup mode.	Vin = 380 V _{DC} I _{out} = 16.7 A	
		I _{out_{SC}} = short circuit	
		t _{Latch} = 450 μs	

Fast switching 200 W LLC - Converter

2ED2101S06F & 2ED24427N01F in fast switching application



System performance

Table 6 Power-up and test procedure		
Test	Test procedure	Condition
		$I_{out_hiccup} = 25.5 \text{ A}$
9. Start- up -> output short circuit	Switch off the input	$V_{in} = 0 \text{ V}_{DC}, I_{out} = 0 \text{ A}$
	Apply 380Vdc with output load short circuit, converter should be in hiccup mode	$I_{out_hiccup} = 25.5 \text{ A}$
	Remove short circuit function on the load	$V_{in} = 380 \text{ V}_{DC}$
10. Dynamic loading	Apply 380 V _{DC} . Set the electronic load to dynamic in CC loading mode with the following settings:	$V_{in} = 380 \text{ V}_{DC}$
	Repetitive pulse, 50% duty cycle	
	Switching frequency between 500 Hz and 5 kHz	
	Low level: $I_{out} 1.5 \text{ A}$	
	High level: $I_{out} 16.7 \text{ A}$	
	Maximum load slew rate: 1 A/μS	
	Results: maximum V _{out} deviation @500 Hz	$V_{out} = 11.3 - 12.44 \text{ V}_{DC}$

Fast switching 200 W LLC - Converter

2ED2101S06F & 2ED24427N01F in fast switching application

System performance

4.2 Board operation

4.2.1 ZVS behavior analysis

The ZVS behavior analysis checks the most important operation points within steady-state operation.

Figure 18 shows the primary-side signals for controlling the resonant tank. The golden line represents the voltage at the low-side gate, VLG, of the HV 600 V CoolMOS™ P6 MOSFET; the green line is the gate voltage of the high-side switch VH; the red line is the resonant tank current I_r ; and the blue line is the voltage over the low side switch VLDS.

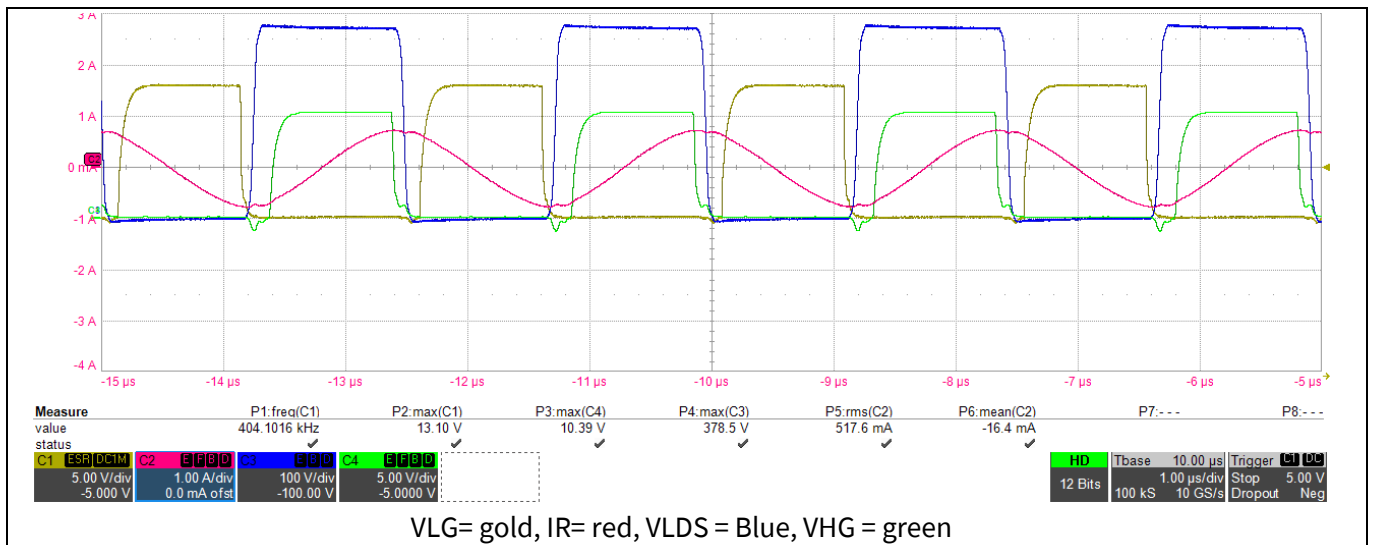

Figure 18 EVAL 2ED2101 HB-LLC: Steady state behavior at 370 V input and 1 A load

Even in light load condition of only 1 A load current, the average current of the resonant tank is only slightly below zero with a drift of less than 3%. In full load condition with 16.7 A load current, as shown in Figure 19, the current drift is far less the 1%.

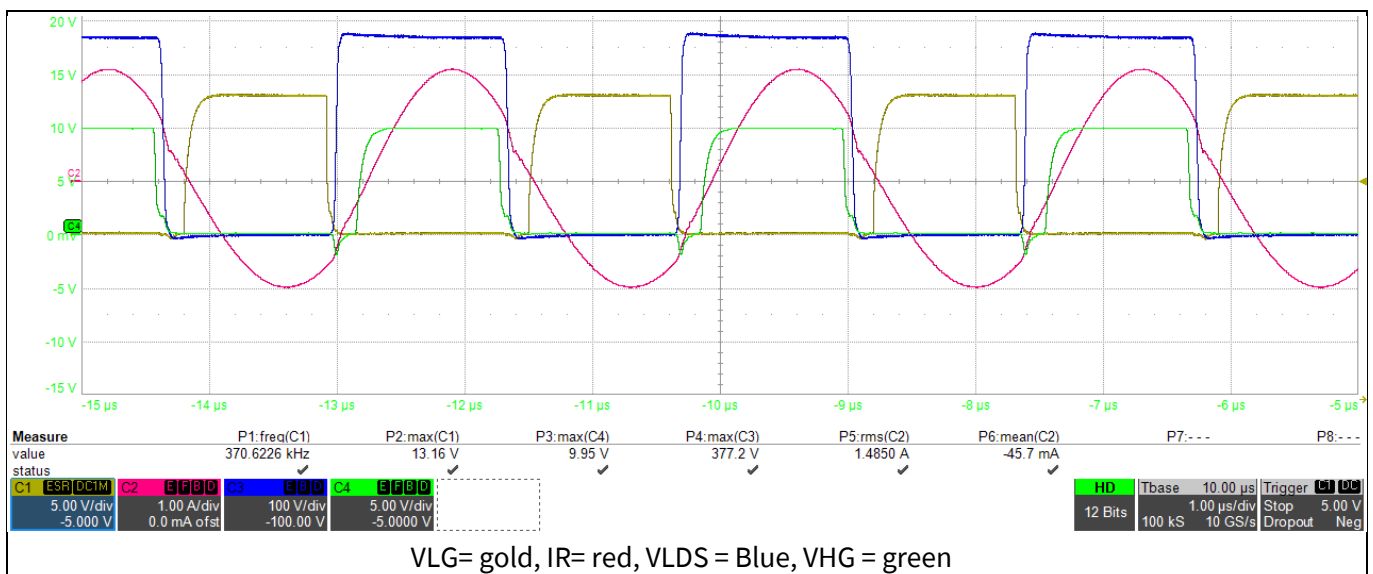

Figure 19 EVAL 2ED2101 HB-LLC: Steady state behavior at 370 V input and 16.7 A load

Fast switching 200 W LLC - Converter

2ED2101S06F & 2ED24427N01F in fast switching application

System performance

The bootstrap network, consisting of the integrated bootstrap diode and the external bootstrap capacitor, is dimensioned to switch the high side gate with a voltage of 10 V. Thanks to the low dynamic resistance of the integrated bootstrap diode in 2ED2101S, using the internal bootstrap power supply structure, the VBS voltage remains higher than undervoltage lock-out level, even in high demanding operating points like soft start-up, where the working frequency of 2ED2101S reaches above 500 kHz.

In inductive load circuits using a half-bridge configuration, like LLC circuits, negative VS voltage is a well-known side effect of fast switching transitions in combination with circuit parasitics through layout and design. If an unwanted spike carries too much energy, the pulse can stress internal structures of the gate driver and lead in the worst case to a signal flip or a latch-up of the level-shift gate driver. Nevertheless, the 2ED2101S06F high-side and low-side gate driver in silicon-on-insulator technology shows best-in-class negative robustness against this parasitic spike, and can even survive repetitive spike events of more than 100 V for several hundred nanoseconds.

4.2.2 Burst mode operation

At no load or a very light load condition, the switching frequency regulation of the controller reaches its maximum setting. High switching frequency results in higher switching loss and magnetized core loss, caused by magnetizing current limitation and increased turn-off losses. In order to increase efficiency and minimize operation time in high switching frequency regulation, burst mode function is enabled and implemented in no load and light load operation (see Figure 20).

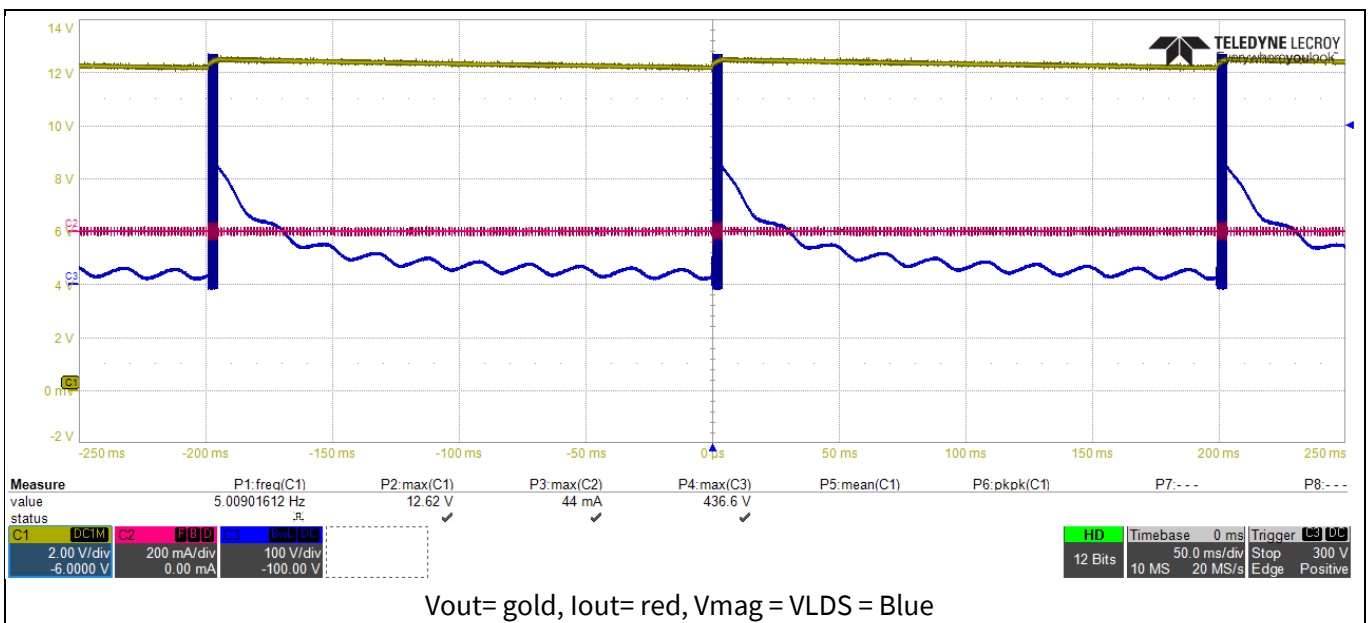

Figure 20 EVAL 2ED2101 HB-LLC: bursts at 425 V operation with no load

The burst mode is executed as soon as the load current is increased. Once the sensed output current increases over a user-designed threshold, the controller leaves the burst mode and goes into normal operation. [5]

In burst mode, the low-side switch is turned on periodically for a defined number of cycles so that enough charge can be created in the bootstrap network to safely drive the half-bridge switches. When the charge stored on the bootstrap capacitor is sufficient to supply the gate driver, it starts operating the half bridge with reduced switching frequency. This can be seen in Figure 21.

System performance

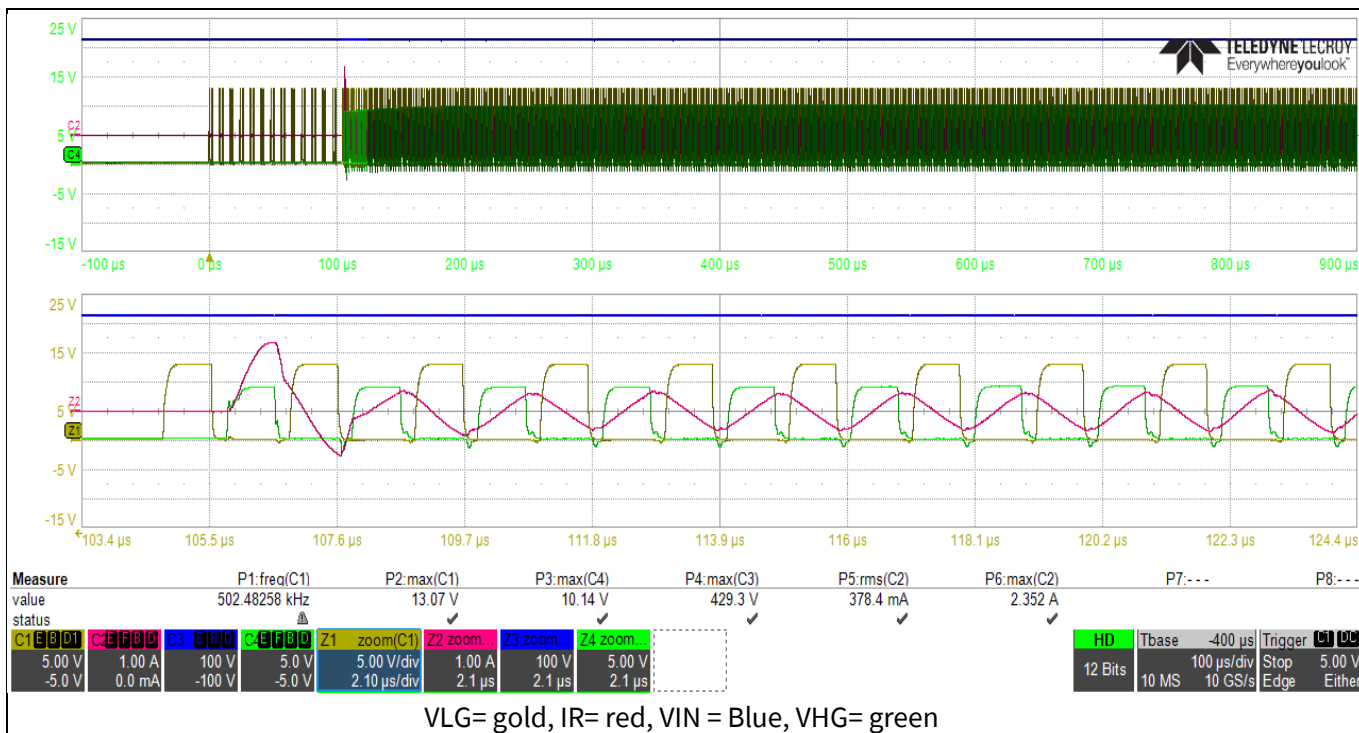

Figure 21 Burst mode zoomed at 425 V, no load: peak current of 2.35 A

The light load and no load regulation problems are affected mostly by the parasitic components like the primary to secondary main transformer coupling capacitance and the SR MOSFET output capacitance, which need to be charged properly for circuit operation.

The combination of these factors generates the so-called third resonant frequency in the LLC gain curve, which makes the converter difficult to control at no load. The burst mode helps to overcome this problem by limiting the unwanted primary to secondary power transfer, due to the above-mentioned parasitic effects. For further details about this burst-mode operation of the LLC converter, please refer to the specific literature [6].

4.2.3 LLC operation – soft and hard commutation

In the LLC converter, hard commutation of the body diode might occur during the start-up, burst mode, overload and short circuit condition. By good transformer design and adapted gate driving control measures the EVAL 2ED2101 HB-LLC board avoids going into hard commutation over the whole operation range.

Hard commutation occurs in LLC during the commutation period of the body diode. During this time, resonant inductor current flows through the body diode of the MOSFET, creating a ZVS condition on this MOSFET's turn-on. When the current is not able to change its direction prior to the turn-on of the complementary MOSFET, more charges will be stored in the P-N junction of that MOSFET. When the complementary MOSFET turns on, a large shoot-through current will flow due to reverse-recovery current of the body diode. This results in high reverse recovery peak current I_{RRM} and high reverse recovery dV/dT , which can lead to MOSFET breakdown in the worst case.

The occurrence of this condition can be prevented in the design by choice of the right control technique, a correct selection of resonant components and a proper setting of the minimum and maximum operating frequency.

System performance

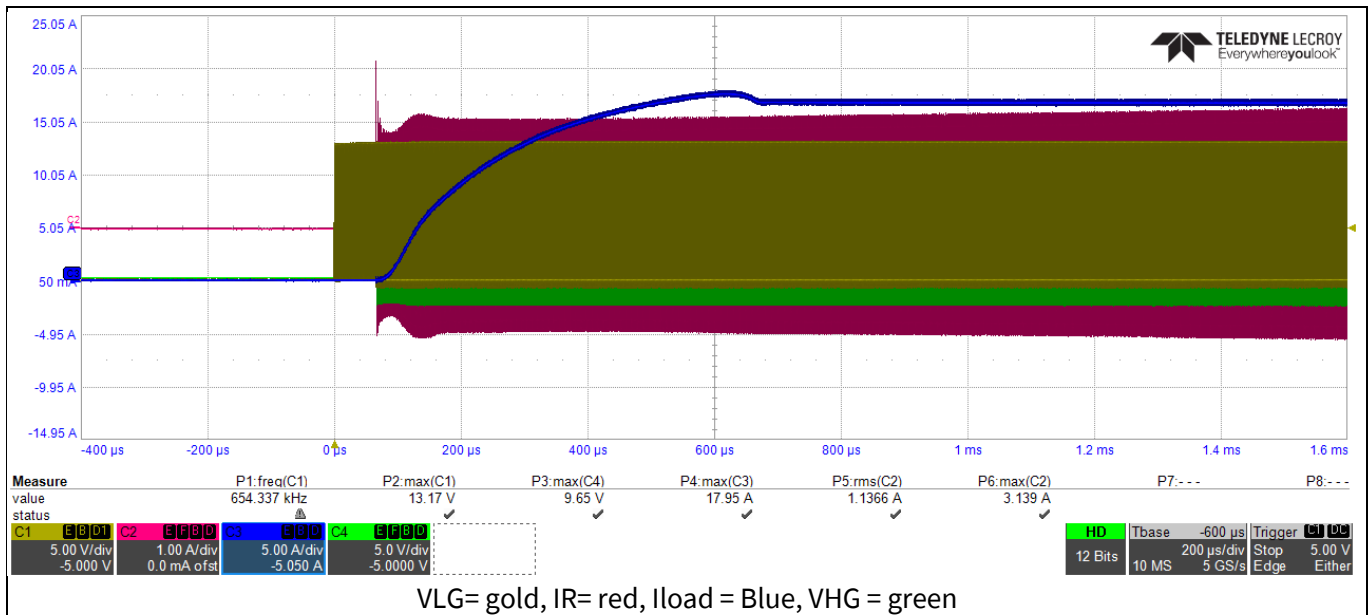

Figure 22 EVAL 2ED2101 HB-LLC: Start up with full load at 425 V as worst case for soft commutation

Figure 22 shows a typical application state where hard commutation could occur. As seen even in critical conditions, the EVAL 2ED2101 HB-LLC does not show any hard commutation. This is prevented by proper DV/DT control through gate driver resistor dimensioning and the design of the power transformer. The maximum current spike has an amplitude of 3.14 A and does not expose any danger of destruction to the 600 V high power MOSFETs of the resonant tank. After a few switching cycles, the system enters into steady state of burst mode control.

4.2.4 Synchronous rectification

Synchronous rectification (SR) in a half-bridge LLC resonant converter is important to achieve high efficiency. The control of SR provided by the ICE2HS01G includes four main parts: on-time control, turn-on delay, turn-off delay and protections.

A very important characteristic of the SR MOSFETs is very low on-resistance $R_{DS(on)}$. For high-power converters with low-output voltages on the secondary side of transformer, like the EVAL 2ED2101 HB-LLC, large currents flow through the SR MOSFETs. [6]

According to the power loss computation below for each SR MOSFET the conduction losses P_{cond} can only be mitigated by switches with minimal $R_{DS(on)}$.

$$P_{cond_SR} = R_{DS, on} \cdot (I_{RMS})^2$$

Besides low $R_{DS(on)}$ the chosen BSC022N04LS6 OptiMOS™ MOSFET is also optimized for low gate charges Q_g . This is important, since at light load or high switching frequency, the switching losses of the SR MOSFETs predominate over the conduction losses. In the case of LLC topology, the main contributor of these switching losses is in fact Q_g which will increase especially for high switching frequencies. Therefore, the Infineon OptiMOS™ 40 V generation is best suited for the synchronous rectifier stage because of the minimized gate charges and low parasitic inductances and excellent thermal behavior of the package.

Another important point is the synchronous switching of the MOSFETs in the SR stage. Due to the use of the 2ED24427N01F as SR driver an excellent channel matching is achieved. Together with the very narrow $V_{GS(th)}$ deviation range of the BSC022N04LS6 best switching performance can be observed.

System performance

4.3 Measurements and efficiency

This chapter contains more detailed performance analysis of the EVAL 2ED2101 HB-LLC. First some main contributors to loss and performance are discussed. Then temperature measurements are analyzed to show the efficient performance in high switching regulation. In addition, the overall efficiency of the evaluation board is discussed.

In the power stage of the LLC converter, the main contributor to the losses are the switching losses of the power MOSFETs, the gate driver losses and the losses of the main transformer. Many approaches to compute these losses can be found in the literature [7].

Many of the research papers neglect the fact that especially at light load with high switching frequency, the gate driver losses are a bottleneck in the design. Caused by the frequency dependent losses in the bootstrap network, and for level-shifting operation, the gate driver will heat up more than the power MOSFETs, which have reduced conduction losses at light load. The 2ED2101S06F is optimized exactly for operation at high switching frequency. The silicon-on-insulator technology minimizes IC internal parasitic structures, and shows therefore outstanding minimal level-shifting losses [2]. Even using the internal bootstrap network, which integrates the bootstrapping losses within the IC, the 2ED2101S06F shows far less heating than most level-shift ICs based on junction isolation technology. The integrated fast switching real bootstrap diode with lowest-in-class bootstrap resistance can be used over the whole switching frequency range of up to 600 kHz at burst mode.

In high switching operation, more and more losses are caused by parasitic elements of the PCB layout or in the transformer for example. These losses cannot be covered by theoretical analysis. The losses are best expressed by the heat they cause in operation in the respective components. Because of that, the design is evaluated in specific working points for the key components with temperature measurements.

In the synchronous rectification stage, the losses are mostly defined by conduction losses and switching losses in the MOSFET and gate driver. Switching losses are the main loss of MOSFET in high load, while conduction loss is the main loss of MOSFET in regular control mode. In addition to those losses, magnetizing losses of the transformer also have to be taken into account. A detailed analysis for this can be found in various application notes, which will guide the user in optimizing the synchronous rectifier stage according to his or her application needs [6].

4.3.1 Temperature measurements

Figure 23 shows the temperature measurement of the primary-side power stage around the 2ED2101S06F high-side and low-side gate driver.

As it is clearly visible in light load and high switching frequency operation, the losses of the 2ED2101S06F are the dominant losses in the power stage. The losses in the driver can be separated into three main contributors: level-shift loss, gate-output loss and bootstrap-diode loss.

For 350 V_{DC} input voltage (Figure 23 a)), the resonant frequency is too low to enter burst mode, even at light load conditions. In comparison to Figure 23 c), where burst mode is used, it can be seen that skipping switching cycles will reduce the losses of the gate driver. In this condition especially the bootstrap conduction losses are high, since the supply current needs to be high in order to charge the bootstrap capacitor within a very short on-time. [8] Besides that, level-shift losses are highest in high switching operation.

For higher load currents, the conduction losses of the HV MOSFETs, which can be seen below in red close to their cooling bodies, lead to stronger warming of the switches than the gate driver.

Nevertheless, also the gate driver shows strong self-heating which is caused first by level shifting losses, and second by internal conduction losses due to charging and discharging operations of the MOSFET gates.

System performance

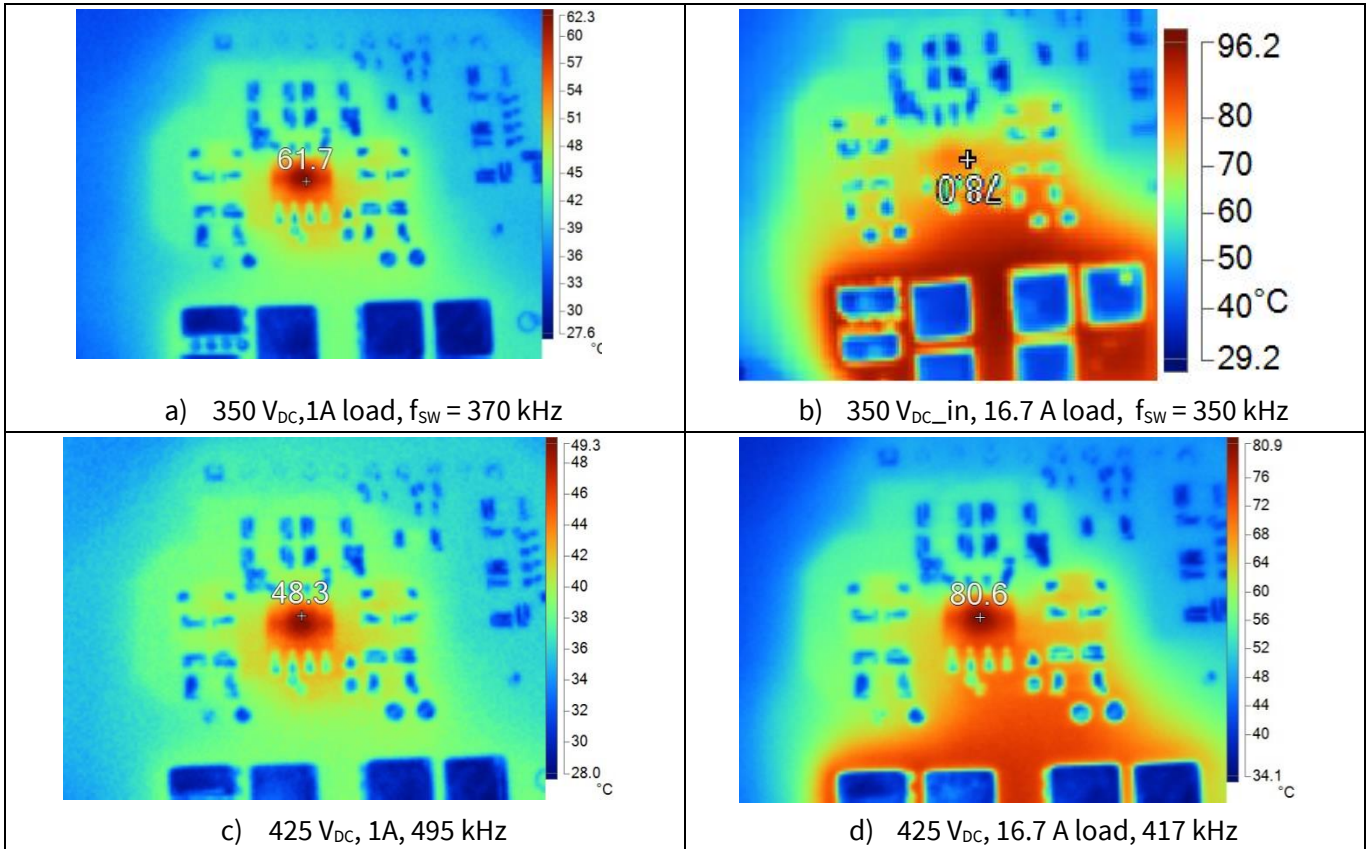

Figure 23 Temperature measurements around 2ED2101S06F – bottom side

The transformer losses are highest (80°C self-heating) in an operation point with relatively slow switching and high load current. Here besides magnetizing losses also copper losses are existing. For higher switching frequency and lower load currents the temperature of self-heating goes down about 10°C.

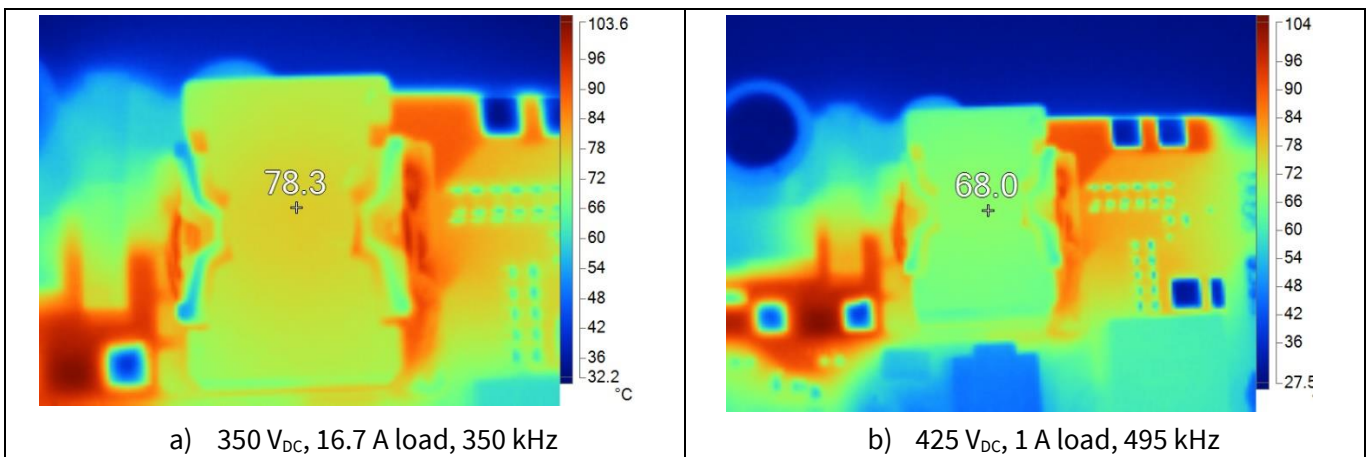

Figure 24 Temperature measurements of transformer – top side

With a self-heating temperature of maximum 80°C, the transformer proves good thermal performance with compact core size. [9]

System performance

The temperature measurements of the SR are shown in Figure 25. For light load condition the 2ED24427N01F shows excellent performance even at fast switching operation. The self-heating of approximately 40°C is only 15°C warmer than ambient temperature.

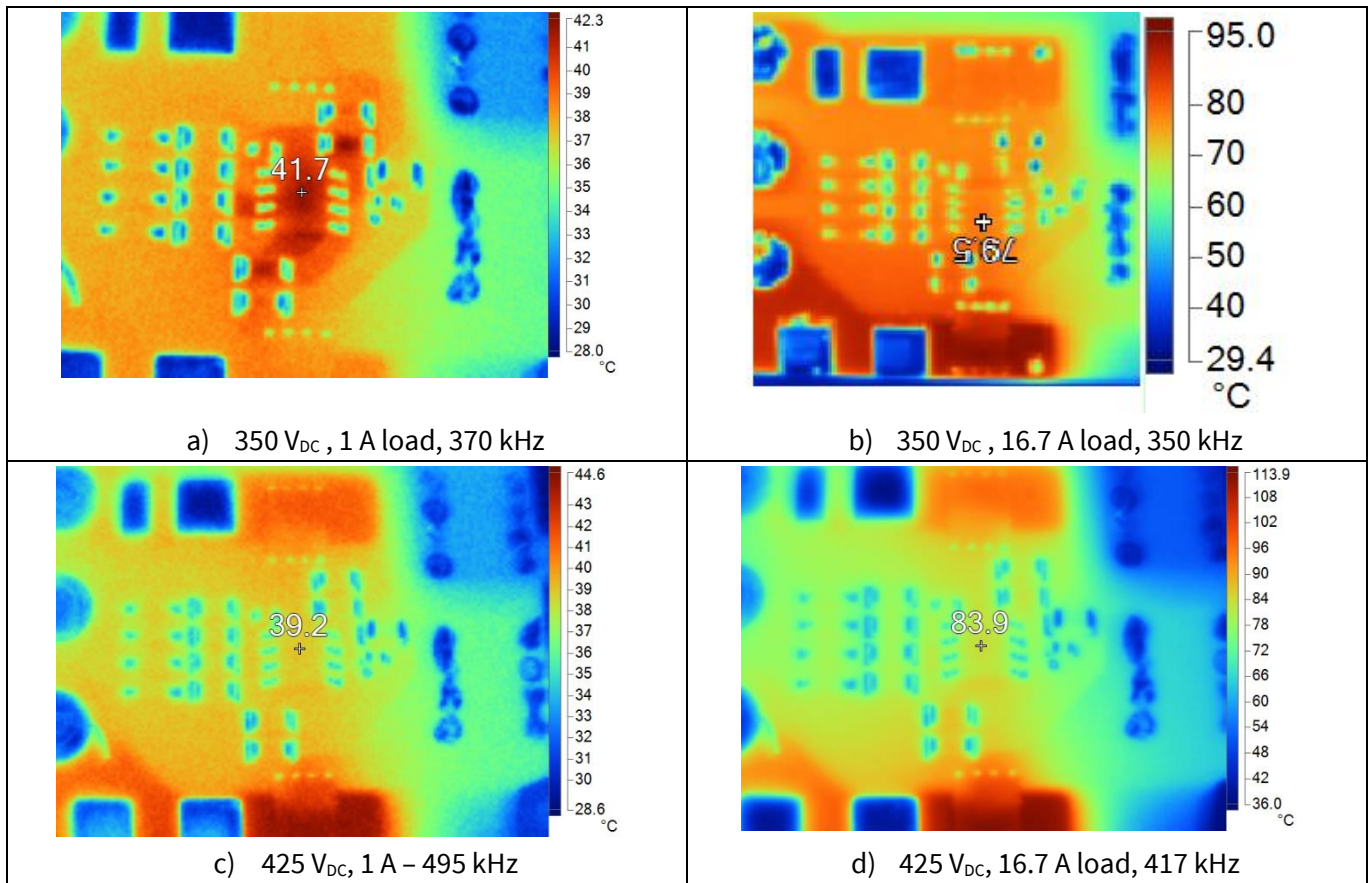

Figure 25 Temperature measurements of SR output stage - 2ED24427N01F - bottom side

The maximum losses can be seen in high load and high switching condition in Figure 25 d). Besides its own losses, such as switching and conduction losses, the gate driver will be also heated by the two warm switches in its close surroundings. The conduction losses of the SR OptiMOS™ MOSFETs are at maximum. The temperature of 84°C is high, but within acceptable range for the 2ED24427N01F.

4.3.2 Overall efficiency

Figure 26 shows the overall efficiency of EVAL 2ED2101 HB-LLC including the synchronous rectification stage for different input voltages between 350 V and 425 V.

System performance

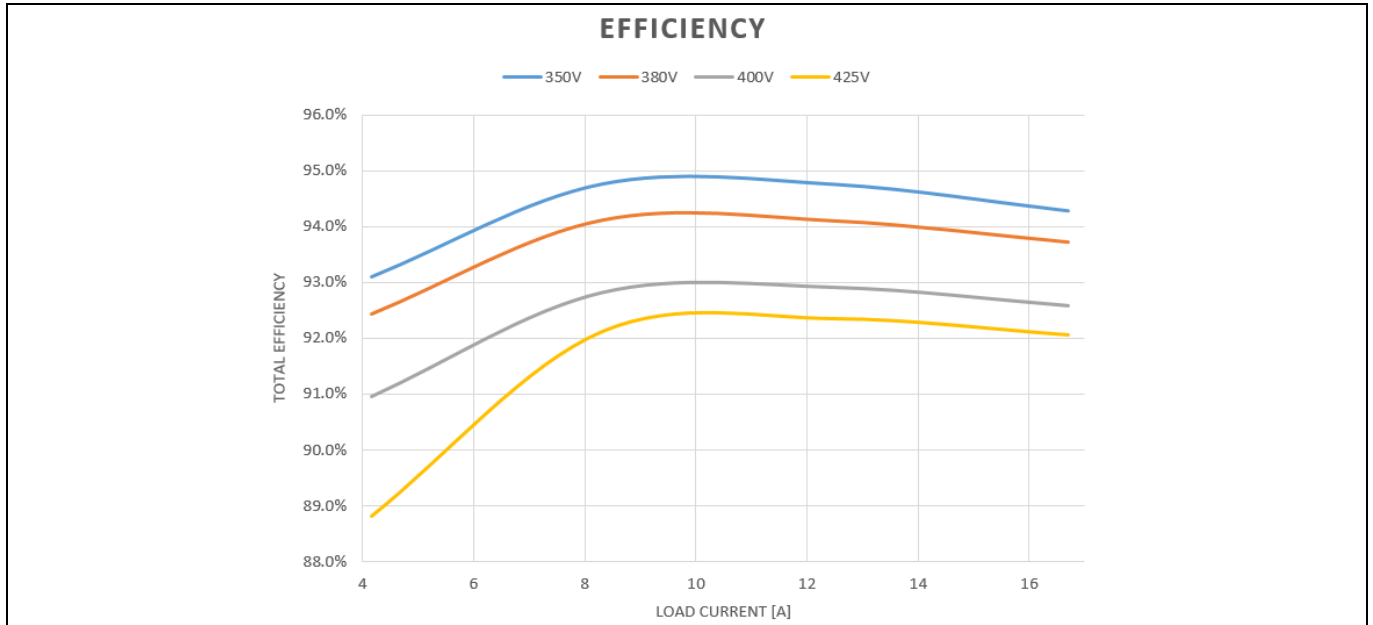

Figure 26 Efficiency of EVAL 2ED2101 HB-LLC including synchronous rectification stage

Table 7 Total efficiency of EVAL 2ED2101 HB-LLC

Current A	350 V	380 V	400 V	425 V
4.16	93.109%	92.425%	90.960%	88.822%
8.3	94.763%	94.113%	92.813%	92.114%
12.5	94.758%	94.102%	92.908%	92.349%
16.7	94.286%	93.720%	92.581%	92.060%

The efficiency of the EVAL 2ED2101 HB-LLC reaches up to 95% and shows good performance considering the fact that no external cooling is necessary for high-speed switching performance. As expected, the overall efficiency is lower than other low-speed switching LLC converters might show. This is mainly caused by increased switching losses in many components, discrete losses and parasitic structures on the board, and can also be found as a generic phenomena in the literature [9].

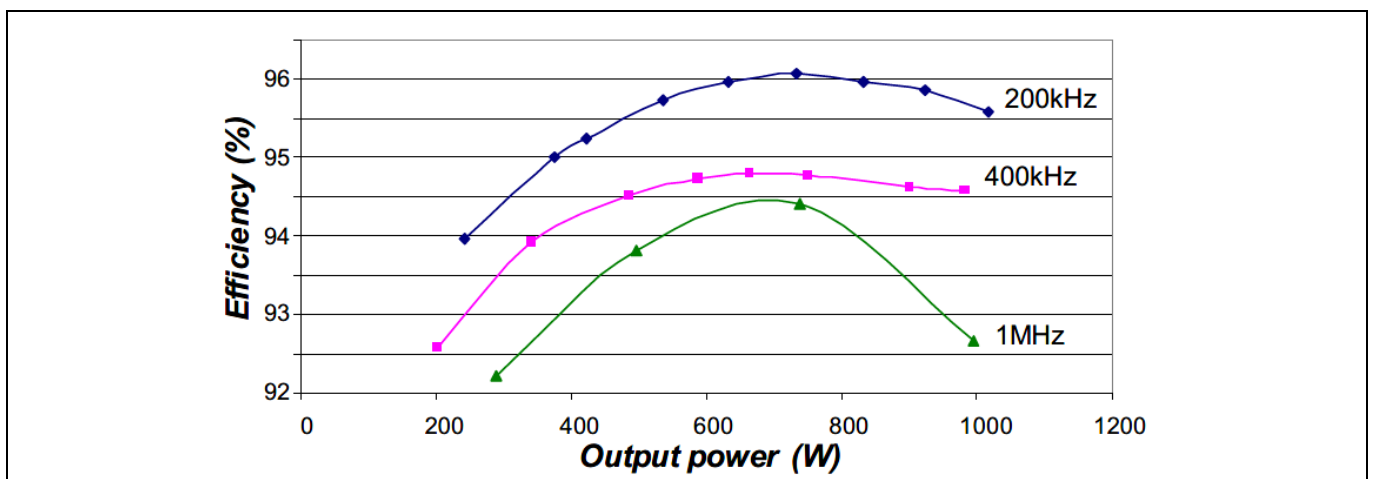

Figure 27 Efficiency of high switching frequency HB-LLC [9]

Fast switching 200 W LLC - Converter

2ED2101S06F & 2ED24427N01F in fast switching application



System performance

For the user, high switching frequencies are still a promising field for study. As mentioned in Chapter 1.1, the main benefits include:

- No external cooling is needed
- Potential for shrinking passive components such as transformer size and filters
- Better EMI performance (not covered in this user guide)
- Reduction of overall system size and BOM cost

This means that at the system level, high-speed switching allows for area and cost savings and performance improvements, such as EMI reduction. Depending on the application requirements, a trade-off between system savings and inverter performance needs to be found by the user.

5 References and appendices

5.1 Abbreviations and definitions

Table 8 Abbreviations

Abbreviation	Meaning
BOM	Bill of Material
CE	Conformité Européenne
EMI	Electromagnetic interference
IC	Integrated Circuit
SOI	Silicon on Insulator
SR	Synchronous Rectification
UL	Underwriters Laboratories
ZVS	Zero Voltage Switching

5.2 References

- [1] Infineon Technology AG, Application Matrix for Gate Driver ICs, [Every switch needs a driver - Gate driver application matrix \(infineon.com\)](#)
- [2] Infineon Technology AG, “Advantages of Infineon's high-voltage gate driver ICs (HVICs) based on its silicon-on-insulator (SOI) technology,” Application Note AN2019-12, V2.0, 2019-09-25, [Advantages of Infineon’s Silicon on Insulator \(SOI\) technology based High Voltage Gate Driver ICs](#)
- [3] Infineon Technology AG, “Gate resistor for power devices,” Application Note AN2015-06, V1.0, 2015-12-17, [EiceDRIVER™ - Gate resistor for power devices \(infineon.com\)](#)
- [4] Infineon Technology AG, “600 W half bridge LLC eval board with 600 V CoolMOS™ C7 and digital control by XMC™,” Application Note, V1.0, 2016-04-21, [600 W half bridge LLC eval board with 600 V CoolMOS™ C7 and digital control by XMC™](#)
- [5] Infineon Technology AG, “Design Guide for LLC Converter with ICE2HS01G,” Application Note AN-PS0057, V2.0, 2011-07-06, [Design Guide for LLC Converter with ICE2HS01G 05072011 \(infineon.com\)](#)
- [6] Infineon Technology AG, “Simple Design Techniques for Optimizing Efficiency and Overvoltage Spike of Synchronous Rectification in DC to DC Converters,” Application Note AN2012-03, V2.1, 2012-03, [Application Note OptiMOS™ Simple Design Techniques for Optimizing Synchronous Rectification \(infineon.com\)](#)
- [7] Infineon Technology AG, “LLC Converter Design,” Application Note AN2013-03, V1.0, 2013-03, [LLC Converter Design \(mouser.com\)](#)
- [8] Infineon Technology AG, “Bootstrap Network Analysis: Focusing on the Integrated Bootstrap Functionality,” Application Note AN-1123, [Bootstrap Network Analysis: Focusing on the Integrated Bootstrap Functionality \(infineon.com\)](#)
- [9] Infineon Technology AG, “Design of a 600 W HB LLC Converter using 600 V CoolMOS™ P 6,” Application Note AN2015-07-31, V1.0, 2015-07-31, [Application Note OptiMOS™ Simple Design Techniques for Optimizing Synchronous Rectification \(infineon.com\)](#)

References and appendices

- [10] Lu, Bing. "Chapter 4. High Frequency LLC Resonant Converter 4.1 Introduction Figure 4-1. 1200w Front-end Ac/ Dc Converter." (2008), <https://www.semanticscholar.org/paper/Chapter-4.-High-Frequency-Llc-Resonant-Converter-F-Lu>

5.3 Additional information

In the following links, you can find more detailed information about the devices used by Infineon and about magnetic components.

- Primary-side high-side and low-side driver: **SOI gate driver** [2ED2101S06F](#)
- Primary-side high-power switches: Infineon's **CoolMOS™ P6 super junction MOSFET** [IPL60R650P6S](#)
- Transformer driver and synchronous rectification driver [2ED24427N01F](#) - **dual channel low side driver**,
- Synchronous rectifier switches **OptiMOS™** [BSC022N04LS6](#),
- **LLC analog controller** [ICE2HS01G](#) with integrated synchronous rectification control
- **QR flyback controller** [ICE5QSAG](#) for auxiliary supply circuit
- **Main power transformer** from [Sunlord Inc.](#)

Revision history

Revision history

Document version	Date of release	Description of changes
1.0	March 05, 2021	Initial creation

Trademarks

All referenced product or service names and trademarks are the property of their respective owners.

Edition 2021-03-05

Published by

Infineon Technologies AG

81726 Munich, Germany

© 2021 Infineon Technologies AG.

All Rights Reserved.

Do you have a question about this document?

Email: erratum@infineon.com

Document reference

UG-2021-02

For further information on the product, technology, delivery terms and conditions and prices please contact your nearest Infineon Technologies office (www.infineon.com).

WARNINGS

Due to technical requirements products may contain dangerous substances. For information on the types in question please contact your nearest Infineon Technologies office.

Except as otherwise explicitly approved by Infineon Technologies in a written document signed by authorized representatives of Infineon Technologies, Infineon Technologies' products may not be used in any applications where a failure of the product or any consequences of the use thereof can reasonably be expected to result in personal injury.