

# High Temperature 200°C, Radial, Molded, X7R Dielectric, 50 – 200 VDC (Industrial Grade)

## Overview

KEMET's High Temperature 200°C epoxy molded radial through-hole ceramic capacitors in X7R dielectric feature a robust and proprietary dielectric system that offers industry-leading performance in extreme high pressure and high temperature environments up to 200°C. These capacitors are designed specifically to withstand the severe shock and vibration conditions associated with deep-well and horizontal drilling activities and are well suited for use in aerospace engine compartments, geophysical probes, hybrid and electric automotive motor drives and defense applications.

As high temperature electronic module complexity increases, the size reduction of components becomes more and more critical. These devices are significantly smaller by volume than most competitor radial molded capacitors, allowing for downsizing and replacement opportunities of larger high temperature precious metal electrode (PME) and base metal electrode (BME) dielectric system devices. They feature gold-plated lead wires for temperature resistance and an epoxy molded case for environmental protection and mechanical durability.

These epoxy molded radial through-hole ceramic capacitors in X7R dielectric achieve high dielectric breakdown, low leakage current and minimal parametric shift while maintaining predictable performance characteristics with respect to variations in temperature, applied voltage and time. These devices are suited for bypass and decoupling applications or for frequency discriminating circuits where Q and stability of capacitance characteristics are not critical. Capacitance change is limited to  $\pm 15\%$  from  $-55^{\circ}\text{C}$  to  $+125^{\circ}\text{C}$  and  $+15\%/-55\%$  at  $+200^{\circ}\text{C}$ .

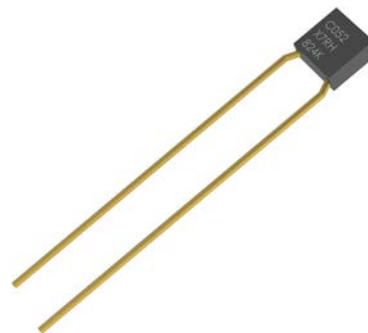

## Ordering Information

C	062	H	105	K	5	R	5	G	A	7303
Ceramic	Style/Size	Specification/Series	Capacitance Code (pF)	Capacitance Tolerance <sup>1</sup>	Rated Voltage (VDC)	Dielectric	Design	Lead Finish <sup>2</sup>	Failure Rate	Packaging C-Spec <sup>3</sup>
	052 062	H = High temperature 200°C	Two significant digits and number of zeros Use 9 for 1.0 – 9.9 pF e.g., 2.2 pF = 229	J = $\pm 5\%$ K = $\pm 10\%$ M = $\pm 20\%$	5 = 50 1 = 100 2 = 200	R = X7R	5 = Multilayer	G = Gold (Au)	A = N/A	Blank = Bulk Bag T250 = 250 pcs/ 12" reel T500 = 500 pcs/ 12" reel T1K0 = 1,000 pcs/ 12" reel 7301 = Full reel qty/ 12" reel 7303 = Full reel qty/ 12" reel 7061 = Bulk tray

<sup>1</sup> Additional capacitance tolerance offerings may be available. Contact KEMET for details.

<sup>2</sup> Wire lead materials and finishes: Alternative lead materials and finishes may be available. Contact KEMET for details.

<sup>3</sup> Default packaging for this product series is "Bulk Bag". KEMET will assume "Bulk Bag" packaging is required when the 15th thru 18th character positions are left blank.

<sup>3</sup> C-Spec 7301 can only be used when ordering 052 style/size.

<sup>3</sup> C-Spec 7303 can only be used when ordering 062 style/size.

## Dimensions – Inches (Millimeters)

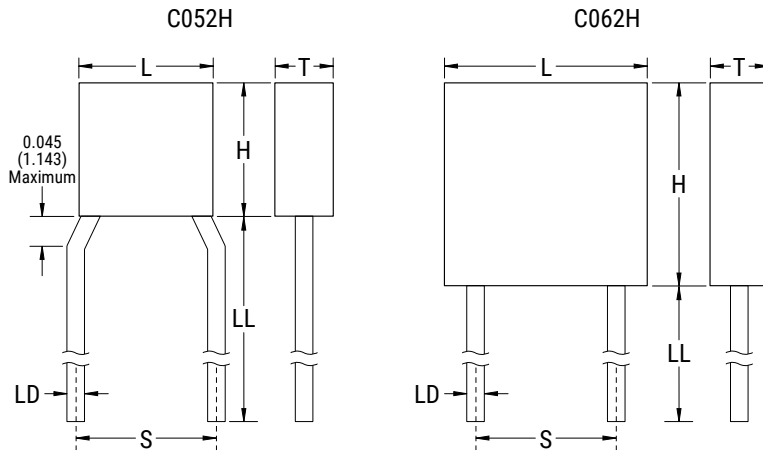

Series	S Lead Spacing	L Length	H Height	T Thickness	LD Lead Diameter	LL Lead Length Minimum
C052H	0.20±0.015 (5.08±0.38)	0.19±0.01 (4.83±0.25)	0.19±0.01 (4.83±0.25)	0.09±0.01 (2.29±0.25)	0.025+0.004/-0.002 (0.635+0.102/-0.051)	1.25 (31.75)
C062H		0.29±0.01 (7.37±0.25)	0.29±0.01 (7.37±0.25)	0.09±0.01 (2.29±0.25)		

## Benefits

- Operating temperature range of -55°C to +200°C
- X7R temperature stable dielectric
- High shock and vibration capability
- Radial through-hole form factor
- Gold (Au) plated wire lead finish
- Base metal electrode (BME) and precious metal electrode (PME) dielectric systems.
- RoHS and REACH compliant (most select values)
- Military designation styles CK/CKR05 and CK/CKR06
- Molded case
- High breakdown voltage strength
- DC voltage ratings of 50 V, 100 V and 200 V
- Capacitance offerings ranging from 1,000 pF to 1.0 µF
- Available capacitance tolerances of ±5%, ±10% and ±20%
- Low ESR and ESL
- Predictable performance characteristics with respect to variations in temperature, applied voltage and time
- Non-polar device, minimizing installation concerns
- Encapsulation meets flammability standard UL 94V-0
- Halogen-free

## Applications

Typical applications include decoupling, bypass, smoothing circuits, DC/DC converters, power supplies (input/output filters), noise reduction (piezoelectric/mechanical), circuits with a direct battery or power source connection, critical and safety relevant circuits without (integrated) current limitation and any application that is subject to extreme environments such as high shock and vibration, high temperature, high levels of board flexure and/or temperature cycling. Markets include military, industrial, aerospace, and automotive.

## Qualification

These devices are subject to internal qualification. Details regarding test methods and conditions are referenced in Table 2, Performance & Reliability.

## Environmental Compliance

RoHS compliance is dependent upon series and rated capacitance value.

Series	Rated Capacitance	RoHS Compliant	RoHS Exemption Code <sup>1</sup>	Halogen Free
C052H	All	Yes	7(a)	Yes
C062H	< 0.27µF	Yes	7(a)	Yes
C062H	≥ 0.27µF	No	n/a	Yes

<sup>1</sup> 7(a): Lead in high melting temperature type solders

## Electrical Parameters/Characteristics

Item	Parameters/Characteristics
Operating Temperature Range	-55°C to +200°C
Capacitance Change with Reference to +25°C and 0 VDC Applied (TCC)	±15% (-55°C to +125°C), +15%/-55% (200°C)
Capacitance Change with Reference to +25°C and 100% Rated VDC Applied	+15%/-30% (-55°C to +125°C), +15%/-60% (200°C)
Aging Rate (Maximum % Cap Loss/Decade Hour)	3%
Dielectric Withstanding Voltage	250% of rated voltage (5±1 seconds and charge/discharge not exceeding 50 mA at 25°C)
Dissipation Factor (DF) Maximum Limit at 25°C	2.50%
Insulation Resistance (IR) Limit at 25°C	1,000 MΩ microfarads or 100 GΩ (Rated voltage applied for 120±5 seconds)

Regarding aging rate: Capacitance measurements (including tolerance) are indexed to a referee time of 1,000 hours.

To obtain IR limit, divide MΩ-µF value by the capacitance and compare to GΩ limit. Select the lower of the two limits.

Capacitance and dissipation factor (DF) measured under the following conditions:

1 kHz ±50 Hz and 1.0 ±0.2 V<sub>rms</sub> if capacitance ≤ 10 µF

120 Hz ±10 Hz and 0.5 ±0.1 V<sub>rms</sub> if capacitance > 10 µF

Note: When measuring capacitance it is important to ensure the set voltage level is held constant. The HP4284 and Agilent E4980 have a feature known as Automatic Level Control (ALC). The ALC feature should be switched to "ON."

## Post Environmental Limits

High Temperature Life, Biased Humidity, Moisture Resistance					
Dielectric	Rated DC Voltage	Capacitance Value	DF (%)	Capacitance Shift	IR
X7R	> 25	All	3.0	±20%	10% of Initial Limit

**Table 1A – C052 Style/Size (0.20" Lead Spacing), Capacitance Range Waterfall**

C052 Style/Size (0.20" Lead Spacing)				
Rated Voltage (VDC)		50	100	200
Voltage Code		5	1	2
Capacitance	Capacitance Tolerance	Capacitance Code (Available Capacitance)		
1,000 pF	J = ±5% K = ±10% M = ±20%	C052H102(1)5R5GA(2)	C052H102(1)1R5GA(2)	C052H102(1)2R5GA(2)
1,200 pF		C052H122(1)5R5GA(2)	C052H122(1)1R5GA(2)	C052H122(1)2R5GA(2)
1,500 pF		C052H152(1)5R5GA(2)	C052H152(1)1R5GA(2)	C052H152(1)2R5GA(2)
1,800 pF		C052H182(1)5R5GA(2)	C052H182(1)1R5GA(2)	C052H182(1)2R5GA(2)
2,200 pF		C052H222(1)5R5GA(2)	C052H222(1)1R5GA(2)	C052H222(1)2R5GA(2)
2,700 pF		C052H272(1)5R5GA(2)	C052H272(1)1R5GA(2)	C052H272(1)2R5GA(2)
3,300 pF		C052H332(1)5R5GA(2)	C052H332(1)1R5GA(2)	C052H332(1)2R5GA(2)
3,900 pF		C052H392(1)5R5GA(2)	C052H392(1)1R5GA(2)	
4,700 pF		C052H472(1)5R5GA(2)	C052H472(1)1R5GA(2)	
5,600 pF		C052H562(1)5R5GA(2)	C052H562(1)1R5GA(2)	
6,800 pF		C052H682(1)5R5GA(2)	C052H682(1)1R5GA(2)	
8,200 pF		C052H822(1)5R5GA(2)	C052H822(1)1R5GA(2)	
0.01 µF		C052H103(1)5R5GA(2)	C052H103(1)1R5GA(2)	
0.012 µF		C052H123(1)5R5GA(2)	C052H123(1)1R5GA(2)	
0.015 µF		C052H153(1)5R5GA(2)	C052H153(1)1R5GA(2)	
0.018 µF		C052H183(1)5R5GA(2)	C052H183(1)1R5GA(2)	
0.022 µF		C052H223(1)5R5GA(2)	C052H223(1)1R5GA(2)	
0.027 µF		C052H273(1)5R5GA(2)	C052H273(1)1R5GA(2)	
0.033 µF		C052H333(1)5R5GA(2)	C052H333(1)1R5GA(2)	
0.039 µF		C052H393(1)5R5GA(2)	C052H393(1)1R5GA(2)	
0.047 µF		C052H473(1)5R5GA(2)	C052H473(1)1R5GA(2)	
0.056 µF	C052H563(1)5R5GA(2)			
0.068 µF	C052H683(1)5R5GA(2)			
0.082 µF	C052H823(1)5R5GA(2)			
0.1 µF	C052H104(1)5R5GA(2)			
Rated Voltage (VDC)		50	100	200
Voltage Code		5	1	2

- (1) To complete ordering code, insert the proper character for capacitance tolerance: (See table above for character definitions)
- (1) Available capacitance tolerances: J, K, M
- (2) To complete ordering code, enter the four-digit numeric or alphanumeric "Packaging C-Spec Ordering Code." See details below:
- Blank = Bulk Bag
  - T250 = 250 pcs / 12" Reel
  - T500 = 500 pcs / 12" Reel
  - T1K0 = 1,000 pcs / 12" reel
  - 7301 = Full Reel Qty / 12" reel
  - 7303 = Full Reel Qty / 12" reel
  - 7061 = Bulk Tray

These products are protected under U.S. Patents 7172985 and 7670981, other patents pending, and any foreign counterparts.

**Table 1B – C062 Style/Size (0.20" Lead Spacing), Capacitance Range Waterfall**

C062 Style/Size (0.20" Lead Spacing)					
Rated Voltage (VDC)		50	100	200	
Voltage Code		5	1	2	
Capacitance	Capacitance Tolerance	Capacitance Code (Available Capacitance)			
4,700 pF	J = ±5% K = ±10% M = ±20%			C062H472(1)2R5GA(2)	
5,600 pF				C062H562(1)2R5GA(2)	
6,800 pF				C062H682(1)2R5GA(2)	
0.056 µF					
0.068 µF				C062H563(1)1R5GA(2)	
0.082 µF				C062H683(1)1R5GA(2)	
0.1 µF				C062H823(1)1R5GA(2)	
0.12 µF				C062H104(1)1R5GA(2)	
0.15 µF				C062H124(1)1R5GA(2)	
0.18 µF			C062H124(1)5R5GA(2)		
0.22 µF			C062H154(1)5R5GA(2)		
0.27 µF			C062H184(1)5R5GA(2)		
0.33 µF			C062H224(1)5R5GA(2)		
0.39 µF			C062H274(1)5R5GA(2)		
0.47 µF			C062H334(1)5R5GA(2)		
0.56 µF			C062H394(1)5R5GA(2)		
0.68 µF			C062H474(1)5R5GA(2)		
0.82 µF			C062H564(1)5R5GA(2)		
1.0 µF			C062H684(1)5R5GA(2)		
			C062H824(1)5R5GA(2)		
		C062H105(1)5R5GA(2)			
Rated Voltage (VDC)		50	100	200	
Voltage Code		5	1	2	

- (1) To complete ordering code, insert the proper character for capacitance tolerance: (See table above for character definitions)  
 (1) Available capacitance tolerances: J, K, M  
 (2) To complete ordering code, enter the four-digit numeric or alphanumeric "Packaging C-Spec Ordering Code." See details below:  
 Blank = Bulk Bag  
 T250 = 250 pcs / 12" Reel  
 T500 = 500 pcs / 12" Reel  
 T1K0 = 1,000 pcs / 12" reel  
 7301 = Full Reel Qty / 12" reel  
 7303 = Full Reel Qty / 12" reel  
 7061 = Bulk Tray

These products are protected under U.S. Patents 7172985 and 7670981, other patents pending, and any foreign counterparts.

## Packaging Quantities

Packaging Options		Bulk Bag (default) <sup>1</sup>	Bulk Tray	Tape and Reel				
		Packaging Quantities <sup>3</sup>						
Ordering Code C-Spec <sup>2</sup>		n/a	7061	T250	T500	T1K0	7301	7303
Style/ Series	C052H	100 pcs/bag	50 pcs/tray	250	500	1,000	2,000	n/a
	C062H	100 pcs/bag	40 pcs/tray	250	500	1,000	n/a	1,500

<sup>1</sup> Default packaging for this product series is "Bulk Bag". KEMET will assume "Bulk Bag" packaging is required unless a valid C-spec is included in the 15th thru 18th character positions of the ordering code. For more information see "Ordering Information" section of this document.

<sup>2</sup> The "Ordering Code C-Spec" is a four-digit code that follows the KEMET part number and identifies any special packaging or processing requirements. Failure to include a C-Spec when ordering will result in the default packaging option. Default packaging for this product series is "Bulk Bag".

<sup>3</sup> Packaging quantities reported above are considered "minimum order quantities" and are mandatory.

## Soldering Process

### Recommended Soldering Technique:

- Solder Wave
- Hand Soldering (Manual)

### Recommended Soldering Profile:

- Optimum Wave Solder Profile

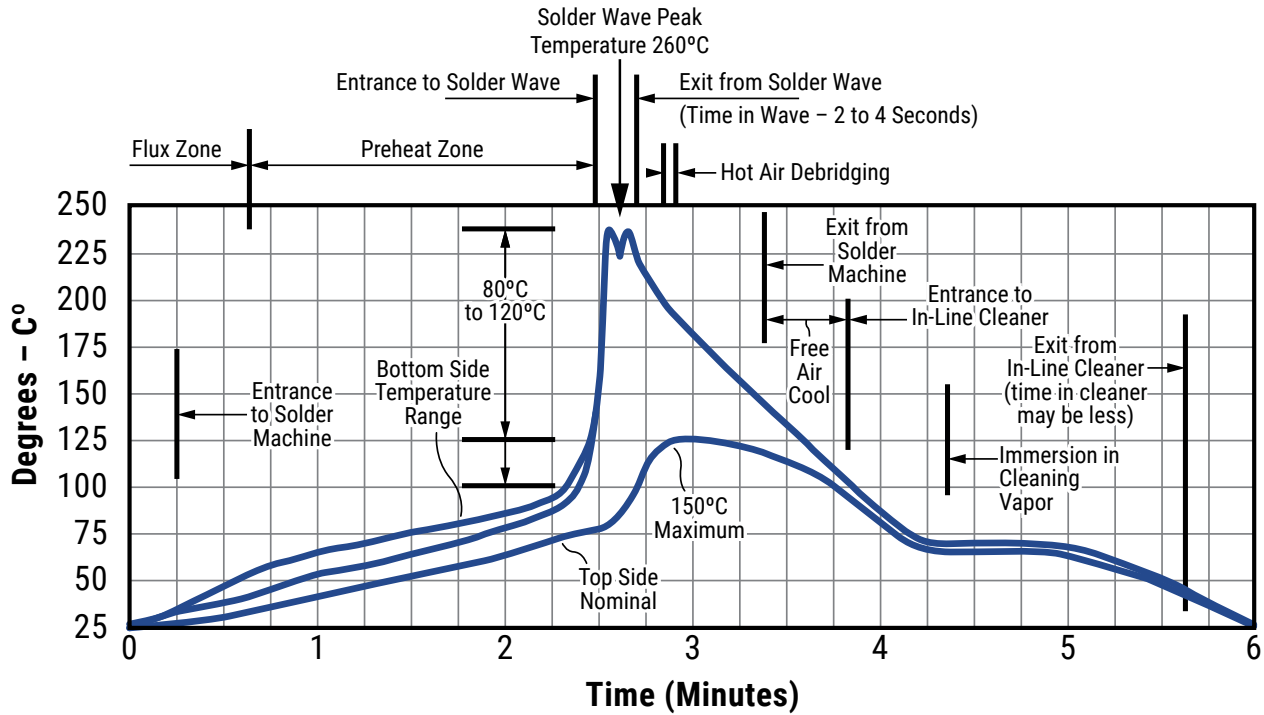

- Hand Soldering (Manual)

### Manual Solder Profile with Pre-heating

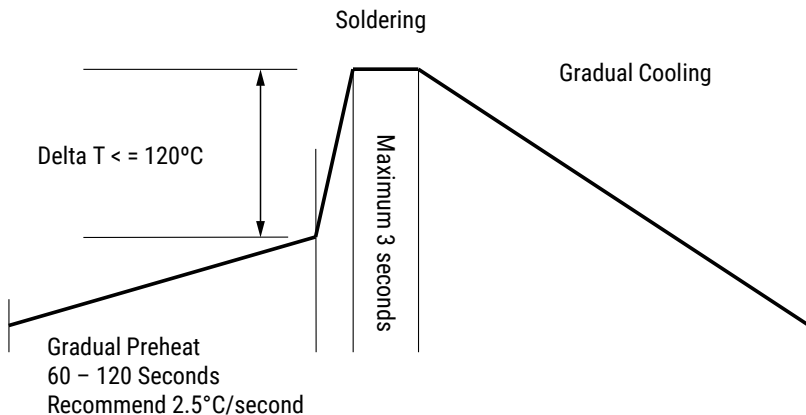

KEMET recommends following the guidelines and techniques outlined in technical bulletins F2103 and F9207.

**Table 2 – Performance & Reliability: Test Methods and Conditions**

Stress	Reference	Test or Inspection Method
Solderability	J-STD-002	Method A at 235°C, category 3
Temperature Cycling	JESD22 Method JA-104	50 cycles (-55°C to 220°C), measurement at 24 ±4 hours after test conclusion. 30 minutes maximum dwell time at each temperature extreme. 8 minutes maximum transition time.
Biased Humidity	MIL-STD-202 Method 103	Load humidity: 1,000 hours 85°C/85% RH and rated voltage. Add 100 K ohm resistor. Measurement at 24 hours ±4 hours after test conclusion.
		Low volt humidity: 1,000 hours 85°C/85% RH and 1.5 V. Add 100 K ohm resistor. Measurement at 24 hours ±4 hours after test conclusion.
Immersion	MIL-STD-202 Method 104	Test condition B
Storage Life	MIL-STD-202 Method 108	Unpowered 1,000 hours at 200°C. Measurement at 24 hours ±4 hours after test conclusion. IR Measurement at 150°C
High Temperature Life	MIL-STD-202 Method 108	1,000 hours at 200°C with rated voltage applied.
High Temperature Lead Pull	KEMET Defined Test	Peel to Failure (25°C and 200°C): 4 lbs (1.84 kg) minimum
Vibration	MIL-STD-202 Method 204	5g for 20 minutes, 12 cycles each of 3 orientations. Note: Use 8" X 5" PCB. 031" thick 7 secure points on one long side and 2 secure points at corners of opposite sides. Parts mounted within 2" from any secure point. Test from 10 – 2000 Hz.
Resistance to Soldering Heat	MIL-STD-202 Method 210	Test Condition B, Solder dip. Note: no preheat of samples.
Terminal Strength	MIL-STD-202 Method 211	Test Condition A. 454g 5 – 10 s; Bend test @ 227g, 3 bends
Mechanical Shock	MIL-STD-202 Method 213	Test Condition D. Figure 1 of Method 213.
Resistance to Solvents	MIL-STD-202 Method 215	Add aqueous wash chemical – OKEM Clean or equivalent.

## Storage & Handling

The un-mounted storage life of a through-hole (leaded) ceramic capacitor is dependent upon storage and atmospheric conditions as well as packaging materials. While the ceramic chips enveloped under the epoxy coating themselves are quite robust in most environments, solderability of the wire lead on the final epoxy-coated product will be degraded by exposure to high temperatures, high humidity, corrosive atmospheres, and long term storage. In addition, packaging materials will be degraded by high temperature and exposure to direct sunlight—reels may soften or warp, and tape peel force may increase. KEMET recommends storing the un-mounted capacitors in their original packaging, in a location away from direct sunlight, and where the temperature and relative humidity do not exceed 40 degrees centigrade and 70% respectively. For optimum solderability, capacitor stock should be used promptly, preferably within 18 months of receipt. For applications requiring pre-tinning of components, storage life may be extended if solderability is verified. Before cleaning, bonding or molding these devices, it is important to verify that your process does not affect product quality and performance. KEMET recommends testing and evaluating the performance of a cleaned, bonded or molded product prior to implementing and/or qualifying any of these processes.

## Application Notes

### Working Voltage:

Application voltage ( $V_{p-p}$  or  $V_{o-p}$ ) must not exceed the voltage rating of the capacitor. Irregular voltages can be generated for a transient period of time when voltage is initially applied and/or removed from a circuit. It is important to choose a capacitor with a voltage rating greater than or equal to these irregular voltages.

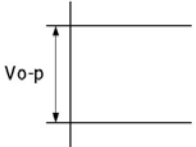
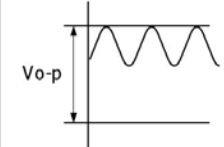
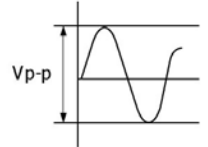
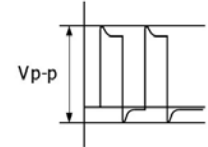
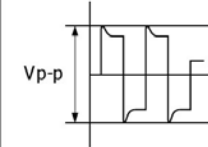
Voltage	DC Voltage	DC+AC Voltage	AC Voltage	Pulse Voltage (1)	Pulse Voltage (2)
Positional Measurement					

### Operating Temperature and Self-Generating Heat:

The surface temperature of a capacitor should be kept below the upper limit of its rated operating temperature range. Be sure to take into account the heat generated by the capacitor itself. When the capacitor is used in a high-frequency current, pulse current or similar current, it may self-generate heat due to dielectric loss. Temperature rise due to self-generated heating should not exceed 20°C (while operated at an atmosphere temperature of 25°C).

**FAILURE TO FOLLOW THE ABOVE CAUTIONS MAY RESULT, WORST CASE, IN A SHORT CIRCUIT AND CAUSE FUMING OR PARTIAL DISPERSION WHEN THE PRODUCT IS USED.**



## Construction

### Base Metal Electrode

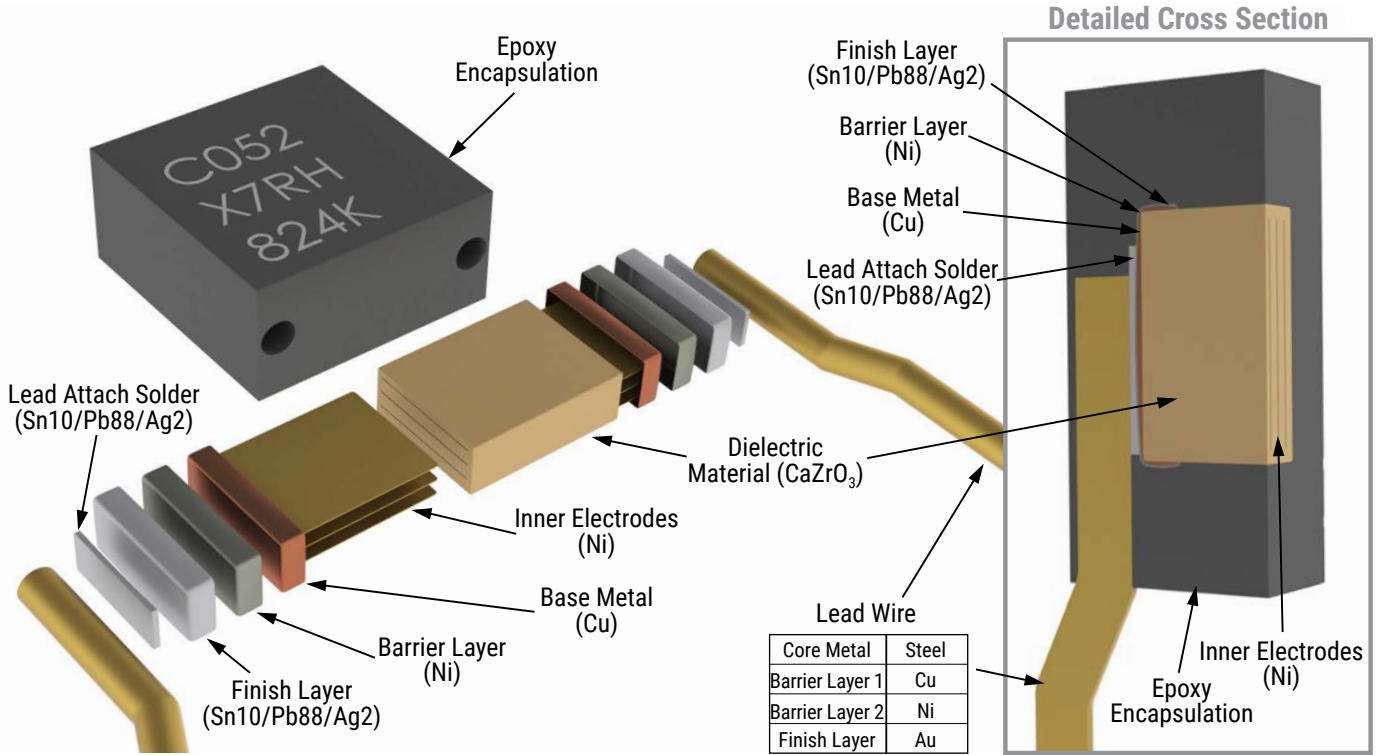

### Precious Metal Electrode

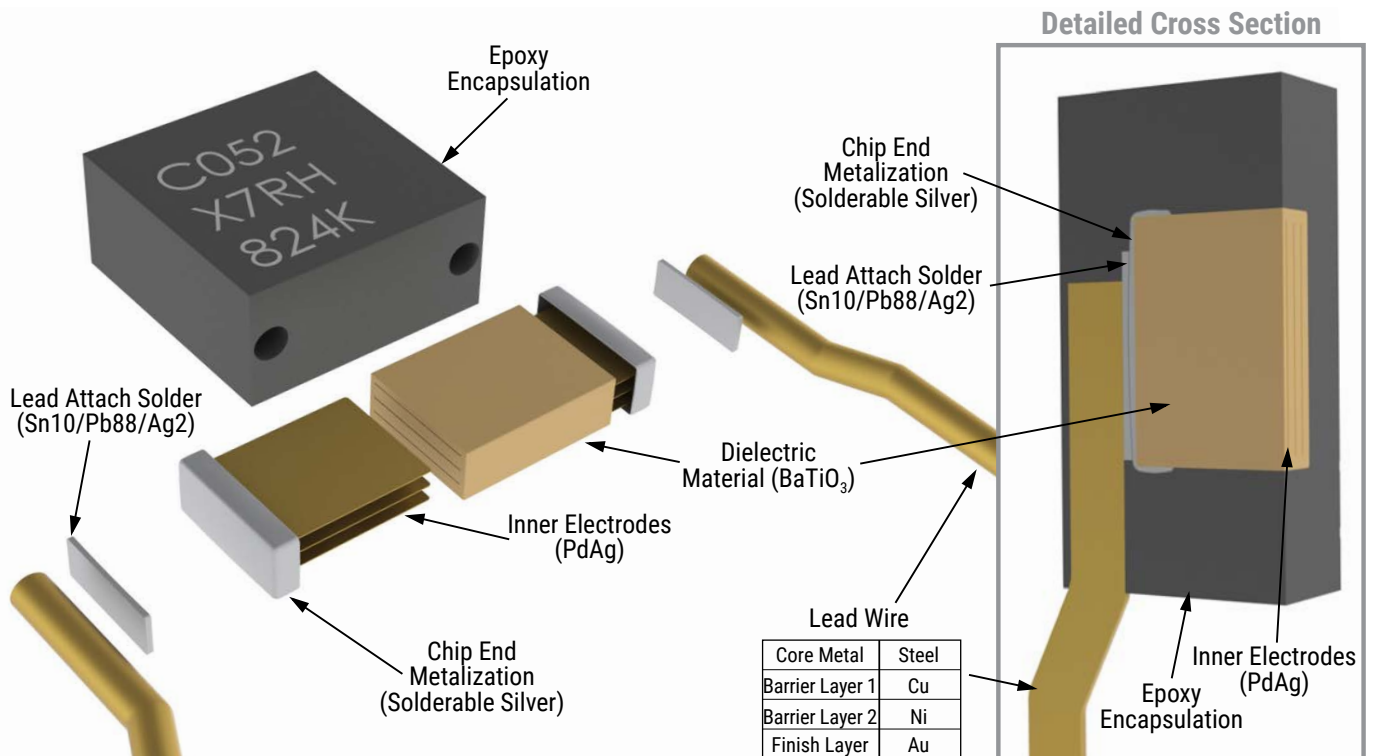

## Marking

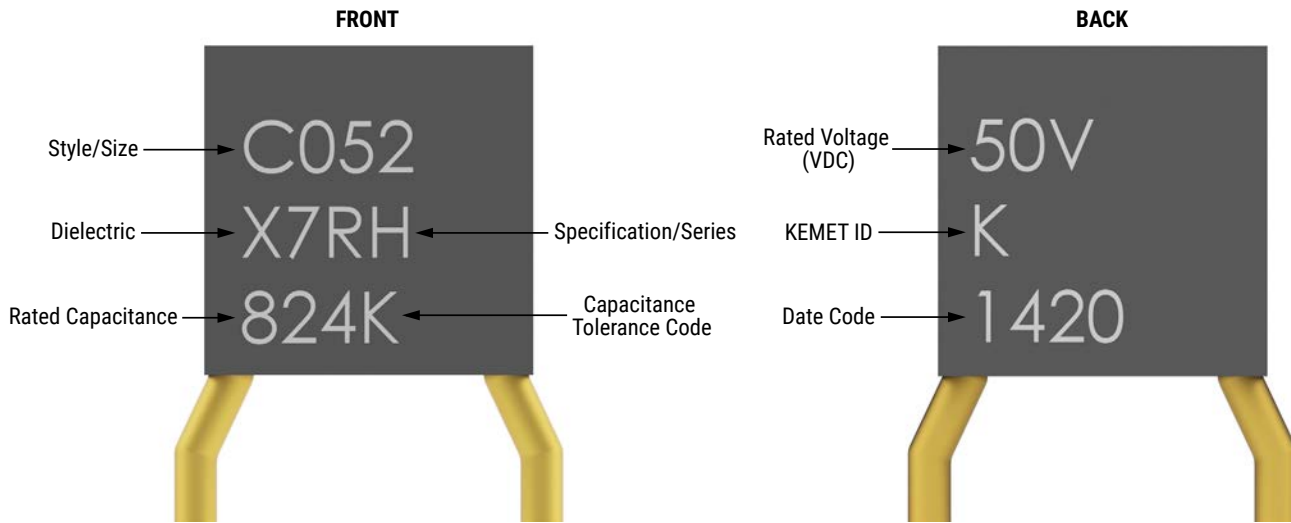

Date Code	
14	20
Manufacturing Year: 14 = 2014	Manufacturing Week: 20 = Week 20 (of mfg. calendar year)

## Lead Tape & Reel Packaging Information

KEMET offers standard reeling of Molded Radial Leaded Capacitors in accordance with EIA standard 468. Parts are taped to a tag board carrier strip, and wound on a reel as shown in Figure 1. Kraft paper interleaving is inserted between the layers of capacitors on the reel.

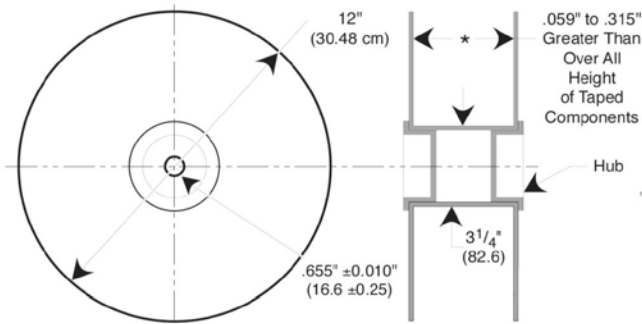

Figure 3: Standard Reel

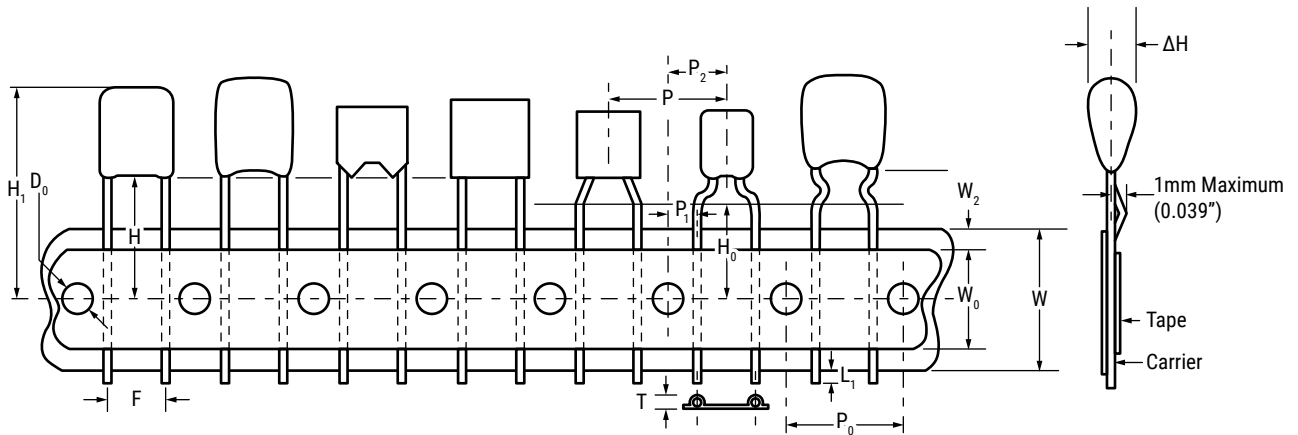
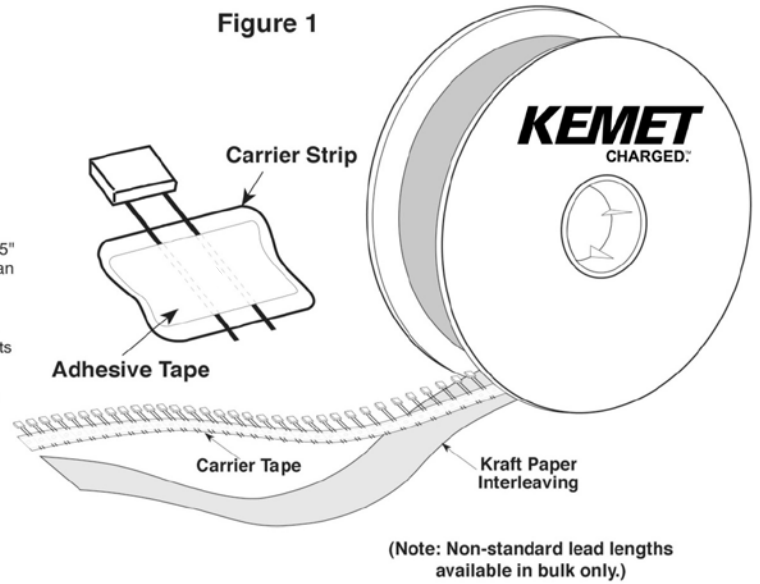

Figure 2: Lead Tape Configuration (See Table Below)

**Table 3 – Ceramic Radial Tape and Reel Dimensions**

Metric will govern

Constant Dimensions – Millimeters (Inches)										
$D_0$ ±0.2 (0.008)	$P_0$ ±0.3 (0.012)	P ±0.3 (0.012)	$P_2$ ±0.7 (0.028)	$\Delta H$ Maximum	$L_1$ Maximum	t Maximum	T Maximum	W + 1.0/-0.5 (+0.039/-0.020)	$W_0$ Minimum	$W_2$ Maximum
4.00 (0.157)	12.7 (0.500)	12.7 (0.500)	6.35 (0.250)	1.0 (0.039)	1.0 (0.039)	0.9 (0.035)	2.0 (0.079)	18.0 (0.709)	5.0 (0.197)	3.0 (0.118)

Variable Dimensions – Millimeters (Inches)			
F +0.6 (0.024) -0.2 (0.008) Note 1	$P_1$ ±0.7 (0.028) Note 1	H Minimum Note 2	$H_0$ ±0.5 (0.630) Note 3
2.54 (0.100)	5.08 (0.200)	18.0 (0.709)	16.0 (0.024)
4.32 (0.170)	3.89 (0.153)		
5.08 (0.200)	3.81 (0.150)		
5.59 (0.220)	3.25 (0.128)		
6.98 (0.275)	2.54 (0.100)		
7.62 (0.300)	2.24 (0.088)		
9.52 (0.375)	7.62 (0.300)		
10.16 (0.400)	7.34 (0.290)		
12.06 (0.475)	6.35 (0.250)		
14.60 (0.575)	5.08 (0.200)		
17.14 (0.675)	3.81 (0.15)		

Symbol Reference Table	
$D_0$	Sprocket Hole Diameter
$P_0$	Sprocket Hole Pitch
P	Component Pitch
F	Lead Spacing
$P_1$	Sprocket Hole Center to Adjacent Component Lead
$P_2$	Sprocket Hole Center to Component Center
H	Height to Seating Plane (Straight Leads Only)
$H_0$	Height to Seating Plane (Formed Leads Only)
$H_1$	Component Height Above Tape Center
$\Delta H$	Component Alignment
$L_1$	Lead Protrusion
t	Composite Tape Thickness
W	Carrier Tape Width
$W_0$	Hold-Down Tape Width
$W_2$	Hold-Down Tape Location

1. Measured at the egress from the carrier tape, on the component side.
2. Straight Lead configuration part types only.
3. Formed (bent) lead configuration part types only.

## KEMET Electronics Corporation Sales Offices

For a complete list of our global sales offices, please visit [www.kemet.com/sales](http://www.kemet.com/sales).

---

### Disclaimer

All product specifications, statements, information and data (collectively, the "Information") in this datasheet are subject to change. The customer is responsible for checking and verifying the extent to which the Information contained in this publication is applicable to an order at the time the order is placed. All Information given herein is believed to be accurate and reliable, but it is presented without guarantee, warranty, or responsibility of any kind, expressed or implied.

Statements of suitability for certain applications are based on KEMET Electronics Corporation's ("KEMET") knowledge of typical operating conditions for such applications, but are not intended to constitute – and KEMET specifically disclaims – any warranty concerning suitability for a specific customer application or use. The Information is intended for use only by customers who have the requisite experience and capability to determine the correct products for their application. Any technical advice inferred from this Information or otherwise provided by KEMET with reference to the use of KEMET's products is given gratis, and KEMET assumes no obligation or liability for the advice given or results obtained.

Although KEMET designs and manufactures its products to the most stringent quality and safety standards, given the current state of the art, isolated component failures may still occur. Accordingly, customer applications which require a high degree of reliability or safety should employ suitable designs or other safeguards (such as installation of protective circuitry or redundancies) in order to ensure that the failure of an electrical component does not result in a risk of personal injury or property damage.

Although all product-related warnings, cautions and notes must be observed, the customer should not assume that all safety measures are indicated or that other measures may not be required.

*KEMET is a registered trademark of KEMET Electronics Corporation.*