

DESCRIPTION: VERTICAL MOUNT - FEMALE - LOW PROFILE - PLASTIC BACK

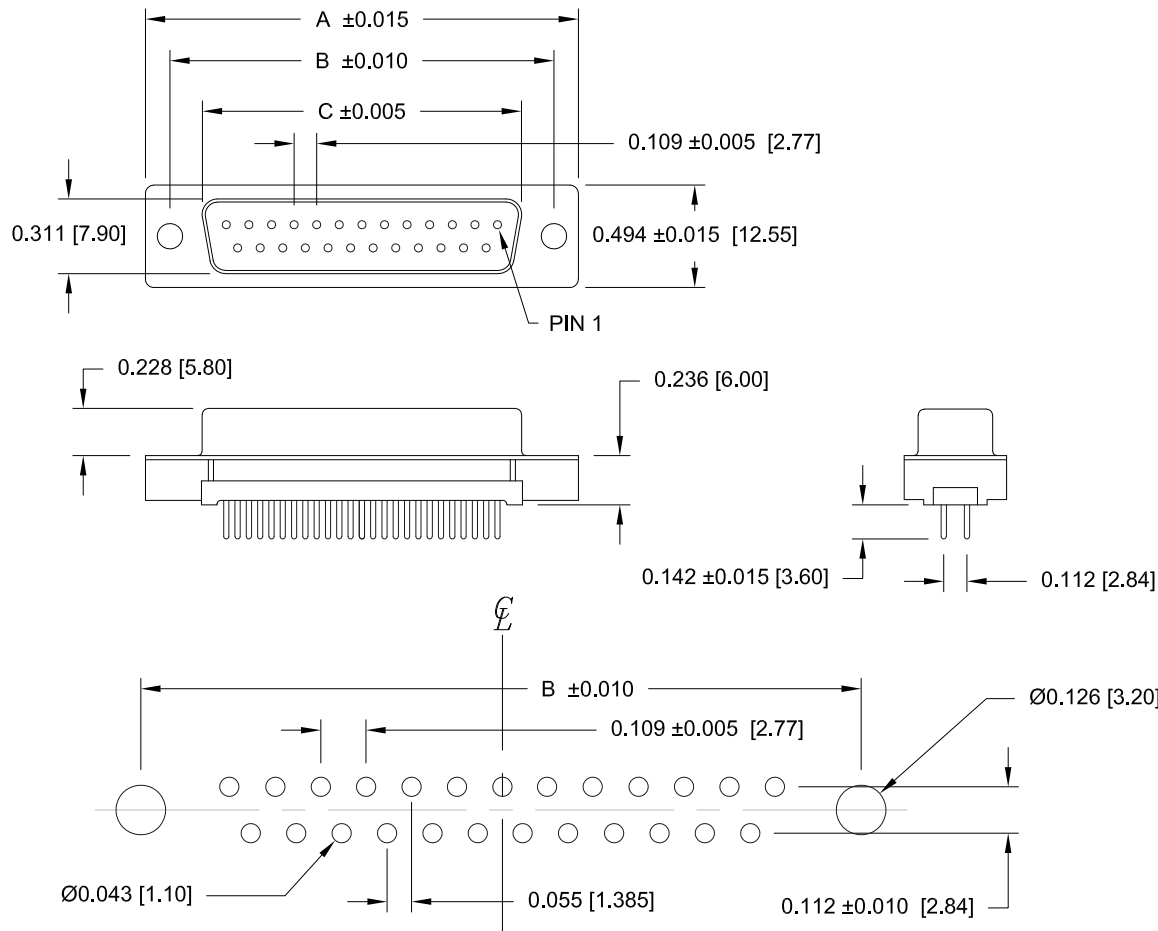

RECOMMENDED PCB LAYOUT

MATERIAL:

INSULATOR: THERMOPLASTIC POLYESTER, UL94-0, CHEMICAL RESISTANCE, BLACK, 230°C PROCESS TEMP.
 SHELL: STEEL, NICKEL PLATED
 CONTACT: PHOSPHOR BRONZE, GOLD FLASH OR 30 MICRO-INCH IN MATING AREA, TIN PLATED ON TAIL ENDS

ELECTRICAL:

CURRENT RATING: 3 AMPS
 WITHSTANDING VOLTAGE: 250 VAC (RMS) MAX
 INSULATION RESISTANCE: 5,000 MOhms Min.
 CONTACT RESISTANCE: 25 mOhms Max.
 WORKING TEMPERATURE: -55° TO +85°C

191-YYY-213LYYY



SERIES _____
 POSITIONS _____
 009 _____
 015 _____
 025 _____
 037 _____
 GENDER _____
 2 = FEMALE
 TERMINATION _____
 1 = SOLDER TAIL
 SHELL PLATING _____
 3 = STEEL, NICKEL PLATED
 RoHS COMPLIANT (LOW TEMP. PROCESS)
 HARDWARE OPTIONS _____
 00 = NO HARDWARE, 0.125 DIA. HOLE
 55 = 4-40 INSERT
 56 = 4-40 INSERT WITH BOARD LOCK
 57 = 4-40 STANDOFF WITH BOARD LOCK
 59 = 4-40 STANDOFF
 PLATING OPTIONS _____
 1 = GOLD FLASH
 2 = 30 MICRO-INCH GOLD

NUMBER OF CONTACTS	"A" Inch (mm)	"B" Inch (mm)	"C" Inch (mm)
9	1.213 (30.81)	.984 (24.99)	.643 (16.33)
15	1.543 (39.19)	1.312 (33.32)	.971 (24.66)
25	2.088 (53.04)	1.852 (47.04)	1.511 (38.38)
37	2.729 (69.32)	2.500 (63.50)	2.159 (54.84)

RoHS COMPLIANT

UNITS = INCHES [MM]

DO NOT SCALE FROM DRAWING

	THESE DRAWINGS AND SPECIFICATIONS ARE THE PROPERTY OF NorComp AND SHALL NOT BE REPRODUCED, COPIED OR USED AS THE BASIS FOR THE MANUFACTURE OF SALE OF APPARATUS WITHOUT WRITTEN PERMISSION.		DRAWN: PAM JENKINS	DATE: 8-22-05
			SCALE: NTS	SHEET 1 OF 2
			DWG NO. 191-YYY-213LYYY	

DESCRIPTION: 191 SERIES HARDWARE OPTIONS

00 = .125 DIA. HOLE

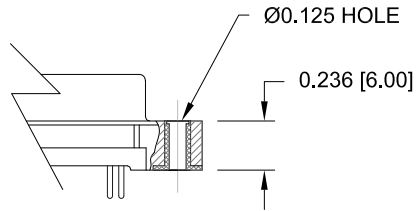

55 = 4-40 INSERT

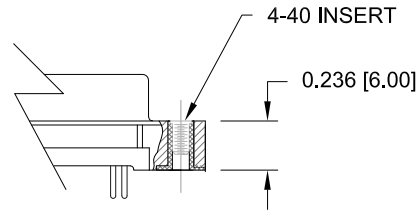

56 = 4-40 INSERT WITH BOARD LOCK

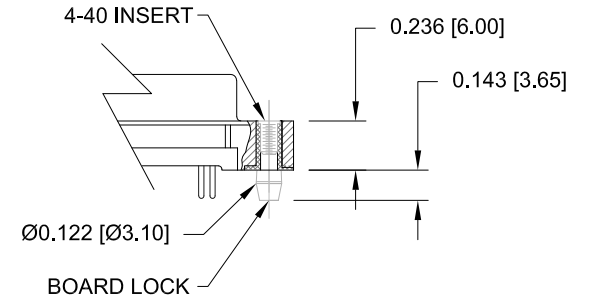

57 = 4-40 STANDOFF WITH BOARD LOCKS

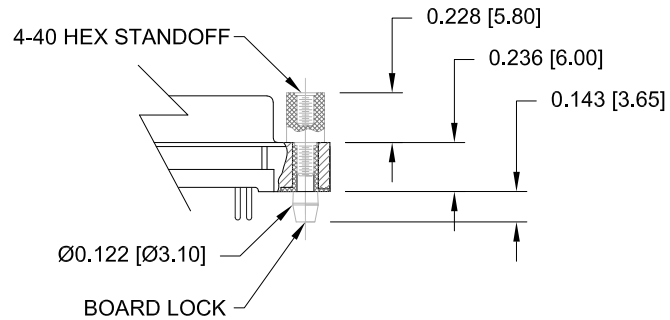

59 = 4-40 STANDOFF

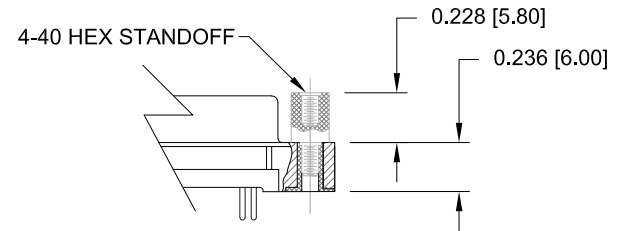

DO NOT SCALE FROM DRAWING



THESE DRAWINGS AND SPECIFICATIONS ARE THE PROPERTY OF NorComp AND SHALL NOT BE REPRODUCED, COPIED OR USED AS THE BASIS FOR THE MANUFACTURE OF SALE OF APPARATUS WITHOUT WRITTEN PERMISSION.

DRAWN:
PAM JENKINS

DATE:
8-22-05

NorComp

SCALE: NTS SHEET 2 OF 2 REV 7

DWG NO. 191-YYY-213LYYY

RoHS COMPLIANT