

T3EL150302P/T3EL150303P Data Sheet

Programmable Electronic Loads

Debug with Confidence

150 Volts, 30 Amps, 300 Watts



Tools for Improved Debugging

- 2 Models to choose from. Each model has a Low and High mode. ✓ Dual modes add more flexibility for better application coverage.
- 4 Operating modes: CC, CV, CR, CP ✓ Ideal for electronic components, battery, portable charger/adaptor and power products.
- Static, Dynamic and Sequence mode support. ✓ Generate a single static load right through to complex dynamic sequences for thorough product testing.
- Built in Application Functions: Short Circuit Test, Battery Test Mode, CR-LED Mode, OCP and OPP Test. ✓ Quickly set up common tests.
- Provides a load of up to 300 Watts. ✓ Ideal for low to medium power applications.
- Programmable and analog external control. ✓ Support for the maximum control flexibility.
- 3 years warranty as standard. ✓ Reliable product gives piece of mind.

Models and Characteristics

T3EL150302P	High Range	0 V – 150 V	0 – 30 A	200 Watts
	Low Range	0 V – 150 V	0 – 5 A	200 Watts
T3EL150303P	High Range	0 V – 150 V	0 – 30 A	300 Watts
	Low Range	0 V – 150 V	0 – 5 A	300 Watts

T3EL150303P

T3EL150302P

T3EL150302P/T3EL150303P series Programmable DC Electronic Load has a 3.5 inch TFT-LCD display, a user-friendly interface and superb performance specifications. The T3EL150302P models feature an input range of 150 V/30 A 200 W while the T3EL150303P have an input range of 150 V/30 A 300 W. The T3EL15030xP series leads with measurement resolution of 1 mV/1 mA and adjustable current rise times from 0.001 A/ μ s – 2.5 A/ μ s.

For remote communication and control, the T3EL15030xP series includes RS232/USB/LAN interface types. The T3EL15030xP series delivers stability over a wide range of applications and can meet all kinds of testing requirements. Including: Power, battery/handheld device design, industry, LED lighting, automotive electronics, and aerospace.



Main Feature

- T3EL150302P (Single channel): DC 150 V/30 A, total power up to 200 W
- T3EL150303P (Single channel): DC 150 V/30 A, total power up to 300 W
- 4 static modes / Dynamic mode: CC/CV/CR/CP
- CC Dynamic mode: Continuous, pulsed, toggled
- CC Dynamic mode: 25 kHz, CP Dynamic mode: 12.5 kHz, CV Dynamic mode: 0.5 Hz
- Measuring speed of voltage and current: up to 500 kHz
- Adjustable current rise time range: 0.001 A/ μ s – 2.5 A/ μ s
- Min. readback resolution: 1 mV, 1 mA
- Short-circuit, Battery test, CR-LED mode, and factory test functions
- 4-wire SENSE compensation mode function
- List function supports editing as many as 100 steps
- Program function supports 50 groups of steps
- OCP, OVP, OPP, OTP and LRV protection
- External analog control
- Voltage, Current monitoring via 0 – 10 V
- 3.5 inch TFT-LCD display, capable of displaying multiple parameters and states simultaneously
- Built-in RS232/USB/LAN communication interface
- Waveform trend chart and ease-to-use file storage and call functions
- Includes PC software: Supports SCPI, LabView driver

DESIGN FEATURES

Steady state operating mode

The T3EL15030xP features four operating modes to provide flexible test capabilities. In CC mode, the electronic load will sink a constant current, regardless of the voltage at its terminals. In CV mode, the electronic load will cause a constant voltage to appear at its terminals. In CR mode, the electronic load will behave as a fixed resistance value. As shown in the figure, the electronic load will linearly change the current according to the input voltage. In CP mode, the electronic load will cause a constant power to be dissipated in the load.

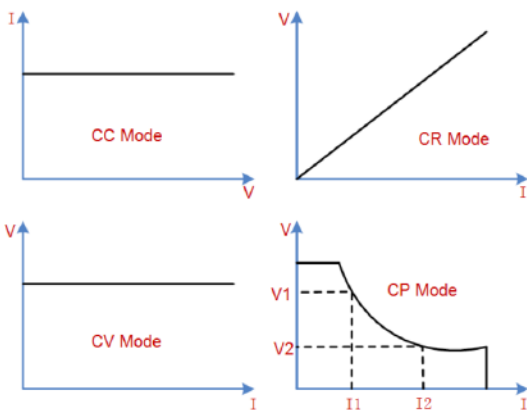

Simplify complex sequencing using the list operation function

You can generate complex load sequences quickly using the list operation function. Here, you can edit the set-points, dwell time, and slew rate for each step in the test. *Slew rate can only be edited in CC mode.

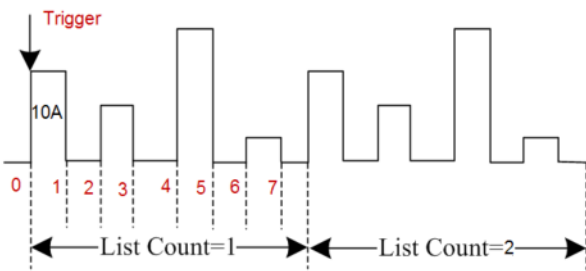

Step	1	2	3	4	5
Set (A)	2.000	2.000	2.000	2.000	2.000
Time (s)	1.000	1.000	1.000	1.000	1.000
Slo(A/us)	0.100	0.100	0.100	0.100	0.100

Function	I_Range	V_Range	Step
CC	30A	150V	100

Page 1/2

Dynamic test mode up to 25 kHz (CC)

The transient test allows switching between two different load values. A common application is to test the dynamic characteristics of a DC source or DUT (Device Under Test). The transient test function enables the load to periodically switch between two set levels (Level A and Level B). The highest frequency can be set to 25 kHz in CC mode. The highest frequency can be set to 12.5 kHz in CP modes.

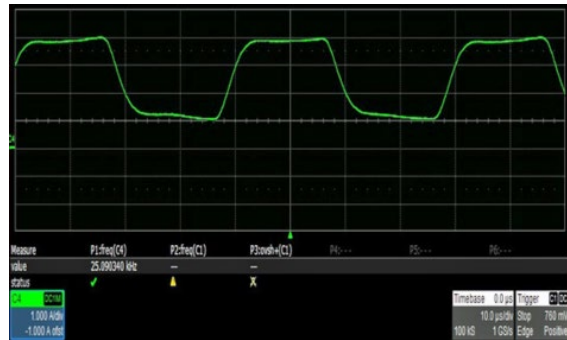

4-wire SENSE compensation mode function

In CC/CV/CR/CW mode, when a load is connected to a power supply, it will cause a large voltage-drop on the connection lines between tested instrument and terminals of load. Using remote sense, you can measure the voltage at the DUTs input terminals, effectively removing the additional error due to the voltage drop in the connection wires.

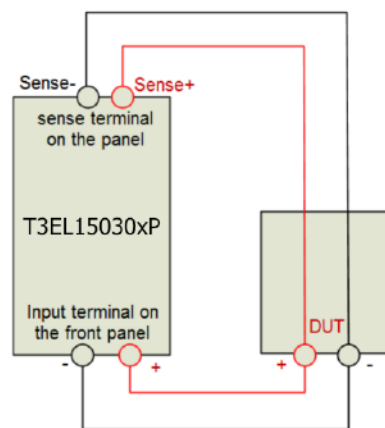

DESIGN FEATURES

Program function

In program (auto-test) mode, you can generate a sequence of tests using different modes, mode parameters and durations. This function is useful for automatically executing a set of tests on a device then display whether the tests passed or failed. Test results are easily viewed by pressing the up and down buttons. The load provides 8 nonvolatile registers to save auto-test file for recall later. Each file contains 1–50 steps to set up. Auto-test function is especially useful in the designing battery charging circuitry.

step	1	2	3	4	5
mode	CC	CC	CC	CC	CC
lrange	30A	30A	30A	30A	30A
Vrange	150V	150V	150V	150V	150V
paus	OFF	OFF	OFF	OFF	OFF
short	OFF	OFF	OFF	OFF	OFF
Ton	10.000s	1.000s	1.000s	1.000s	1.000s
Toff	1.000s	1.000s	1.000s	1.000s	1.000s
Tdly	1.000s	1.000s	1.000s	1.000s	1.000s

Step 5 | Storage | Trig | Result

Battery discharge function

The T3EL15030xP can also provide insight into battery performance by analyzing the discharge characteristics of the DUT. The T3EL15030xP features three stop conditions for the discharge test: Voltage, capacity or time. The discharge process is immediately terminated if the stop conditions are met. This provides more control over the test termination and an extra layer of safety during critical tests. Throughout the test process the battery voltage, discharge current, discharge time and discharged capability is displayed clearly on the LCD panel.

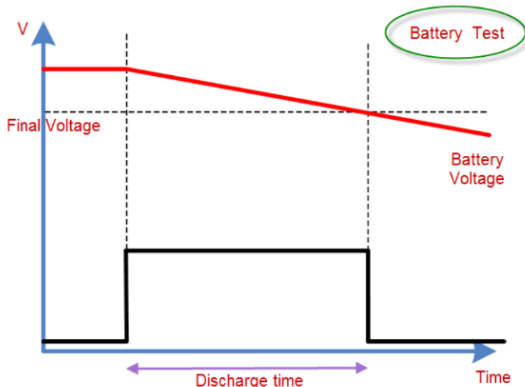

OCPT/OPPT Mode

Over-current protection (OCPT) mode prevents drawing too much current from the DUT. After the input voltage reaches the Von point, the DC load will start to draw a current from the source after a delay time. The current value will increase by a certain step size at regular intervals. Simultaneously, the DC load will compare the input voltage to the OCP voltage: If it is lower, then the present current value will be compared to see if it is in the current range you have set. Within the range, the OCP test will evaluate Pass or Fail. If it is outside of the set range, the DC load will to increase drawing current and compare the voltage again.

4.9395 V	0.9973 A
4.93 W	4.952 Ω

L_Range: 30A | V_Range: 150V | OCP_V: 1.00V | L_Step: 1.000A | Page 1/3

Overpower-protection (OPPT) mode: When the input voltage has reached the Von point, the load will draw power after a delay time. The power value will increase by a step size at regular intervals. Simultaneously, the DC load will judge whether the input voltage is lower than OPP voltage you have set, if it is, then the present current value will be compared to see if it is in the current range you have set. Within the range, the OPP test will Pass or Fail. If it is outside of the set power, the load will continue to increase the power draw within the cut-off current range and compare OPP voltage with the input.

CR-LED Mode

The T3EL15030xP includes a CR-LED mode specifically for LED driver testing. Basing on the traditional CR mode, CR-LED mode adds a diode break-over voltage setting. When the input voltage is above this set value, the DC load start to work. Thus, it can emulate the actual characteristics of an LED.

4.7505 V	0.8566 A
4.07 W	5.501 Ω

L_Range: 30A | V_Range: 150V | Io: 1.000A | Vo: 5.00V | Rco: 0.2000

Voltage Rise/Fall speed test

The electronic load is also equipped to directly measure voltage rise and fall times. It can calculate the time from one voltage to another without the need for additional measurement instrumentation. With an T3EL15030xP, you can save money and improve efficiency.



Waveform trend chart function

The electronic load includes a waveform display function and supports the following operations for the waveform: Pause, recording, and capturing the waveform. You can quickly observe the trends of parameter changes as they occur throughout the test.

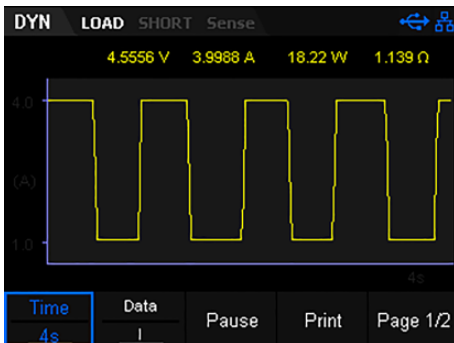

External analog control

The load allows the user to control current or voltage through external analog terminals (EXT PRG). Input a 0–10 V analog to adjust 0–100% rated voltage and current. It is very useful for those applications that need to change the input value with external signals.

Voltage threshold function

The T3EL15030xP can be set to turn on or off if the input voltage is at, above, or below a set value. By defining these thresholds, you control when the load is active. Which minimizes test time and increases safety.

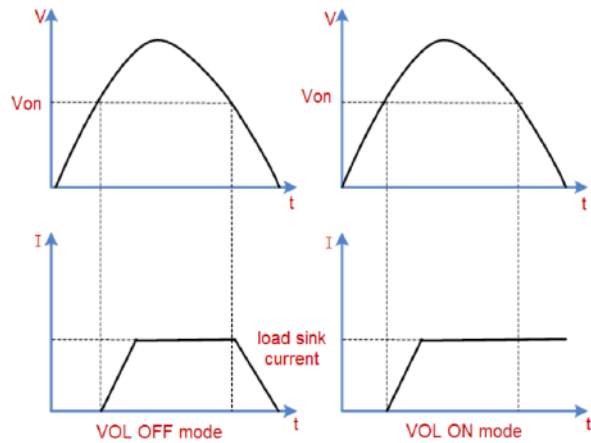

Save/Recall setting parameters

The load allows you to save different types of files to the internal and external memories. You can recall and read them when necessary.



Multiple protection modes

The T3EL15030xP series Programmable DC Electronic Load provides five protection types: OVP, OCP, OPP, OTP and LRV. When OVP/OCP/OPP/OTP/reverse voltage protection (LRV) occurs, the load will immediately turn off the input and stop sinking. Then, a prompt message is displayed.

SPECIFICATIONS

Unless otherwise noted, all specifications are guaranteed within the temperature range of 25 °C ± 5 °C with warm-up time of 30 minutes.

Model		T3EL150303P		T3EL150302P	
Input Rating (0 – 40 °C)	Input voltage	0 – 150 V		0 – 150 V	
	Input current	0 – 5 A	0 – 30 A	0 – 5 A	0 – 30 A
	Input power	300 W		200 W	
	Minimum Operating Voltage (DC)	0.15 V at 5 A	0.9 V at 30 A	0.15 V at 5 A	0.9 V at 30 A
CV Mode	Range	0 – 36 V	0 – 150 V	0 – 36 V	0 – 150 V
	Resolution	1 mV		1 mV	
	Accuracy	± (0.05 % + 0.025 % FS) 50 ppm/°C		± (0.05 % + 0.025 % FS) 50 ppm/°C	
CC Mode	Range	0 – 5 A	0 – 30 A	0 – 5 A	0 – 30 A
	Resolution	1 mA		1 mA	
	Accuracy ²⁾	± (0.1 % + 0.1 % FS) 100 ppm/°C		± (0.1 % + 0.1 % FS) 100 ppm/°C	
CR Mode ¹⁾	Range	0.03 Ω – 10 kΩ			
	Resolution	1 mA/Vsense			
	Accuracy	0.01 % + 0.0008 s ¹⁾			
CP Mode ³⁾	Range	300 W		200 W	
	Resolution	10 mW			
	Accuracy	0.1 % + 0.1 % FS			

Dynamic Model

CC Mode					
T1&T2	20 μs – 999 S/Res: 1 μS		20 μs – 999 S/Res: 1 μS		
Accuracy	20 μs – 200 ms/Acc: 5 μs, 200 ms – 999 s/Acc: 5 ms		20 μs – 200 ms/Acc: 5 μs, 200 ms – 999 s/Acc: 5 ms		
Current Slew Rate ⁴⁾	0.001 – 0.5 A/μs	0.001 – 2.5 A/μs	0.001 – 0.5 A/μs	0.001 – 2.5 A/μs	
Minimum Rise Time	≈10 μS	≈12 μS	≈10 μS	≈12 μS	

Measuring Range					
Readback Voltage	Range	0 – 36 V	0 – 150 V	0 – 36 V	0 – 150 V
	Resolution	1 mV		1 mV	
	Accuracy	± (0.05 % + 0.02 % FS) 20 ppm/°C		± (0.05 % + 0.02 % FS) 20 ppm/°C	
Readback Current	Range	0 – 5 A	0 – 30 A	0 – 5 A	0 – 30 A
	Resolution	1 mA		1 mA	
	Accuracy	± (0.05 % + 0.05 % FS) 50 ppm/°C		± (0.05 % + 0.05 % FS) 50 ppm/°C	
Readback Power	Range	300 W		200 W	
	Resolution	10 mW			
	Accuracy	± (0.1 % + 0.1 % FS)			
Readback Resistance	Range	0.03 Ω – 10 kΩ			
	Resolution	0.001 Ω			

Protection Range					
OPP	310 W		210 W		
OCP	5.1 A	31 A	5.1 A	31 A	
OVP	41 V	155 V	41 V	155 V	
OTP	95 °C		85 °C		
Battery Measurement	Battery Input: 0.5 – 150 V; Max Measurement: Capacity = 999 AH Resolution = 0.1 mA; Time Range = 1 s – 24 H				
Input Resistance	>200 kΩ				
Dimension	256 x 115 x 410 (W x H x D mm)				
Weight	5.8 kg				

¹⁾ Resistance Range: $(1/(1/R + (1/R) * 0.01 \% + 0.0008), 1/(1/R - (1/R) * 0.01 \% - 0.0008)$

²⁾ Current Slew rate > 0.2 A/μs

³⁾ The input voltage/current value should not be smaller than 10 % of the full scale.

⁴⁾ Current slew rate: rising slew rate for 10 % – 90 % of the current (0 – maximum current).

CR Mode ¹⁾				
I Range	V Range	R Range	Accuracy	Test Condition
5 A	36 V	0.03 Ω – 10 kΩ	0.01 % + 0.08 s (0.05 – 10 Ω) 0.01 % + 0.0008 s (10 – 10000 Ω) ¹⁾	The input voltage/current value should not be smaller than 10 % of the full scale
	150 V			
30 A	36 V			
	150 V			

¹⁾ Resistance Range: $(1/(1/R + (1/R) * 0.01 \% + 0.0008), 1/(1/R - (1/R) * 0.01 \% - 0.0008))$

Product information

	Product No
150 V/30 A 200 W Programmable DC Electronic Load	T3EL150302P
150 V/30 A 300 W Programmable DC Electronic Load	T3EL150303P

Standard Accessories

USB Cable -1

Quick Start -1

Calibration Certificate -1

Power cord -1

Warranty

Three-year warranty, excluding accessories.

ABOUT TELEDYNE TEST TOOLS



Company Profile

Teledyne LeCroy is a leading provider of oscilloscopes, protocol analyzers and related test and measurement solutions that enable companies across a wide range of industries to design and test electronic devices of all types. Since our founding in 1964, we have focused on creating products that improve productivity by helping engineers resolve design issues faster and more effectively. Oscilloscopes are tools used by designers and engineers to measure and analyze complex electronic signals in order to develop high-performance systems and to validate electronic designs in order to improve time to market.

The Teledyne Test Tools brand extends the Teledyne LeCroy product portfolio with a comprehensive range of test equipment solutions. This new range of products delivers a broad range of quality test solutions that enable engineers to rapidly validate product and design and reduce time-to-market. Designers, engineers and educators rely on Teledyne Test Tools solutions to meet their most challenging needs for testing, education and electronics validation.

Location and Facilities

Headquartered in Chestnut Ridge, New York, Teledyne Test Tools and Teledyne LeCroy has sales, service and development subsidiaries in the US and throughout Europe and Asia. Teledyne Test Tools and Teledyne LeCroy products are employed across a wide variety of industries, including semiconductor, computer, consumer electronics, education, military/aerospace, automotive/industrial, and telecommunications.

Distributed by:

Teledyne LeCroy (US Headquarters)

700 Chestnut Ridge Road
Chestnut Ridge, NY. USA 10977-6499

Phone: 800-553-2769 or 845-425-2000
Fax Sales: 845-578-5985
Phone Support: 1-800-553-2769
Email Sales: contact.corp@teledynelecroy.com
Email Support: support@teledynelecroy.com
Web Site: <http://teledynelecroy.com/>

Teledyne LeCroy (European Headquarters)

Teledyne GmbH

Im Breitspiel 11c
D-69126 Heidelberg, Germany

Phone: +49 6221 82700
Fax: +49 6221 834655
Phone Service: +49 6221 8270 85
Phone Support: +49 6221 8270 28
Email Sales: contact.gmbh@teledynelecroy.com
Email Service: service.gmbh@teledynelecroy.com
Email Support: tlc.t3.appsupport.eu@teledyne.com
Web Site: <http://teledynelecroy.com/germany>

World wide support contacts can be found at:
<https://teledynelecroy.com/support/contact/#>

teledynelecroy.com



© 2020 Teledyne Test Tools is a brand and trademark of Teledyne LeCroy Inc. All rights reserved. Specifications, prices, availability and delivery subject to change without notice. Product brand or brand names are trademarks or requested trademarks of their respective holders.

T3 stands for Teledyne Test Tools.

04dec20