

THIS DRAWING CONTAINS INFORMATION PROPRIETARY TO RF INDUSTRIES.
 ANY UNAUTHORIZED USE OF THIS DRAWING IS EXPRESSLY PROHIBITED
 WITHOUT WRITTEN PERMISSION FROM RF INDUSTRIES.
 ANY VIOLATION IS PUNISHABLE UNDER U.S. COPYRIGHT LAWS.

ALL DIMENSIONS ARE REFERENCE ONLY

PART NO.

RFN-1002-1N

REV	DESCRIPTION	DWN	DATE	APPROVED
A	ENGINEERING RELEASE	CZS	9/2/99	R. RICE
B	CHANGE FORMAT, SPECS & DWG # 9239	GGG	7/15/02	JDMc

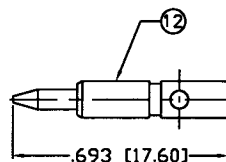
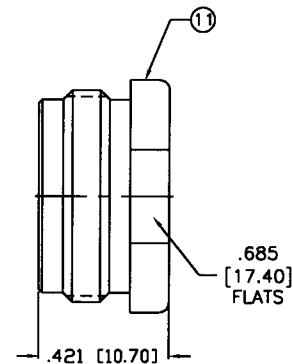
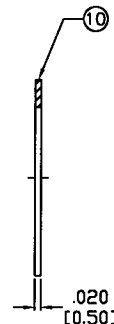
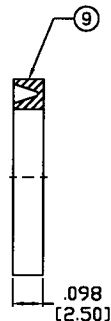
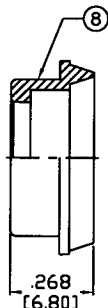
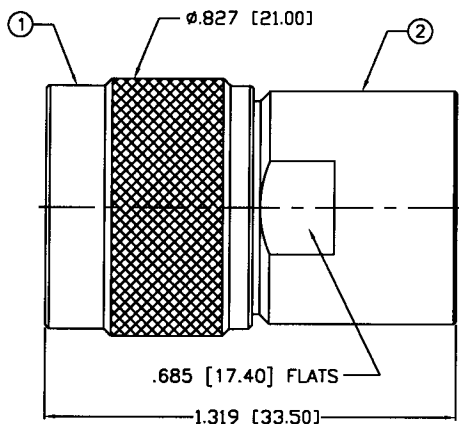

RECOMMENDED
CRIMP DIE: .100"

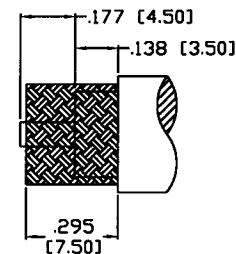

RECOMMENDED
STRIPPING DIMENSIONS

SPECIFICATIONS:

IMPEDANCE: 50 Ohms
 FREQUENCY RANGE: 0-11 GHz
 INSERTION LOSS: .06 dB Max. X \sqrt{f} GHz
 WORKING VOLTAGE: 1k V rms @ sea level
 TEMPERATURE RANGE: -65°C TO 85°C
 INSULATION RESISTANCE: 5k M Ohms min.
 FOR RG-8, 8A, 213/U, BELDEN 8237, 8267, 9251 & 9880

1	SHELL	1	BRASS	NICKEL, 100 μ "
2	BODY	1	BRASS	NICKEL, 100 μ "
3	GROUND RING	1	BRASS	NICKEL, 100 μ "
4	GASKET	1	SILICONE	---
5	RETAINING RING	1	SST	---
6	INSULATOR	1	PTFE	---
7	WASHER	1	BRASS	NICKEL, 100 μ "
8	CLAMP	1	BRASS	NICKEL, 100 μ "
9	GASKET	1	SILICONE	---
10	WASHER	1	BRASS	NICKEL, 100 μ "
11	NUT	1	BRASS	NICKEL, 100 μ "
12	PIN	1	BRASS	GOLD, 3 μ "
13				
14				
#	DESCRIPTION	QTY	MATRL	FINISH

008974

UNLESS OTHERWISE SPECIFIED:

1. REMOVE ALL BURRS
2. BREAK ALL CORNERS & EDGES .005 R. MAX.
3. CHAMFER 1ST & LAST THREADS 45°
4. SURFACE ROUGHNESS 63 FINISH MIL-STD-10
5. DIAMETERS ON COMMON CENTERS TO BE CONCENTRIC WITHIN .002 T.I.R.
6. ALL DIMENSIONS ARE AFTER PLATING.

DIMENSIONS ARE IN INCHES
AND [MILLIMETERS]

UNLESS OTHERWISE NOTED
TOLERANCES ARE:

DECIMALS	DIAMETER
.xxx±.003 [.08]	.xxx±.001 [.03]
.xx±.005 [.13]	.xx±.003 [.08]

DRAWN	G. GALLEGOS	7/15/02
CHECKED	<i>[Signature]</i>	7-15-02
ORJ DRAWN	C. ZUNIGA	9/2/99
APPROVALS	DATE	

RF connectors
DIVISION OF RF INDUSTRIES, LTD.

7610 MIRAMAR RD
 SAN DIEGO, CA 92126
 (858) 549-6340
 (858) 549-6345 FAX

N PLUG, CLAMP

SIZE	CABLE GROUP	DWG NO.	REV
A	E	RFN-1002-1N	B
SCALE:	NTS	CAD FILE	OUTLINE
			SHEET 1 OF 1