

Shock-Safe Fuseholder, 5 x 20 mm, Fingergrip, horizontal or vertical



250 VAC/DC · 1.3W/10A10A (UL/CSA)

See below:

[Approvals and Compliances](#)

### Description

- Screw type fuse carrier
- PCB mounting horizontal or vertical

### Weblinks

[pdf data sheet](#), [html datasheet](#), [General Product Information](#), [Packaging details](#), [Distributor-Stock-Check](#), [Detailed request for product](#), [Microsite](#)

### Technical Data

Fuse-Link	5 x 20 mm
Mounting	PCB
Terminal	Solder THT
Rated Voltage	250 VAC/DC
Rated current	10 A (UL/CSA)
Rated Power Acceptance IEC	1.3 W / 10 A @ Ta 23 °C
Degree of Protection	IP 40
Protection Class	Suitable for appliances with protection class I or II acc. to IEC 61140
Admissible Ambient Air Temp.	-40 °C to 85 °C
Climatic Category	40/085/56 acc. to IEC 60068-1
Material: Socket	Thermoset, black
Material: Cap	Thermoplastic, black
Unit Weight	6 g
Storage Conditions	0 °C to 60 °C, max. 70% r.h.
Product Marking	 , Type, Rated Voltage, Rated current, Certification marks

Soldering Methods	Wave <a href="#">Soldering Profile</a>
Contact Resistance	< mΩ at 100 mA
Resistance to Vibration	acc. to NF C 20-706 / IEC 60068-2-6, test Fc
Shocks	acc. to NF C 20-706 / IEC 60068-2-27
Bumps	acc. to NF C 20-729 / IEC 60068-2-29

### Approvals and Compliances



Detailed information on product approvals, code requirements, usage instructions and detailed test conditions can be looked up in [Details about Approvals](#)

SCHURTER products are designed for use in industrial environments. They have approvals from independent testing bodies according to national and international standards. Products with specific characteristics and requirements such as required in the automotive sector according to IATF 16949, medical technology according to ISO 13485 or in the aerospace industry can be offered exclusively with customer-specific, individual agreements by SCHURTER.

### Approvals

The approval mark is used by the testing authorities to certify compliance with the safety requirements placed on electronic products.

Approval Reference Type: 231409

Approval Logo	Certificates	Certification Body	Description
	<a href="#">UL Approvals</a>	UL	UL File Number: E41738
	<a href="#">CSA Approvals</a>	CSA	CSA Certification Record: LR 23151
GAM T1 <b>NNO</b>			

**Product standards**

Product standards that are referenced

Organization	Design	Standard	Description
	Designed according to	UL 4248-1	Fuseholder general requirements
	Designed according to	CSA C22.2 no. 4248.1	Fuseholder general requirements





**Application standards**

Application standards where the product can be used

Organization	Design	Standard	Description
	Designed for applications acc.	IEC/UL 60950	IEC 60950-1 includes the basic requirements for the safety of information technology equipment.

**Compliances**

The product complies with following Guide Lines

Identification	Details	Initiator	Description
		SCHURTER AG	The CE marking declares that the product complies with the applicable requirements laid down in the harmonisation of Community legislation on its affixing in accordance with EU Regulation 765/2008.
	RoHS	SCHURTER AG	Directive RoHS 2011/65/EU, Amendment (EU) 2015/836
	China RoHS	SCHURTER AG	The law SJ / T 11363-2006 (China RoHS) has been in force since 1 March 2007. It is similar to the EU directive RoHS.
	REACH	SCHURTER AG	On 1 June 2007, Regulation (EC) No 1907/2006 on the Registration, Evaluation, Authorization and Restriction of Chemicals 1 (abbreviated as "REACH") entered into force.

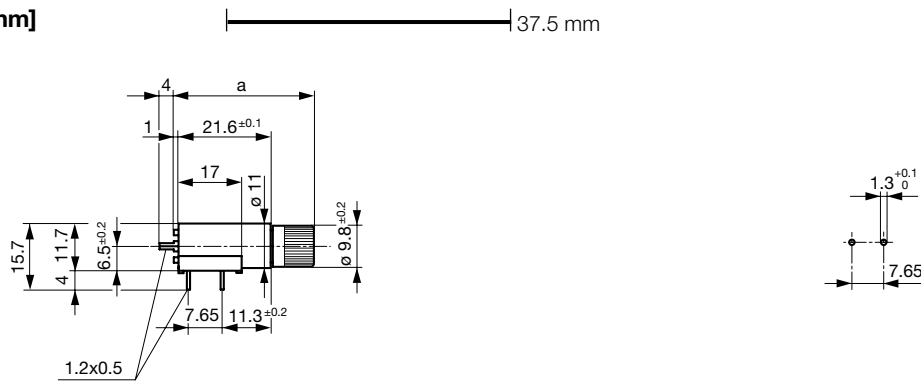

**Dimension [mm]**



a = 33.5 Variants 7091.4210, 7091.4240 and 7091.4270  
 a = 38.5 Variant 7091.4400

Drilling diagram

**All Variants**

Holder	Cap	Mounting	Degree of Protection	  GAM T1 NNO	Reference	Order Number
●	Fingergrasp	horizontal / vertical	IP40	● ● ● ●	231409	7091.4210
●	Fingergrasp	vertical	IP40	●	231409L	7091.4240
●	Fingergrasp	horizontal	IP40	●	231409F	7091.4270
●	Fingergrasp	vertical	IP40		231632NL	7091.4400

Availability for all products can be searched real-time: <https://www.schurter.com/en/Stock-Check/Stock-Check-SCHURTER>

**Packaging Unit** Bulk (10 pcs.)