

SPECIFICATION SHEET

SPECIFICATION SHEET NO.	Q0125- YG27M00000S420
DATE	Jan. 25, 2023
REVISION	A0
DESCRIPTION	MHz Plastic SMD Crystals, L8.0*W3.8*H2.5mm, 4 Pads, CCMD series 27.00000MHz, Tolerance +/-20ppm, Load Capacitor 20pF, Frequency stability +/-30ppm @Operating Temp. Range -40°C ~+85°C, ESR 60 ohm Max, Reflow Profile Condition 260 °C Max. Tape/Reel, 3000pcs/Reel RoHS/RoHS III compliant, RoHS Annex III lead Exemption (exempt per RoHS EU 2015/863)
CUSTOMER	
CUSTOMER PART NUMBER	
CROSS REF. PART NUMBER	
ORIGINAL PART NUMBER	TGS CCMD 27M0A20-20-30-40-60TLH
PART CODE	YG27M00000S420

VENDOR APPROVE

Issued/Checked/Approved



DATE: Jan. 25, 2023

CUSTOMER APPROVE

DATE:

1/25/2023

MHZ PLASTIC SMD CRYSTALS 8038 TYPE CCMD SERIES

MAIN FEATURE

- SMD Package, 8038 Type, L8.0*W3.8*H2.5mm, 4 Pads
- Low cost and short lead time
- Industry standard
- Reflow Profile Condition 260 °C Max.
- Cross more competitors part
- RoHS/RoHS III compliant, RoHS Annex III lead Exemption (exempt per RoHS EU 2015/863)



APPLICATION

- Clock source for Portable
- Microcomputer & Automotive Equipment with Low power consumption

PART CODE GUIDE

RFQ

[Request For Quotation](#)

YG	27M00000	S	420
1	2	3	4

- 1) YG: Part family Code for MHz Plastic SMD Crystals, L8.0*W3.8*H2.5mm, 4 Pads, CCMD series
- 2) 27M00000: Frequency range code for 27.000MHz
- 3) S: SMD type, Package Tape/Reel, 3000pcs/Reel
- 4) 420: Specification code for original part No.: **TGS CCMD 27M0A20-20-30-40-60TLH**

MHZ PLASTIC SMD CRYSTALS 8038 TYPE CCMD SERIES

DIMENSION (Unit: Inch/mm)

Image for reference



CCMD

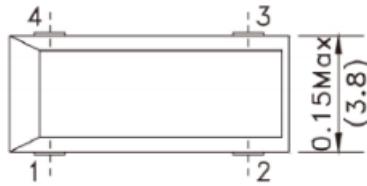

Marking

Frequency Range

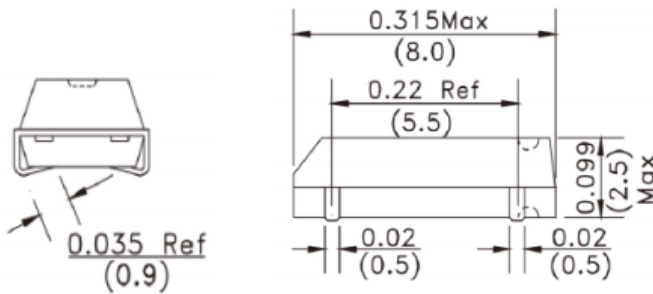
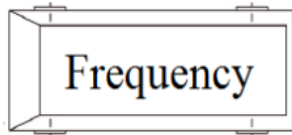

Note:

- Do not connect pad 2 and Pad 3 to external devices.
- Metal inside may be exposed on the top or bottom of plastic case
- It isn't Quality problem. This will not affect any quality, reliability and electrical specification when used

Recommend Pad Layout

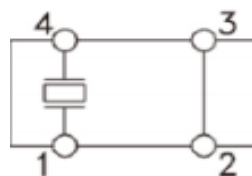
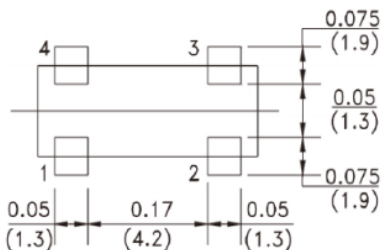

Pin Function

- #1 Crystal
- #2 Ground
- #3 Ground
- #4 Crystal

MHZ PLASTIC SMD CRYSTALS 8038 TYPE CCMD SERIES
ELECTRICAL PARAMETERS

Parameter	Part No. Symbol	Units	Value			Condition
			Min.	Typical	Max.	
Original Manufacturer	TGS	TGS Crystals				
Holder Type	CCMD	MHz SMD Crystal, Plastic case, L8.0*W3.8*H2.5mm				
Frequency Range	27M0	MHz	27.0000			
Mode of Oscillation	A	AT Fundamental				
Frequency Tolerance	20	ppm	-20		+20	@25°C
Load Capacitance	-20	pF	20			
Stability over Operation Temperature	-30	ppm	-30		+30	
Operation Temperature	-40	°C	-40		+85	
Storage Temperature		°C	-55		+125	
Equivalent Series Resistance (ESR)	-60	Ω			60	
Drive Level		μW			100	
Shunt Capacitance (C0)		pF	0		7.0	
Motional Capacitance (C1)		fF	N/A			
DLD2		Ω	N/A			
FLD2		ppm	N/A			
RDL2		Ω	N/A			
SPDB		dB	N/A			
Aging		ppm/year			±5	@1 st year
Insulation Resistance		MΩ	500			@100VDC ± 15Vdc
Others	Package	T	Tape/Reel			
	RoHS Status	LH	RoHS III compliant, RoHS Annex III lead Exemption (exempt per RoHS EU 2015/863)			
	Add Value		N/A			
	Code *		Internal Control or N/A			

Note: 1) Original Part Number: **TGS CCMD 27M0A20-20-30-40-60TLH**

2) * Internal Control Code- 2 letter or digits; Blank: N/A

MHZ PLASTIC SMD CRYSTALS 8038 TYPE CCMD SERIES

TEST STANDARD

General Electrical Characteristics And Visual testing

1. LOT CLASSIFICATION : If The Quantity Is 1000 PCS Or More, 1000 PCS Is One Lot
 2. Sampling Test Method : Mil-std-105e G-ii
 3. Test Level
 - A) High Level Defect : AQL 0.065% [200 Pcs]
 - B) Medium Level Defect : AQL 0.25% [50 Pcs]
 - C) Low Level Defect : AQL 0.4% [32 Pcs]
 4. Defect Classification:
 - A) High Level: @No Frequency; @Mixing; @Leak Defect
 - B) Medium Level - Electrical Characteristic Defect :
 - @Frequency; @Oscillation; @Electrical Current; @Other Electrical Characteristics Defect
 - C) Visual : @Marking; @Welding; @Leads ; @Other Visual Defect
- Testing Method And Its Standard Can Be Modified Depending On The Customer's Request

EQUIVALENT CIRCUITS

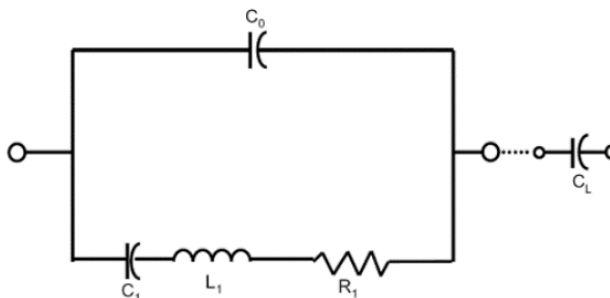
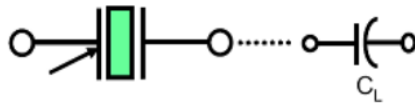

Symbol for crystal unit

MHZ PLASTIC SMD CRYSTALS 8038 TYPE CCMD SERIES

CHARACTERISTICS

Units and values indicated with { } in this specification are the former units and the specified values.

Standard Atmospheric Conditions:

Unless otherwise specified the standard range of atmospheric conditions for making measurements and tests is as follows:

Ambient temperature: 15°C to 35°C;

Relative humidity : 25% to 85%;

Air pressure: 86 to 106 k Pa

If there is any doubt about the results measurements shall be made within the following limits:

Ambient temperature : 25±1°C;

Relative humidity : 63% to 67% ;

Air pressure : 86 to 106 k Pa

Operating Temperature Range:

The operating temperature range is the range of ambient temperatures at which the quartz crystal oscillator can be stored without damage. Conditions are as specified elsewhere on these specifications.

Operating temperature range: -40°C to +85°C

Storage Temperature Range:

The storage temperature range is the range of ambient temperatures at which the quartz crystal oscillator can be stored without damage. Conditions are as specified elsewhere on these specifications.

Storage temperature range: -55°C to +125°C

MHZ PLASTIC SMD CRYSTALS 8038 TYPE CCMD SERIES

CAUTION

In Order To Maintain Quality. Without Change In Characteristics Of The crystal Units. Please Follow Below Recommendation

Shock

All Crystal Units Have A Thin Crystal Blanks Within If It Is Dropped Above The Recommended Dropping Height (500mm) The Specific Characteristics And Appearance Can Be Changed Please Pay Special Attention To External Shock

Environmental

- 1) Crystal Units' Frequency Can Be Changed Due To Surrounding Temperature If It Is Stored Next To A High Temperature Heter (Above+85'c) Or Below 40'c.And A Strong Light Source For Long Period Of Time. The Electrical Characteristics Can Be Changed It Is Suggested That These Environment Be Avoided
- 2) If The Unit Is Placed In A Humid Environment. Lead Terminal Can Be Damaged: Therefore. Do Not Store The Crystal Units In A Humid Environment
- 3) Crystal unit Has Vibrating Characteristics If It Is Placed Where Vibration Exists The Operating Characteristics Can Be Altered; Therefore This Environment Should Be Avoided

Leads

- 1) After Soldering Crystal Units Into A PCB Impacting The Unit From The top, bottom Left Or Right Side Of The Unit Can Shatter The Glass Portion Of The Base Aendering The Unit Useless

Assembly Method

- 1) Correct Ultrasonic Frequency For Cleaning Should Be Less Than 20khz
- 2) SOLDERING SHOULD BE BONE USING IEC 61760-1 OR Pb-free Products

Storage

5.5.1 If The Crystal Units Are Stored In Humid Or Salty Environment Appearance Can Be Changed And Solderability Can Deteriorate; Therefore avoid Storing In Such Environment Do Not Store The Crystal Unit More Than 3 Months

MHZ PLASTIC SMD CRYSTALS 8038 TYPE CCMD SERIES
RELIABILITY (MECHANICAL AND ENVIRONMENTAL ENDURANCE)

TEST ITEMS	TEST METHOD AND CONDITIONS	REQUIREMENTS
Vibration	(1) Vibration Frequency: 10 To 55hz (2) Vibration Amplitude: 1.5mm (3) Cycle Time: 1~2min(10-55-10hz) (4) Direction: X.Y.Z (5) Duration: 2h/Each Direction (6) G-force: ≥5g	Frequency Change: ±10ppm Max. Resistance Change: ± 15% RRMax
SHOCK	3 Times Free Drop From 75cm Height To Hard Wooden Board Of Thickness More Than 30mm.	Frequency Change: ±10ppm Max. Resistance Change: ± 15% RRMax.
LEAKAGE	Put Crystal Units Into A Hermetic Container And Helium For 0.5-0.6. MPA and Keep It For 1h;check The Leakage By A Helium Leak Detector.	Leakage:1x10 ⁻⁸ mbar.L/S Max.
SOLDERABILITY	(1) Dip The Leads Into Flu X (ROJIN Methanol) For 3~5s. (2) Dip The Leads Into 245±5°C 99% Sn Dipping Solution For 5s.	The Dipped Part Of The Leads Should Have 95% SN Coating.
SOLDERING HEAT RESISTANCE TEST	(1) Perform Electrical Characteristics Test Before Starting This Procedure. (2) Dip The Leads Into Flux(rojin Methanol) 5±0.5s. (3) Dip The Leads Into 260±5°C 99% Sn Dipping Solution For 5s. (4) Take The Unit Out ,Store At Room Temper For 30s Then Measure The Electrical Characteristics.	Should Pass Sealing And Visual Test. Frequency Change: ±10ppm Max.
LEAK TEST	Use Helium Leak Detector. Bombing Pressure:5kg/Cm ² Bombing Time: 2 Hours Leak Should Be Less Than 1e-8 Atm. Cc/Sec.	Gas Or Air Should Not Be Detected.

MHZ PLASTIC SMD CRYSTALS 8038 TYPE CCMD SERIES

RELIABILITY(MECHANICAL AND ENVIRONMENTAL ENDURANCE)

Test Items	Test Method And Conditions	Requirements
HIGH TEMPERATURE ENDURANCE	The Crystal Units Shall Be Put In Somewhere For 500 Hours At Temperature Of 125°C ±5°C ,Then Keep It For 1 To 2 Hours Under Room Temperature.	Frequency Change: ±10ppm Max. Resistance Change: ± 15%RRmax.
LOW TEMPERATURE ENDURANCE	The Crystal Units Shall Be Put In Somewhere For 500 Hours At Temperature Of -40°C ,Then Keep It For 1 To 2 Hours Under Room.	Frequency Change: ±10ppm Max. Resistance Change: ± 15% RRMax
HUMIDITY ENDURANCE	Somewhere At 40°C ±5°C In Relative Humidity Of 90%~95% For 72 Hours, Then Keep It For One Or Two Hours Under Room Temperature	Frequency Change: ±10ppm Max. Resistance Change: ± 15% RRMax
TEMPERATURE CYCLE	Temperature Shift From Low(-40°C) To High(100°C,keep 30 Minutes),satisfy High(100°C) To Low(-40°C ,Keep 30 Minutes),then Go Up To Room Temperature For 10 Cycles.	Frequency Change: ±10ppm Max. Resistance Change: ± 15% RRMax
LEAD TENSILTY	(1) Fix The Unit. (2) Apply 2lb Of Weight Axis To The Leads. (3) Time:5s	Should Pass Sealing And Visual Test.
LEAD BENDING	(1) Attach 1lb Of Weight To Each Of The Leads. (2) Bending Angle:90°(from The Nomal Position To 45°oppostte Direction) (3) Bending Time:3s(each Direction) Number Of Bending:2times (4) Number Of Bending:2times	Should Pass Sealing And Visual Test.
MARKING ERASE	Submerge The Unit Into Ipa [isopropyl Alcohol] Solution For 10minutes And Brush The Marking 10 Times With A Tooth Brush.	Marking Should Not Be Erased.

MHZ PLASTIC SMD CRYSTALS 8038 TYPE CCMD SERIES
SUGGESTED REFLOW PROFILE (For Reference Only)

Total time: 200 Sec. Max. Solder melting point: 220°C



Profile Feature		Pb-Free Assembly
Average Ramp-up Rate (Ts Max to Tp)		3°C/second Max
Preheat	Temperature Min (Ts Min.)	125°C
	Temperature Max (Ts Max.)	200°C
	Time (ts Min. to ts Max.)	60 ~ 180 seconds
Time maintained above	Temperature (Tl)	217°C
	Time (tl)	60 ~ 150 seconds
Peak/Classification Temperature (Tp)		260 °C
Time within 5°C of actual Peak Temperature (tp)		20 ~ 40 seconds
Ramp-down rate		6 °C /Second Max.
Time 25 °C to Peak Temperature		8 minutes Max.
Suggest reflow times		3 Times Max.

MHZ PLASTIC SMD CRYSTALS 8038 TYPE CCMD SERIES

TAPE/REEL (Unit: mm)

All Devices are packed in accordance with EIA standard RS-481-2 and specifications, 3000pcs/Reel

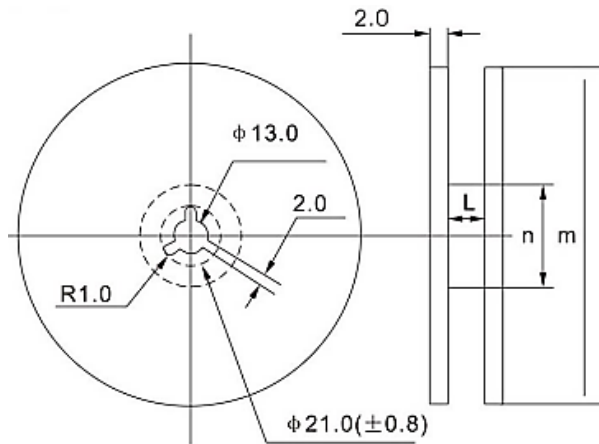
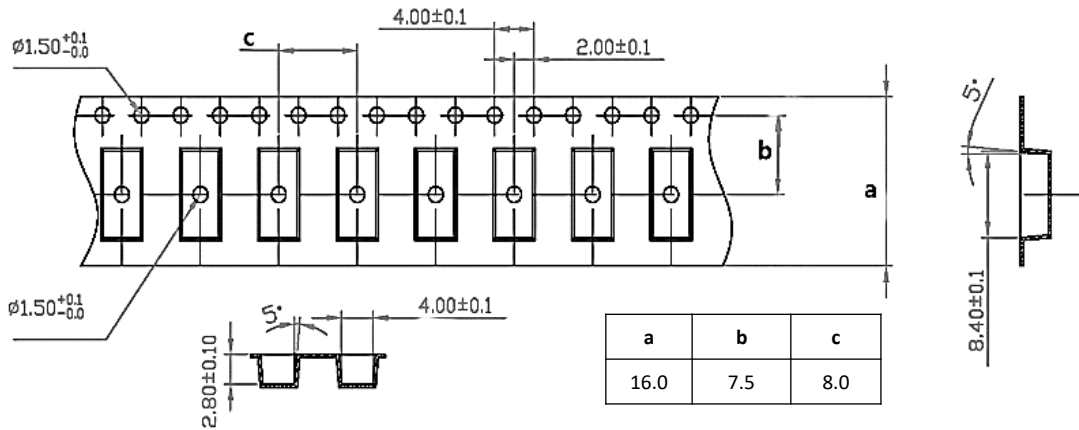

Pieces per reel	ϕm	ϕn	L	Carrier tape size
3000/reel	330 ± 3	80min	17.5	16

DISCLAIMER

NextGen Components, Inc. reserves the right to make changes to the product(s) and or information contained herein without notice. No liability is assumed as a result of their use or application. No rights under any patent accompany the sale of any such product(s) or information