



User Manual

SOM-5890

ADVANTECH

Enabling an Intelligent Planet

Copyright

The documentation and the software included with this product are copyrighted 2011 by Advantech Co., Ltd. All rights are reserved. Advantech Co., Ltd. reserves the right to make improvements in the products described in this manual at any time without notice. No part of this manual may be reproduced, copied, translated or transmitted in any form or by any means without the prior written permission of Advantech Co., Ltd. Information provided in this manual is intended to be accurate and reliable. However, Advantech Co., Ltd. assumes no responsibility for its use, nor for any infringements of the rights of third parties, which may result from its use.

Acknowledgements

Intel and Pentium are trademarks of Intel Corporation.

Microsoft Windows and MS-DOS are registered trademarks of Microsoft Corp.

All other product names or trademarks are properties of their respective owners.

Product Warranty (2 years)

Advantech warrants to you, the original purchaser, that each of its products will be free from defects in materials and workmanship for two years from the date of purchase.

This warranty does not apply to any products which have been repaired or altered by persons other than repair personnel authorized by Advantech, or which have been subject to misuse, abuse, accident or improper installation. Advantech assumes no liability under the terms of this warranty as a consequence of such events.

Because of Advantech's high quality-control standards and rigorous testing, most of our customers never need to use our repair service. If an Advantech product is defective, it will be repaired or replaced at no charge during the warranty period. For out-of-warranty repairs, you will be billed according to the cost of replacement materials, service time and freight. Please consult your dealer for more details.

If you think you have a defective product, follow these steps:

1. Collect all the information about the problem encountered. (For example, CPU speed, Advantech products used, other hardware and software used, etc.) Note anything abnormal and list any onscreen messages you get when the problem occurs.
2. Call your dealer and describe the problem. Please have your manual, product, and any helpful information readily available.
3. If your product is diagnosed as defective, obtain an RMA (return merchandise authorization) number from your dealer. This allows us to process your return more quickly.
4. Carefully pack the defective product, a fully-completed Repair and Replacement Order Card and a photocopy proof of purchase date (such as your sales receipt) in a shippable container. A product returned without proof of the purchase date is not eligible for warranty service.
5. Write the RMA number visibly on the outside of the package and ship it prepaid to your dealer.

Declaration of Conformity

CE

This product has passed the CE test for environmental specifications when shielded cables are used for external wiring. We recommend the use of shielded cables. This kind of cable is available from Advantech. Please contact your local supplier for ordering information.

CE

This product has passed the CE test for environmental specifications. Test conditions for passing included the equipment being operated within an industrial enclosure. In order to protect the product from being damaged by ESD (Electrostatic Discharge) and EMI leakage, we strongly recommend the use of CE-compliant industrial enclosure products.

FCC Class A

Note: This equipment has been tested and found to comply with the limits for a Class A digital device, pursuant to part 15 of the FCC Rules. These limits are designed to provide reasonable protection against harmful interference when the equipment is operated in a commercial environment. This equipment generates, uses, and can radiate radio frequency energy and, if not installed and used in accordance with the instruction manual, may cause harmful interference to radio communications. Operation of this equipment in a residential area is likely to cause harmful interference in which case the user will be required to correct the interference at his own expense.

FCC Class B

Note: This equipment has been tested and found to comply with the limits for a Class B digital device, pursuant to part 15 of the FCC Rules. These limits are designed to provide reasonable protection against harmful interference in a residential installation. This equipment generates, uses and can radiate radio frequency energy and, if not installed and used in accordance with the instructions, may cause harmful interference to radio communications. However, there is no guarantee that interference will not occur in a particular installation. If this equipment does cause harmful interference to radio or television reception, which can be determined by turning the equipment off and on, the user is encouraged to try to correct the interference by one or more of the following measures:

- Reorient or relocate the receiving antenna.
- Increase the separation between the equipment and receiver.
- Connect the equipment into an outlet on a circuit different from that to which the receiver is connected.
- Consult the dealer or an experienced radio/TV technician for help.

Technical Support and Assistance

1. Visit the Advantech website at <http://support.advantech.com> where you can find the latest information about the product.
2. Contact your distributor, sales representative, or Advantech's customer service center for technical support if you need additional assistance. Please have the following information ready before you call:
 - Product name and serial number
 - Description of your peripheral attachments
 - Description of your software (operating system, version, application software, etc.)
 - A complete description of the problem
 - The exact wording of any error messages

Warnings, Cautions and Notes

Warning! *Warnings indicate conditions, which if not observed, can cause personal injury!*



Caution! *Cautions are included to help you avoid damaging hardware or losing data. e.g.*



There is a danger of a new battery exploding if it is incorrectly installed. Do not attempt to recharge, force open, or heat the battery. Replace the battery only with the same or equivalent type recommended by the manufacturer. Discard used batteries according to the manufacturer's instructions.

Note! *Notes provide optional additional information.*



Document Feedback

To assist us in making improvements to this manual, we would welcome comments and constructive criticism. Please send all such - in writing to: support@advantech.com

Packing List

Before setting up the system, check that the items listed below are included and in good condition. If any item does not accord with the table, please contact your dealer immediately.

- 1 x SOM-5890 Module
- 1 x Heatspreader 125*95*11mm

Safety Instructions

1. Read these safety instructions carefully.
2. Keep this User Manual for later reference.
3. Disconnect this equipment from any AC outlet before cleaning. Use a damp cloth. Do not use liquid or spray detergents for cleaning.
4. For plug-in equipment, the power outlet socket must be located near the equipment and must be easily accessible.
5. Keep this equipment away from humidity.
6. Put this equipment on a reliable surface during installation. Dropping it or letting it fall may cause damage.
7. The openings on the enclosure are for air convection. Protect the equipment from overheating. **DO NOT COVER THE OPENINGS.**
8. Make sure the voltage of the power source is correct before connecting the equipment to the power outlet.
9. Position the power cord so that people cannot step on it. Do not place anything over the power cord.
10. All cautions and warnings on the equipment should be noted.
11. If the equipment is not used for a long time, disconnect it from the power source to avoid damage by transient overvoltage.
12. Never pour any liquid into an opening. This may cause fire or electrical shock.
13. Never open the equipment. For safety reasons, the equipment should be opened only by qualified service personnel.
14. If one of the following situations arises, get the equipment checked by service personnel:
 - The power cord or plug is damaged.
 - Liquid has penetrated into the equipment.
 - The equipment has been exposed to moisture.
 - The equipment does not work well, or you cannot get it to work according to the user's manual.
 - The equipment has been dropped and damaged.
 - The equipment has obvious signs of breakage.
15. **DO NOT LEAVE THIS EQUIPMENT IN AN ENVIRONMENT WHERE THE STORAGE TEMPERATURE MAY GO BELOW -20° C (-4° F) OR ABOVE 60° C (140° F). THIS COULD DAMAGE THE EQUIPMENT. THE EQUIPMENT SHOULD BE IN A CONTROLLED ENVIRONMENT.**
16. **CAUTION: DANGER OF EXPLOSION IF BATTERY IS INCORRECTLY REPLACED. REPLACE ONLY WITH THE SAME OR EQUIVALENT TYPE RECOMMENDED BY THE MANUFACTURER, DISCARD USED BATTERIES ACCORDING TO THE MANUFACTURER'S INSTRUCTIONS.**

The sound pressure level at the operator's position according to IEC 704-1:1982 is no more than 70 dB (A).

DISCLAIMER: This set of instructions is given according to IEC 704-1. Advantech disclaims all responsibility for the accuracy of any statements contained herein.

Safety Precaution - Static Electricity

Follow these simple precautions to protect yourself from harm and the products from damage.

- To avoid electrical shock, always disconnect the power from your PC chassis before you work on it. Don't touch any components on the CPU card or other cards while the PC is on.
- Disconnect power before making any configuration changes. The sudden rush of power as you connect a jumper or install a card may damage sensitive electronic components.

Contents

Chapter 1	General Information	1
1.1	Introduction	2
1.2	Specifications	2
1.2.1	Standard System On Module functions	2
1.2.2	Display Interface	3
1.2.3	Audio function	3
1.2.4	Ethernet	3
1.2.5	iManager	3
1.2.6	Mechanical and environmental	3
Chapter 2	Mechanical Information	5
2.1	Connectors	6
2.1.1	Board Connector	6
2.1.2	Connector List	6
2.2	Mechanical	7
2.2.1	Jumper and Connector Location	7
	Figure 2.1 Board Layout (component side)	7
	Figure 2.2 Board Layout (Solder side)	7
2.2.2	Board Dimension	8
	Figure 2.3 Board Dimension (Component side)	8
	Figure 2.4 Board Dimension (Solder side)	8
Chapter 3	BIOS Setup	9
3.1	BIOS Setup	10
	Figure 3.1 Setup program initial screen	10
3.2	Entering Setup	10
3.3	Main Setup	11
	Figure 3.2 Main setup screen	11
3.3.1	System time / System date	11
3.4	Advanced BIOS Features Setup	12
	Figure 3.3 Advanced BIOS features setup screen	12
3.4.1	ACPI Settings	13
	Figure 3.4 ACPI Setting	13
3.4.2	TPM Configuration	14
	Figure 3.5 TPM Configuration	14
3.4.3	CPU Configuration	14
	Figure 3.6 CPU Configuration	14
3.4.4	SATA Configuration	15
	Figure 3.7 SATA Configuration	15
3.4.5	Intel TXT(LT) Configuration	16
	Figure 3.8 Intel TXT(LT) Configuration	16
3.4.6	PCH-FW Configuration	17
	Figure 3.9 PCH-FW Configuration	17
3.4.7	AMT Configuration	17
	Figure 3.10 AMT Configuration	17
3.4.8	USB Configuration	19
	Figure 3.11 USB Configuration	19
3.4.9	Embedded Controller Configuration	20
	Figure 3.12 Embedded Controller Configuration	20
3.4.10	Super IO Configuration	21
	Figure 3.13 Super IO Configuration	21

3.4.11	Serial Port Console Redirection.....	22
	Figure 3.14Serial Port Console Redirection	22
3.4.12	Switchable Graphics	23
	Figure 3.15Switchable Graphics.....	23
3.4.13	Sandybridge DTS Configuration	23
	Figure 3.16Sandybridge DTS Configuration.....	23
3.4.14	Sandybridge PPM Configuration	24
	Figure 3.17Sandybridge PPM Configuration	24
3.5	Chipset.....	25
	Figure 3.18Chipset Setup.....	25
3.5.1	System Agent (SA) Configuration.....	25
	Figure 3.19System Agent (SA) Configuration	25
	Figure 3.20Intel IGFX Configuration.....	26
	Figure 3.21LCD Control.....	27
	Figure 3.22NB PCIe Configuration	28
3.5.2	PCH-IO Configuration.....	29
	Figure 3.23PCH-IO Configuration	29
	Figure 3.24USB Configuration.....	30
	Figure 3.25PCI Express Configuration	30
3.6	Boot Settings.....	31
	Figure 3.26Boot Setup Utility	31
3.7	Security Setup.....	32
	Figure 3.27Password Configuration	32
3.8	Save & Exit	33
	Figure 3.28Save & Exit.....	33
3.8.1	Save Changes and Exit.....	33
3.8.2	Discard Changes and Exit.....	33
3.8.3	Save Changes and Reset.....	33
3.8.4	Discard Changes and Reset.....	33
3.8.5	Save Changes	33
3.8.6	Discard Changes	33
3.8.7	Restore Defaults	34
3.8.8	Save User Defaults.....	34
3.8.9	Restore User Defaults	34

Chapter 4 S/W Introduction & Installation..... 35

4.1	S/W Introduction	36
4.2	Driver Installation	36
4.2.1	Windows XP professional.....	36
4.2.2	Other OS.....	36

Appendix A Watchdog Timer..... 37

A.1	Programming the Watchdog Timer	38
-----	--------------------------------------	----

Appendix B Programming GPIO..... 39

B.1	GPIO Register.....	40
-----	--------------------	----

Appendix C System Assignments..... 41

C.1	System I/O Ports.....	42
	Table C.1: System I/O ports.....	42
C.2	DMA Channel Assignments	43
	Table C.2: DMA channel assignments.....	43
C.3	Interrupt Assignments	43

	Table C.3: Interrupt assignments	43
C.4	1st MB Memory Map	44
	Table C.4: 1st MB memory map	44

Chapter 1

General Information

This chapter gives background information on the SOM-5890 CPU System on Module.

Sections include:

- Introduction
- Specification

1.1 Introduction

SOM-5890 is a COM-Express basic module with Type 6 pin-out that fully complies with the PCI Industrial Computer Manufacturers PICMG COM Express standard. The new CPU module integrates Intel 2nd Generation Core i7, i5, i3, and Celeron processors (code name Sandy Bridge) which support Intel 6th generation graphics core with AVC/VC1/MPEG2 HW decode. It also integrates QM67 (codename Cougar Point) chipset which provides state-of-the-art interface such as PCI Express Gen 2 and SATA Gen3. In a basic form factor of 125mm x 95mm, the SOM-5890 provides a scalable high performance and easy to integrate solution for customers' applications by utilizing a plug-in CPU module on an application-specific customer solution board. The SOM-5890 with advanced I/O capacity incorporates serial differential signaling technologies such as PCI Express, Serial ATA, USB 2.0, LVDS and HDMI/DVI/Displayport interfaces. SOM-5890 offers design partners more choices for their own applications needing higher computing speeds while maintaining a basic form factor. SOM-5890 complies with the "Green Function" standard and supports Doze, Standby and Suspend modes. The small size (125 mm x 95 mm) and use of two high capacity connectors based on the proven COM-Basic form factor, allows the COM-basic modules to be easily and securely mounted onto a customized solution board or our standard SOM-DB5700 development board.

The SOM-5890 is a highly integrated multimedia COM module that combines audio, video, and network functions. It provides excellent processing capability via Intel 2nd Gen Core i processor, dual channel LVDS, HDMI, DVI, and Displayport for multi-display, DDR3 non-ECC or ECC memory (A or B version respectively) up to 16 GB, and high definition audio interfaces.

1.2 Specifications

1.2.1 Standard System On Module functions

- **Processor:** Intel® Core™ i7/i5/i3 and Celeron processors
(For detailed CPU support information please contact your sales representative)
- **BIOS:** AMI EFI 8MB Flash
- **Chipset:** Intel® QM67 Chipset
- **Intel Smart Cache:**
 - Intel® Core i7: 6 MB (Quad Core) or 4 MB (Duo Core) Smart Cache
 - Intel® Core i5/i3: 3 MB Smart Cache
 - Intel® Celeron: 2 MB Smart Cache
- **System memory:** 2 204-pin SODIMM support non-ECC (A version) or ECC (B version) DDR3-1066/1333 up to 16GB
- **Power management:** Supports enhanced Intel SpeedStep technology, S0, S3, S4, S5, C0, C1, C1E, C3, C6, C7, and ACPI/APM.
- **SATA interface:** 2 SATAIII channel up to 600MB/s and 2 SATAII channel up to 300MB/s
- **Watchdog timer:** 65536 levels timer interval, from 0 to 65535 sec multi-level and multi-option WatchDog Timer
- **USB interface:** Supports 8 USB 2.0 ports
- **Expansion Interface:** Supports PEG x16, 7 PCIe x1 (PCIe x4 option), LPC, SMBus, I²C

1.2.2 Display Interface

- **Chipset:** Intel Core i processor integrated 6th generation graphics core with 12 execution units. Support DX10.1, Open GL 3.0, full AVC/VC1/MPEG2 HW Decode
- **Display type:** VGA, LVDS, HDMI, DVI, Displayport
- **Display mode:**
 - VGA port: 2048x1536
 - LVDS: Dual Channel 18/24-bit
 - HDMI/DVI: 1920x1200
 - Displayport: 2560x1600
 - GMA driver supports up to 2 independent displays
 - Four independent display supported with hybrid multi-monitor capability (integrated and discrete graphics working simultaneously).

1.2.3 Audio function

- **Audio interface:** Intel high definition audio interface

1.2.4 Ethernet

- **Chipset:** Intel 82579LM Gigabit Ethernet. Base on IEEE 10BASE-T, 100BASE-TX and 1000BASE-T standard.

1.2.5 iManager

- Board information
- Multi-level stage WDT (IRQ, SCI, HW restart, and power off)
- Hardware monitor for +12 V, +5 VSB, CMOS Battery, CPU temperature
- Smart fan (full speed, manual speed, auto speed)
- SMBus/I²C Bus
- Deep Sleep Mode in S4/S5

1.2.6 Mechanical and environmental

- **Dimensions:** COM-Basic form-factor, 125 mm x 95 mm (4.92" x 3.74")
- **Power supply voltage:** +12 V power only (+5 VSB is need for ACPI and ATX power)
- **Power requirement:** SOM-5890FG-U1B1E w/ DDR3-1333 2GB ECC Memory 3.57A @ +12V
- **Operating temperature:** 0 ~ 60° C (32 ~ 140° F)
- **Operating humidity:** 0% ~ 90% relative humidity, non-condensing
- **Weight:** 0.103 Kg (weight of total package)

Chapter 2

Mechanical Information

This chapter gives mechanical and connector information on the SOM-5890 CPU System on Module.

Sections include:

- Connector Information
- Mechanical Drawing

2.1 Connectors

2.1.1 Board Connector

There are two connectors at the rear side of SOM-5890 for connecting to carrier boards.

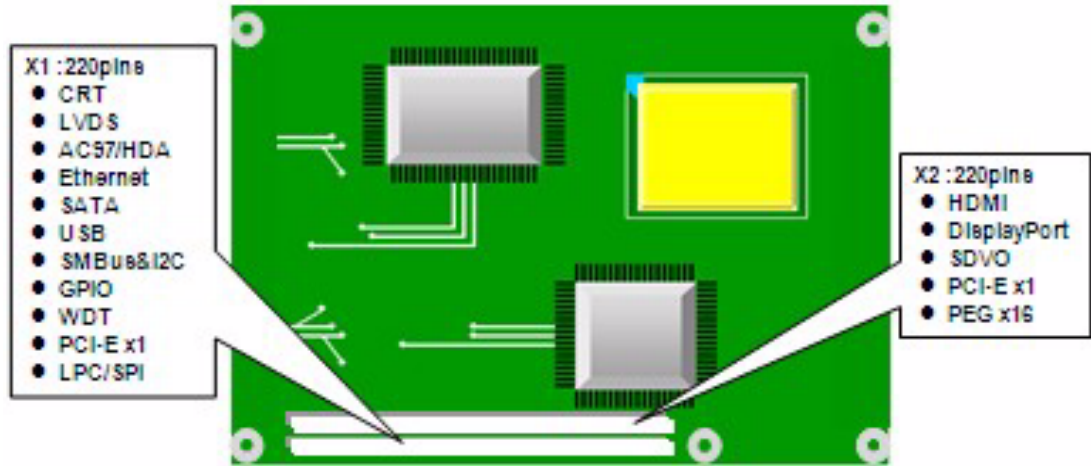

Pin Assignments for X1/X2 connector

Please refer to Advantech_COM_Express_Design Guide, Chapter 2.

You can download Advantech_COM_Express_Design Guide from <http://com.advantech.com/>

2.1.2 Connector List

FAN1	Fan
Description	Wafer 2.0 mm 3P 90D (M) DIP 2001-WR-03-LF W/Lock
Pin	Pin Name
1	Fan Tacho-Input
2	Fan Out
3	GND

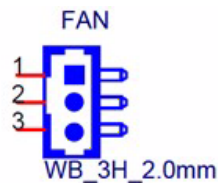

2.2 Mechanical

2.2.1 Jumper and Connector Location

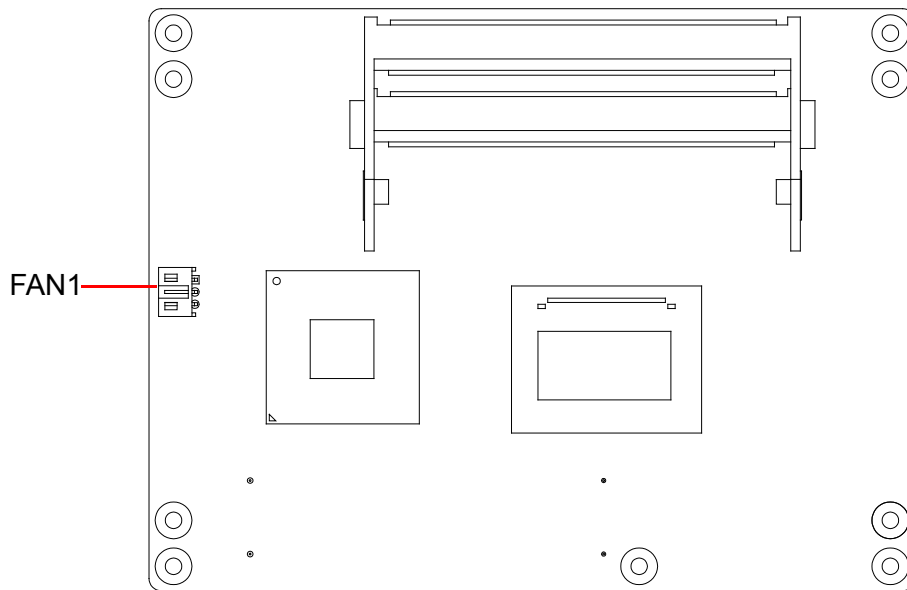

Figure 2.1 Board Layout (component side)

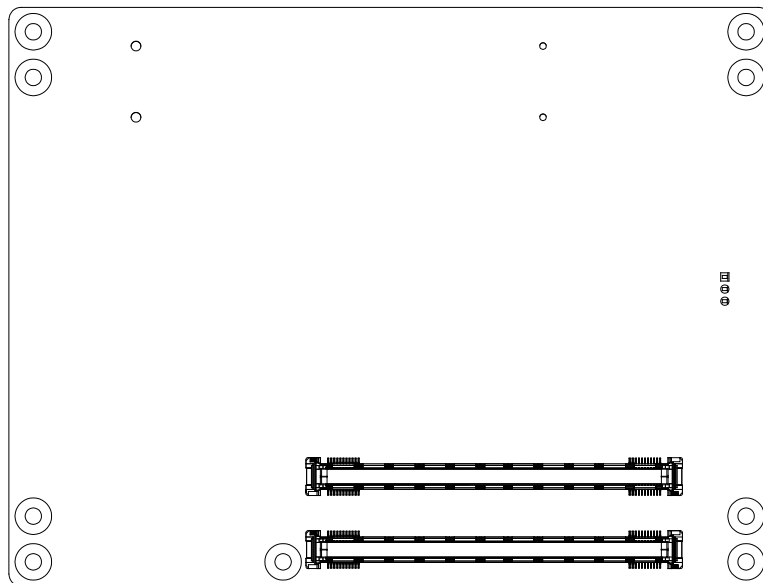

Figure 2.2 Board Layout (Solder side)

2.2.2 Board Dimension

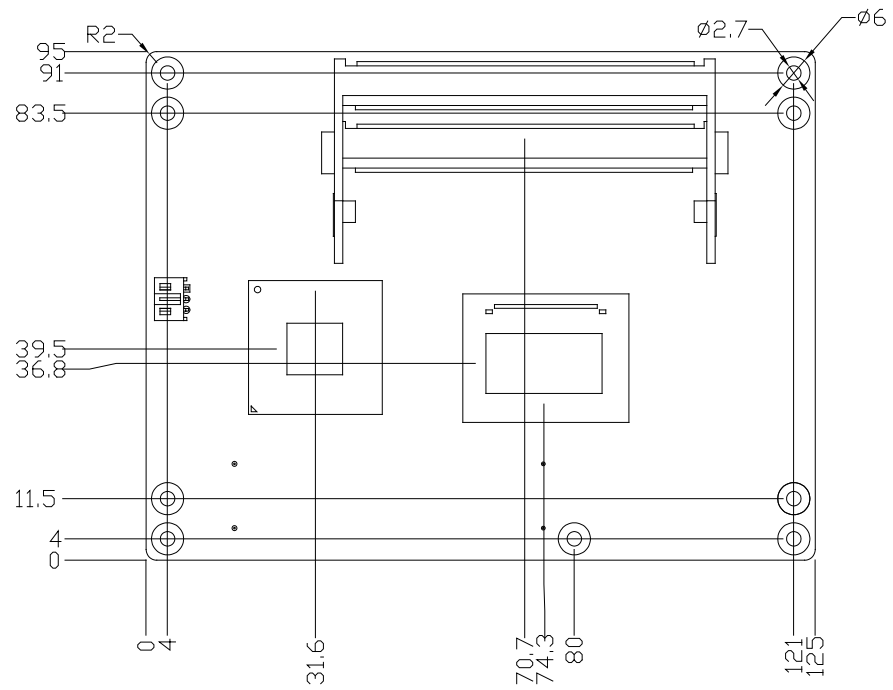

Figure 2.3 Board Dimension (Component side)

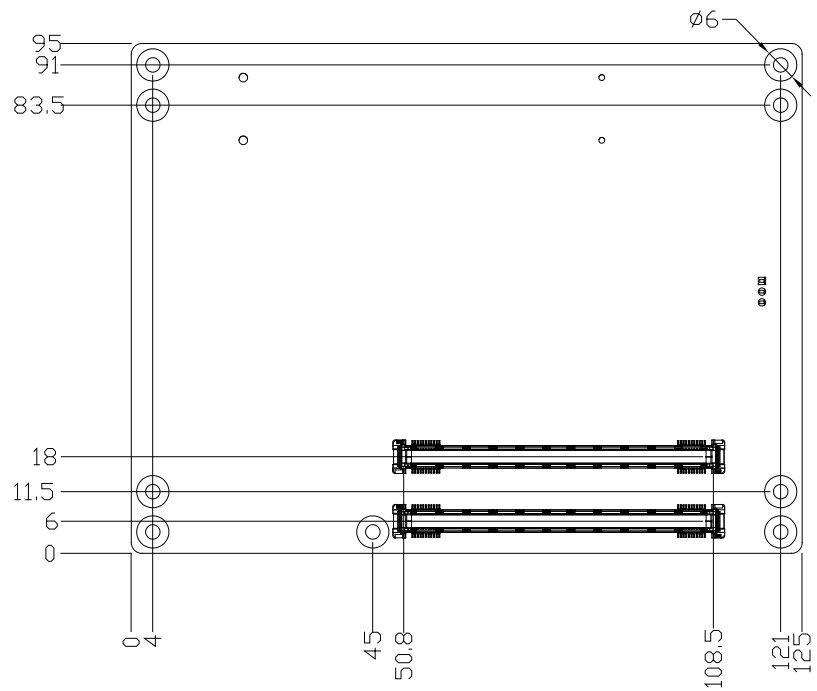

Figure 2.4 Board Dimension (Solder side)

Chapter 3

BIOS Setup

3.1 BIOS Setup

AMIBIOS has been integrated into many motherboards for over a decade. With the AMIBIOS Setup program, users can modify BIOS settings and control various system features. This chapter describes the basic navigation of the SOM-5890 BIOS setup screens.



Figure 3.1 Setup program initial screen

AMI's BIOS ROM has a built-in Setup program that allows users to modify the basic system configuration. This information is stored in flash ROM so it retains the Setup information when the power is turned off.

3.2 Entering Setup

Turn on the computer and then press <F2> or to enter Setup menu.

3.3 Main Setup

When users first enter the BIOS Setup Utility, users will enter the Main setup screen. Users can always return to the Main setup screen by selecting the Main tab. There are two Main Setup options. They are described in this section. The Main BIOS Setup screen is shown below.



Figure 3.2 Main setup screen

The Main BIOS setup screen has two main frames. The left frame displays all the options that can be configured. Grayed-out options cannot be configured; options in blue can. The right frame displays the key legend.

Above the key legend is an area reserved for a text message. When an option is selected in the left frame, it is highlighted in white. Often a text message will accompany it.

3.3.1 System time / System date

Use this option to change the system time and date. Highlight System Time or System Date using the <Arrow> keys. Enter new values through the keyboard. Press the <Tab> key or the <Arrow> keys to move between fields. The date must be entered in MM/DD/YY format. The time must be entered in HH:MM:SS format.

3.4 Advanced BIOS Features Setup

Select the Advanced tab from the SOM-5890 setup screen to enter the Advanced BIOS Setup screen. Users can select any item in the left frame of the screen, such as CPU Configuration, to go to the sub menu for that item. Users can display an Advanced BIOS Setup option by highlighting it using the <Arrow> keys. All Advanced BIOS Setup options are described in this section. The Advanced BIOS Setup screens are shown below. The sub menus are described on the following pages.

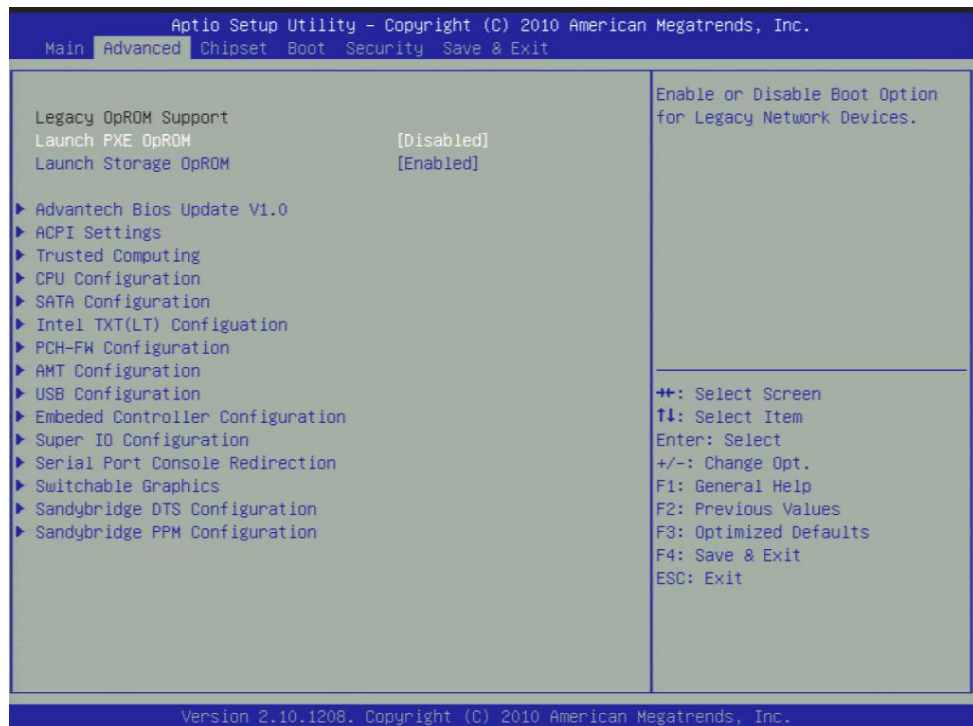

Figure 3.3 Advanced BIOS features setup screen

- **Launch PXE OpROM**
This item allows users to enable or disable launch PXE OpROM if available.
- **Launch Storage OpROM**
This item allows users to enable or disable launch storage OpROM if available.

3.4.1 ACPI Settings

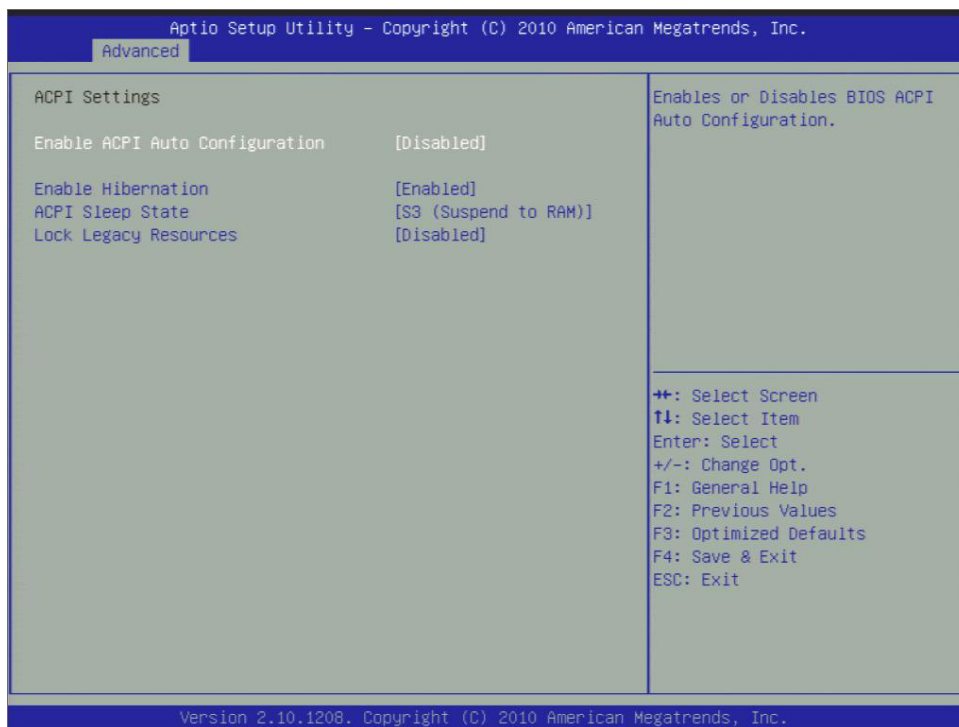

Figure 3.4 ACPI Setting

- **Enable ACPI Auto Configuration**
This item allows users to enable or disable BIOS ACPI auto configuration.
- **Enable Hibernation**
This item allows users to enable or disable hibernation.
- **ACPI Sleep State**
This item allows users to set the ACPI sleep state.
- **Lock Legacy Resources**
This item allows users to lock legacy devices' resources.

3.4.2 TPM Configuration

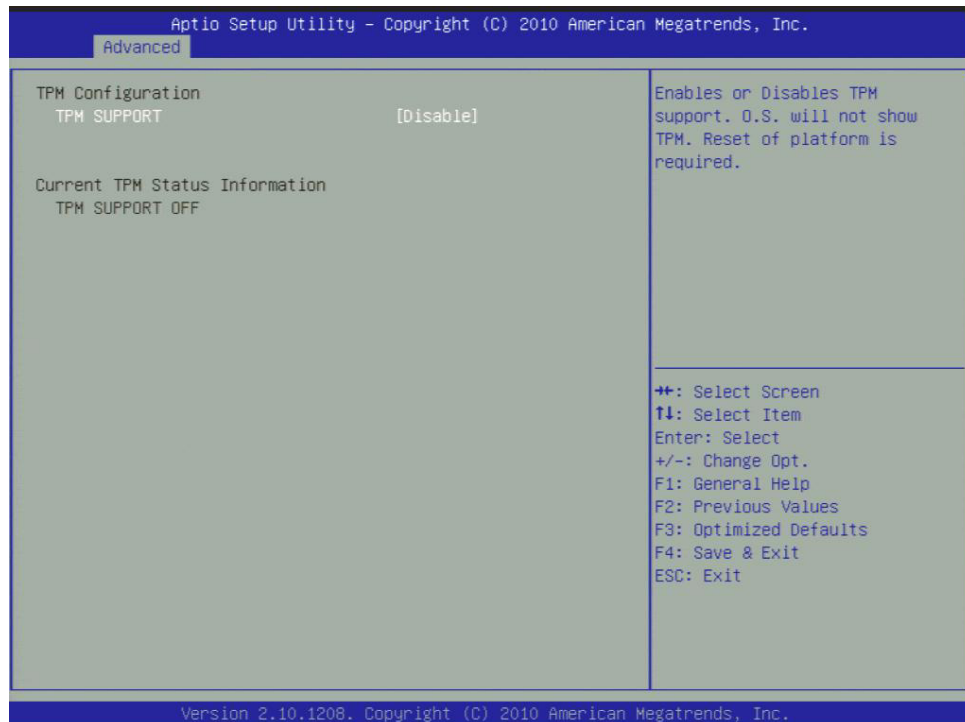

Figure 3.5 TPM Configuration

- **TPM Support**
Disable/Enable TPM if available.

3.4.3 CPU Configuration

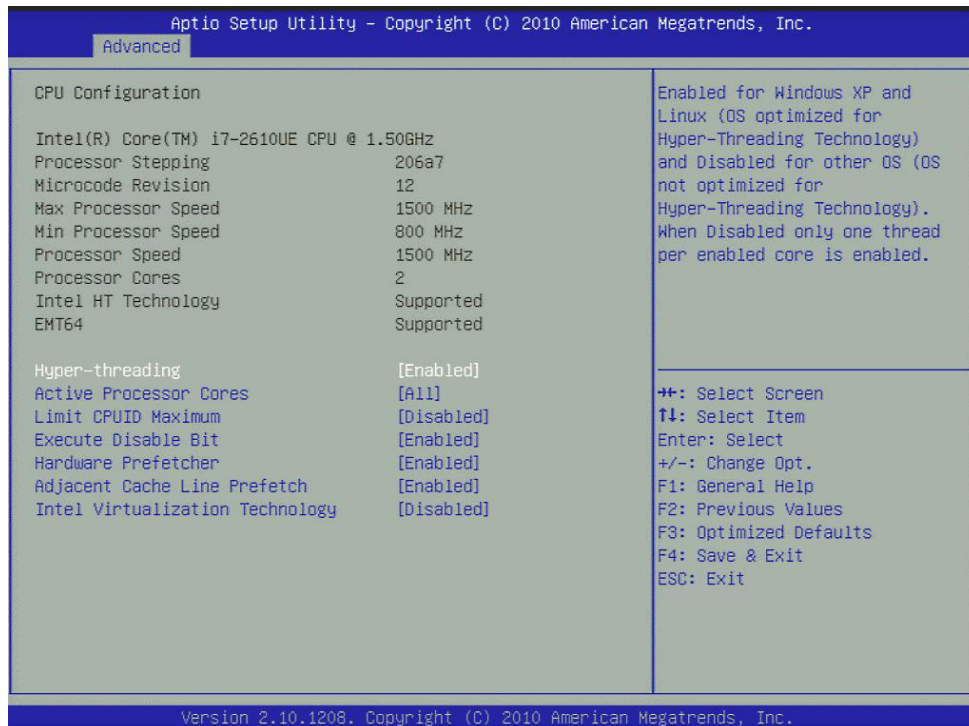

Figure 3.6 CPU Configuration

- **Hyper Threading Technology**
This item allows users to enable or disable Intel® Hyper Threading technology.
- **Active Processor Cores**
This item allows users to set how many processor cores should be active.
- **Limit CPUID Maximum**
This item allows users to limit the maximum value of CPUID.
- **Execute Disable Bit**
This item allows users to enable or disable the No-Execution page protection technology.
- **Hardware Prefetcher**
This item allows users to enable or disable the hardware prefetcher feature.
- **Adjacent Cache Line Prefetch**
This item allows users to enable or disable the adjacent cache line prefetch feature.
- **Intel Virtualization Technology**
This item allows users to enable or disable the intel virtualization technology.

3.4.4 SATA Configuration

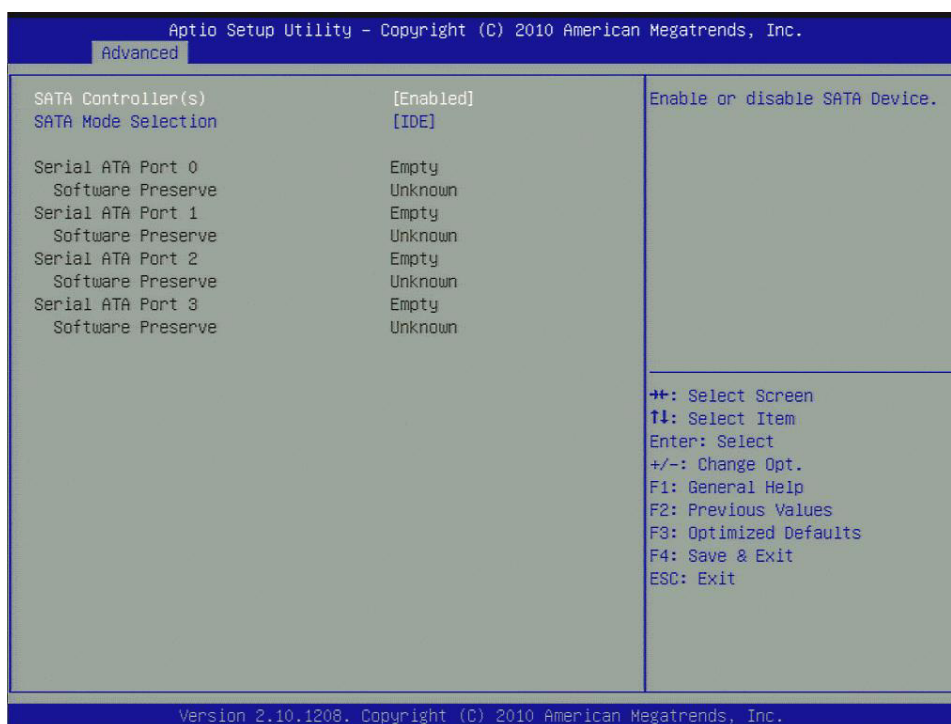

Figure 3.7 SATA Configuration

- **SATA Controller(s)**
This item allows users to enable or disable the SATA controller(s).
- **SATA Mode Selection**
This item allows users to select mode of SATA controller(s).

3.4.5 Intel TXT(LT) Configuration

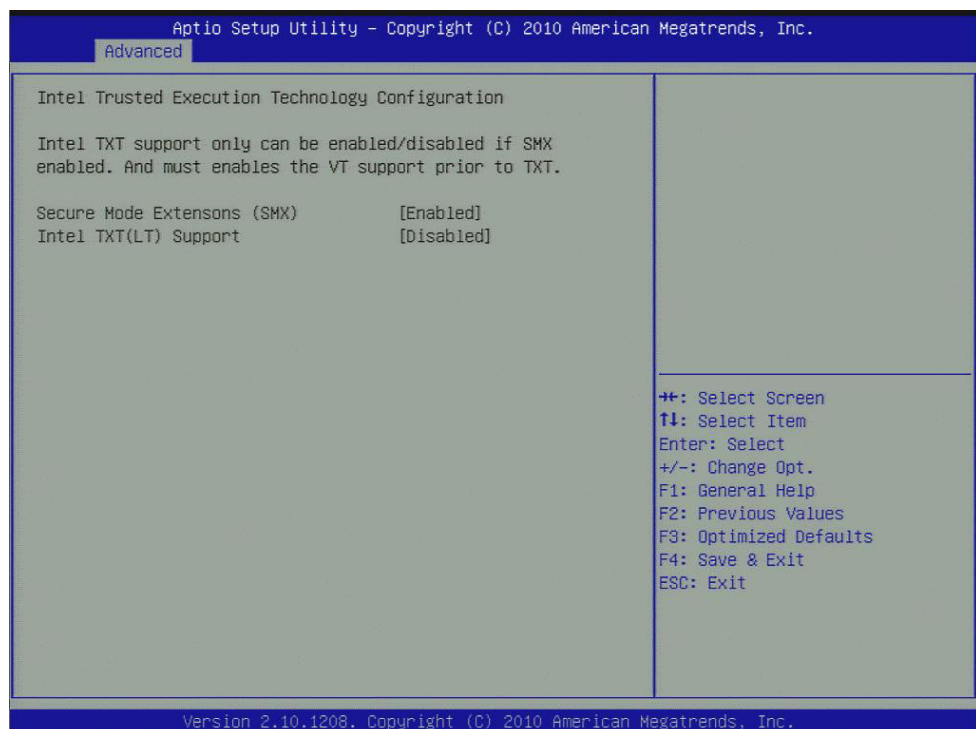

Figure 3.8 Intel TXT(LT) Configuration

- **Secure Mode Extensions (SMX)**
This item allows users to enable or disable SMX.
- **Intel TXT(LT) Support**
This item allows users to enable or disable Intel TXT.

3.4.6 PCH-FW Configuration



Figure 3.9 PCH-FW Configuration

- **Me FW Image Re-Flash**

This item allows users to enable or disable Me FW image re-flash function.

3.4.7 AMT Configuration

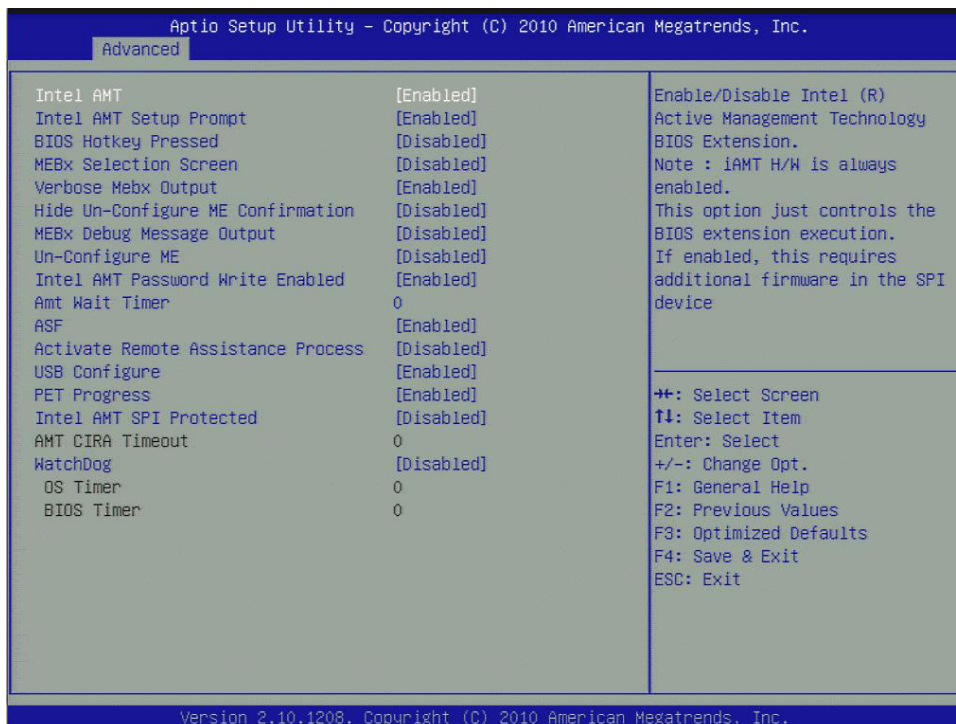

Figure 3.10 AMT Configuration

-
- **Intel AMT**
This item allows users to enable or disable Intel AMT BIOS extension.
 - **Intel AMT Setup Prompt**
This item allows users to enable or disable Intel AMT setup prompt.
 - **BIOS Hotkey Pressed**
This item allows users to enable or disable BIOS hotkey press.
 - **MEBx Selection Screen**
This item allows users to enable or disable MEBx selection screen.
 - **Verbose MEBx Output**
This item allows users to enable or disable MEBx verbose output.
 - **Hide Un-Configuration ME Confirmation**
This item allows users to hide un-configure ME without password confirmation prompt.
 - **MEBx Debug Message Output**
This item allows users to enable or disable MEBx debug message.
 - **Un-Configure ME**
This item allows users to un-configure ME without password.
 - **Intel AMT Password Write Enable**
This item allows users to enable or disable Intel AMT password write.
 - **Amt Wait Timer**
Set timer to wait before sending ASF_GET_BOOT_OPTIONS.
 - **ASF**
This item allows users to enable or disable Alert Specification Format.
 - **Activate Remote Assistance Process**
This item allows users to enable or disable trigger CIRA boot.
 - **USB Configure**
This item allows users to enable or disable USB configure function.
 - **PET Progress**
This item allows users to enable or disable PET events progress to receive PET events or not.
 - **Intel AMT SPI Protected**
This item allows users to enable or disable Intel AMT SPI write protect.
 - **AMT CIRA Timeout**
OEM defined timeout for MPS connection to be established.
 - **WatchDog**
This item allows users to enable or disable WatchDog Timer.
 - **OS Timer**
Sets OS watchdog timer.
 - **BIOS Timer**
Sets BIOS watchdog timer.

3.4.8 USB Configuration



Figure 3.11 USB Configuration

- **Legacy USB Support**
Enable the support for legacy USB. Auto option disables legacy support if no USB devices are connected.
- **EHCI Hand-Off**
This is a workaround for the OS without EHCI hand-off support. The EHCI ownership change should claim by EHCI driver.
- **USB transfer time-out**
Set the time-out value for Control, Bulk, and Interrupt transfers.
- **Device reset time-out**
Set USB mass storage device Start Unit command time-out value.
- **Device power-up delay**
Sets the maximum time the device will take before it properly reports itself to the Host Controller. 'Auto' uses a default value: for a Root port it is 100 ms, for a Hub port the delay is taken from the Hub descriptor.

3.4.9 Embedded Controller Configuration



Figure 3.12 Embedded Controller Configuration

- **EC iManager WatchDog IRQ**
This item allows users to set the irq number of EC watchdog.
- **EC Power Saving Mode**
This item allows users to set board's power saving mode when off.
- **CPU Shutdown Temperature**
This item allows users to set the value of CPU shutdown temperature.
- **EC iManager Smart FAN**
This item allows users to enable or disable smart FAN feature.
- **EC Serial Port A**
This item allows users to enable or disable EC serial port A.
- **EC Serial Port B**
This item allows users to enable or disable EC serial port B.
- **Backlight Enable Polarity**
This item allows users to set backlight enable polarity.

3.4.10 Super IO Configuration

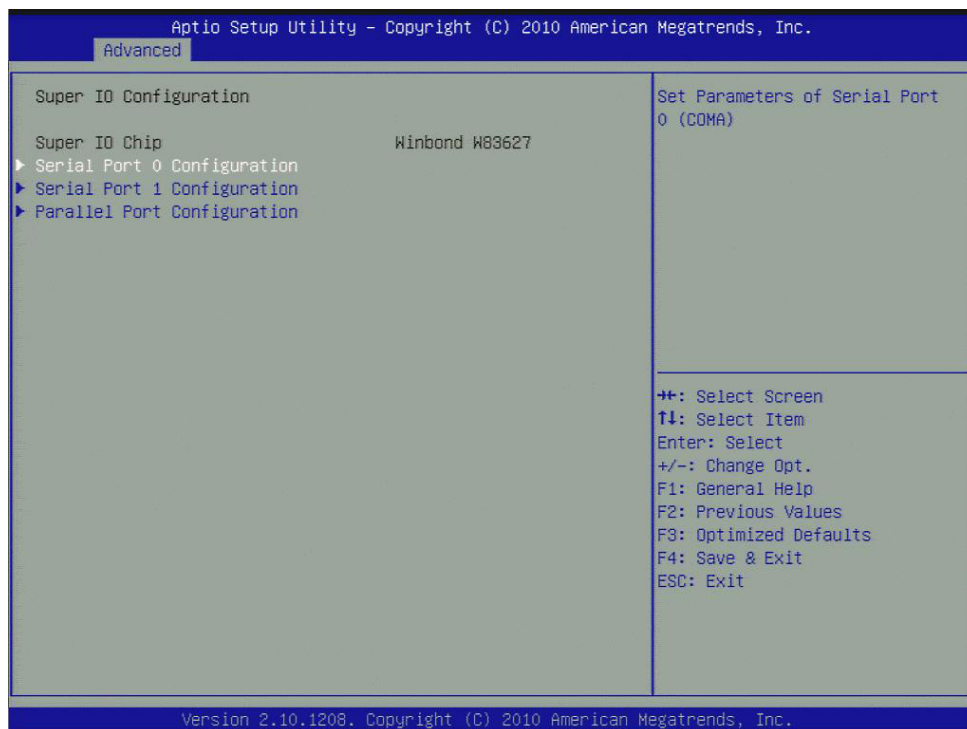

Figure 3.13 Super IO Configuration

- **Serial Port 0 Configuration**
This item allows users to configure serial port 0.
- **Serial Port 1 Configuration**
This item allows users to configure serial port 1.
- **Parallel Port Configuration**
This item allows users to configure parallel port.

3.4.11 Serial Port Console Redirection



Figure 3.14 Serial Port Console Redirection

- **Console Redirection**
This item allows users to enable or disable console redirection for Microsoft Windows Emergency Management Services (EMS).
- **Out-of-Band Mgmt Port**
Select the port for Microsoft Windows Emergency Management Services (EMS) to allow for remote management of a Windows Server OS.
- **Terminal Type**
VT-UTF8 is the preferred terminal type for out-of-band management. The next best choice is VT100+ and then VT100. See above, in Console Redirection Settings page, for more Help with Terminal Type/Emulation.

3.4.12 Switchable Graphics



Figure 3.15 Switchable Graphics

- **SG Mode Select**

This item allows users to select switchable graphics mode.

3.4.13 Sandybridge DTS Configuration

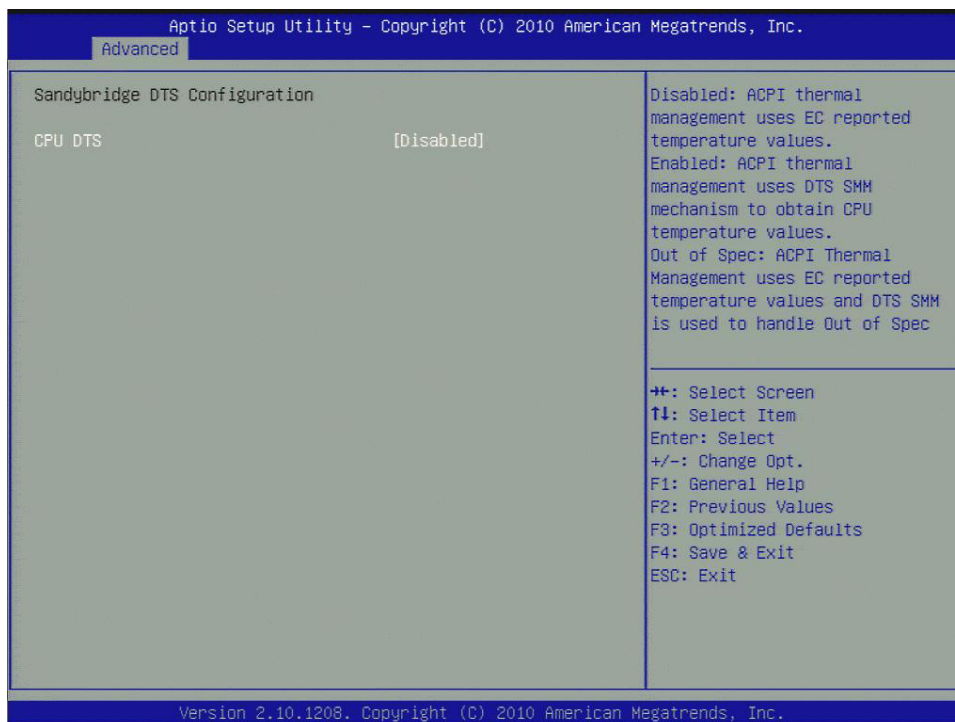

Figure 3.16 Sandybridge DTS Configuration

- **CPU DTS**
This item allows users to enable or disable CPU DTS.

3.4.14 Sandybridge PPM Configuration



Figure 3.17 Sandybridge PPM Configuration

- **EIST**
CPU runs at its default speed if disabled; CPU speed is controlled by the operating system if enabled.
- **Turbo Mode**
This item allows users to enable or disable turbo mode.
- **CPU C3/C6/C7 Report**
This item allows users to enable or disable CPU C-state support.

3.5 Chipset

Select the Chipset tab from the SOM-5890 setup screen to enter the Chipset BIOS Setup screen. You can display a Chipset BIOS Setup option by highlighting it using the <Arrow> keys. All Plug and Play BIOS Setup options are described in this section. The Plug and Play BIOS Setup screen is shown below.

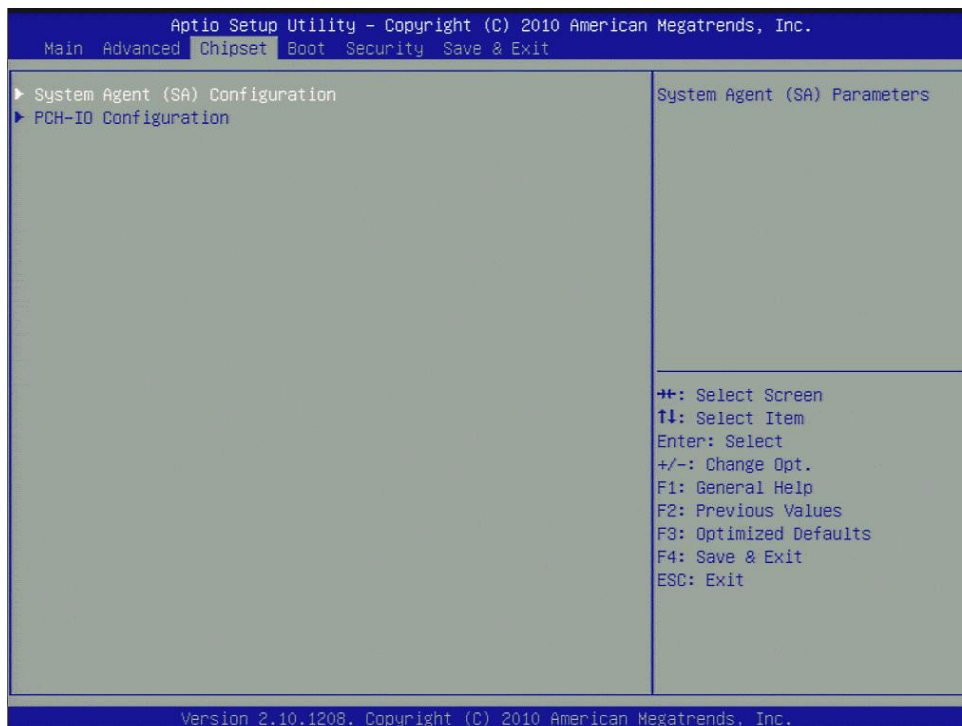

Figure 3.18 Chipset Setup

3.5.1 System Agent (SA) Configuration



Figure 3.19 System Agent (SA) Configuration

- **VT-d**
This item allows users to enable or disable VT-d.
- **Primary Display**
This item allows users to select which graphics controller to use as the primary boot device.

3.5.1.1 Intel IGFX Configuration



Figure 3.20 Intel IGFX Configuration

- **Internal Graphics**
This item allows users to enable or disable IGD.
- **GTT Size**
This item allows users to select GTT size.
- **Aperture Size**
This item allows users to select aperture size.
- **DVMT Pre-Allocated**
This item allows users to select DVMT pre-allocated memory size.
- **DVMT Total Gfx Mem**
This item allows users to select DVMT total memory size.
- **Gfx Low Power Mode**
This item allows users to enable or disable IGD low power mode.

LCD Control



Figure 3.21 LCD Control

- **Primary IGFX Boot Display**
Select boot display device at post stage.
- **LCD Panel Type**
This item allows users to select panel resolution.
- **Panel Scaling**
This item allows users to enable or disable panel scaling.
- **Active LFP**
This item allows users to select LFP configuration.

3.5.1.2 NB PCIe Configuration



Figure 3.22 NB PCIe Configuration

- **PEG0 - Gen x**
Select PEG0 speed.
- **Always Enable PEG**
This item allows users to enable or disable PEG always.
- **PEG ASPM**
This item allows users to enable or disable PEG ASPM.

3.5.2 PCH-IO Configuration

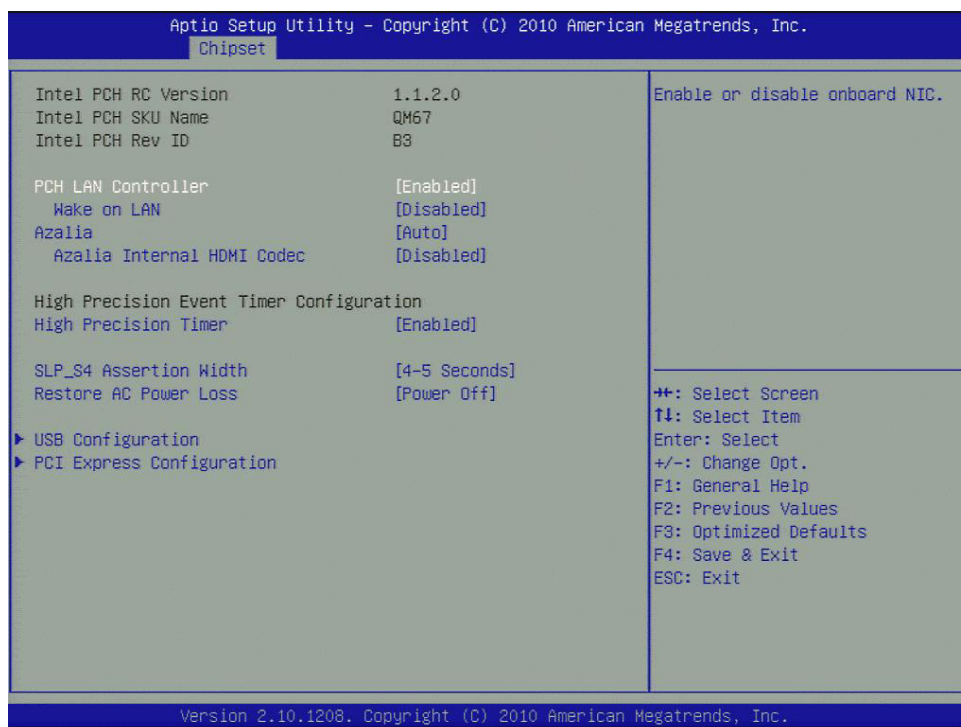

Figure 3.23 PCH-IO Configuration

- **PCH LAN controller**
Enables or disables the PCH LAN controller.
- **Wake on LAN**
Enables or disables PCH LAN wake up from sleep state.
- **Azalia Controller**
Enables or disables the azalia controller.
- **Azalia Internal HDMI codec**
Enables or disables the azalia internal HDMI codec.
- **High Precision Timer**
Enables or disables the high precision timer.
- **SLP_S4 Assertion Width**
This item allows users to set a delay of sorts.
- **Restore AC Power Loss**
This item allows users to select off, on and last state.

3.5.2.1 USB Configuration

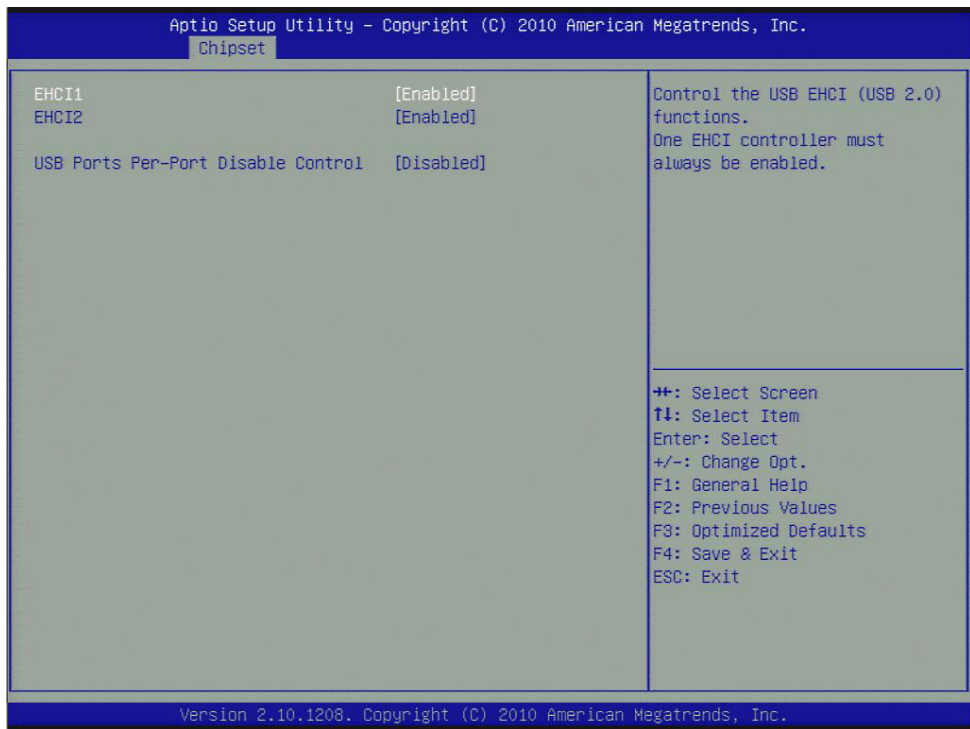

Figure 3.24 USB Configuration

- **EHCI1/EHCI2**
Enables or disables the EHCI controller.
- **USB Ports Per-Port Disable Control**
This item allows users to enable or disable each USB port individually.

3.5.2.2 PCI Express Configuration

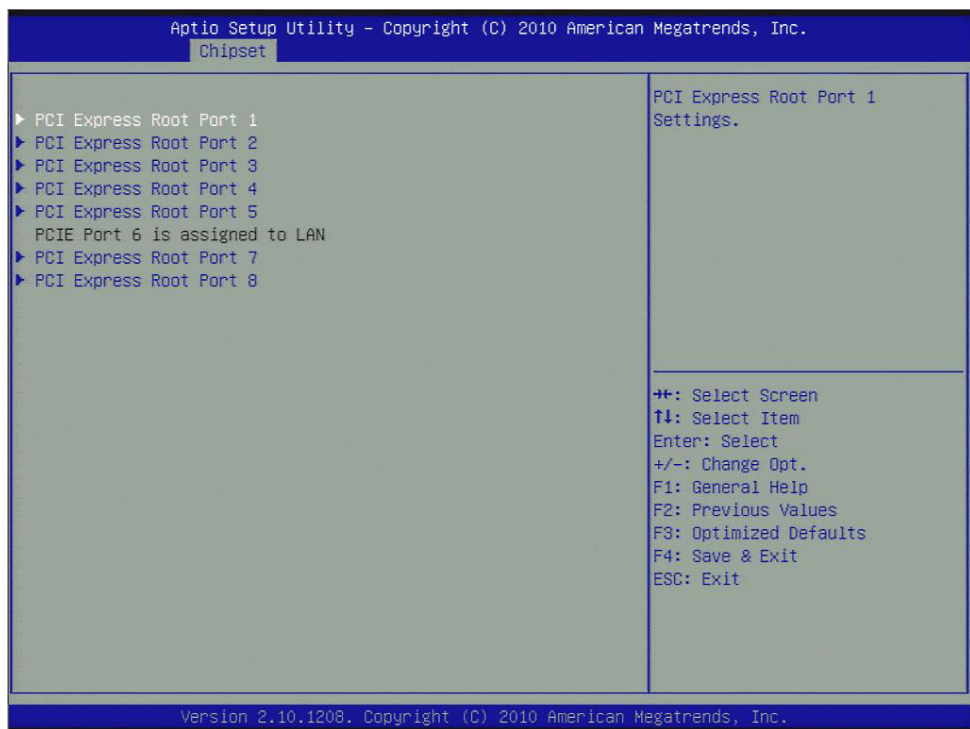

Figure 3.25 PCI Express Configuration

- **PCI Express Root Port x**
This item allows users to configure PCI express ports.

3.6 Boot Settings



Figure 3.26 Boot Setup Utility

- **Setup Prompt Timeout**
This item allows users to select the number of seconds to wait for setup activation key.
- **Bootup NumLock State**
Select the Power-on state for Numlock.
- **Quiet Boot**
If this option is set to Disabled, the BIOS displays normal POST messages. If Enabled, an OEM Logo is shown instead of POST messages.
- **Option ROM Message**
Set display mode for option ROM.
- **Interrupt 19 Capture**
This item allows option ROMs to trap interrupt 19.
- **1st/2nd/3rd/4th/5th/6th/7th Boot**
This item allows users to set boot device priority.

3.7 Security Setup

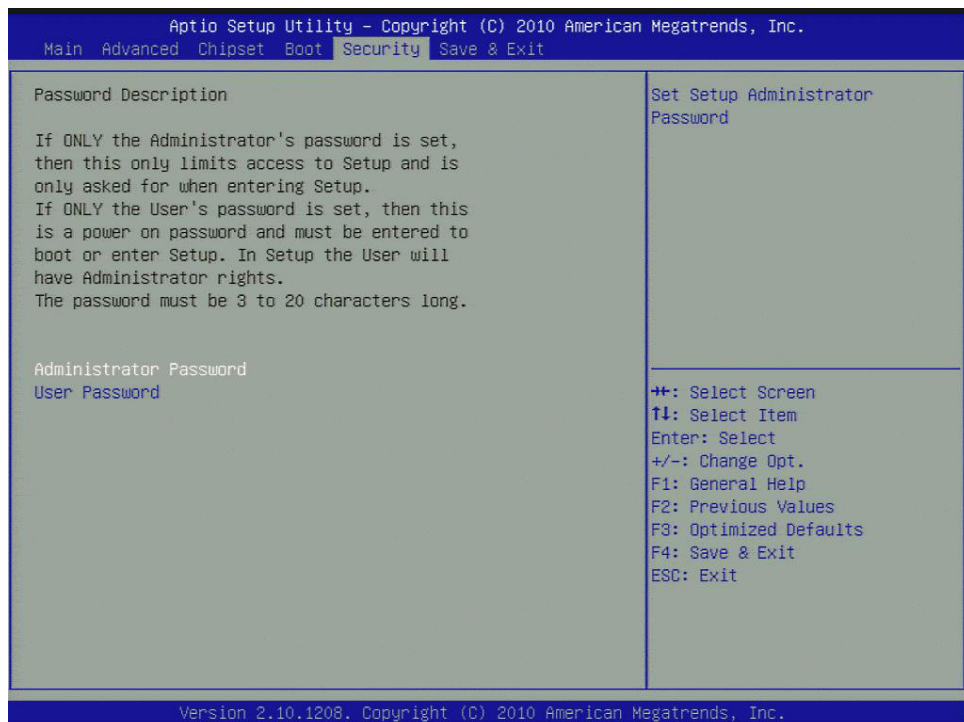

Figure 3.27 Password Configuration

Select Security Setup from the SOM-5890 Setup main BIOS setup menu. All Security Setup options, such as password protection is described in this section. To access the sub menu for the following items, select the item and press <Enter>:

- **Change Administrator / User Password**

Select this option and press <ENTER> to access the sub menu, and then type in the password.

3.8 Save & Exit

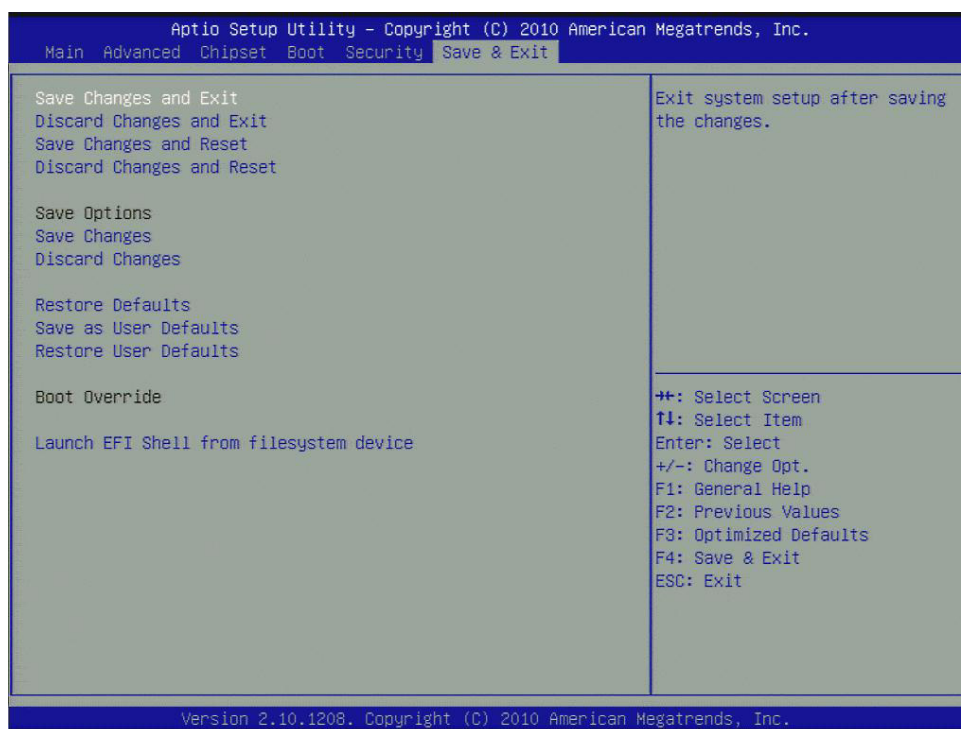

Figure 3.28 Save & Exit

3.8.1 Save Changes and Exit

When users have completed system configuration, select this option to save changes, exit BIOS setup menu and reboot the computer if necessary to take effect of all system configuration parameters.

3.8.2 Discard Changes and Exit

Select this option to quit Setup without making any permanent changes to the system configuration.

3.8.3 Save Changes and Reset

When users have completed system configuration, select this option to save changes, exit the BIOS setup menu and reboot the computer to take effect of all system configuration parameters.

3.8.4 Discard Changes and Reset

Select this option to quit Setup without making any permanent changes to the system configuration and reboot the computer.

3.8.5 Save Changes

When users have completed system configuration, select this option to save changes without exiting the BIOS setup menu.

3.8.6 Discard Changes

Select this option to discard any current changes and load previous system configuration.

3.8.7 Restore Defaults

The SOM-5890 automatically configures all setup items to optimal settings when users select this option. Optimal Defaults are designed for maximum system performance, but may not work best for all computer applications. In particular, do not use the Optimal Defaults if the user's computer is experiencing system configuration problems.

3.8.8 Save User Defaults

When users have completed system configuration, select this option to save changes as user defaults without exit BIOS setup menu.

3.8.9 Restore User Defaults

The users can select this option to restore user defaults.

Chapter 4

S/W Introduction &
Installation

4.1 S/W Introduction

The mission of Advantech Embedded Software Services is to "Enhance quality of life with Advantech platforms and Microsoft Windows embedded technology." We enable Windows Embedded software products on Advantech platforms to more effectively support the embedded computing community. Customers are freed from the hassle of dealing with multiple vendors (Hardware suppliers, System integrators, Embedded OS distributor) for projects. Our goal is to make Windows Embedded Software solutions easily and widely available to the embedded computing community.

4.2 Driver Installation

The Intel Chipset Software Installation (CSI) utility installs the Windows INF files that outline to the operating system how the chipset components will be configured.

4.2.1 Windows XP professional

To install the drivers please connect to internet and browse the website <http://support.advantech.com.tw>, download the drivers that you want to install and follow Driver Setup instructions to complete the installation.

4.2.2 Other OS

To install the drivers for Other Windows OS or Linux, please connect to internet and browse the website <http://support.advantech.com.tw> to download the setup file.

Appendix **A**

Watchdog Timer

This appendix gives you the information about the watchdog timer programming on the SOM-5890 CPU System on Module.

Sections include:

- Watchdog Timer Programming

A.1 Programming the Watchdog Timer

Trigger Event	Note
IRQ	IRQ7, 9, 11 (default disable) IRQ can be set in BIOS
NMI	N/A
SCI	Power button event
Power Off	Support
H/W Restart	Support
External WDT	N/A

For details, please refer to *iManager & Software API User Manual* Chapter 6. Programming Overview 6.2 Watchdog (WDog) Functions Class.

Appendix **B**

Programming GPIO

This Appendix gives the illustration of the General Purpose Input and Output pin setting.

Sections include:

- System I/O ports

B.1 GPIO Register

GPIO Byte Mapping	H/W Pin Name
BIT0	GPO0
BIT1	GPO1
BIT2	GPO2
BIT3	GPO3
BIT4	GPI0
BIT5	GPI1
BIT6	GPI2
BIT7	GPI3

For details, please refer to *iManager & Software API User Manual* Chapter 6. Programming Overview 6.3 GPIO (I/O) Functions

Appendix **C**

System Assignments

This appendix gives you the information about the system resource allocation on the SOM-5890 CPU System on Module.

Sections include:

- System I/O ports
- DMA Channel Assignments
- Interrupt Assignments
- 1st MB Memory Map

C.1 System I/O Ports

Table C.1: System I/O ports

Addr.range(Hex)	Device
0000 - 000F	Direct memory access controller
0000 - 0CF7	PCI bus
0010 - 001F	Motherboard resources
0020 - 0021	Programmable interrupt controller
0022 - 003F	Motherboard resources
0040 - 0043	System timer
0044 - 005F	Motherboard resources
0060 - 0060	Standard 101/102-Key or Microsoft Natural PS/2 Keyboard
0061 - 0061	System speaker
0062 - 0062	Microsoft ACPI-Compliant Embedded Controller
0063 - 0063	Motherboard resources
0064 - 0064	Standard 101/102-Key or Microsoft Natural PS/2 Keyboard
0065 - 0065	Motherboard resources
0066 - 0066	Microsoft ACPI-Compliant Embedded Controller
0067 - 006F	Motherboard resources
0070 - 0071	System CMOS/real time clock
0072 - 007F	Motherboard resources
0080 - 0080	Motherboard resources
0081 - 0083	Direct memory access controller
0084 - 0086	Motherboard resources
0087 - 0087	Direct memory access controller
0088 - 0088	Motherboard resources
0089 - 008B	Direct memory access controller
008C - 008E	Motherboard resources
008F - 008F	Direct memory access controller
0090 - 009F	Motherboard resources
00A0 - 00A1	Programmable interrupt controller
00A2 - 00BF	Motherboard resources
00C0 - 00DF	Direct memory access controller
00E0 - 00EF	Motherboard resources
00F0 - 00FF	Numeric data processor
01F0 - 01F7	Primary IDE Channel
0274 - 0277	ISAPNP Read Data Port
0279 - 0279	ISAPNP Read Data Port
02F8 - 02FF	Communications Port (COM2)
0378 - 037F	Printer Port (LPT1)
03B0 - 03BB	Intel(R) HD Graphic
03C0 - 03DF	Intel(R) HD Graphic
03F6 - 03F6	Primary IDE Channel
03F8 - 03FF	Communications Port (COM1)
0400 - 041F	Motherboard resources
04D0 - 04D1	Motherboard resources
0500 - 053F	Motherboard resources

Table C.1: System I/O ports

0800 - 087F	Motherboard resources
0A00 - 0A0F	Motherboard resources
0A79 - 0A79	ISAPNP Read Data Port
0D00 - FFFF	PCI bus

C.2 DMA Channel Assignments

Table C.2: DMA channel assignments

Channel	Function
0	Available
1	Available
2	Available
3	Available
4	Direct memory access controller
5	Available
6	Available
7	Available

C.3 Interrupt Assignments

Table C.3: Interrupt assignments

Interrupt#	Interrupt source
NMI	Parity error detected
IRQ 0	System timer
IRQ 1	Standard 101/102-Key or Microsoft Natural PS/2 Keyboard
IRQ 2	Available
IRQ 3	Communications Port (COM2)
IRQ 4	Communications Port (COM1)
IRQ 5	Available
IRQ 6	Available
IRQ 7	Available
IRQ 8	System CMOS/real time clock
IRQ 9	Microsoft ACPI-Compliant System
IRQ 10	Available
IRQ 11	Available
IRQ 12	PS/2 Compatible Mouse
IRQ 13	Numeric data processor
IRQ 14	Primary IDE Channel
IRQ 15	Available

C.4 1st MB Memory Map

Table C.4: 1st MB memory map

Addr. range (Hex)	Device
00000000 - 0009FFFF	System board
000A0000 - 000BFFFF	Intel(R) HD Graphic
000A0000 - 000BFFFF	PCI Bus
000C0000 - 000CFFFF	System board
000D0000 - 000DFFFF	PCI bus
000E0000 - 000FFFFFF	System board

ADVANTECH

Enabling an Intelligent Planet

www.advantech.com

Please verify specifications before quoting. This guide is intended for reference purposes only.

All product specifications are subject to change without notice.

No part of this publication may be reproduced in any form or by any means, electronic, photocopying, recording or otherwise, without prior written permission of the publisher.

All brand and product names are trademarks or registered trademarks of their respective companies.

© Advantech Co., Ltd. 2011