

# Reference Only

**Wire Wound Chip Common Mode Choke Coil**  
**DLW5ATH□□□TQ2□ Murata Standard Reference Specification [AEC-Q200]**

**1. Scope**

This reference specification applies to Wire Wound Chip Common Mode Choke Coil DLW5ATH\_TQ Series for Automotive Electronics based on AEC-Q200.

**2. Part Numbering**

(ex.)  $\frac{DL}{(1)} \frac{W}{(2)} \frac{5A}{(3)} \frac{T}{(4)} \frac{H}{(5)} \frac{111}{(6)} \frac{T}{(7)} \frac{Q}{(8)} \frac{2}{(9)} \frac{L}{(10)}$

- |                                  |  |
|----------------------------------|--|
| (1) Chip Common Mode Choke Coil  | (6) Impedance (Typ. at 100MHz)   |
| (2) Structure (W : Winding Type) | (7) Circuit  |
| (3) Dimension (L × W)            | (8) Features   |
| (4) Type                         | (9) Number of Line   |
| (5) Category                     | (10) Packaging Code L : Taping (φ 180mm/reel)<br>K : Taping (φ 330mm/reel)<br>B : Bulk |

**3. Rating**

Customer Part Number	MURATA Part Number	Impedance at 10MHz, Under Standard Testing Conditions (Ω +/-25%)	Impedance at 100MHz, Under Standard Testing Conditions (Ω Typ.)	Rated Voltage V(DC)	Withstanding Voltage V(DC)	Rated Current(*) (A)		DC Resistance (Rdc) (Ω max.)	Insulation Resistance (MΩ min.)	ESD Rank 2.2kV
						at 105°C	at 125°C			
	DLW5ATH450TQ2L	4.7	45	50	125	4.0	2.5	0.013	10	2
	DLW5ATH450TQ2K									
	DLW5ATH450TQ2B									
	DLW5ATH111TQ2L	12	110							
	DLW5ATH111TQ2K									
	DLW5ATH111TQ2B									
	DLW5ATH231TQ2L	22	230							
	DLW5ATH231TQ2K									
	DLW5ATH231TQ2B									
	DLW5ATH401TQ2L	35	400							
	DLW5ATH401TQ2K									
	DLW5ATH401TQ2B									
	DLW5ATH501TQ2L	55	500							
	DLW5ATH501TQ2K									
	DLW5ATH501TQ2B									

(\*)As for DLW5ATH\_TQ type Rated Current is derated as following figure depending on the operating temperature.

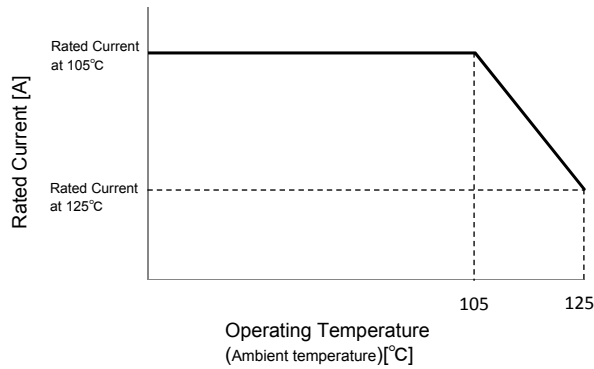

• Operating Temperature : - 40 °C to + 125 °C      • Storage Temperature : - 40 °C to + 125 °C

### 4. Standard Testing Conditions

< Unless otherwise specified >

Temperature : Ordinary Temp. 15 °C to 35 °C

Humidity : Ordinary Humidity 25 %(RH) to 85 %(RH)

< In case of doubt >

Temperature : 20 °C ± 2 °C

Humidity : 60 %(RH) to 70 %(RH)

Atmospheric pressure : 86 kPa to 106 kPa

### 5. Style and Dimensions

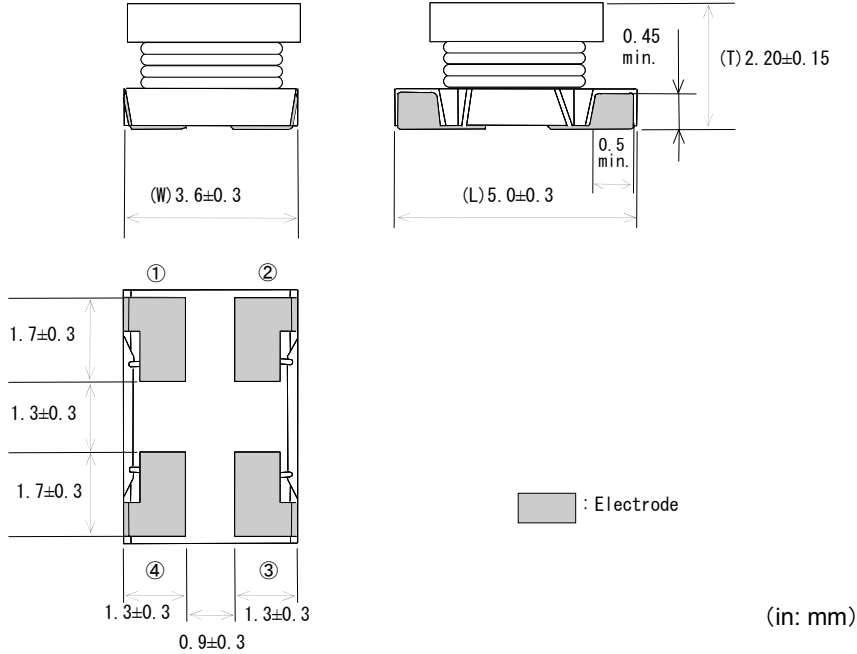

#### Equivalent Circuits

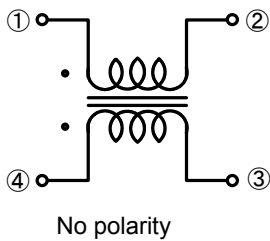

#### Unit Mass (Typical value)

0.14g

### 6. Marking

No marking.

### 7. Electrical Performance

No.	Item	Specifications	Test Method
7.1	Impedance ( Z ) (at 10MHz)	Meet item 3.	Measuring Equipment : KEYSIGHT 4191A or the equivalents. Measuring Frequency : 10MHz (ref. Item 9.)
7.2	Insulation Resistance (I.R.)		Measuring Equipment : R8340A or the equivalents. Measuring voltage : Rated Voltage Time : within 60 s (ref. Item 9.)
7.3	DC Resistance (Rdc)		Measuring Current : 100 mA max. (ref. Item 9.) (In case of doubt in the above mentioned standard condition,measure by 4 terminal method.)
7.4	Withstanding Voltage	Products shall not be damaged.	Test Voltage : 2.5 times for Rated Voltage Time : 1 to 5 seconds Charge Current : 1 mA max. (ref. Item 9.)

# Reference Only

## 8. Q200 Requirement

### 7-1. Performance (based on Table 13 for Ferrite EMI SUPPRESSORS/FILTERS)

**AEC-Q200 Rev.D issued June 1. 2010**

AEC-Q200			Murata Specification / Deviation								
No.	Stress	Test Method									
3	High Temperature Exposure	1000hours at 125 deg C Set for 24hours at room temperature, then measured.	Meet Table A after testing. Table A <table border="1" style="margin-left: 20px; border-collapse: collapse;"> <tr> <td style="padding: 2px;">Appearance</td> <td style="padding: 2px;">No damaged.</td> </tr> <tr> <td style="padding: 2px;">Impedance change (at 10MHz)</td> <td style="padding: 2px;">within ± 20%</td> </tr> <tr> <td style="padding: 2px;">I.R.</td> <td style="padding: 2px;">10MΩ min.</td> </tr> <tr> <td style="padding: 2px;">Withstanding Voltage</td> <td style="padding: 2px;">No damaged.</td> </tr> </table>	Appearance	No damaged.	Impedance change (at 10MHz)	within ± 20%	I.R.	10MΩ min.	Withstanding Voltage	No damaged.
Appearance	No damaged.										
Impedance change (at 10MHz)	within ± 20%										
I.R.	10MΩ min.										
Withstanding Voltage	No damaged.										
4	Temperature Cycling	1000cycles -40 deg C to +125 deg C Set for 24hours at room temperature, then measured.	Meet Table A after testing.								
5	Destructive Physical Analysis	Per EIA469 No electrical tests	Not Applicable								
7	Biased Humidity	1000hours at 85 deg C, 85%RH Apply max rated voltage and current.	Meet Table A after testing. Apply rated voltage. <span style="float: right;">(ref.item 9)</span>								
8	Operational Life	Apply 125 deg C 1000hours Set for 24hours at room temperature, then measured	Meet Table A after testing. Apply derating of rated current. <span style="float: right;">(ref.item 9)</span>								
9	External Visual	Visual inspection	No abnormalities								
10	Physical Dimension	Meet ITEM 5 (Style and Dimensions)	No defects								
12	Resistance to Solvents	Per MIL-STD-202 Method 215	Not Applicable								
13	Mechanical Shock	Per MIL-STD-202 Method 213 Conditon F: 1500g's(14.7N)/0.5ms/ Half sine	Meet Table A after testing.								
14	Vibration	5g's(0.049N) for 20 minutes, 12cycles each of 3 orientations Test from 10-2000Hz. 12cycles each of 3 orientations	Meet Table A after testing.								
15	Resistance to Soldering Heat	No-heating Solder temperature 260C+/-5 deg C Immersion time 10s	Pre-heating : 150 C / 60s min. Meet Table A after testing.								
17	ESD	Per AEC-Q200-002	Meet Table A after testing. ESD Rank: Refer to Item 3. Rating.								
18	Solderbility	Per J-STD-002	Method b : Not Applicable 90% of the terminations is to be soldered. (except partly-exposed wire) Flux:Ethanol solution of rosin,25(wt)% includes activator equivalent to 0.06 to 0.10(wt)% chlorine								
19	Electrical Characterization	Measured : Impedance	No defects								

# Reference Only

AEC-Q200			Murata Specification / Deviation
No.	Stress	Test Method	
20	Flammability	Per UL-94	Not Applicable
21	Board Flex	Epoxy-PCB(1.6mm) Deflection 2mm(min) 60 sec minimum holding time	Meet Table A after testing. 30 sec minimum holding time
22	Terminal Strength	Per AEC-Q200-006 A force of 17.7N for 60sec	No defects
30	Electrical Transient Conduction	Per ISO-7637-2	Not Applicable

**9. Terminal to be Tested** When measuring and supplying the voltage, the following terminal is applied.

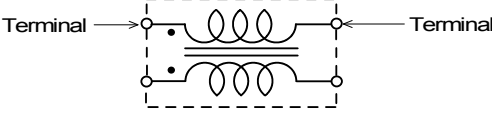
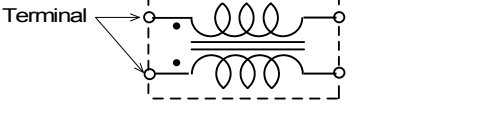
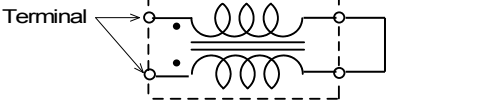
No.	Item	Terminal to be Tested
9.1	Impedance ( Z ) (Measurement Terminal)	
9.2	DC Resistance (R <sub>dc</sub> ) (Measurement Terminal)	
9.3	Insulation Resistance (I.R.) (Measurement Terminal)	
9.4	Withstanding Voltage (Measurement Terminal)	
9.5	Biased Humidity (Supply Terminal)	
9.6	Operational Life (Supply Terminal)	

**10. Impedance Frequency Characteristics (Typical)**

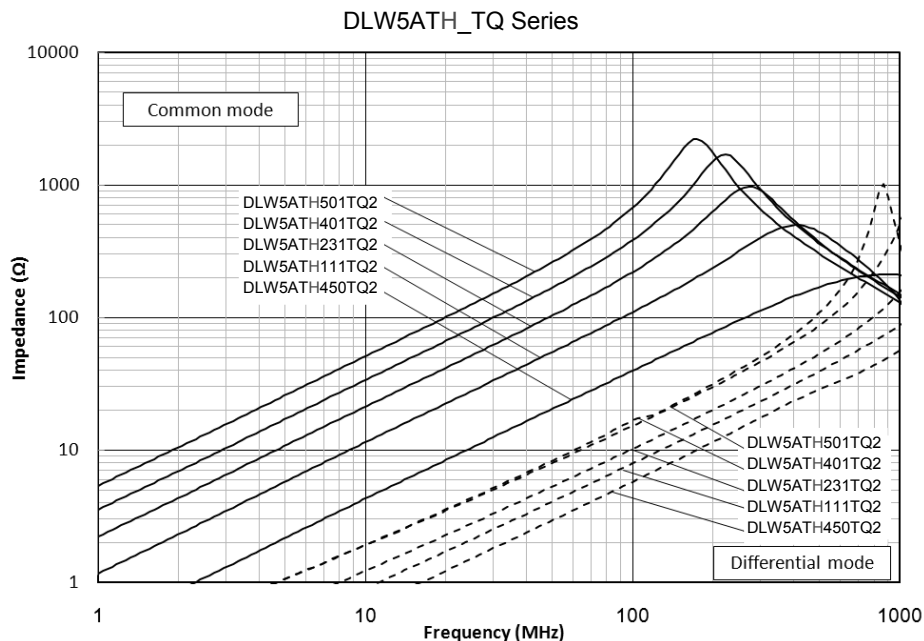

**11. P.C.B., Flux, Solder and Soldering condition**

Test shall be done using P.C.B., Flux, Solder and Soldering condition which are specified in item 14 except the case of being specified special condition.

## 12. Specification of Packaging

### 12.1 Appearance and Dimensions

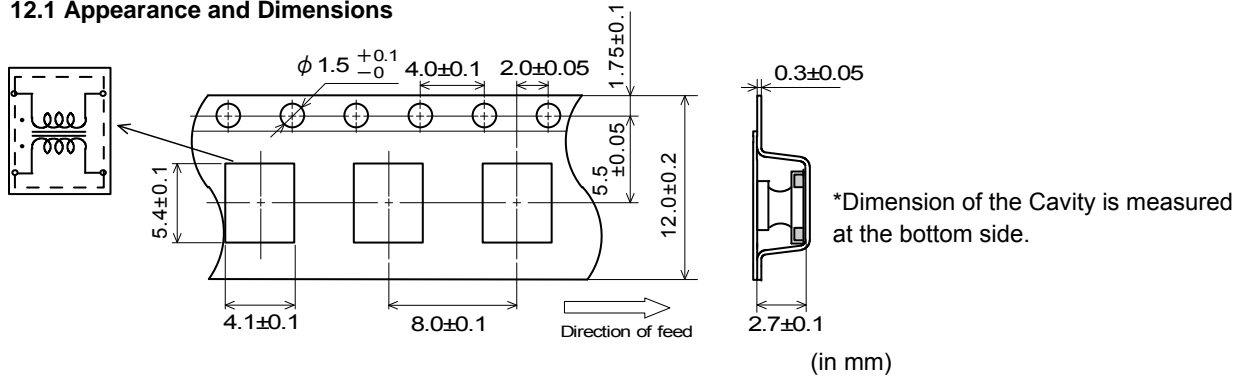

### 12.2 Specification of Taping

- (1) Packing quantity (Standard quantity)  $\phi 180$  mm reel : 700 pcs. / reel  $\phi 330$  mm reel : 2500 pcs. / reel
- (2) Packing Method  
Products shall be packaged in each embossed cavity of plastic tape and sealed with cover tape.
- (3) Sprocket Hole  
The sprocket holes are to the right as the tape is pulled toward the user.
- (4) Spliced point  
The cover tape have no spliced point.
- (5) Missing components number  
Missing components number within 0.1% of the number per reel or 1 pc., whichever is greater, and are not continuous. The specified quantity per reel is kept.

### 12.3 Pull Strength of Plastic Tape

Plastic Tape	5 N min.
Cover Tape	10 N min.

### 12.4 Peeling off force of Cover Tape

0.2N to 0.7N (minimum value is typical.)  
Speed of Peeling off : 300 mm / min

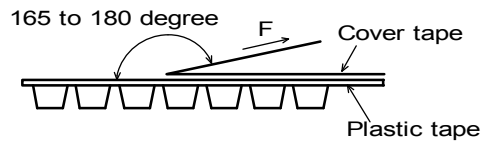

### 12.5 Dimensions of Leader-tape, Trailer and Reel

There shall be leader-tape (cover tape only and empty tape) and trailer-tape (empty tape) as follows.

« Packaging Code : L ( $\phi 180$ mm reel) »

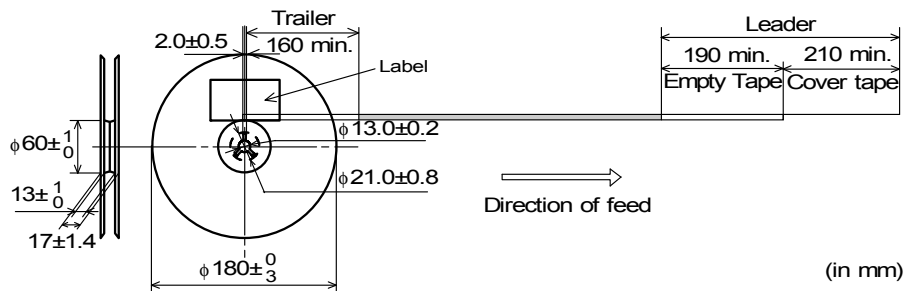

« Packaging Code : K ( $\phi 330$ mm reel) »

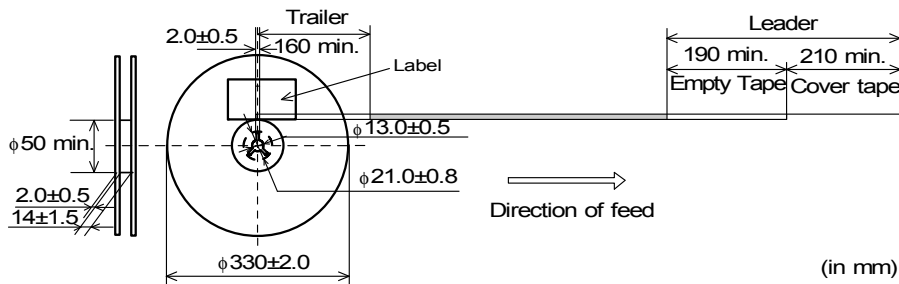



## 14. Notice

This product is designed for solder mounting.  
Please consult us in advance for applying other mounting method such as conductive adhesive.

### 14.1 Flux and Solder

Flux	Use rosin-based flux,(with converting chlorine content 0.06 to 0.1(wt)% ), but not highly acidic flux (with Halogen content exceeding 0.2(wt)% conversion to chlorine). Do not use water-soluble flux.
Solder	Use Sn-3.0Ag-0.5Cu solder

### 14.2 Assembling

< Exclusive use of Reflow soldering >

Flow soldering may cause deterioration in insulation resistance.  
So, reflow soldering shall be applied for this product.

< Thermal Shock >

Pre-heating should be in such a way that the temperature difference between solder and ceramic surface is limited to 100°C max. Also cooling into solvent after soldering should be in such a way that the temperature difference is limited to 100°C max.  
Not enough preheating may cause deterioration in insulation resistance and / or crack or ceramic body.

### 14.3 Cleaning Conditions

Do not clean after soldering. If cleaning, please contact us.

### 14.4 Resin coating

The impedance value may change due to high cure-stress of resin to be used for coating/molding products. An open circuit issue may occur by mechanical stress caused by the resin, amount/cured shape of resin, or operating condition etc. Some resin contains some impurities or chloride possible to generate chlorine by hydrolysis under some operating condition may cause corrosion of wire of coil, leading to open circuit. So, please pay your careful attention when you select resin in case of coating/molding the products with the resin. Prior to use the coating resin, please make sure no reliability issue is observed by evaluating products mounted on your board.

### 14.5 Attention regarding P.C.B. bending

The following shall be considered when designing and laying out P.C.B.'s.

(1) P.C.B. shall be designed so that products are not subject to the mechanical stress due to warping the board.

[Products direction]

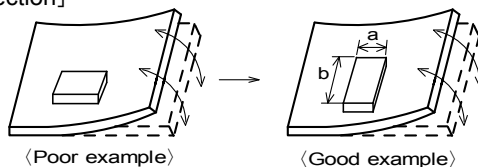

Products shall be location the sideways direction (Length:a<b) to the mechanical stress.

(2) Components location on P.C.B. separation.

It is effective to implement the following measures, to reduce stress in separating the board.

It is best to implement all of the following three measures; however, implement as many measures as possible to reduce stress.

Contents of Measures	Stress Level
(1) Turn the mounting direction of the component parallel to the board separation surface.	A > D *1
(2) Add slits in the board separation part.	A > B
(3) Keep the mounting position of the component away from the board separation surface.	A > C

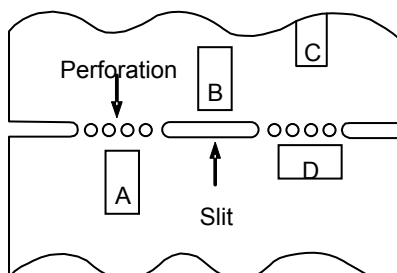

\*1 A > D is valid when stress is added vertically to the perforation as with Hand Separation. If a Cutting Disc is used, stress will be diagonal to the PCB, therefore A > D is invalid.

### (3) Mounting Components Near Screw Holes

When a component is mounted near a screw hole, it may be affected by the board deflection that occurs during the tightening of the screw. Mount the component in a position as far away from the screw holes as possible.

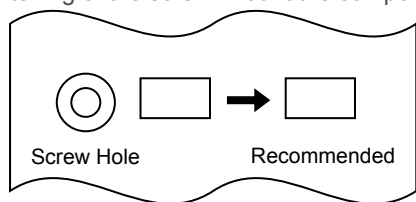

## 14.6 Attention Regarding P.C.B. Design

### < The Arrangement of Products >

- P.C.B. shall be designed so that products are far from the portion of perforation.
- The portion of perforation shall be designed as narrow as possible, and shall be designed so as not to be applied the stress in the case of P.C.B. separation.

- Products shall not be arranged on the line of a series of holes when there are big holes in P.C.B.  
(Because the stress concentrate on the line of holes.)

### < Products Placing >

- Support pins shall be set under P.C.B. to prevent causing a warp to P.C.B. during placing the products on the other side of P.C.B..

### < P.C.B. Separation >

- P.C.B. shall not be separated with hand.  
P.C.B. shall be separated with the fixture so as not to cause P.C.B. bending.

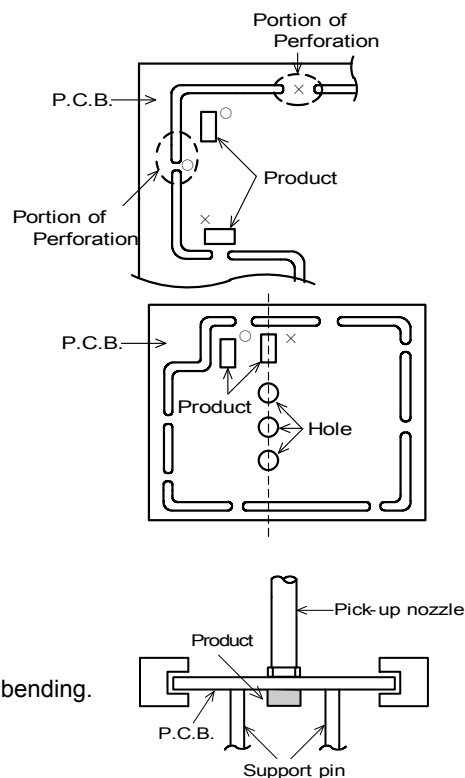

## 14.7 Standard Land Dimensions

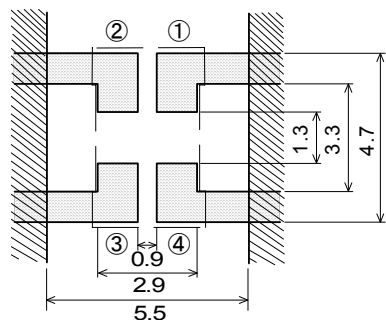

\*①②③④ indicates terminal number.

- Resist
- Copper foil pattern
- No pattern

(in mm)

## 14.8 Reflow Soldering

### (1) Standard printing pattern of solder paste

- Standard thickness of solder paste should be 150 to 200 $\mu$ m.  
Solderability is subject to reflow condition and thermal conductivity.  
Please make sure that your product has been evaluated in view of your specifications with our product being mounted to your product.
- Use the solder paste printing pattern of the right pattern.
- For the resist and copper foil pattern, use standard land dimensions.
- Use the Solder Sn-3.0Ag-0.5Cu for pattern printing.

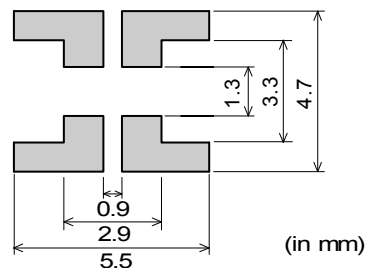

(in mm)



**(2) Soldering Conditions**

Standard soldering profile and the limit soldering profile is as follows.

The excessive soldering conditions may cause leaching of the electrode and/or resulting in the deterioration of product quality.

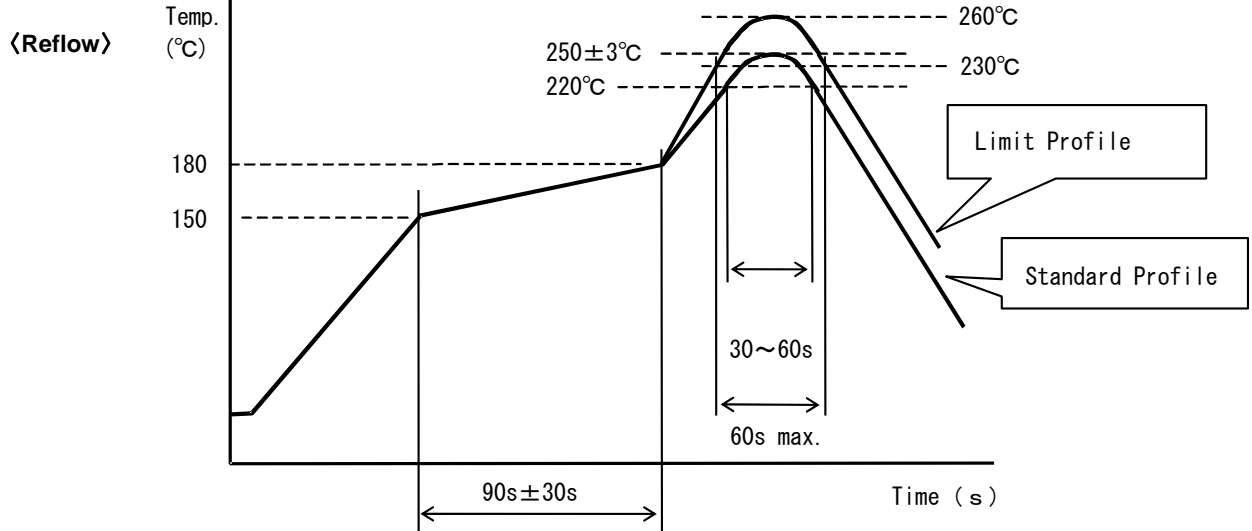

	Standard Profile	Limit Profile
Pre-heating	150~180°C、90s±30s	
Heating	above 220°C、30s~60s	above 230°C、60s max.
Peak temperature	250±3°C	260°C, 10s
Cycle of reflow	2 times	2 times

**14.9 Reworking with Soldering iron**

The following conditions must be strictly followed when using a soldering iron after being mounted by reflow soldering.

- Pre-heating: 150°C, 1 min
- Tip temperature: 350°C max.
- Soldering time : 3(+1,-0) seconds.
- Soldering iron output: 30W max.
- Tip diameter:φ3mm max.
- Times : 2times max.

Notes: Do not touch the products directly with the soldering iron.

**14.10 Handling of a substrate**

After mounting products on a substrate, do not apply any stress to the product caused by bending or twisting to the substrate when cropping the substrate, inserting and removing a connector from the substrate or tightening screw to the substrate.

Excessive mechanical stress may cause cracking in the product.

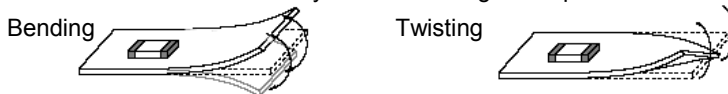

**14.11 Brushing of neighborhood of products**

When you clean the neighborhood of products such as connector pins, bristles of cleaning brush shall not be touched to the winding portion to prevent the breaking of wire.

**14.12 Operating Environment**

Do not use this product under the following environmental conditions, on deterioration of the performance, such as insulation resistance may result from the use.

- (1) in corrosive gases (acidic gases, alkaline gases, chlorine, sulfur gases, organic gases and etc.)
- (2) in the atmosphere where liquid such as organic solvent, may splash on the products.

## 14.13 Storage condition

### (1) Storage period

Use the products within 12 months after delivered.

Solderability should be checked if this period is exceeded.

### (2) Storage environment conditions

• Products should be stored in the warehouse on the following conditions.

Temperature : -10 °C to +40 °C

Humidity : 15 % to 85% relative humidity No rapid change on temperature and humidity.

• Products should not be stored in corrosive gases, such as sulfurous, acid gases, alkaline gases, to prevent the following deterioration.

Poor solderability due to the oxidized electrode.

• Products should be stored on the palette for the prevention of the influence from humidity, dust and so on.

• Products should be stored in the warehouse without heat shock, vibration, direct sunlight and so on.

• Products should not be stored under the air tight packaged condition.

### (3) Delivery

Care should be taken when transporting or handling product to avoid excessive vibration or mechanical shock.

## 15. Note

(1) Please make sure that your product has been evaluated in view of your specifications with our product being mounted to your product.

(2) You are requested not to use our product deviating from the reference specifications.

(3) The contents of this reference specification are subject to change without advance notice. Please approve our product specifications or transact the approval sheet for product specifications before ordering.