

PXD20-xxSxx Single Output DC/DC Converter

9 to 18 , 18to 36 and 36 to75 Vdc input, 1.5to 15 Vdc Single Output, 20W

TDK-Lambda



Features

- Low profile: 2.0X1.0X0.4 inches (50.8X25.4X10.2mm)
- 2:1 wide input voltage of 9-18, 18-36 and 36-75VDC
- 20 Watts output power
- Input to output isolation: 1600Vdc, min
- Operating case temperature range :100°C max
- Over-current protection, auto-recovery
- Output over voltage protection
- ISO 9001 certified manufacturing facilities
- UL60950-1, EN60950-1 and IEC60950-1 licensed
- CE Mark meet 2006/95/EC, 93/68/EEC and 2004/108/EC
- Compliant to RoHS EU directive 2002/95/EC

Applications

- Distributed power architectures
- Communication equipment
- Computer equipment

Option

- Negative logic Remote on/off

General Description

The PXD20-xxSxx series offers 20 watts of output power from a 2 x 1 x 0.4 inch package.

Table of contents

Absolute maximum rating	P2	External trim adjustment	P9
Input Specifications	P2	Characteristic curves	P11
General Specifications	P3	Test configurations	P20
Output Specifications	P4	Part number structure	P21
Thermal Consideration	P5	Mechanical data	P21
Output over current protection	P7	Safety and installation instruction	P22
Short circuit protection	P7	MTBF and Reliability	P22
Solder and Reflow consideration	P8		

Absolute Maximum Rating						
Parameter		Device	Min	Typ	Max	Unit
Input Voltage	Continuous	12Sxx			18	Vdc
		24Sxx			36	Vdc
		48Sxx			75	Vdc
	Transient (100ms)	12Sxx			36	Vdc
		24Sxx			50	Vdc
		48Sxx			100	Vdc
Operating temperature range (Operating temperature will be depended De-rating curve)		All	-40		+85	°C
Operating case range		All			100	°C
Storage temperature		All	-55		+105	°C
I/O Isolation voltage		All	1600			Vdc
I/O Isolation capacitance		All			1000	pF

Input Specifications						
Parameter		Device	Min	Typ	Max	Unit
Operating Input Voltage		12Sxx	9	12	18	Vdc
		24Sxx	18	24	36	Vdc
		48Sxx	36	48	75	Vdc
Input reflected ripple current (Please see the testing configurations part.)		All		20		mAp-p
Start Up Time (nominal vin and constant resistive load)	Power up	All		10		mS
	Remove on/off					
Remote ON/OFF						
Positive Logic	DC-DC ON	All	3		12	Vdc
	DC-DC OFF	All	0		1.2	Vdc
Negative Logic (Option)	DC-DC ON	All	0		1.2	Vdc
	DC-DC OFF	All	3		12	Vdc

General Specifications					
Parameter	Device	Min	Typ	Max	Unit
Efficiency Test at Vin, nom and full load (Please see the testing configurations part.)	12S1P5		78		%
	12S1P8		79		%
	12S2P5		83		%
	12S3P3		85		%
	12S05		87		%
	12S12		86		%
	12S15		86		%
	24S1P5		80		%
	24S1P8		81		%
	24S2P5		84		%
	24S3P3		86		%
	24S05		89		%
	24S12		87		%
	24S15		87		%
	48S1P5		80		%
	48S1P8		82		%
	48S2P5		84		%
	48S3P3		87		%
48S05		89		%	
48S12		88		%	
48S15		87		%	
Isolation resistance	All	10^9			Ω
Transient Response Recovery Time (25% load step change)	All		250		μ S
Isolation Capacitance	All			1000	pF
Switching Frequency (Test at Vin, nom and full load)	All		500		KHz
Weight	All		27		g
MTBF (please see the MTBF and reliability part)	All		1.791×10^6		hours

Output Specifications					
Parameter	Device	Min	Typ	Max	Unit
Operating Output Range	xxS1P5	1.485	1.500	1.515	Vdc
	xxS1P8	1.782	1.800	1.818	Vdc
	xxS2P5	2.475	2.500	2.525	Vdc
	xxS3P3	3.267	3.300	3.333	Vdc
	xxS05	4.95	5.00	5.05	Vdc
	xxS12	11.88	12.00	12.12	Vdc
	xxS15	14.85	15.00	15.15	Vdc
Line Regulation(LL to HL at Full Load)	All	-0.2		0.2	%
Load Regulation(0% to 100% Full Load)	All	-0.5		0.5	%
Output Ripple & Noise, 20MHz bandwidth (Measured with a 0.1 μ F/50V MLCC)	xxS1P5		60		mVp-p
	xxS1P8		60		
	xxS2P5		60		
	xxS3P3		60		
	xxS05		75		
	xxS12		75		
	xxS15		75		
Temperature Coefficient	All	-0.02		+0.02	%/°C
Output Current	xxS1P5	0		6000	mA
	xxS1P8	0		6000	mA
	xxS2P5	0		6000	mA
	xxS3P3	0		5000	mA
	xxS05	0		4000	mA
	xxS12	0		1670	mA
	xxS15	0		1330	mA
Output Over Voltage Protection Zener diode clamp	xxS1P5		3.9		Vdc
	xxS1P8		3.9		Vdc
	xxS2P5		3.9		Vdc
	xxS3P3		3.9		Vdc
	xxS05		6.2		Vdc
	xxS12		15		Vdc
	xxS15		18		Vdc
Output Over Current Protection	All			150	% FL
Output Short Circuit Protection	All	Hiccup, automatic recovery			
Output Capacitor Load	xxS1P5			65000	μ F
	xxS1P8			65000	μ F
	xxS2P5			33000	μ F
	xxS3P3			13000	μ F
	xxS05			6800	μ F
	xxS12			2200	μ F
	xxS15			755	μ F

Thermal Consideration

The power module operates in a variety of thermal environments. However, sufficient cooling should be provided to help ensure reliable operation of the unit. Heat is removed by conduction, convection, and radiation to the surrounding environment. Proper cooling can be verified by measuring the point as indicated in the figure below. The temperature at this location should not exceed 100°C. When operating, adequate cooling must be provided to maintain the test point temperature at or below 100°C. Although the maximum temperature of the power module is 100°C, decreasing this temperature will yield higher reliability.

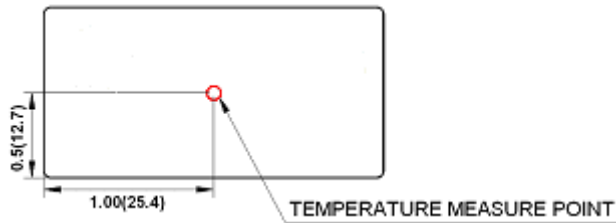

Measurement shown in inches(mm)

TOP VIEW

Following are derating curves for models: PXD20-24S1P8, 48S05 and 48S15.

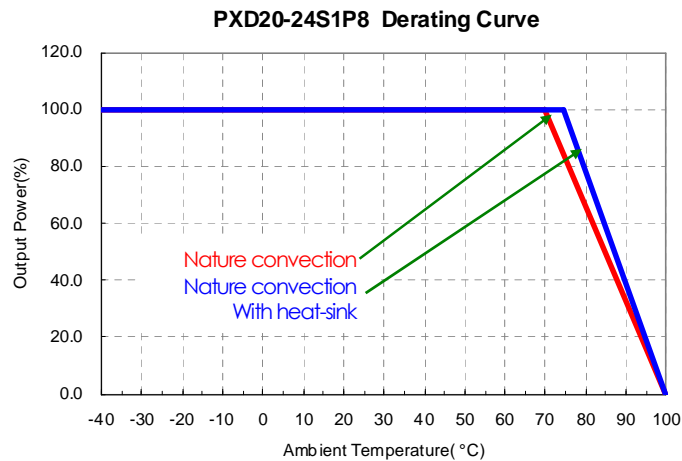

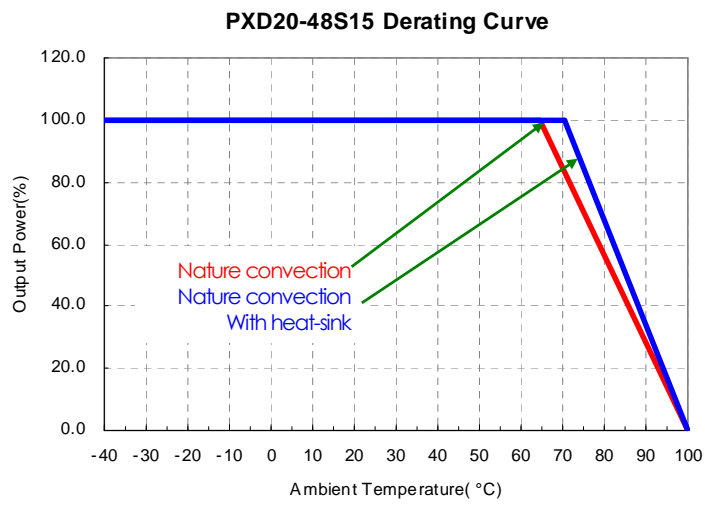
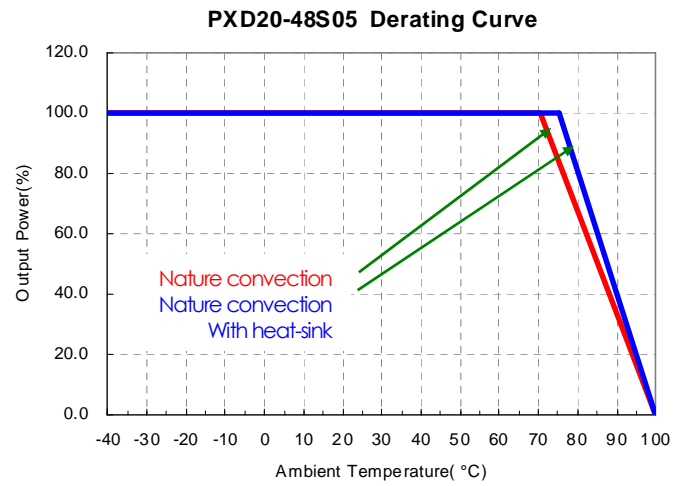

Output Over Current Protection

When excessive output currents occur in the system, circuit protection is required on all power supplies. Normally, overload current is maintained at approximately 150 percent of rated current for PxD20-xxSxx series.

Hiccup-mode is a method of operation in a power supply whose purpose is to protect the power supply from being damaged during an over-current fault condition. It also enables the power supply to restart when the fault is removed. There are other ways of protecting the power supply when it is over-loaded, such as the maximum current limiting or current foldback methods.

One of the problems resulting from over current is that excessive heat may be generated in power devices; especially MOSFET and Schottky diodes and the temperature of those devices may exceed their specified limits. A protection mechanism has to be used to prevent these power devices from being damaged.

The operation of hiccup is as follows. When the current sense circuit sees an over-current event, the controller shuts off the power supply for a given time and then tries to start up the power supply again. If the over-load condition has been removed, the power supply will start up and operate normally; otherwise, the controller will see another over-current event and shut off the power supply again, repeating the previous cycle. Hiccup operation has none of the drawbacks of the other two protection methods, although its circuit is more complicated because it requires a timing circuit. The excess heat due to overload lasts for only a short duration in the hiccup cycle, hence the junction temperature of the power devices is much lower.

The hiccup operation can be done in various ways. For example, one can start hiccup operation any time an over-current event is detected; or prohibit hiccup during a designated start-up interval (usually a few milliseconds). The reason for the latter operation is that during start-up, the power supply needs to provide extra current to charge up the output capacitor. Thus the current demand during start-up is usually larger than during normal operation and it is easier for an over-current event to occur. If the power supply starts to hiccup once there is an over-current, it might never start up successfully. Hiccup mode protection will give the best protection for a power supply against over current situations, since it will limit the average current to the load at a low level, so reducing power dissipation and case temperature in the power devices.

Short Circuitry Protection

Continuous, hiccup and auto-recovery mode.

During short circuit, the converter shuts down. The average current during this condition will be very low and the device is protected.

Soldering and Reflow Consideration

Lead free wave solder profile for PXD20-xxSxx DIP type

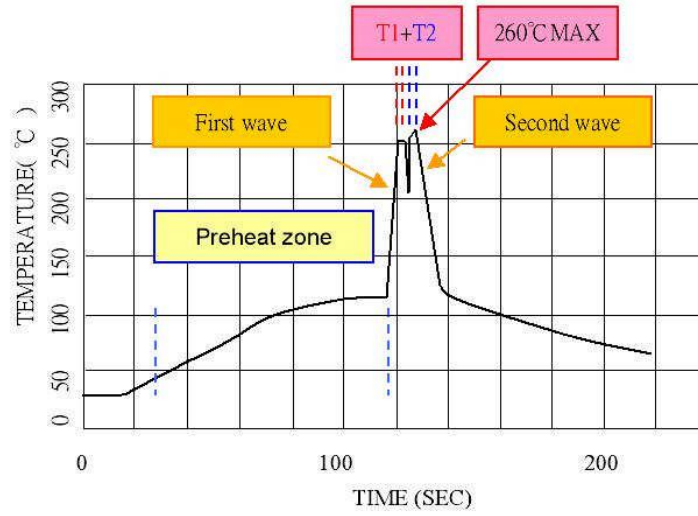

Zone	Reference Parameter
Preheat zone	Rise temp. speed : 3°C / sec max. Preheat temp. : 100~130°C
Actual heating	Peak temp. : 250~260°C Peak time (T1+T2 time) : 4~6 sec

Reference Solder: Sn-Ag-Cu/Sn-Cu

Hand Welding: Soldering iron- Power 90W

Welding Time: 2-4 sec

Temp.: 380-400 °C

External trim adjustment

Output voltage set point adjustment allows the user to increase or decrease the output voltage set point of a module. This is accomplished by connecting an external resistor between the TRIM pin and either the Vo (+) or Vo (-) pins. With an external resistor between the TRIM and Vo (+) pin, the output voltage set point decreases. With an external resistor between the TRIM and Vo (-) pin, the output voltage set point increases.

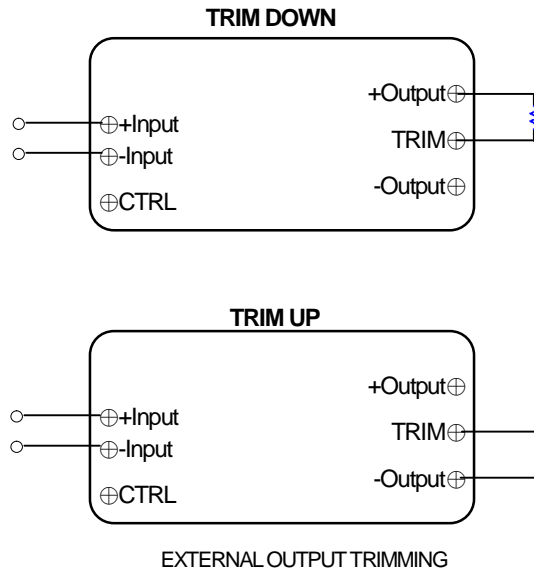

TRIM TABLE

PXD20-xxS1P5

Trim down	1	2	3	4	5	6	7	8	9	10	%
Vout=	1.485	1.470	1.455	1.440	1.425	1.410	1.395	1.380	1.365	1.350	Volts
Rx=	5.704	2.571	1.527	1.005	0.692	0.483	0.334	0.222	0.135	0.065	K Ohms
Trim up	1	2	3	4	5	6	7	8	9	10	%
Vout=	1.515	1.530	1.545	1.560	1.575	1.590	1.605	1.620	1.635	1.650	Volts
Rx=	4.578	2.065	1.227	0.808	0.557	0.389	0.270	0.180	0.110	0.054	K Ohms

PXD20-xxS1P8

Trim down	1	2	3	4	5	6	7	8	9	10	%
Vout=	1.782	1.764	1.746	1.728	1.710	1.692	1.674	1.656	1.638	1.620	Volts
Rx=	14.66	6.57	3.874	2.525	1.716	1.177	0.792	0.503	0.278	0.098	K Ohms
Trim up	1	2	3	4	5	6	7	8	9	10	%
Vout=	1.818	1.836	1.854	1.872	1.89	1.908	1.926	1.944	1.962	1.98	Volts
Rx=	11.639	5.205	3.060	1.988	1.344	0.915	0.609	0.379	0.200	0.057	K Ohms

PXD20-xxS2P5

Trim down	1	2	3	4	5	6	7	8	9	10	%
Vout=	2.475	2.450	2.425	2.400	2.375	2.350	2.325	2.300	2.275	2.250	Volts
Rx=	49.641	22.481	13.428	8.902	6.186	4.375	3.082	2.112	1.358	0.754	K Ohms
Trim up	1	2	3	4	5	6	7	8	9	10	%
Vout=	2.525	2.550	2.575	2.600	2.625	2.650	2.675	2.700	2.725	2.75	Volts
Rx=	37.076	16.675	9.874	6.474	4.434	3.074	2.102	1.374	0.807	0.354	K Ohms

PXD20-xxS3P3

Trim down	1	2	3	4	5	6	7	8	9	10	%
Vout=	3.267	3.234	3.201	3.168	3.135	3.102	3.069	3.036	3.003	2.970	Volts
Rx=	69.470	31.235	18.490	12.117	8.294	5.745	3.924	2.559	1.497	0.647	K Ohms
Trim up	1	2	3	4	5	6	7	8	9	10	%
Vout=	3.333	3.366	3.399	3.432	3.465	3.498	3.531	3.564	3.597	3.630	Volts
Rx=	57.930	26.165	15.577	10.283	7.106	4.988	3.476	2.341	1.459	0.753	K Ohms

PXD20-xxS05

Trim down	1	2	3	4	5	6	7	8	9	10	%
Vout=	4.950	4.900	4.850	4.800	4.750	4.700	4.650	4.600	4.550	4.500	Volts
Rx=	45.533	20.612	12.306	8.152	5.660	3.999	2.812	1.922	1.230	0.676	K Ohms
Trim up	1	2	3	4	5	6	7	8	9	10	%
Vout=	5.050	5.100	5.150	5.200	5.250	5.300	5.350	5.400	5.450	5.500	Volts
Rx=	36.570	16.580	9.917	6.585	4.586	3.253	2.302	1.588	1.032	0.588	K Ohms

PXD20-xxS12

Trim down	1	2	3	4	5	6	7	8	9	10	%
Vout=	11.880	11.760	11.640	11.520	11.400	11.280	11.160	11.040	10.920	10.800	Volts
Rx=	460.990	207.950	123.600	81.423	56.118	39.249	27.199	18.162	11.132	5.509	K Ohms
Trim up	1	2	3	4	5	6	7	8	9	10	%
Vout=	12.120	12.240	12.360	12.480	12.600	12.720	12.840	12.960	13.080	13.200	Volts
Rx=	367.910	165.950	98.636	64.977	44.782	31.318	21.701	14.488	8.879	4.391	K Ohms

PXD20-xxS15

Trim down	1	2	3	4	5	6	7	8	9	10	%
Vout=	14.850	14.700	14.550	14.400	14.250	14.100	13.950	13.800	13.650	13.500	Volts
Rx=	499.820	223.410	131.270	85.204	57.563	39.136	25.974	16.102	8.424	2.282	K Ohms
Trim up	1	2	3	4	5	6	7	8	9	10	%
Vout=	15.150	15.300	15.450	15.600	15.750	15.900	16.050	16.200	16.350	16.500	Volts
Rx=	404.180	180.590	106.060	68.796	46.437	31.531	20.883	12.898	6.687	1.718	K Ohms

Characteristic Curve

Efficiency

a. Efficiency with load change under different line conditions at room temperature

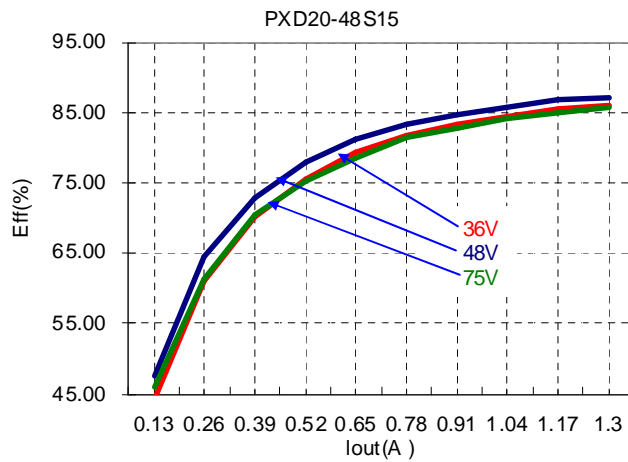
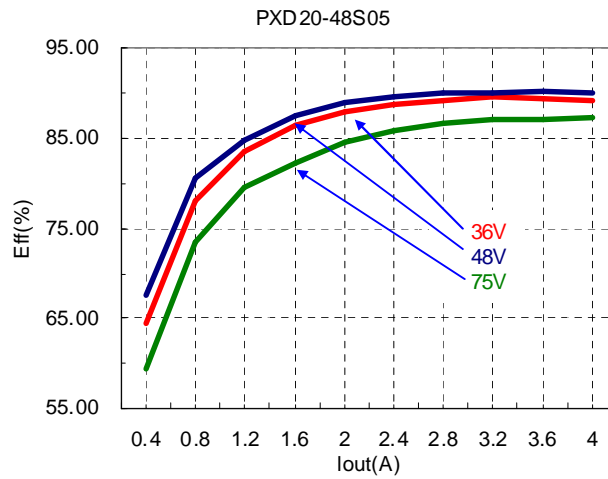
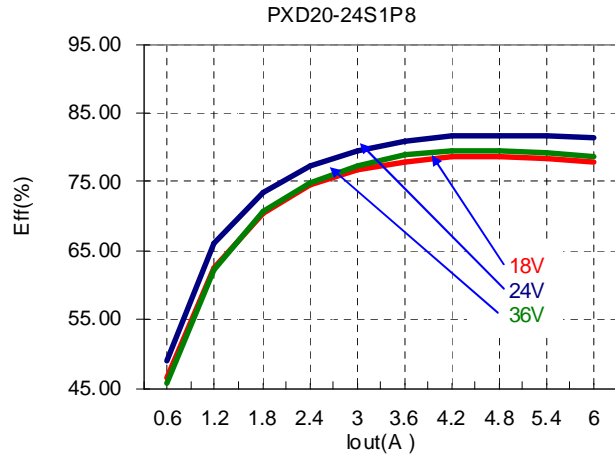

b. Efficiency with line change under different load conditions at room temperature

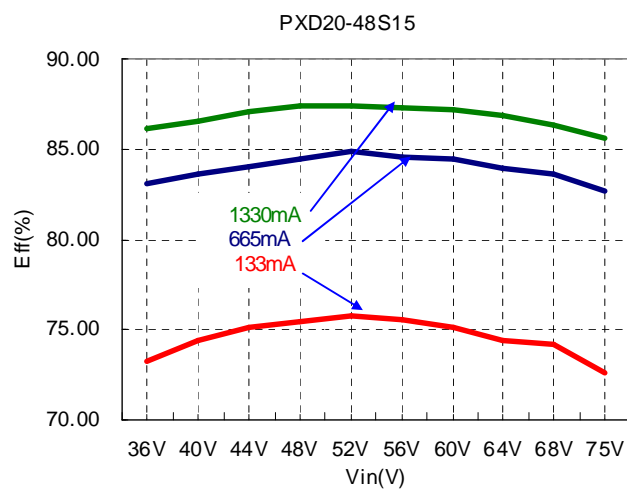
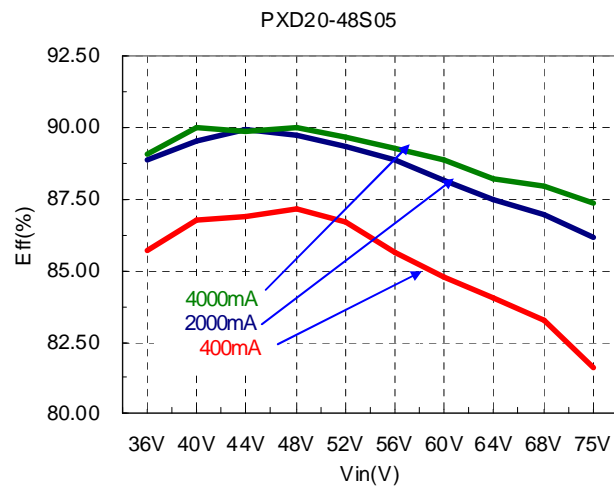
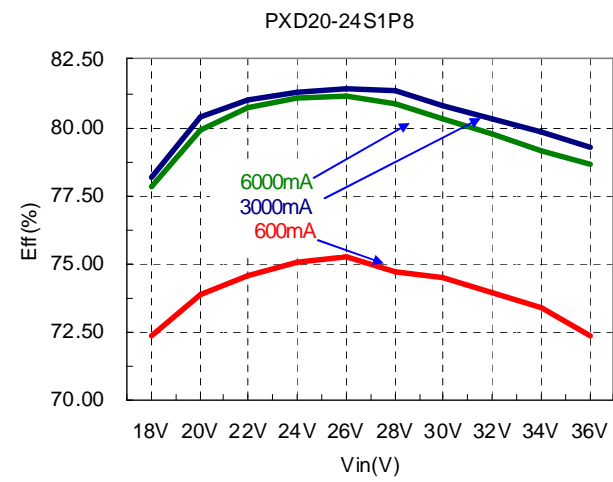

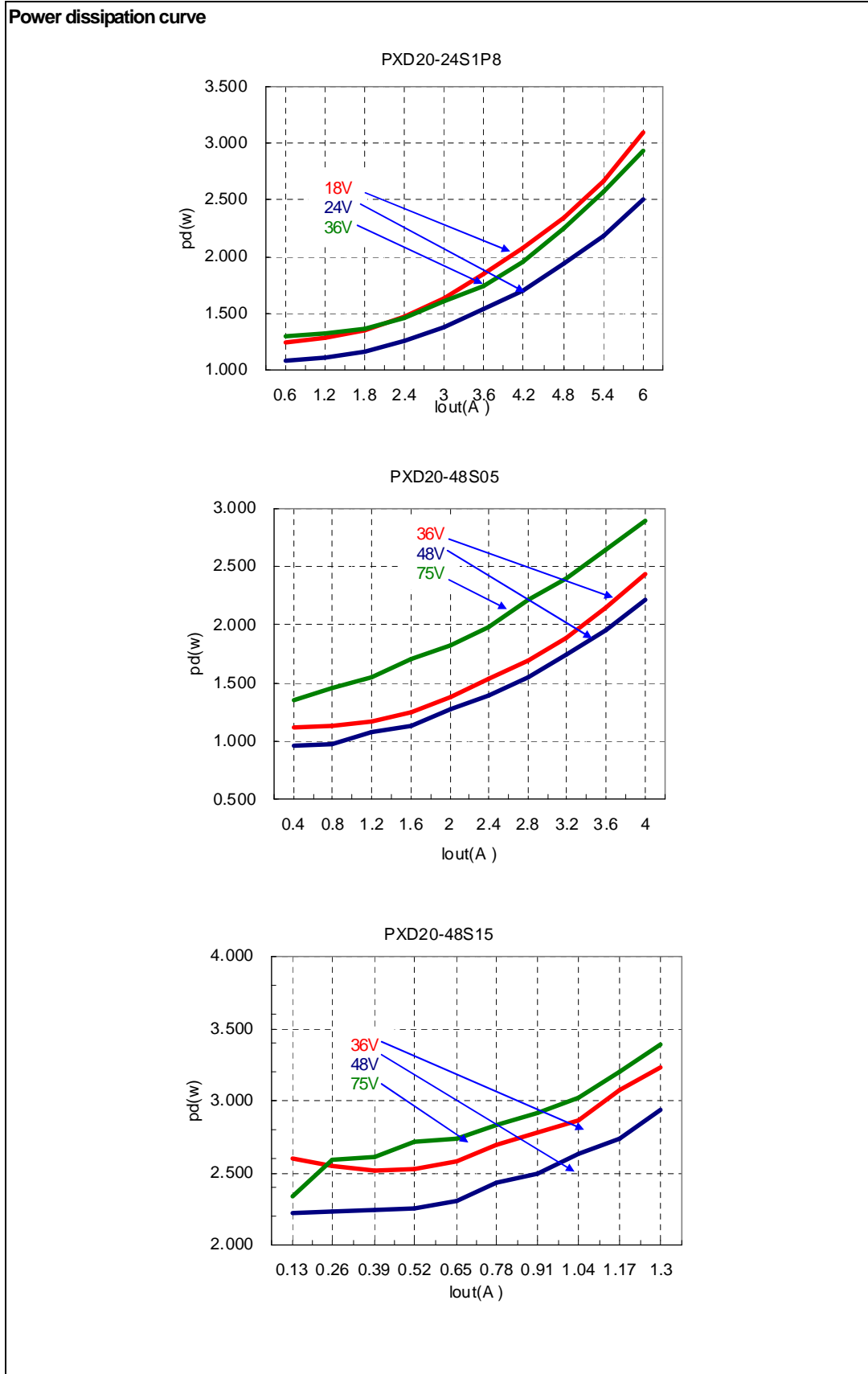

Output ripple & noise

PXD20-24S1P8

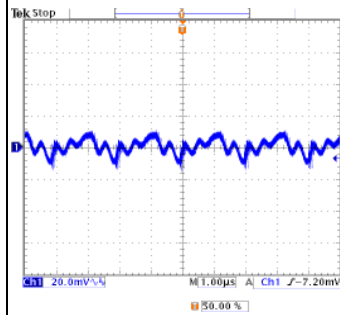

Low Line, Full Load
Output Ripple Noise=24.4mV

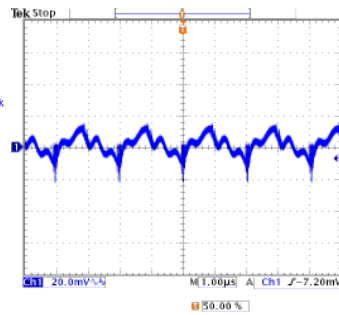

Normal Line, Full Load
Output Ripple Noise=36.4mV

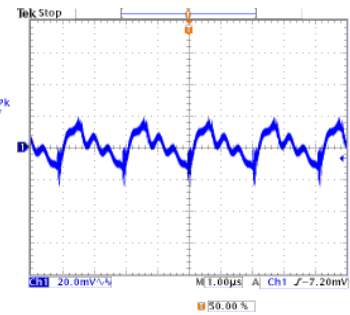

High Line, Full Load
Output Ripple Noise=42.4mV

PXD20-48S05

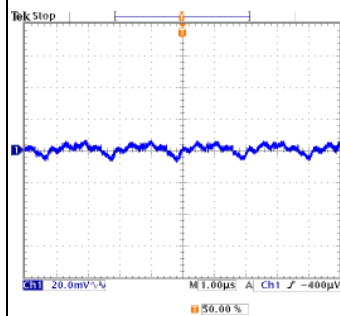

Low Line, Full Load
Output Ripple Noise=14.0mV

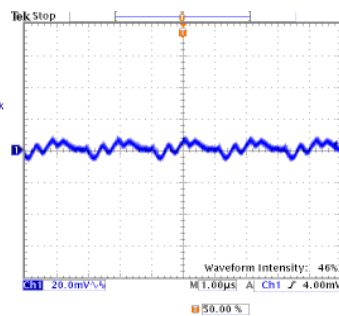

Normal Line, Full Load
Output Ripple Noise=16.4mV

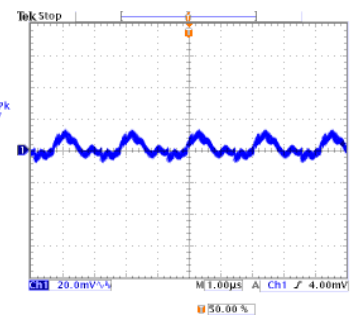

High Line, Full Load
Output Ripple Noise=20.8mV

PXD20-48S15

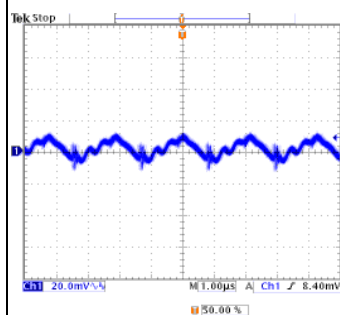

Low Line, Full Load
Output Ripple Noise=24.0mV

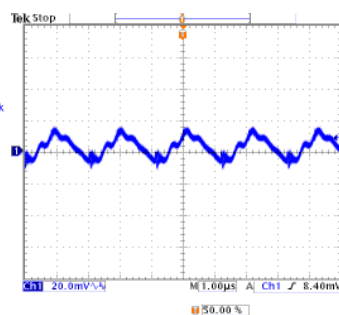

Normal Line, Full Load
Output Ripple Noise=25.7mV

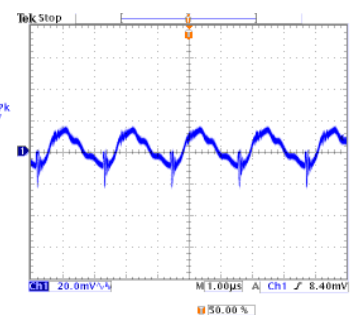

High Line, Full Load
Output Ripple Noise=37.6mV

Transient Peak and Response

PXD20-24S1P8

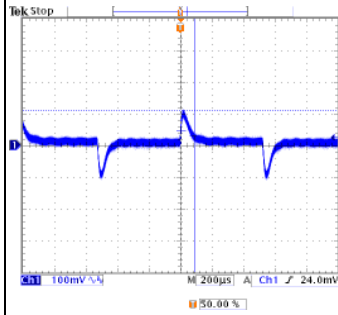

Low Line, Full Load
 Transient Peak 110.0mV
 Transient Response 84µs

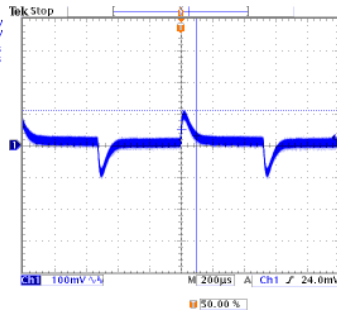

Normal Line, Full Load
 Transient Peak 108.0mV
 Transient Response 96µs

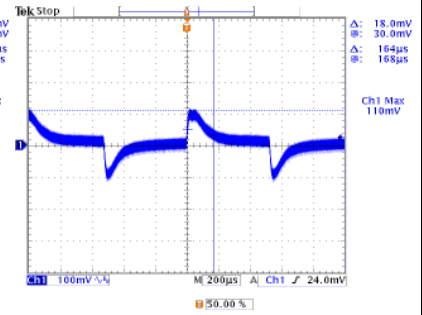

High Line, Full Load
 Transient Peak 110.0mV
 Transient Response 164µs

PXD20-48S05

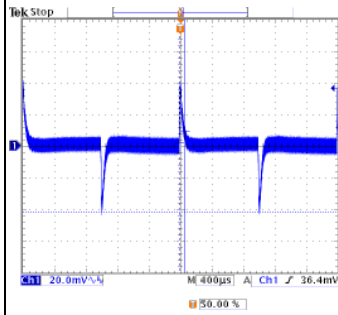

Low Line, Full Load
 Transient Peak 42mV
 Transient Response 72µs

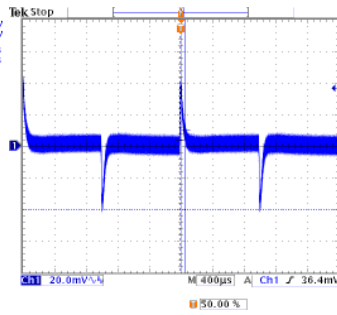

Normal Line, Full Load
 Transient Peak 40.8mV
 Transient Response 72µs

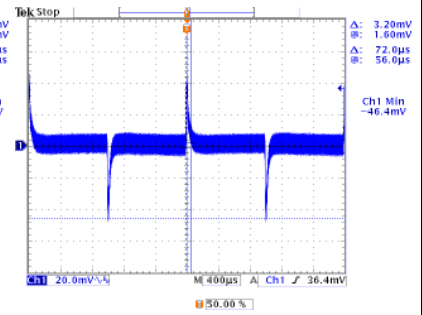

High Line, Full Load
 Transient Peak 46.4mV
 Transient Response 72µs

PXD20-48S15

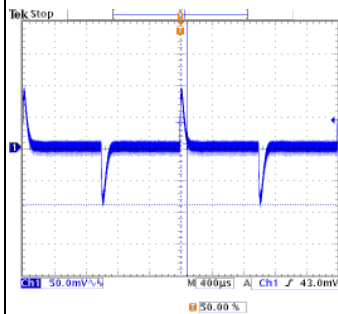

Low Line, Full Load
 Transient Peak 91mV
 Transient Response 88µs

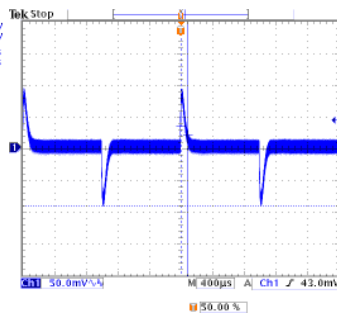

Normal Line, Full Load
 Transient Peak 93mV
 Transient Response 88µs

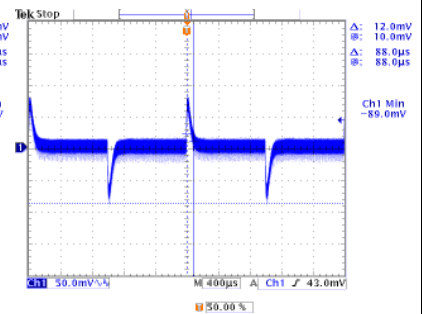

High Line, Full Load
 Transient Peak 89mV
 Transient Response 88µs

Inrush Current

PXD20-24S1P8

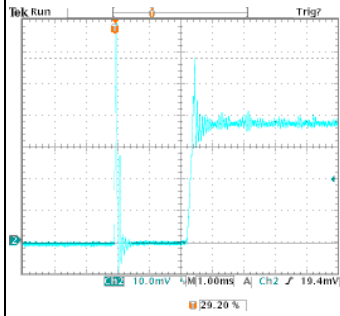

Low Line, Full Load
Inrush current=(58.4/10) X200mA=1168mA

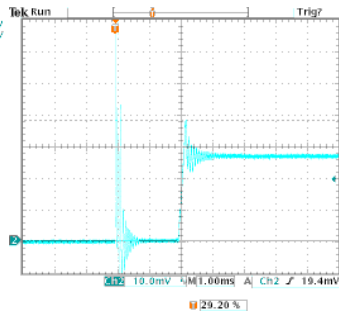

Normal Line, Full Load
Inrush current=(38.0/10) x200mA=760mA

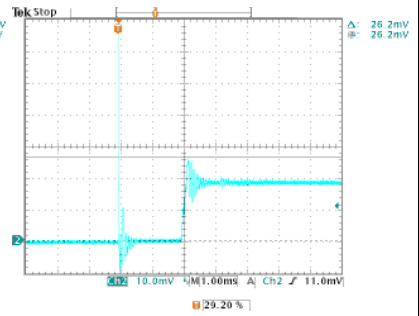

High Line, Full Load
Inrush current=(26.2/10) x200mA=524mA

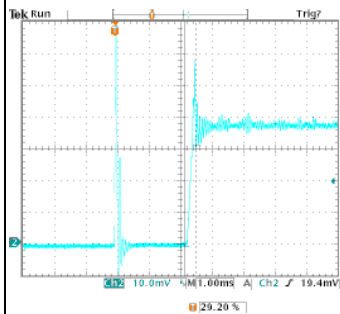

Low Line, Full Load
Duration: 360uS

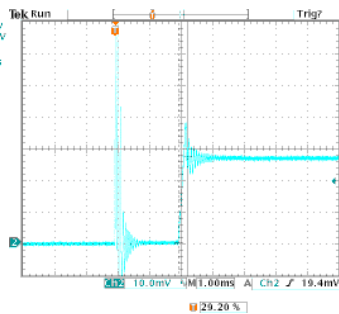

Normal Line, Full Load
Duration: 280uS

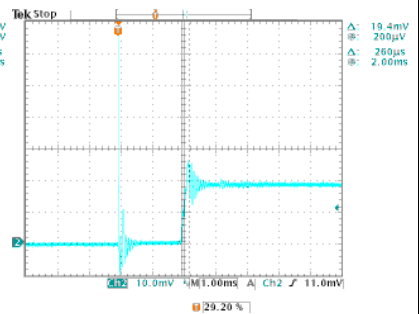

High Line, Full Load
Duration: 260uS

PXD20-48S05

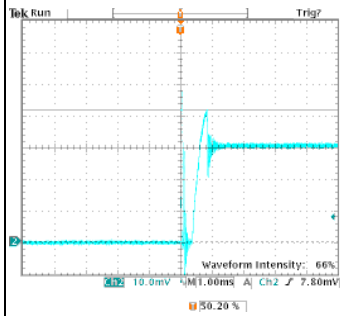

Low Line, Full Load
Inrush current=(41.6/10) X200mA=832mA

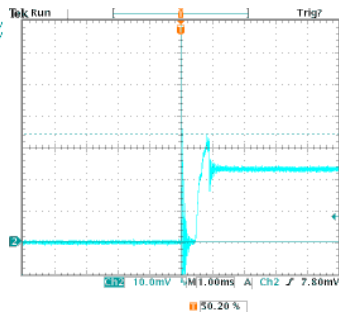

Normal Line, Full Load
Inrush current=(33.8/10) x200mA=676mA

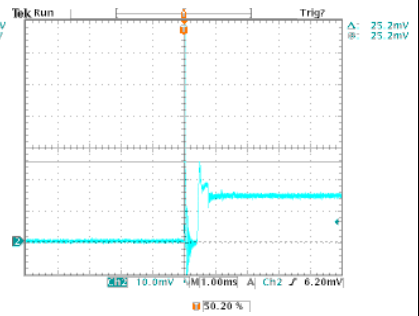

High Line, Full Load
Inrush current=(25.2/10) x200mA=504mA

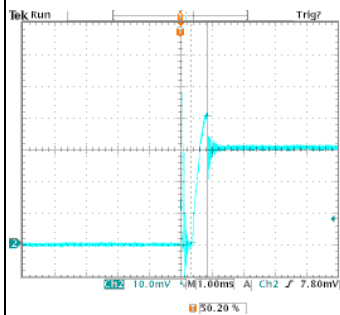

Low Line, Full Load
Duration: 520uS

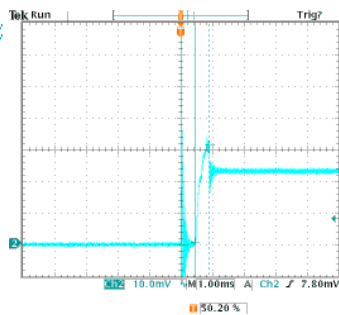

Normal Line, Full Load
Duration: 460uS

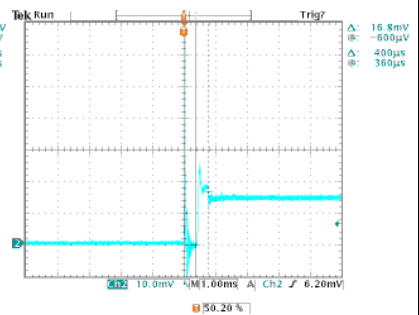

High Line, Full Load
Duration: 400uS

PXD20-48S15

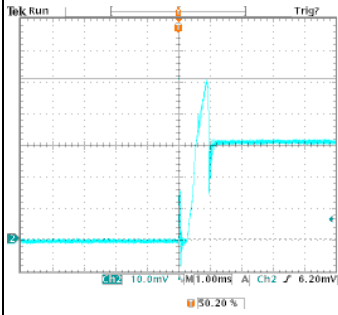

Low Line, Full Load

Inrush current= $(50.6/10) \times 200\text{mA}=1012\text{mA}$

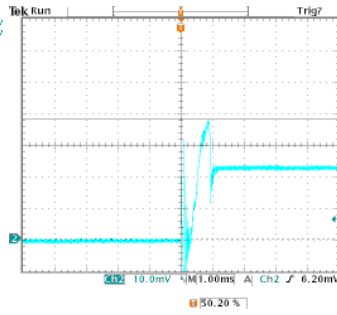

Normal Line, Full Load

Inrush current= $(37.8/10) \times 200\text{mA}=756\text{mA}$

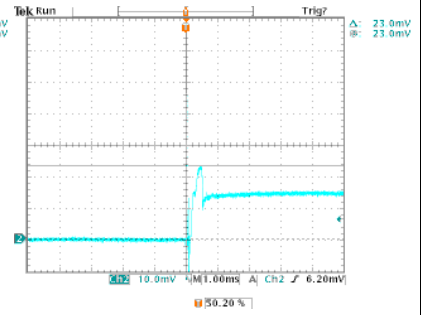

High Line, Full Load

Inrush current= $(23.0/10) \times 200\text{mA}=460\text{mA}$

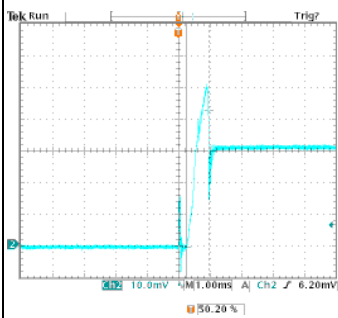

Low Line, Full Load

Duration: 700uS

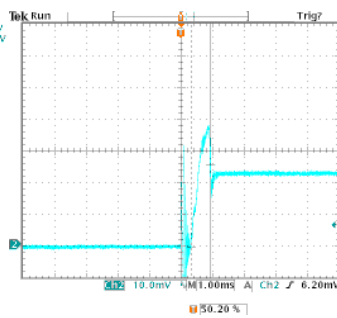

Normal Line, Full Load

Duration: 620uS

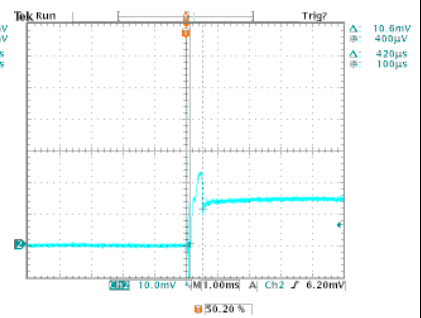

High Line, Full Load

Duration: 420uS

Input Ripple Current

PXD20-24S1P8

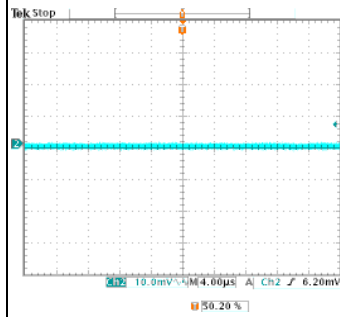

Low Line, Full Load
Ripple current= $(2.6/10) \times 20=5.2\text{mA}$

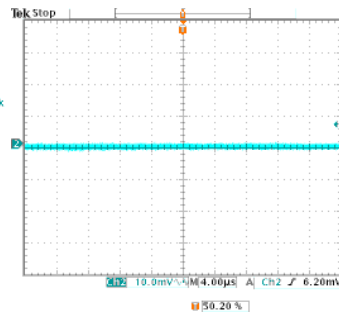

Normal Line, Full Load
Ripple current= $(2.8/10) \times 20=5.6\text{mA}$

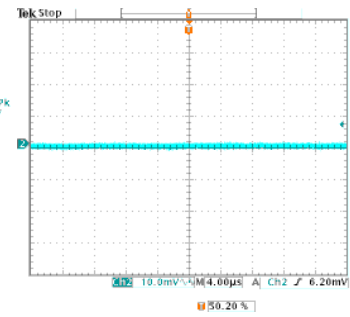

High Line, Full Load
Ripple current= $(3.0/10) \times 20=6.0\text{mA}$

PXD20-48S05

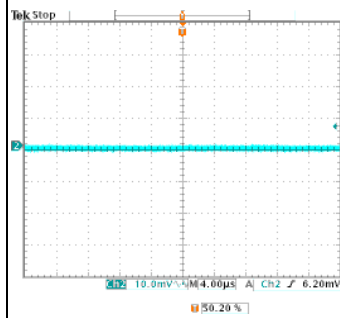

Low Line, Full Load
Ripple current= $(2.8/10) \times 20=5.6\text{mA}$

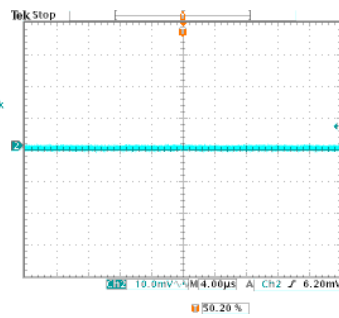

Normal Line, Full Load
Ripple current= $(2.60/10) \times 20=5.2\text{mA}$

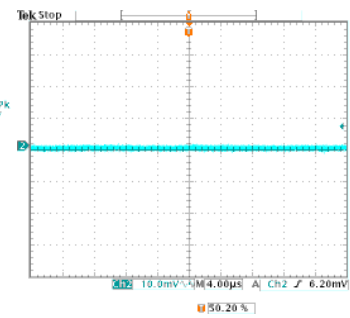

High Line, Full Load
Ripple current= $(3.2/10) \times 20=6.4\text{mA}$

PXD20-48S15

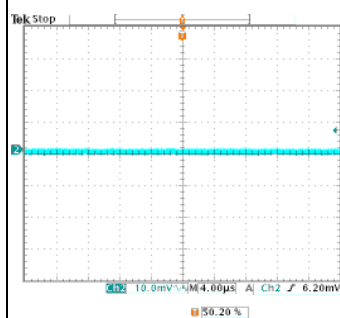

Low Line, Full Load
Ripple current= $(2.6/10) \times 20=5.2\text{mA}$

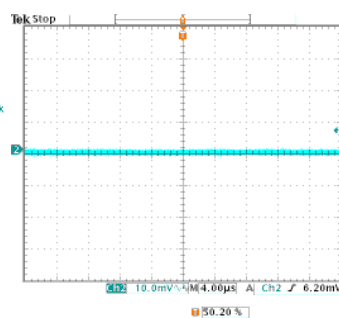

Normal Line, Full Load
Ripple current= $(2.4/10) \times 20=4.8\text{mA}$

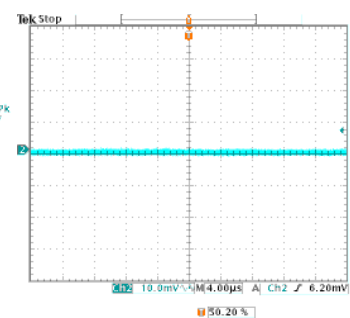

High Line, Full Load
Ripple current= $(2.8/10) \times 20=7.6\text{mA}$

Delay Time and Rise Time

PXD20-24S1P8

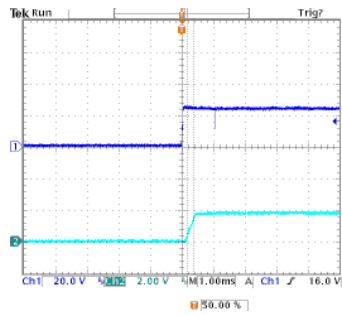

Normal Line, Full Load
Rise Time=235uS

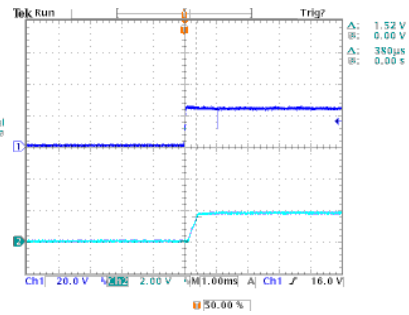

Normal Line, Full Load
Delay Time=380uS

PXD20-48S05

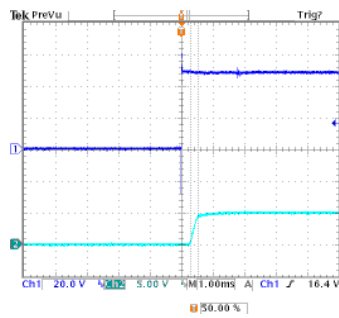

Normal Line, Full Load
Rise Time=234.9uS

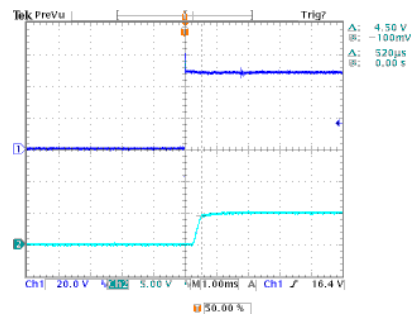

Normal Line, Full Load
Delay Time=520uS

PXD20-48S15

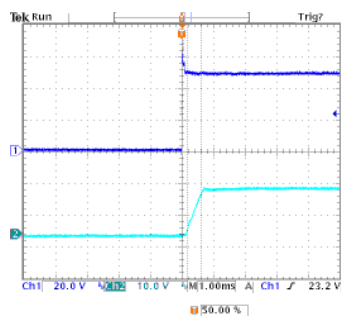

Normal Line, Full Load
Rise Time=448.3uS

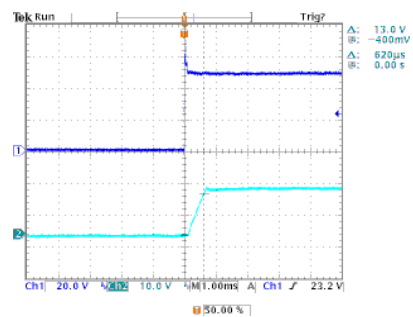

Normal Line, Full Load
Delay Time=620uS

Testing Configurations

Input reflected-ripple current Measurement Test:

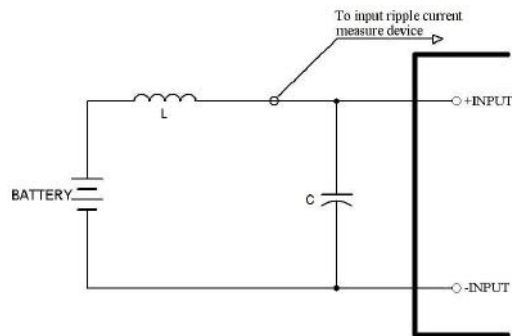

Component	Value	Voltage	Reference
L	12μH	----	----
C	100μF	100V	Aluminum Electrolytic Capacitor

Peak-to-peak output ripple & noise Measurement Test:

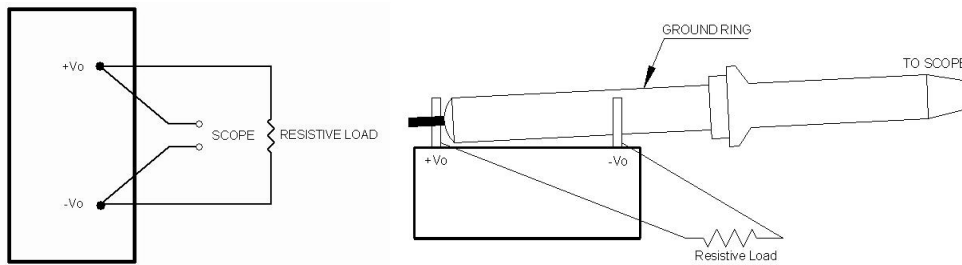

Output Voltage and Efficiency Measurement Test:

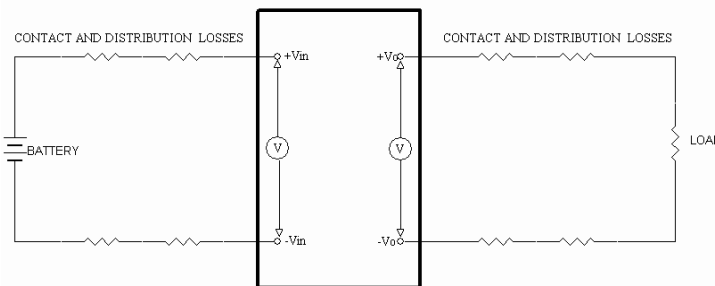

Note: All measurements are taken at the module terminals.

$$Efficiency = \left(\frac{V_o \times I_o}{V_{in} \times I_{in}} \right) \times 100\%$$

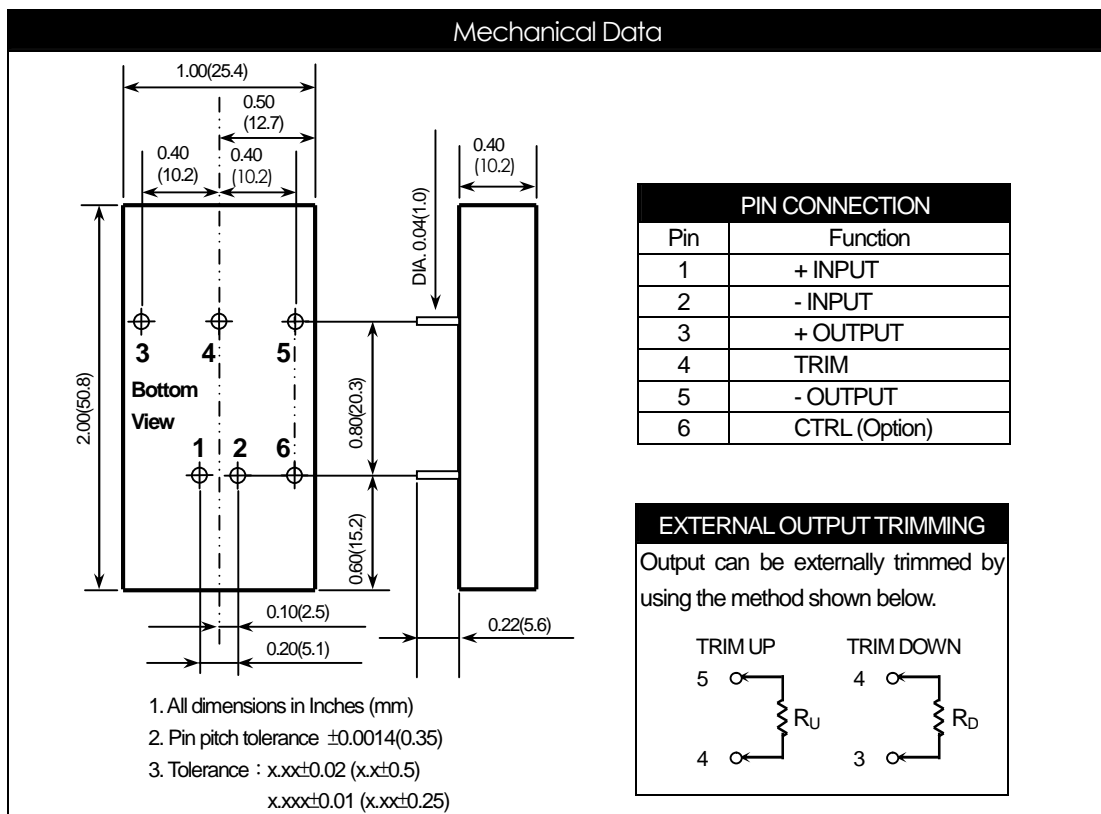
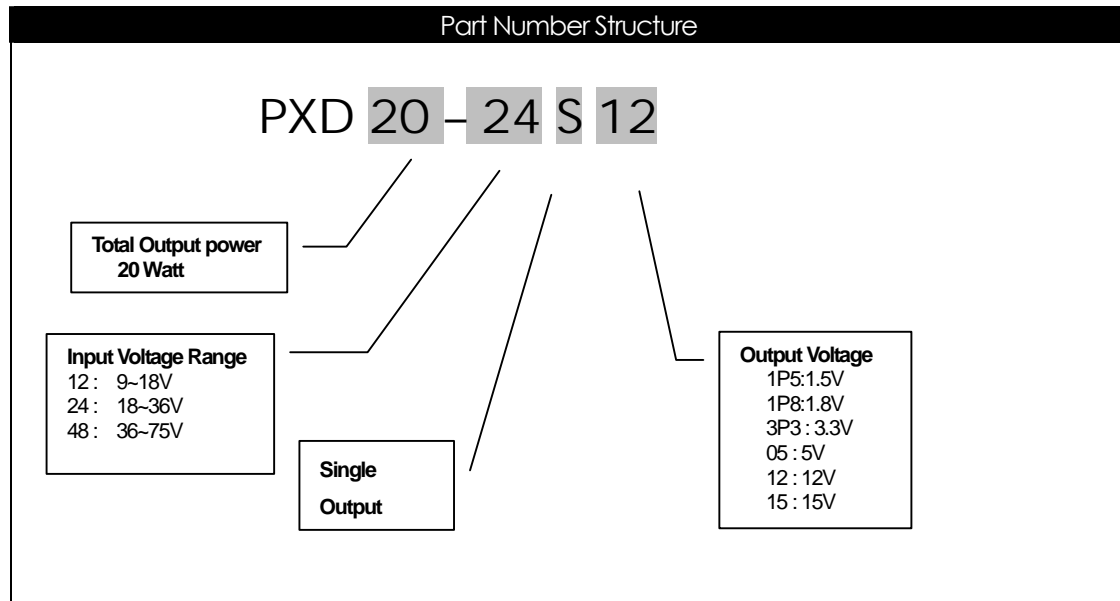

Safety and Installation Instruction

Isolation Consideration

The PXD20-xxSxx series features 1.6k Volt DC isolation from input to output, input to case, and output to case. The input to output resistance is greater than 10^9 ohms. Nevertheless, if the system using the power module needs safety agency approval, certain rules must be followed in the design of the system using the model. In particular, all of the creepage and clearance requirements of the end-use safety requirement must be observed. These documents include UL-60950-1, EN60950-1 and CSA 22.2-960, although specific applications may have other or additional requirements.

Fusing Consideration

Caution: This power module is not internally fused. An input line fuse must always be used. This encapsulated power module can be used in a wide variety of applications, ranging from simple stand-alone operation or an integrated part of a sophisticated power architecture. For maximum flexibility, internal fusing is not included; however, to achieve maximum safety and system protection, always use an input line fuse. The safety agencies require a slow-blow fuse with maximum rating of 3 A. Based on the information provided in this data sheet on inrush energy and maximum DC input current, the same type of fuse with lower rating can be used. Refer to the fuse manufacturer's data for further information.

MTBF and Reliability

The MTBF of PXD20-xxSxx series of DC/DC converters has been calculated using

1.MIL-HDBK-217F under the following conditions:

Nominal Input Voltage

$I_o = I_o, \text{max}$

$T_a = 25^\circ\text{C}$

The resulting figure for MTBF is 6.842×10^5 hours.

2.Bell-core TR-NWT-000332 Case I:

50% stress, Operating Temperature at 40°C (Ground fixed and controlled environment)

The resulting figure for MTBF is 1.791×10^6 hours.