



High-Precision Voltage Reference with Temperature Sensor

MAX6143

General Description

The MAX6143 is a low-noise, high-precision voltage reference. The device features a proprietary temperature-coefficient curvature-correction circuit and laser-trimmed thin-film resistors that result in a very low 3ppm/°C temperature coefficient and excellent $\pm 0.06\%$ initial accuracy. The MAX6143 provides a TEMP output where the output voltage is proportional to die temperature, making the device suitable for a wide variety of temperature-sensing applications. The device also provides a TRIM input, allowing fine trimming of the output voltage with a resistive-divider network. Low temperature drift and low noise make the MAX6143 ideal for use with high-resolution A/D or D/A converters.

The MAX6143 provides accurate preset +2.5V, +3.3V, +4.096V, +5.0V, and +10V reference voltages and accepts input voltages up to +40V. The device draws 340 μ A of supply current and sources 30mA or sinks 2mA of load current. The active-low shutdown feature (SHDN) reduces supply current to 0.01 μ A. The MAX6143 uses bandgap technology for low-noise performance and excellent accuracy. The MAX6143 does not require an output bypass capacitor for stability, and is stable with capacitive loads up to 100 μ F. Eliminating the output bypass capacitor saves valuable board area in space-critical applications.

The MAX6143 is available in an 8-pin SO package and operates over the automotive (-40°C to +125°C) temperature range.

Applications

A/D Converters	Voltage Regulators
D/A Converters	Threshold Detectors
Digital Voltmeters	

Features

- ◆ Wide ($V_{OUT} + 2V$) to +40V Supply Voltage Range
- ◆ Excellent Temperature Stability: 3ppm/°C (max)
- ◆ Tight Initial Accuracy: 0.05% (max)
- ◆ Low Noise: 3.8 μ Vp-p (typ at 2.5V Output)
- ◆ Sources up to 30mA Output Current
- ◆ Low Supply Current: 450 μ A (max at +25°C)
- ◆ Low 0.01 μ A Shutdown Current
- ◆ Linear Temperature Transducer Voltage Output
- ◆ +2.5V, +3.3V, +4.096V, +5.0V, or +10V Output Voltages
- ◆ Wide Operating Temperature Range: -40°C to +125°C
- ◆ No External Capacitors Required for Stability

Typical Operating Circuit

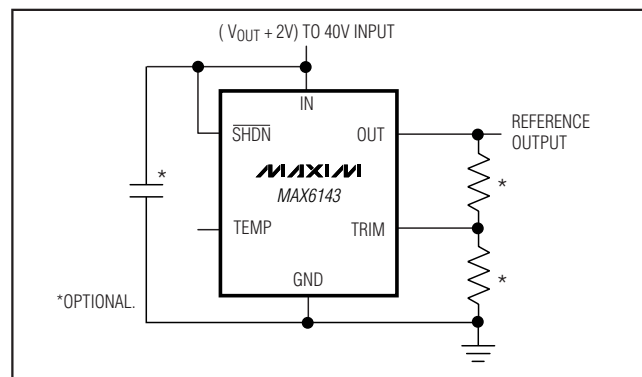

Pin Configuration appears at end of data sheet.

Ordering Information/Selector Guide

PART	TEMP RANGE	PIN-PACKAGE	OUTPUT VOLTAGE (V)	TEMPERATURE COEFFICIENT (ppm/°C) 40°C TO +125°C	INITIAL ACCURACY (%)
MAX6143AASA25	-40°C to +125°C	8 SO	2.500	3	0.06
MAX6143BASA25	-40°C to +125°C	8 SO	2.500	10	0.10
MAX6143AASA33	-40°C to +125°C	8 SO	3.300	3	0.06
MAX6143BASA33	-40°C to +125°C	8 SO	3.300	10	0.10
MAX6143AASA41	-40°C to +125°C	8 SO	4.096	3	0.06
MAX6143BASA41	-40°C to +125°C	8 SO	4.096	10	0.10
MAX6143AASA50	-40°C to +125°C	8 SO	5.000	3	0.06
MAX6143BASA50	-40°C to +125°C	8 SO	5.000	10	0.10
MAX6143AASA10	-40°C to +125°C	8 SO	10.000	3	0.05
MAX6143BASA10	-40°C to +125°C	8 SO	10.000	10	0.10



High-Precision Voltage Reference with Temperature Sensor

ABSOLUTE MAXIMUM RATINGS

IN to GND	-0.3V to +42V	Operating Temperature Range	-40°C to +125°C
OUT, SHDN, TRIM, TEMP to GND	-0.3V to (V _{IN} + 0.3V)	Junction Temperature	+150°C
Output Short Circuit to GND	5s	Storage Temperature Range	-65°C to +150°C
Continuous Power Dissipation (T _A = +70°C)		Lead Temperature (soldering, 10s)	+300°C
8-Pin SO (derate 5.9mW/°C above +70°C)	471mW		

Stresses beyond those listed under "Absolute Maximum Ratings" may cause permanent damage to the device. These are stress ratings only, and functional operation of the device at these or any other conditions beyond those indicated in the operational sections of the specifications is not implied. Exposure to absolute maximum rating conditions for extended periods may affect device reliability.

ELECTRICAL CHARACTERISTICS—MAX6143_25 (V_{OUT} = 2.5V)

(V_{IN} = V_{SHDN} = +5V, T_A = -40°C to +125°C, unless otherwise noted. Typical values are at T_A = +25°C.) (Note 1)

PARAMETER	SYMBOL	CONDITIONS	MIN	TYP	MAX	UNITS	
OUTPUT							
Output Voltage	V _{OUT}	No load, T _A = +25°C	MAX6143A_25 (0.06%)	2.4985	2.5	2.5015	V
			MAX6143B_25 (0.1%)	2.4975	2.5	2.5025	
Output Adjustment Range	ΔV _{TRIM}	R _{POT} = 10kΩ	±3	±6		%	
Output-Voltage Temperature Coefficient (Note 2)	TCV _{OUT}	T _A = -40°C to +125°C	MAX6143AASA	1.5	3	ppm/°C	
			MAX6143BASA	3	10		
Line Regulation (Note 3)	ΔV _{OUT} / ΔV _{IN}	4.5V ≤ V _{IN} ≤ 40V	T _A = +25°C	0.6	5	ppm/V	
			T _A = -40°C to +125°C	0.8	10		
Load Regulation (Note 3)	ΔV _{OUT} / ΔI _{OUT}	Sourcing: 0 ≤ I _{OUT} ≤ 10mA	T _A = +25°C	2	10	ppm/mA	
			T _A = -40°C to +125°C	2	15		
			Sinking: -0.6mA ≤ I _{OUT} ≤ 0	T _A = +25°C	50		500
				T _A = -40°C to +125°C	90		900
Output Short-Circuit Current	I _{SC}	OUT shorted to GND		60		mA	
		OUT shorted to IN		3			
Temperature Hysteresis (Note 4)	ΔV _{OUT} /cycle			120		ppm	
Long-Term Stability	ΔV _{OUT} /time	1000 hours at T _A = +25°C		50		ppm	
DYNAMIC							
Noise Voltage	e _{OUT}	f = 0.1Hz to 10Hz		3.8		μV _{P-P}	
		f = 10Hz to 1kHz		6.8		μV _{RMS}	
Turn-On Settling Time	t _{TR}	To V _{OUT} = 0.1% of final value, C _{OUT} = 50pF		150		μs	
INPUT							
Supply Voltage Range	V _{IN}	Guaranteed by line regulation test	4.5		40.0	V	
Quiescent Supply Current	I _{IN}	No load, normal operation	T _A = +25°C	300	450	μA	
			T _A = -40°C to +125°C		600		
Shutdown Supply Current	I _{SHDN}	No load, V _{SHDN} < 0.8V	T _A = -40°C to +125°C	0.01	5	μA	

High-Precision Voltage Reference with Temperature Sensor

MAX6143

ELECTRICAL CHARACTERISTICS—MAX6143_25 (V_{OUT} = 2.5V) (continued)

(V_{IN} = V_{SHDN} = +5V, T_A = -40°C to +125°C, unless otherwise noted. Typical values are at T_A = +25°C.) (Note 1)

PARAMETER	SYMBOL	CONDITIONS	MIN	TYP	MAX	UNITS
SHUTDOWN ($\overline{\text{SHDN}}$)						
Logic-High Input Voltage	V _{IH}		2.0			V
Logic-Low Input Voltage	V _{IL}				0.8	V
Logic-High Input Current	I _{IH}				20	μA
Logic-Low Input Current	I _{IL}				2	μA
TEMP OUTPUT						
TEMP Output Voltage	V _{TEMP}			570		mV
TEMP Temperature Coefficient	T _{CTEMP}			1.9		mV/°C

ELECTRICAL CHARACTERISTICS—MAX6143_33 (V_{OUT} = 3.3V)

(V_{IN} = V_{SHDN} = +10V, T_A = -40°C to +125°C, unless otherwise noted. Typical values are at T_A = +25°C.) (Note 1)

PARAMETER	SYMBOL	CONDITIONS	MIN	TYP	MAX	UNITS	
OUTPUT							
Output Voltage	V _{OUT}	No load, T _A = +25°C	MAX6143A_33 (0.06%)	3.2980	3.3	3.3020	V
			MAX6143B_33 (0.1%)	3.2967	3.3	3.3033	
Output Adjustment Range	ΔV _{TRIM}	R _{POT} = 10kΩ	±3	±6		%	
Output-Voltage Temperature Coefficient (Note 2)	T _{CVOUT}	T _A = -40°C to +125°C	MAX6143AASA	1.5	3	ppm/°C	
			MAX6143BASAA	3	10		
Line Regulation (Note 3)	ΔV _{OUT} / ΔV _{IN}	5.3V ≤ V _{IN} ≤ 40V	T _A = +25°C	0.6	5	ppm/V	
			T _A = -40°C to +125°C	0.8	10		
Load Regulation (Note 3)	ΔV _{OUT} / ΔI _{OUT}	Sourcing: 0 ≤ I _{OUT} ≤ 10mA	T _A = +25°C	2	10	ppm/ mA	
			T _A = -40°C to +125°C	2	15		
		Sinking: -0.6mA ≤ I _{OUT} ≤ 0	T _A = +25°C	50	500		
			T _A = -40°C to +125°C	90	900		
Output Short-Circuit Current	I _{SC}	OUT shorted to GND		60		mA	
		OUT shorted to IN		3			
Temperature Hysteresis (Note 4)	ΔV _{OUT} /cycle			120		ppm	
Long-Term Stability	ΔV _{OUT} /time	1000 hours at T _A = +25°C		50		ppm	
DYNAMIC							
Noise Voltage	e _{OUT}	f = 0.1Hz to 10Hz		5		μV _{P-P}	
		f = 10Hz to 1kHz		9.3		μV _{RMS}	
Turn-On Settling Time	t _R	To V _{OUT} = 0.1% of final value, C _{OUT} = 50pF		180		μs	

High-Precision Voltage Reference with Temperature Sensor

ELECTRICAL CHARACTERISTICS—MAX6143_33 (V_{OUT} = 3.3V) (continued)

(V_{IN} = V_{SHDN} = +10V, T_A = -40°C to +125°C, unless otherwise noted. Typical values are at T_A = +25°C.) (Note 1)

PARAMETER	SYMBOL	CONDITIONS		MIN	TYP	MAX	UNITS
INPUT							
Supply Voltage Range	V _{IN}	Guaranteed by line regulation test		5.3		40.0	V
Quiescent Supply Current	I _{IN}	No load, normal operation	T _A = +25°C		320	500	μA
			T _A = -40°C to +125°C			650	
Shutdown Supply Current	I _{SHDN}	No load, V _{SHDN} < 0.8V	T _A = -40°C to +125°C		0.01	5	μA
SHUTDOWN (SHDN)							
Logic-High Input Voltage	V _{IH}			2.0			V
Logic-Low Input Voltage	V _{IL}					0.8	V
Logic-High Input Current	I _{IH}					20	μA
Logic-Low Input Current	I _{IL}					2	μA
TEMP OUTPUT							
TEMP Output Voltage	V _{TEMP}				630		mV
TEMP Temperature Coefficient	T _{CTEMP}				2.1		mV/°C

ELECTRICAL CHARACTERISTICS—MAX6143_41 (V_{OUT} = 4.096V)

(V_{IN} = V_{SHDN} = +10V, T_A = -40°C to +125°C, unless otherwise noted. Typical values are at T_A = +25°C.) (Note 1)

PARAMETER	SYMBOL	CONDITIONS		MIN	TYP	MAX	UNITS
OUTPUT							
Output Voltage	V _{OUT}	No load, T _A = +25°C	MAX6143A_41 (0.06%)	4.0935	4.096	4.0985	V
			MAX6143B_41 (0.1%)	4.0919	4.096	4.1001	
Output Adjustment Range	ΔV _{TRIM}	R _{POT} = 10kΩ		±3	±6		%
Output-Voltage Temperature Coefficient (Note 2)	T _C V _{OUT}	T _A = -40°C to +125°C	MAX6143AASA		1.5	3	ppm/°C
			MAX6143BASA		3	10	
Line Regulation (Note 3)	ΔV _{OUT} /ΔV _{IN}	6.1V ≤ V _{IN} ≤ 40V	T _A = +25°C		0.6	5	ppm/V
			T _A = -40°C to +125°C		0.8	10	
Load Regulation (Note 3)	ΔV _{OUT} /ΔI _{OUT}	Sourcing: 0 ≤ I _{OUT} ≤ 10mA	T _A = +25°C		2	10	ppm/mA
			T _A = -40°C to +125°C		2	15	
		Sinking: -0.6mA ≤ I _{OUT} ≤ 0	T _A = +25°C		50	500	
			T _A = -40°C to +125°C		90	900	
Output Short-Circuit Current	I _{SC}	OUT shorted to GND			60		mA
		OUT shorted to IN			3		
Temperature Hysteresis (Note 4)	ΔV _{OUT} /cycle				120		ppm
Long-Term Stability	ΔV _{OUT} /time	1000 hours at T _A = +25°C			50		ppm

High-Precision Voltage Reference with Temperature Sensor

MAX6143

ELECTRICAL CHARACTERISTICS—MAX6143_41 (V_{OUT} = 4.096V) (continued)

(V_{IN} = V_{SHDN} = +10V, T_A = -40°C to +125°C, unless otherwise noted. Typical values are at T_A = +25°C.) (Note 1)

PARAMETER	SYMBOL	CONDITIONS		MIN	TYP	MAX	UNITS
DYNAMIC							
Noise Voltage	e _{OUT}	f = 0.1Hz to 10Hz		7			μV _{P-P}
		f = 10Hz to 1kHz		11.5			μV _{RMS}
Turn-On Settling Time	t _R	To V _{OUT} = 0.1% of final value, C _{OUT} = 50pF		200			μs
INPUT							
Supply Voltage Range	V _{IN}	Guaranteed by line regulation test		6.1		40.0	V
Quiescent Supply Current	I _{IN}	No load, normal operation	T _A = +25°C	320	500		μA
			T _A = -40°C to +125°C	650			
Shutdown Supply Current	I _{SHDN}	No load, V _{SHDN} < 0.8V	T _A = -40°C to +125°C	0.01	5		μA
SHUTDOWN (SHDN)							
Logic-High Input Voltage	V _{IH}			2.0			V
Logic-Low Input Voltage	V _{IL}					0.8	V
Logic-High Input Current	I _{IH}					20	μA
Logic-Low Input Current	I _{IL}					2	μA
TEMP OUTPUT							
TEMP Output Voltage	V _{TEMP}				630		mV
TEMP Temperature Coefficient	TC _{TEMP}	(0.06%)			2.1		mV/°C

ELECTRICAL CHARACTERISTICS—MAX6143_50 (V_{OUT} = 5.0V)

(V_{IN} = V_{SHDN} = +15V, T_A = -40°C to +125°C, unless otherwise noted. Typical values are at T_A = +25°C.) (Note 1)

PARAMETER	SYMBOL	CONDITIONS		MIN	TYP	MAX	UNITS
OUTPUT							
Output Voltage	V _{OUT}	No load, T _A = +25°C	MAX6143A_50 (0.06%)	4.9970	5.0	5.0030	V
			MAX6143B_50 (0.1%)	4.9950	5.0	5.0050	
Output Adjustment Range	ΔV _{TRIM}	R _{POT} = 10kΩ		±3	±6		%
Output-Voltage Temperature Coefficient (Note 2)	TC _{V_{OUT}}	T _A = -40°C to +125°C	MAX6143AASA		1.5	3	ppm/°C
			MAX6143BASA		3	10	
Line Regulation (Note 3)	ΔV _{OUT} / ΔV _{IN}	7V ≤ V _{IN} ≤ 40V	T _A = +25°C		0.6	5	ppm/V
			T _A = -40°C to +125°C		0.8	10	
Load Regulation (Note 3)	ΔV _{OUT} / ΔI _{OUT}	Sourcing: 0 ≤ I _{OUT} ≤ 10mA	T _A = +25°C		2	10	ppm/mA
			T _A = -40°C to +125°C		2	15	
		Sinking: -0.6mA ≤ I _{OUT} ≤ 0	T _A = +25°C		50	500	
			T _A = -40°C to +125°C		90	900	

High-Precision Voltage Reference with Temperature Sensor

ELECTRICAL CHARACTERISTICS—MAX6143_50 (V_{OUT} = 5.0V) (continued)

(V_{IN} = V_{SHDN} = +15V, T_A = -40°C to +125°C, unless otherwise noted. Typical values are at T_A = +25°C.) (Note 1)

PARAMETER	SYMBOL	CONDITIONS	MIN	TYP	MAX	UNITS
Output Short-Circuit Current	I _{SC}	OUT shorted to GND		60		mA
		OUT shorted to IN		3		
Temperature Hysteresis (Note 4)	ΔV _{OUT} /cycle			120		ppm
Long-Term Stability	ΔV _{OUT} /time	1000 hours at T _A = +25°C		50		ppm
DYNAMIC						
Noise Voltage	e _{OUT}	f = 0.1Hz to 10Hz		9		μV _{P-P}
		f = 10Hz to 1kHz		14.5		μV _{RMS}
Turn-On Settling Time	t _R	To V _{OUT} = 0.1% of final value, C _{OUT} = 50pF		230		μs
INPUT						
Supply Voltage Range	V _{IN}	Guaranteed by line regulation test	7		40	V
Quiescent Supply Current	I _{IN}	No load, normal operation	T _A = +25°C	320	550	μA
			T _A = -40°C to +125°C		700	
Shutdown Supply Current	I _{SHDN}	No load, V _{SHDN} < 0.8V		0.01	5	μA
SHUTDOWN (SHDN)						
Logic-High Input Voltage	V _{IH}		2.0			V
Logic-Low Input Voltage	V _{IL}				0.8	V
Logic-High Input Current	I _{IH}				20	μA
Logic-Low Input Current	I _{IL}				2	μA
TEMP OUTPUT						
TEMP Output Voltage	V _{TEMP}			630		mV
TEMP Temperature Coefficient	TC _{TEMP}			2.1		mV/°C

ELECTRICAL CHARACTERISTICS—MAX6143_10 (V_{OUT} = 10V)

(V_{IN} = V_{SHDN} = +15V, T_A = -40°C to +125°C, unless otherwise noted. Typical values are at T_A = +25°C.) (Note 1)

PARAMETER	SYMBOL	CONDITIONS	MIN	TYP	MAX	UNITS	
OUTPUT							
Output Voltage	V _{OUT}	No load, T _A = +25°C	MAX6143A_10 (0.05%)	9.995	10.0	10.005	V
			MAX6143B_10 (0.1%)	9.990	10.0	10.010	
Output Adjustment Range	ΔV _{TRIM}	R _{POT} = 10kΩ	±3	±6		%	
Output-Voltage Temperature Coefficient (Note 2)	TC _{VOUT}	T _A = -40°C to +125°C	MAX6143AASA	1.5	3	ppm/°C	
			MAX6143BASA	3	10		
Line Regulation (Note 3)	ΔV _{OUT} /ΔV _{IN}	12V ≤ V _{IN} ≤ 40V	T _A = +25°C	0.6	5	ppm/V	
			T _A = -40°C to +125°C	0.8	10		

High-Precision Voltage Reference with Temperature Sensor

MAX6143

ELECTRICAL CHARACTERISTICS—MAX6143_10 (V_{OUT} = 10V) (continued)

(V_{IN} = V_{SHDN} = +15V, T_A = -40°C to +125°C, unless otherwise noted. Typical values are at T_A = +25°C.) (Note 1)

PARAMETER	SYMBOL	CONDITIONS	MIN	TYP	MAX	UNITS
Load Regulation (Note 3)	$\Delta V_{OUT}/\Delta I_{OUT}$	Sourcing: 0 ≤ I _{OUT} ≤ 10mA	T _A = +25°C	2	10	ppm/mA
			T _A = -40°C to +125°C	2	15	
		Sinking: -0.6mA ≤ I _{OUT} ≤ 0	T _A = +25°C	50	500	
			T _A = -40°C to +125°C	90	900	
Output Short-Circuit Current	I _{SC}	OUT shorted to GND		60		mA
		OUT shorted to IN		3		
Temperature Hysteresis (Note 4)	$\Delta V_{OUT}/\text{cycle}$			120		ppm
Long-Term Stability	$\Delta V_{OUT}/\text{time}$	1000 hours at T _A = +25°C		50		ppm
DYNAMIC						
Noise Voltage	e _{OUT}	f = 0.1Hz to 10Hz		18		μV _{P-P}
		f = 10Hz to 1kHz		29		μV _{RMS}
Turn-On Settling Time	t _R	To V _{OUT} = 0.1% of final value, C _{OUT} = 50pF		400		μs
INPUT						
Supply Voltage Range	V _{IN}	Guaranteed by line regulation test	12		40	V
Quiescent Supply Current	I _{IN}	No load, normal operation	T _A = +25°C	340	550	μA
			T _A = -40°C to +125°C			
Shutdown Supply Current	I _{SHDN}	No load, V _{SHDN} < 0.8V		0.01	5	μA
SHUTDOWN (SHDN)						
Logic-High Input Voltage	V _{IH}		2.0			V
Logic-Low Input Voltage	V _{IL}				0.8	V
Logic-High Input Current	I _{IH}				20	μA
Logic-Low Input Current	I _{IL}				2	μA
TEMP OUTPUT						
TEMP Output Voltage	V _{TEMP}			630		mV
TEMP Temperature Coefficient	T _{CTEMP}			2.1		mV/°C

Note 1: All devices are 100% production tested at T_A = +25°C and guaranteed by design over T_A = T_{MIN} to T_{MAX}, as specified.

Note 2: Temperature coefficient is defined as ΔV_{OUT} divided by the temperature range.

Note 3: Line and load regulation specifications do not include the effects of self-heating.

Note 4: Thermal hysteresis is defined as the change in +25°C output voltage before and after cycling the device from T_{MAX} to T_{MIN}.

High-Precision Voltage Reference with Temperature Sensor

Typical Operating Characteristics

($V_{IN} = +5V$ for $V_{OUT} = +2.5V$, $V_{IN} = +15V$ for $V_{OUT} = +10V$, $I_{OUT} = 0$, $T_A = +25^\circ C$, unless otherwise noted.)

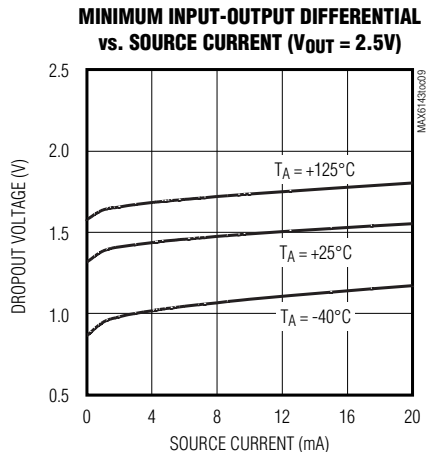
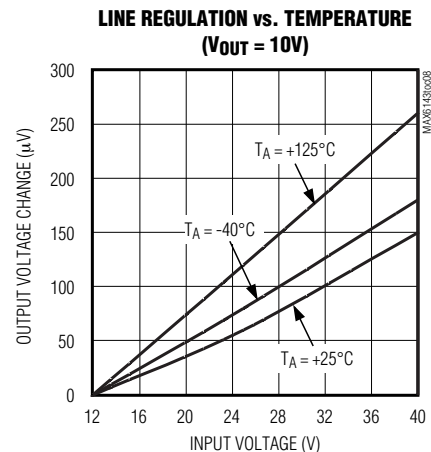
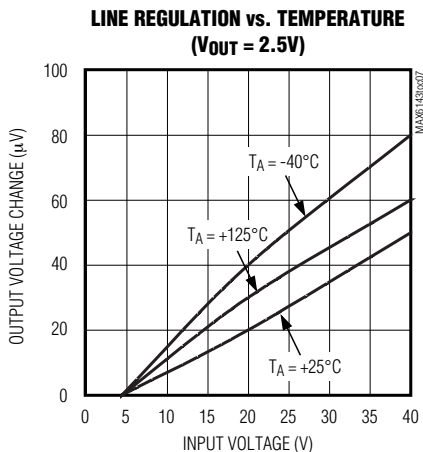
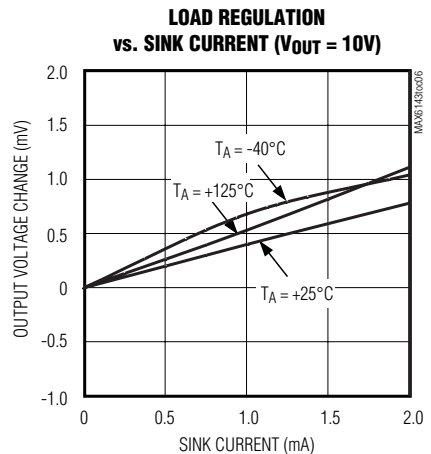
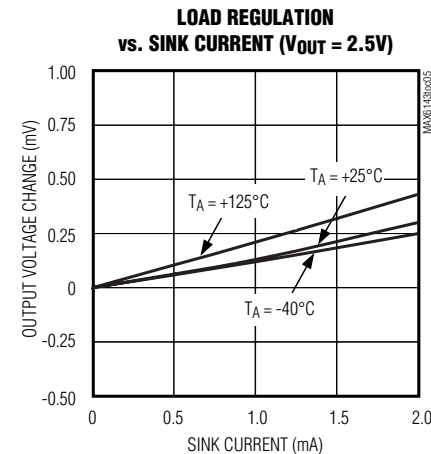
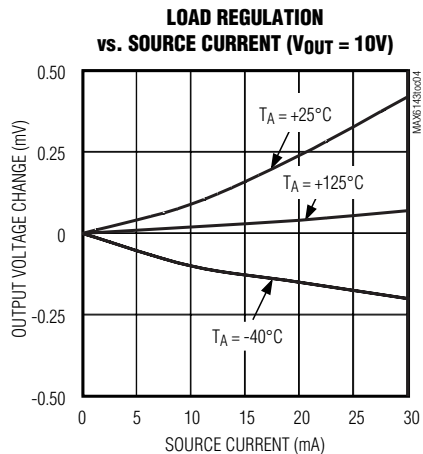
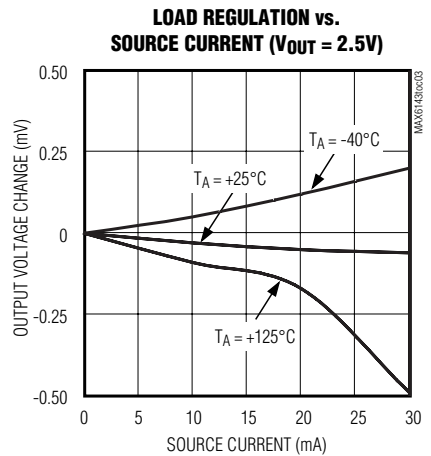
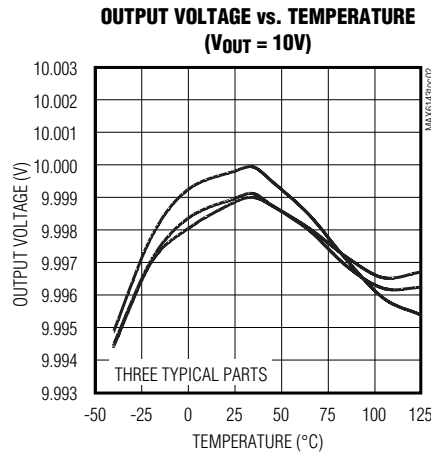
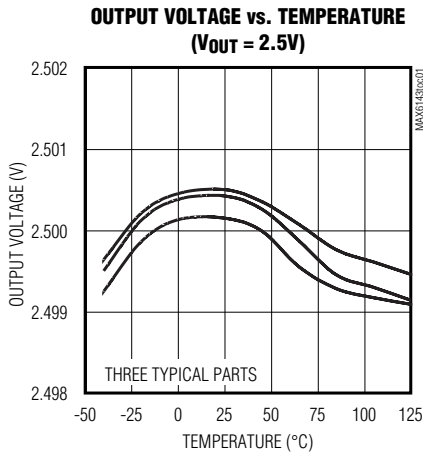

High-Precision Voltage Reference with Temperature Sensor

MAX6143

Typical Operating Characteristics (continued)

($V_{IN} = +5V$ for $V_{OUT} = +2.5V$, $V_{IN} = +15V$ for $V_{OUT} = +10V$, $I_{OUT} = 0$, $T_A = +25^\circ C$, unless otherwise noted.)

MINIMUM INPUT-OUTPUT DIFFERENTIAL vs. SOURCE CURRENT ($V_{OUT} = 10V$)

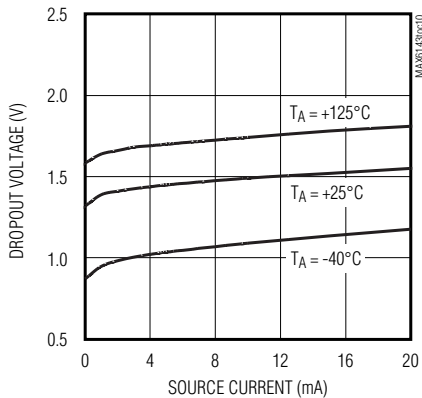

POWER-SUPPLY REJECTION RATIO vs. FREQUENCY ($V_{OUT} = 2.5V$)

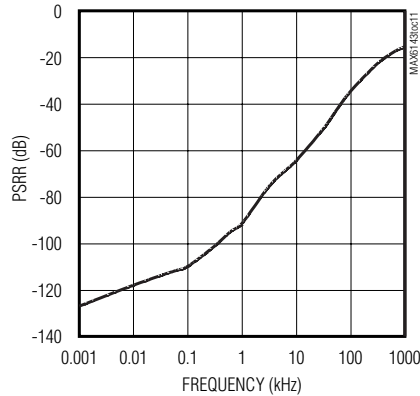

POWER-SUPPLY REJECTION RATIO vs. FREQUENCY ($V_{OUT} = 10V$)

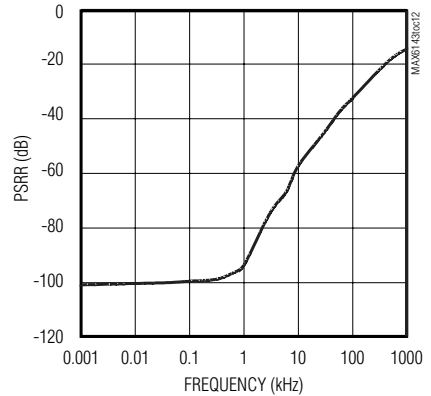

OUTPUT IMPEDANCE vs. FREQUENCY ($V_{OUT} = 2.5V$)

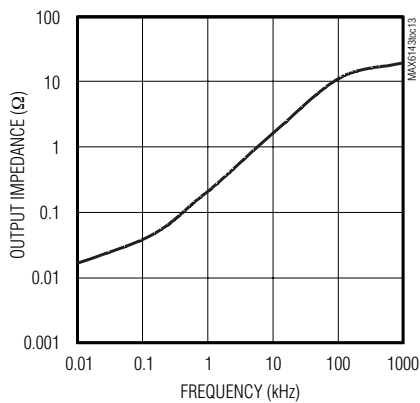

SUPPLY CURRENT vs. INPUT VOLTAGE ($V_{OUT} = 2.5V$)

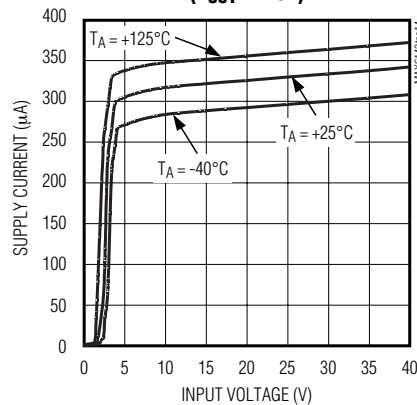

SUPPLY CURRENT vs. INPUT VOLTAGE ($V_{OUT} = 10V$)

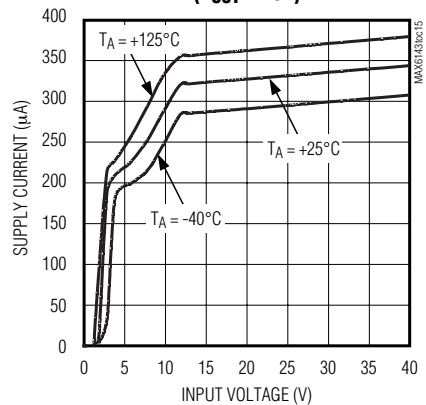

SUPPLY CURRENT vs. TEMPERATURE ($V_{OUT} = 2.5V$)

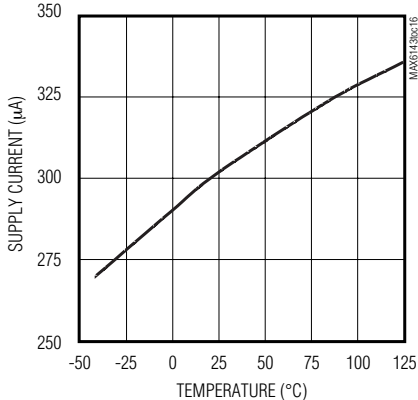

SUPPLY CURRENT vs. TEMPERATURE ($V_{OUT} = 10V$)

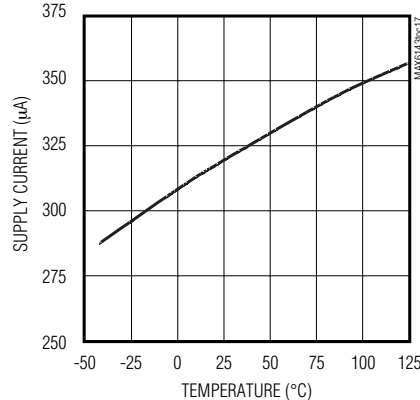

SHUTDOWN SUPPLY CURRENT vs. TEMPERATURE ($V_{OUT} = 2.5V$)

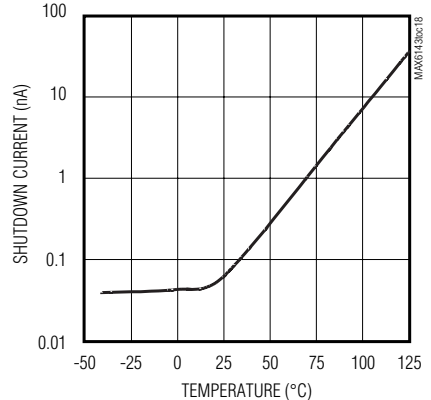

High-Precision Voltage Reference with Temperature Sensor

Typical Operating Characteristics (continued)

($V_{IN} = +5V$ for $V_{OUT} = +2.5V$, $V_{IN} = +15V$ for $V_{OUT} = +10V$, $I_{OUT} = 0$, $T_A = +25^\circ C$, unless otherwise noted.)

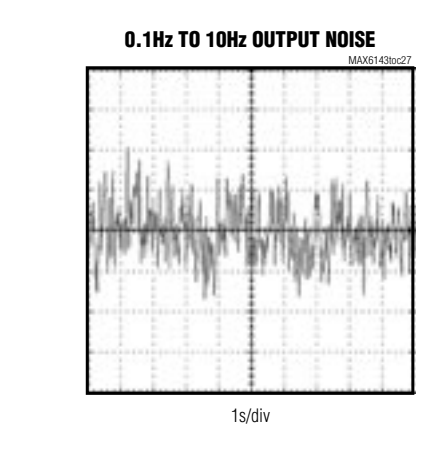
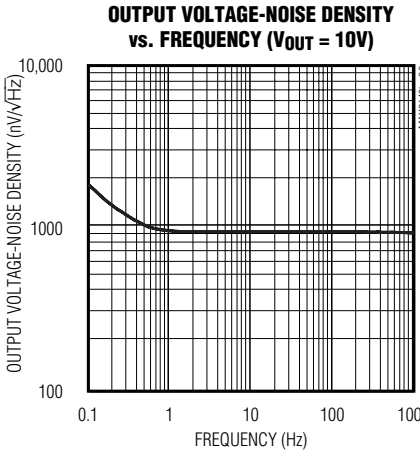
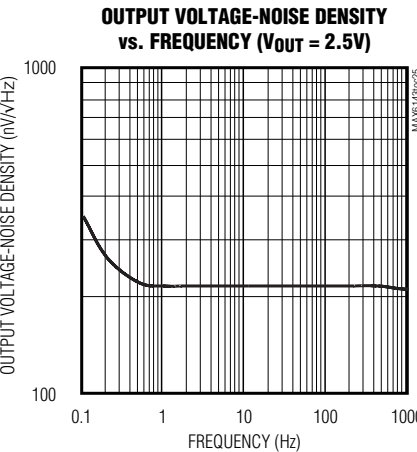
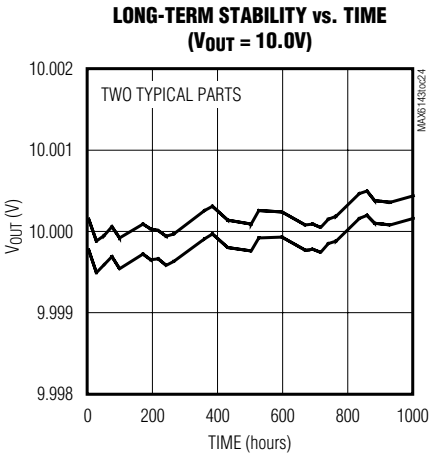
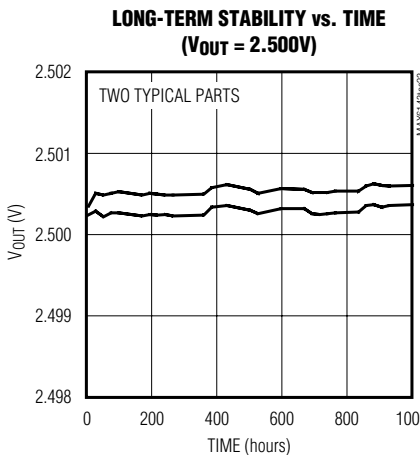
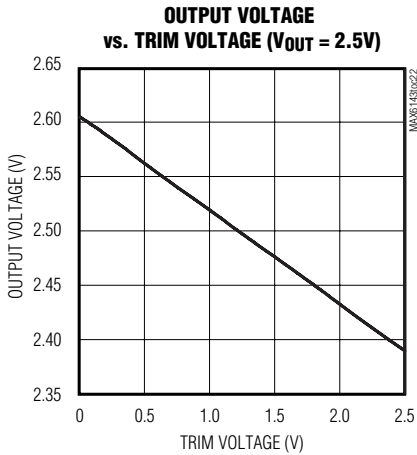
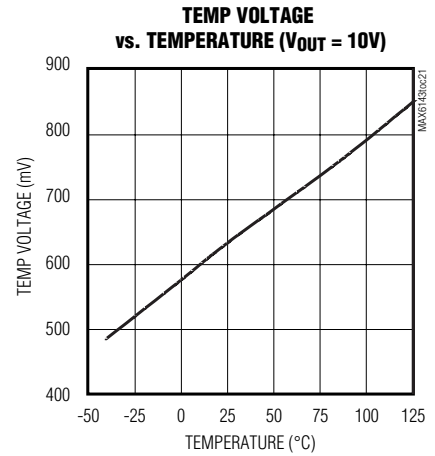
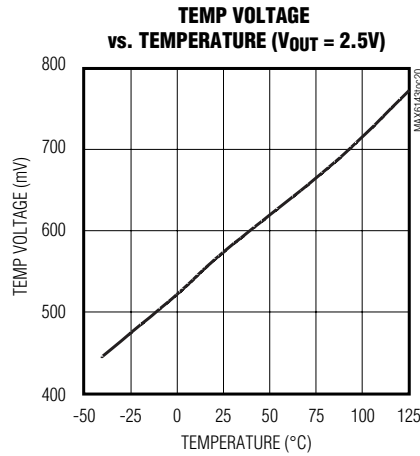
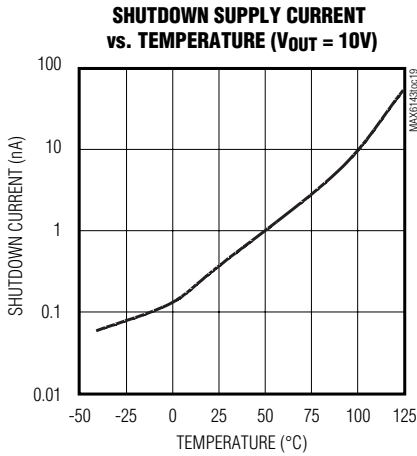

High-Precision Voltage Reference with Temperature Sensor

MAX6143

Typical Operating Characteristics (continued)

($V_{IN} = +5V$ for $V_{OUT} = +2.5V$, $V_{IN} = +15V$ for $V_{OUT} = +10V$, $I_{OUT} = 0$, $T_A = +25^\circ C$, unless otherwise noted.)

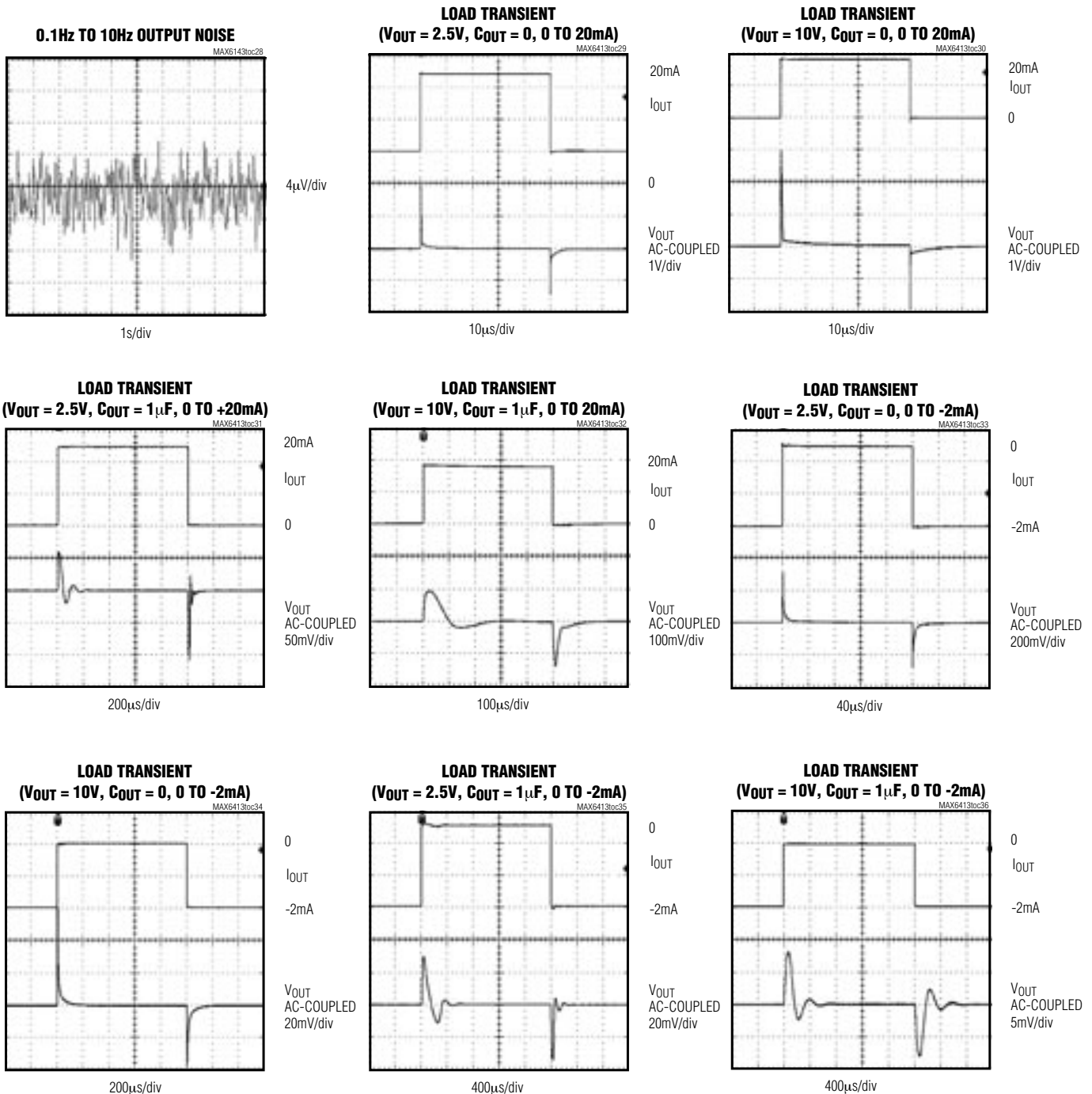

High-Precision Voltage Reference with Temperature Sensor

Typical Operating Characteristics (continued)

($V_{IN} = +5V$ for $V_{OUT} = +2.5V$, $V_{IN} = +15V$ for $V_{OUT} = +10V$, $I_{OUT} = 0$, $T_A = +25^\circ C$, unless otherwise noted.)

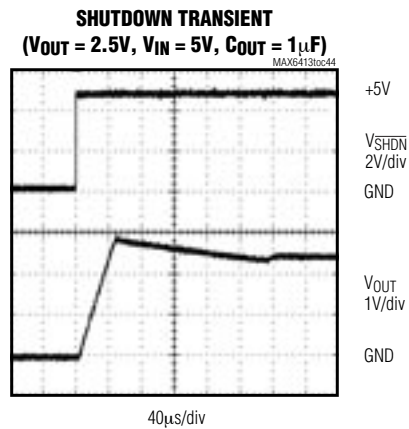
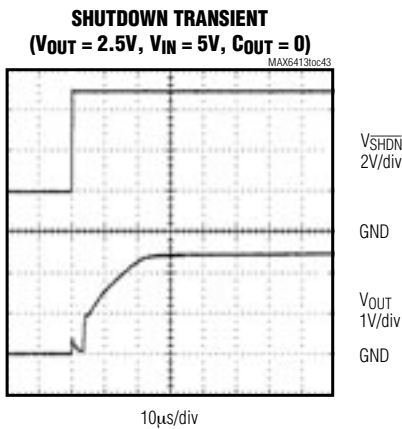
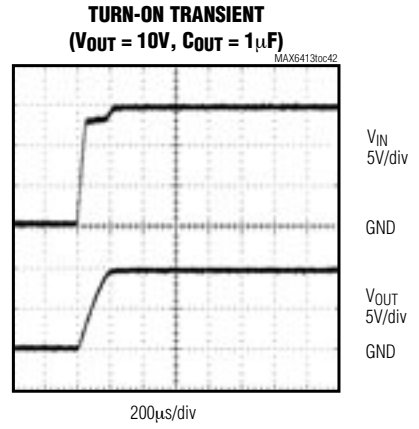
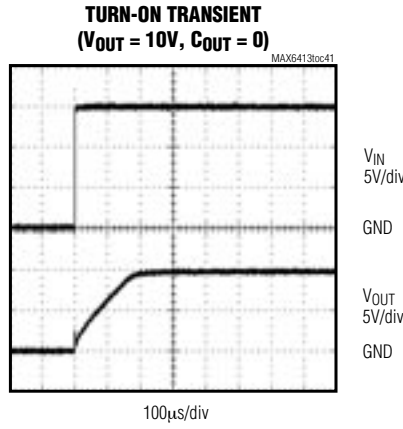
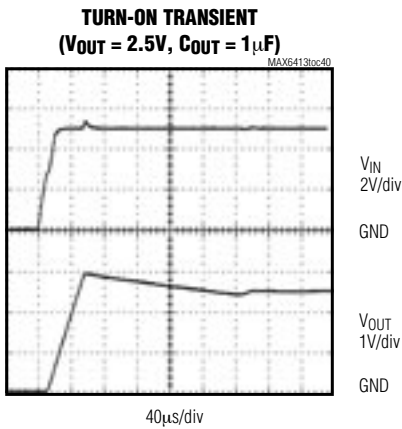
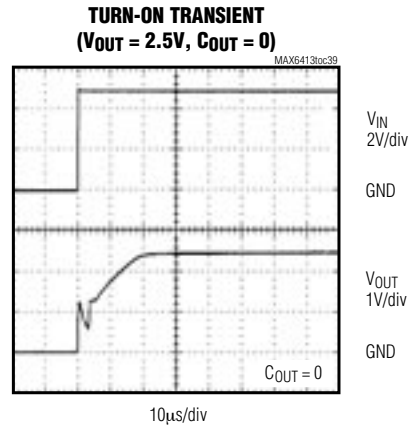
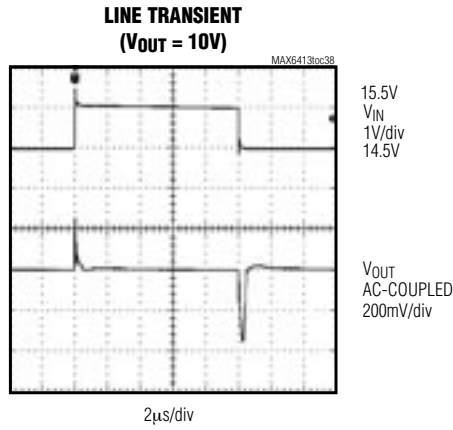
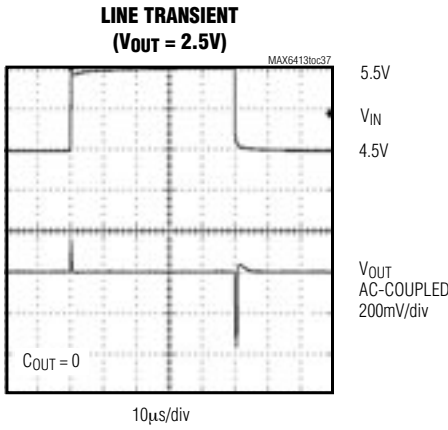

High-Precision Voltage Reference with Temperature Sensor

MAX6143

Typical Operating Characteristics (continued)

($V_{IN} = +5V$ for $V_{OUT} = +2.5V$, $V_{IN} = +15V$ for $V_{OUT} = +10V$, $I_{OUT} = 0$, $T_A = +25^\circ C$, unless otherwise noted.)

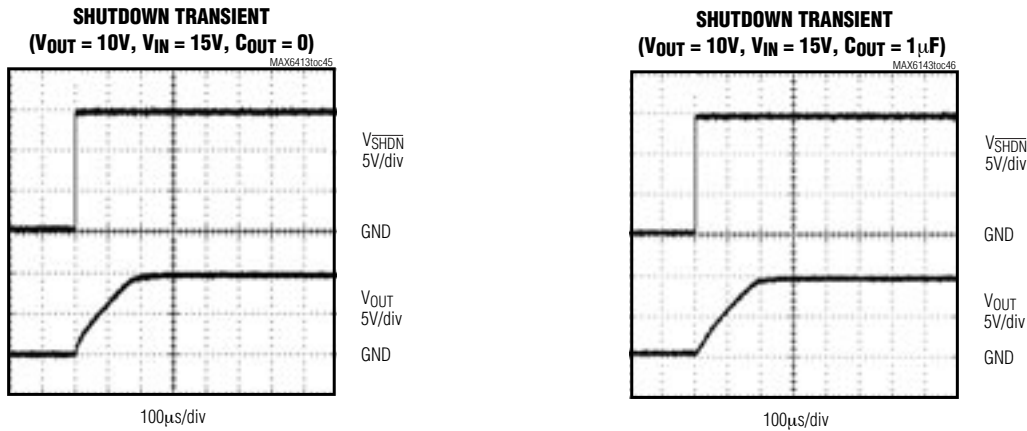

Pin Description

PIN	NAME	FUNCTION
1, 8	I.C.	Internally Connected. Do not connect externally.
2	IN	Positive Power-Supply Input
3	TEMP	Temperature Proportional Output Voltage. TEMP generates an output voltage proportional to the die temperature.
4	GND	Ground
5	TRIM	Output Voltage Trim. Connect TRIM to the center of a voltage-divider between OUT and GND for trimming. Leave unconnected to use the preset output voltage.
6	OUT	Output Voltage
7	SHDN	Active-Low Shutdown. Connect SHDN to IN for normal operation.

Detailed Description

The MAX6143 precision voltage reference provides accurate preset +2.5V, +3.3V, +4.096V, +5.0V, and +10V reference voltages from up to +40V input voltages. These devices feature a proprietary temperature-coefficient curvature-correction circuit and laser-trimmed thin-film resistors that result in a very low 3ppm/°C temperature coefficient and excellent 0.05% initial accuracy. The MAX6143 draws 340µA of supply current and sources 30mA or sinks 2mA of load current.

Trimming the Output Voltage

Trim the factory-preset output voltage on the MAX6143 by placing a resistive-divider network between OUT, TRIM, and GND. Use the following formula to calculate the change in output voltage from its preset value:

$$\Delta V_{OUT} = 2 \times (V_{TRIM} - V_{TRIM(open)}) \times k$$

where:

$$V_{TRIM} = 0 \text{ to } V_{OUT}$$

$$V_{TRIM(open)} = V_{OUT(nominal)} / 2 \text{ (typ)}$$

$$k = \pm 6\% \text{ typ}$$

For example, use a 50kΩ potentiometer (such as the MAX5436) between OUT, TRIM, and GND with the potentiometer wiper connected to TRIM (see Figure 2). As the TRIM voltage changes from V_{OUT} to GND, the output voltage changes accordingly. Set R2 to 1MΩ or less. Currents through resistors R1 and R2 add to the quiescent supply current.

High-Precision Voltage Reference with Temperature Sensor

Temp Output

The MAX6143 provides a temperature output proportional to die temperature. TEMP can be calculated from the following formula:

$$\text{TEMP (V)} = T_J (\text{°K}) \times n$$

where T_J = the die temperature,

n = the temperature multiplier,

$$n = \frac{V_{\text{TEMP}}(\text{at } T_J = T_0)}{T_0} \approx 1.9\text{mV/°K}$$

T_A = the ambient temperature.

Self-heating affects the die temperature and conversely, the TEMP output. The TEMP equation assumes the output is not loaded. If device power dissipation is negligible, then $T_J \approx T_A$.

Applications Information

Bypassing/Output Capacitance

For the best line-transient performance, decouple the input with a 0.1 μ F ceramic capacitor as shown in the *Typical Operating Circuit*. Place the capacitor as close to IN as possible. When transient performance is less important, no capacitor is necessary.

The MAX6143 does not require an output capacitor for stability and is stable with capacitive loads up to 100 μ F. In applications where the load or the supply can experience step changes, a larger output capacitor reduces the amount of overshoot (undershoot) and improves the circuit's transient response. Place output capacitors as close to the device as possible for best performance.

Supply Current

The MAX6143 consumes 340 μ A of quiescent supply current. This improved efficiency reduces power dissipation and extends battery life.

Shutdown

The active-low shutdown feature reduces supply current to 0.01 μ A (typ), further extending battery life. Connect $\overline{\text{SHDN}}$ to GND to activate shutdown. Connect $\overline{\text{SHDN}}$ to IN for normal operation.

Thermal Hysteresis

Thermal hysteresis is the change in the output voltage at $T_A = +25^\circ\text{C}$ before and after the device is cycled over its entire operating temperature range. Hysteresis is caused by differential package stress appearing across the bandgap core transistors. The typical thermal hysteresis value is 120ppm.

Turn-On Time

The MAX6143 typically turns on and settles to within 0.1% of the preset output voltage in 150 μ s (2.5V output). The turn-on time can increase up to 150 μ s with the device operating at a 1 μ F load.

Short-Circuited Outputs

The MAX6143 features a short-circuit-protected output. Internal circuitry limits the output current to 60mA when short circuiting the output to ground. The output current is limited to 3mA when short circuiting the output to the input.

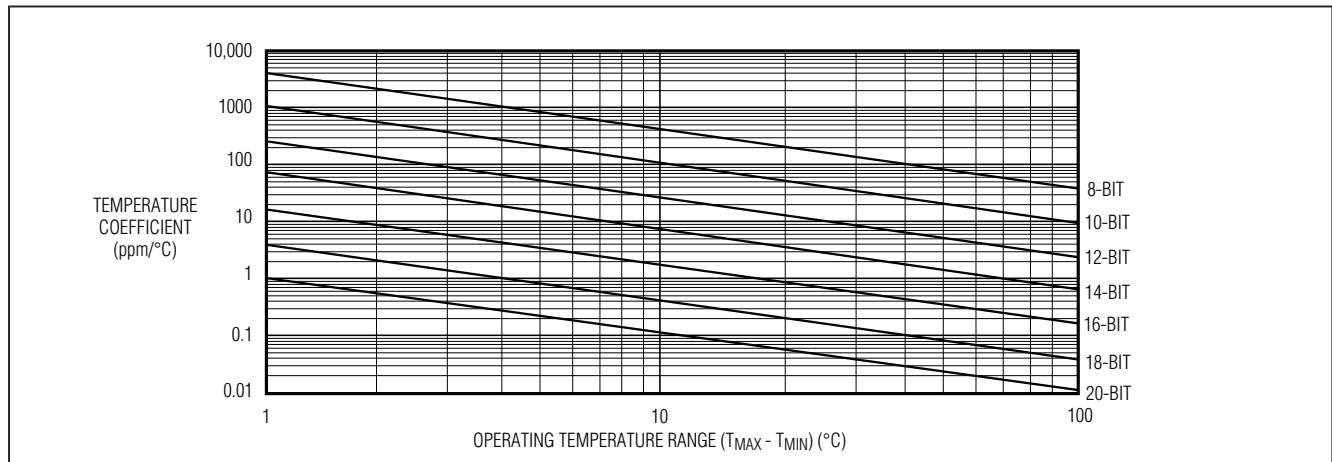

Figure 1. Temperature Coefficient vs. Operating Temperature Range for a 1 LSB Maximum Error

High-Precision Voltage Reference with Temperature Sensor

Temperature Coefficient vs. Operating Temperature Range for a 1 LSB Maximum Error

In a data converter application, the reference voltage of the converter must stay within a certain limit to keep the error in the data converter smaller than the resolution limit through the operating temperature range. Figure 1 shows the maximum allowable reference-voltage temperature coefficient to keep the conversion error to less than 1 LSB, as a function of the operating temperature range ($T_{MAX} - T_{MIN}$) with the converter resolution as a parameter. The graph assumes the reference-voltage temperature coefficient as the only parameter affecting accuracy.

In reality, the absolute static accuracy of a data converter is dependent on the combination of many parameters such as integral nonlinearity, differential nonlinearity, offset error, gain error, as well as voltage-reference changes.

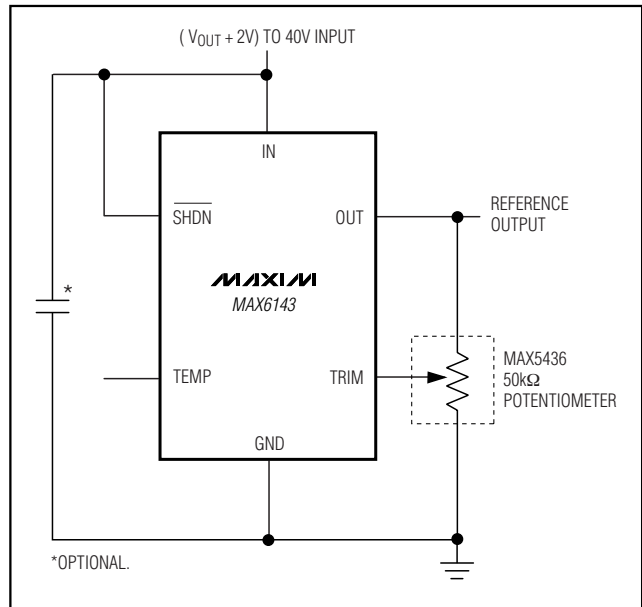
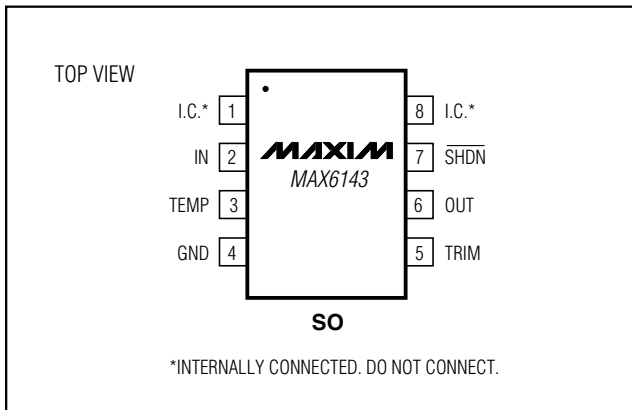

Figure 2. Applications Circuit Using the MAX5436 Potntiometer

MAX6143

Pin Configuration



Chip Information

TRANSISTOR COUNT: 429
PROCESS: BiCMOS

High-Precision Voltage Reference with Temperature Sensor

Package Information

(The package drawing(s) in this data sheet may not reflect the most current specifications. For the latest package outline information go to www.maxim-ic.com/packages.)

SOICN EPSS

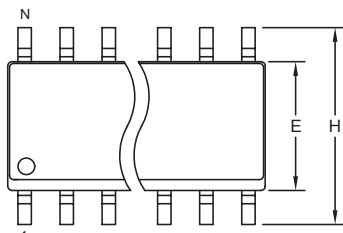

TOP VIEW

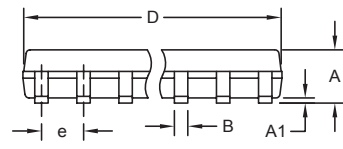

FRONT VIEW

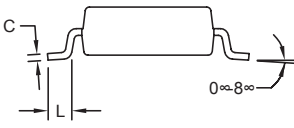

SIDE VIEW

NOTES:

1. D&E DO NOT INCLUDE MOLD FLASH.
2. MOLD FLASH OR PROTRUSIONS NOT TO EXCEED 0.15mm (.006").
3. LEADS TO BE COPLANAR WITHIN 0.10mm (.004").
4. CONTROLLING DIMENSION: MILLIMETERS.
5. MEETS JEDEC MS012.
6. N = NUMBER OF PINS.

DIM	INCHES		MILLIMETERS	
	MIN	MAX	MIN	MAX
A	0.053	0.069	1.35	1.75
A1	0.004	0.010	0.10	0.25
B	0.014	0.019	0.35	0.49
C	0.007	0.010	0.19	0.25
e	0.050 BSC		1.27 BSC	
E	0.150	0.157	3.80	4.00
H	0.228	0.244	5.80	6.20
L	0.016	0.050	0.40	1.27

VARIATIONS:

DIM	INCHES		MILLIMETERS		N	MS012
	MIN	MAX	MIN	MAX		
D	0.189	0.197	4.80	5.00	8	AA
D	0.337	0.344	8.55	8.75	14	AB
D	0.386	0.394	9.80	10.00	16	AC

DALLAS SEMICONDUCTOR **MAXIM**

PROPRIETARY INFORMATION

TITLE: PACKAGE OUTLINE, .150" SOIC

APPROVAL	DOCUMENT CONTROL NO.	REV.	
	21-0041	B	1/1

Maxim cannot assume responsibility for use of any circuitry other than circuitry entirely embodied in a Maxim product. No circuit patent licenses are implied. Maxim reserves the right to change the circuitry and specifications without notice at any time.

16 **Maxim Integrated Products, 120 San Gabriel Drive, Sunnyvale, CA 94086 408-737-7600**