

SUMMARY



Image is for illustrative purpose only

Wires

Low voltage 2

Series	2B
Termination type	Male solder
IP rating	50
AWG wire size	22.00 - 14.00
Cable Ø	0.00 - 0.00 mm
Status	active
Matching parts	EGG.2B.302.CLL

Download

[Request a quote](#)

[Catalog](#)

TECHNICAL DETAILS

Mechanics

Shell Style/Model	FW*: Fixed plug, nut fixing
Keying	1 key (alpha=0, plug: male contacts, receptacle: female contacts)
Housing Material	Brass (chrome plated [SAE AMS 2460]) shell and collet nut, nickel plated [SAE AMS QQ N 290] brass latch sleeve and mid pieces
Weight	18.55 g

Performance

Configuration	2B.302 : 2 Low Voltage
Insulator	L: PEEK (UL 94 / V-0/1.5)
Rated Current	25 Amps

Specifications

Contact Type:	Solder
Contact Dia.:	2 mm (0.079in)
Bucket Dia.:	1.8 mm (0.071in)
Max. Solid Conductor:	1.5 mm ² (AWG 14)
Max. Stranded Conductor:	1.5 mm ² (AWG 16)
R (max):	3.3 mOhm
Vtest (contact-shell):	1750 V (AC), 2500 V (DC)
Vtest (contact-contact):	2100 V (AC), 2970 V (DC)

LEMO products and services are provided "as is". LEMO makes no warranties or representations with regard to LEMO product & services or use of them, express, implied or statutory, including for accuracy, completeness, or security. The user is fully responsible for his products and applications using LEMO components.

Others

Endurance (Shell): 5000
 Temp (min / max): -55° C / +250° C
 Humidity (max): <=95% [at 60 deg C /140 F]
 Vibration: 15 g [10 Hz - 2000 Hz]
 Shock Resistance: 100 g [6 ms]
 Climatical Category: 50/175/21
 Shielding (min): 75 dB (10 MHz)
 Shielding (min): 40 dB (1 GHz)
 Salt Spray Corrosion: >1000 hr

DRAWINGS

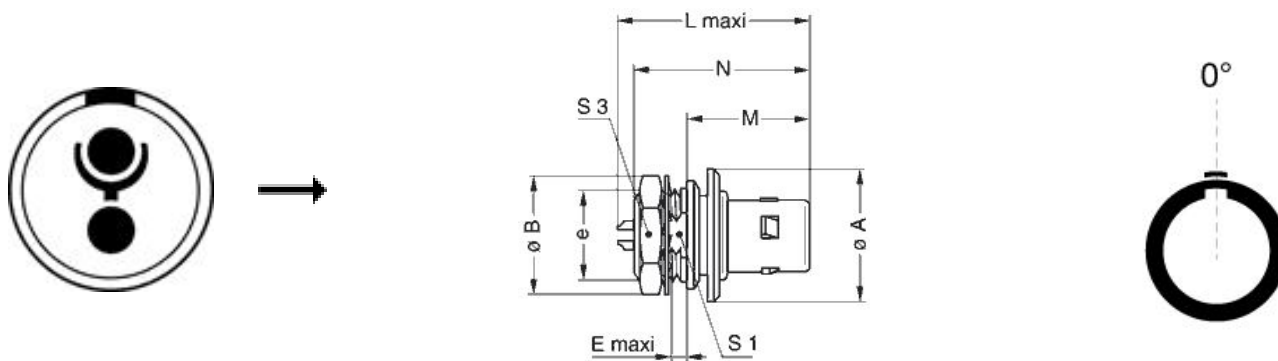

Dimensions

































	A	B	E	L	M	N	S1	S3	e
mm.	19.5	19.5	4.1	28.6	18	27.3	13.5	17	M15x1.0
in.	0,77	0,77	0,16	1,13	0,71	1,07	0,53	0,67	

RECOMMENDED BY LEMO







Tools

LEMO products and services are provided "as is". LEMO makes no warranties or representations with regard to LEMO product & services or use of them, express, implied or statutory, including for accuracy, completeness, or security. The user is fully responsible for his products and applications using LEMO components.

Cables

CMN.02.T14.072PGZE		Grey	
CMN.02.T14.072PNZE		Black	
CMN.02.T14.072QGZE	TPR (medical)	Grey	
CMN.02.T14.078PGZE		Grey	
CMN.02.T14.078PNZE			
CMN.02.T18.064UNCU			
CMN.02.T20.047PGZE		Grey	
CMN.02.T20.047PNZE			
CMN.02.T20.048QGZE	TPR (medical)	Grey	
CMN.02.T28.030PGCE	PVC	GREY	
CMN.02.T28.030PGZE		Grey	
CMN.02.T28.030PNCE	PVC	Black	
CMN.02.T28.030PNZE			
102080	PVC	Grey	
120184	PVC	Black	
120240	PVC	Black	
120250	PVC	Grey	
120500	PVC	Grey	
120501	PVC	Grey	
120751	PVC	Grey	
20140	PVC	Grey	
20140	PVC	Grey	
20141	PVC	Grey	
20142	PVC	Red	
20143	PVC	Green	
20144	PVC	Black	
20145	PVC	Yellow	
20146	PVC	Black	
20240	PTFE	White	
20260	PVC	Black	
20264	PVC	Black	
20266	PVC	Violet	
2050	PVC	Black	
20550	PUR	Black	
20560	PUR	White	
2080	PVC	Grey	

LEMO products and services are provided "as is". LEMO makes no warranties or representations with regard to LEMO product & services or use of them, express, implied or statutory, including for accuracy, completeness, or security. The user is fully responsible for his products and applications using LEMO components.

220151	PVC	Grey	
220750	PVC	Grey	
2221	PVC	Black	
2260	PTFE	White	
2280	PVC	Black	
320150	PVC	Grey	
4082	PVC	Grey	
CMB.02.210.635	PUR	Black	

LEMO products and services are provided "as is". LEMO makes no warranties or representations with regard to LEMO product & services or use of them, express, implied or statutory, including for accuracy, completeness, or security. The user is fully responsible for his products and applications using LEMO components.