

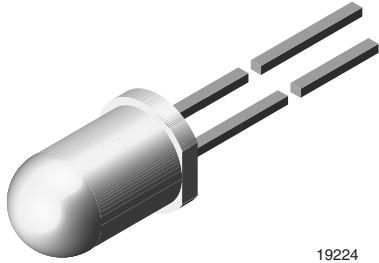

## High Efficiency LED in Ø 5 mm Tinted Diffused Package



19224

### DESCRIPTION

The TLH.640. series was developed for standard applications like general indicating and lighting purposes.

It is housed in a 5 mm tinted diffused plastic package. The wide viewing angle of these devices provides a high on-off contrast.

Several selection types with different luminous intensities are offered. All LEDs are categorized in luminous intensity groups. The green and yellow LEDs are categorized additionally in wavelength groups.

That allows users to assemble LEDs with uniform appearance.

### PRODUCT GROUP AND PACKAGE DATA

- Product group: LED
- Package: 5 mm
- Product series: standard
- Angle of half intensity:  $\pm 30^\circ$

### FEATURES

- Choice of three bright colors
- Standard T-1 $\frac{1}{4}$  package
- Small mechanical tolerances
- Suitable for DC and high peak current
- Wide viewing angle
- Luminous intensity categorized
- Yellow and green color categorized
- TLH.640. without stand-offs
- Material categorization: for definitions of compliance please see [www.vishay.com/doc?99912](http://www.vishay.com/doc?99912)



### APPLICATIONS

- Status lights
- Off / on indicator
- Background illumination
- Readout lights
- Maintenance lights
- Legend light

PARTS TABLE														
PART	COLOR	LUMINOUS INTENSITY (mcd)			at I <sub>F</sub> (mA)	WAVELENGTH (nm)			at I <sub>F</sub> (mA)	FORWARD VOLTAGE (V)			at I <sub>F</sub> (mA)	TECHNOLOGY
		MIN.	TYP.	MAX.		MIN.	TYP.	MAX.		MIN.	TYP.	MAX.		
TLHR6400	Red	1.6	10	-	10	612	-	630	10	-	2	3	20	GaAsP on GaP
TLHR6400-CS12Z	Red	1.6	10	-	10	612	-	630	10	-	2	3	20	GaAsP on GaP
TLHR6401	Red	4	12	-	10	612	-	630	10	-	2	3	20	GaAsP on GaP
TLHR6405	Red	6.3	14	-	10	612	-	630	10	-	2	3	20	GaAsP on GaP
TLHR6405-ASZ	Red	6.3	14	-	10	612	-	630	10	-	2	3	20	GaAsP on GaP
TLHY6400	Yellow	1.6	10	-	10	581	-	594	10	-	2.4	3	20	GaAsP on GaP
TLHY6400-CS12Z	Yellow	1.6	10	-	10	581	-	594	10	-	2.4	3	20	GaAsP on GaP
TLHY6400-MS12Z	Yellow	1.6	10	-	10	581	-	594	10	-	2.4	3	20	GaAsP on GaP
TLHY6401	Yellow	4	12	-	10	581	-	594	10	-	2.4	3	20	GaAsP on GaP
TLHY6405	Yellow	6.3	14	-	10	581	-	594	10	-	2.4	3	20	GaAsP on GaP
TLHY6405-ASZ	Yellow	6.3	14	-	10	581	-	594	10	-	2.4	3	20	GaAsP on GaP
TLHG6400	Green	1.6	10	-	10	562	-	575	10	-	2.4	3	20	GaP on GaP
TLHG6400-AS12Z	Green	1.6	10	-	10	562	-	575	10	-	2.4	3	20	GaP on GaP
TLHG6400-CS12Z	Green	1.6	10	-	10	562	-	575	10	-	2.4	3	20	GaP on GaP
TLHG6401	Green	4	12	-	10	562	-	575	10	-	2.4	3	20	GaP on GaP
TLHG6401-AS12Z	Green	4	12	-	10	562	-	575	10	-	2.4	3	20	GaP on GaP
TLHG6405	Green	6.3	15	-	10	562	-	575	10	-	2.4	3	20	GaP on GaP
TLHG6405-ASZ	Green	6.3	15	-	10	562	-	575	10	-	2.4	3	20	GaP on GaP

**ABSOLUTE MAXIMUM RATINGS** ( $T_{amb} = 25\text{ }^{\circ}\text{C}$ , unless otherwise specified)  
**TLHR640., TLHY640., TLHG640.**

PARAMETER	TEST CONDITION	SYMBOL	VALUE	UNIT
Reverse voltage		$V_R$	6	V
DC forward current	$T_{amb} \leq 65\text{ }^{\circ}\text{C}$	$I_F$	30	mA
Surge forward current	$t_p \leq 10\text{ }\mu\text{s}$	$I_{FSM}$	1	A
Power dissipation	$T_{amb} \leq 65\text{ }^{\circ}\text{C}$	$P_V$	100	mW
Junction temperature		$T_j$	100	$^{\circ}\text{C}$
Operating temperature range		$T_{amb}$	-40 to +100	$^{\circ}\text{C}$
Storage temperature range		$T_{stg}$	-55 to +100	$^{\circ}\text{C}$
Soldering temperature	$t \leq 5\text{ s}$ , 2 mm from body	$T_{sd}$	260	$^{\circ}\text{C}$
Thermal resistance junction-to-ambient		$R_{thJA}$	350	K/W

**OPTICAL AND ELECTRICAL CHARACTERISTICS** ( $T_{amb} = 25\text{ }^{\circ}\text{C}$ , unless otherwise specified)  
**TLHR640., RED**

PARAMETER	TEST CONDITION	PART	SYMBOL	MIN.	TYP.	MAX.	UNIT
Luminous intensity <sup>(1)</sup>	$I_F = 10\text{ mA}$	TLHR6400	$I_V$	1.6	10	-	mcd
		TLHR6401	$I_V$	4	12	-	mcd
		TLHR6405	$I_V$	6.3	14	-	mcd
Dominant wavelength	$I_F = 10\text{ mA}$		$\lambda_d$	612	-	630	nm
Peak wavelength	$I_F = 10\text{ mA}$		$\lambda_p$	-	635	-	nm
Angle of half intensity	$I_F = 10\text{ mA}$		$\phi$	-	$\pm 30$	-	$^{\circ}$
Forward voltage	$I_F = 20\text{ mA}$		$V_F$	-	2	3	V
Reverse voltage	$I_R = 10\text{ }\mu\text{A}$		$V_R$	6	15	-	V
Junction capacitance	$V_R = 0\text{ V}$ , $f = 1\text{ MHz}$		$C_j$	-	50	-	pF

**Note**(1) In one packing unit  $I_{Vmin.}/I_{Vmax.} \leq 0.5$ **OPTICAL AND ELECTRICAL CHARACTERISTICS** ( $T_{amb} = 25\text{ }^{\circ}\text{C}$ , unless otherwise specified)  
**TLHY640., YELLOW**

PARAMETER	TEST CONDITION	PART	SYMBOL	MIN.	TYP.	MAX.	UNIT
Luminous intensity <sup>(1)</sup>	$I_F = 10\text{ mA}$	TLHY6400	$I_V$	1.6	10	-	mcd
		TLHY6401	$I_V$	4	12	-	mcd
		TLHY6405	$I_V$	6.3	14	-	mcd
Dominant wavelength	$I_F = 10\text{ mA}$		$\lambda_d$	581	-	594	nm
Peak wavelength	$I_F = 10\text{ mA}$		$\lambda_p$	-	585	-	nm
Angle of half intensity	$I_F = 10\text{ mA}$		$\phi$	-	$\pm 30$	-	$^{\circ}$
Forward voltage	$I_F = 20\text{ mA}$		$V_F$	-	2.4	3	V
Reverse voltage	$I_R = 10\text{ }\mu\text{A}$		$V_R$	6	15	-	V
Junction capacitance	$V_R = 0\text{ V}$ , $f = 1\text{ MHz}$		$C_j$	-	50	-	pF

**Note**(1) In one packing unit  $I_{Vmin.}/I_{Vmax.} \leq 0.5$ **OPTICAL AND ELECTRICAL CHARACTERISTICS** ( $T_{amb} = 25\text{ }^{\circ}\text{C}$ , unless otherwise specified)  
**TLHG640., GREEN**

PARAMETER	TEST CONDITION	PART	SYMBOL	MIN.	TYP.	MAX.	UNIT
Luminous intensity <sup>(1)</sup>	$I_F = 10\text{ mA}$	TLHG6400	$I_V$	1.6	10	-	mcd
		TLHG6401	$I_V$	4	12	-	mcd
		TLHG6405	$I_V$	6.3	15	-	mcd
Dominant wavelength	$I_F = 10\text{ mA}$		$\lambda_d$	562	-	575	nm
Peak wavelength	$I_F = 10\text{ mA}$		$\lambda_p$	-	565	-	nm
Angle of half intensity	$I_F = 10\text{ mA}$		$\phi$	-	$\pm 30$	-	$^{\circ}$
Forward voltage	$I_F = 20\text{ mA}$		$V_F$	-	2.4	3	V
Reverse voltage	$I_R = 10\text{ }\mu\text{A}$		$V_R$	6	15	-	V
Junction capacitance	$V_R = 0\text{ V}$ , $f = 1\text{ MHz}$		$C_j$	-	50	-	pF

**Note**(1) In one packing unit  $I_{Vmin.}/I_{Vmax.} \leq 0.5$

**TYPICAL CHARACTERISTICS** ( $T_{amb} = 25\text{ }^{\circ}\text{C}$ , unless otherwise specified)

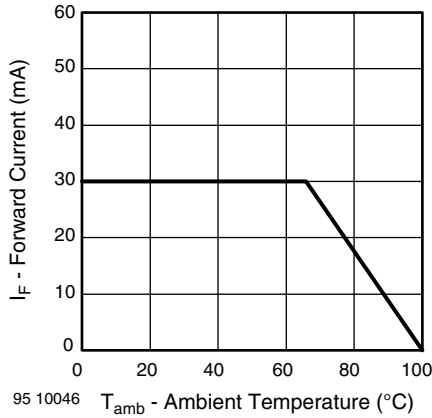

Fig. 1 - Forward Current vs. Ambient Temperature

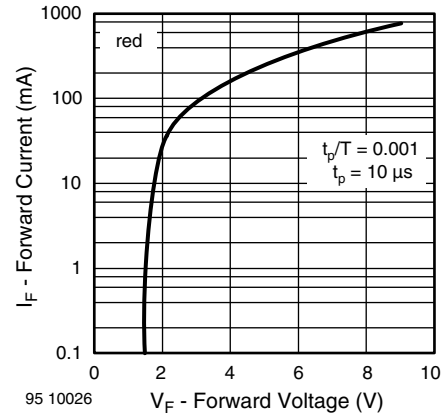

Fig. 4 - Forward Current vs. Forward Voltage

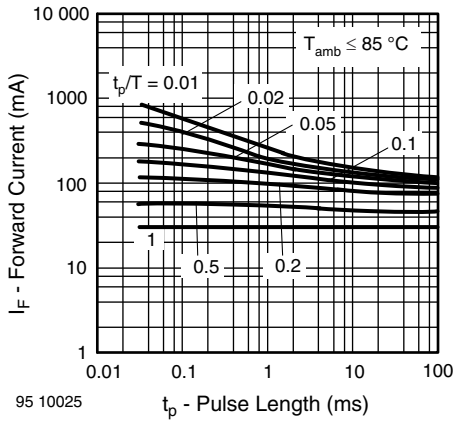

Fig. 2 - Forward Current vs. Pulse Length

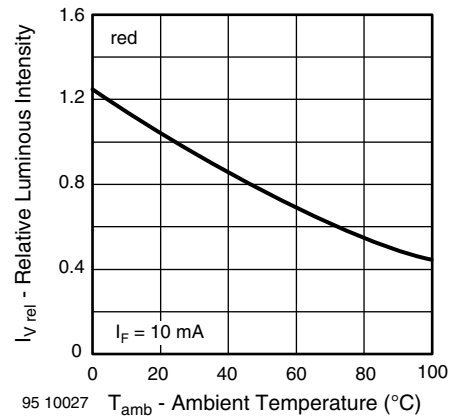

Fig. 5 - Relative Luminous Intensity vs. Ambient Temperature

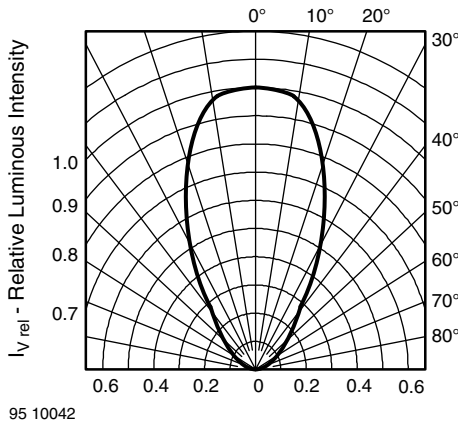

Fig. 3 - Relative Luminous Intensity vs. Angular Displacement

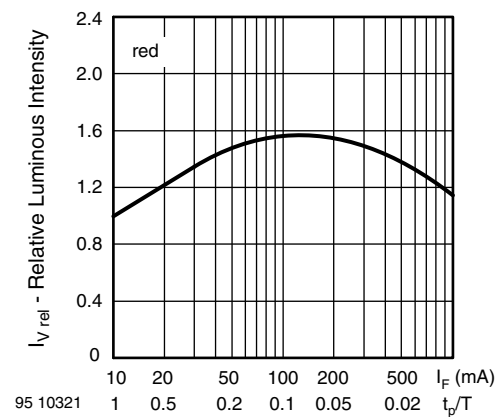

Fig. 6 - Relative Luminous Intensity vs. Forward Current/Duty Cycle

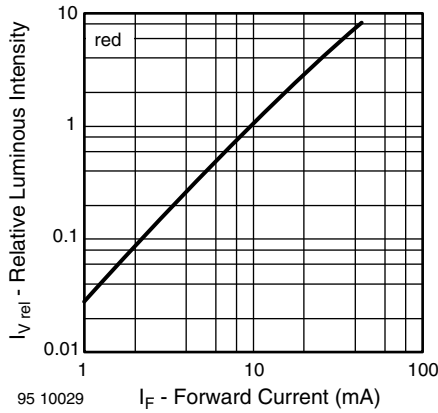

Fig. 7 - Relative Luminous Intensity vs. Forward Current

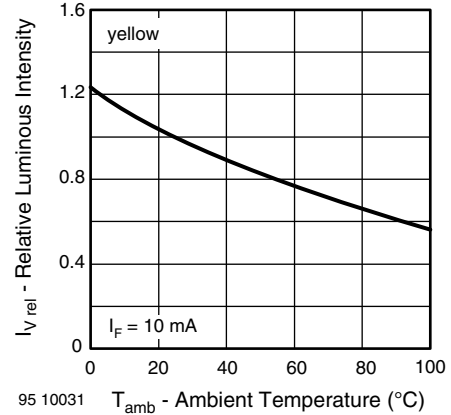

Fig. 10 - Relative Luminous Intensity vs. Ambient Temperature

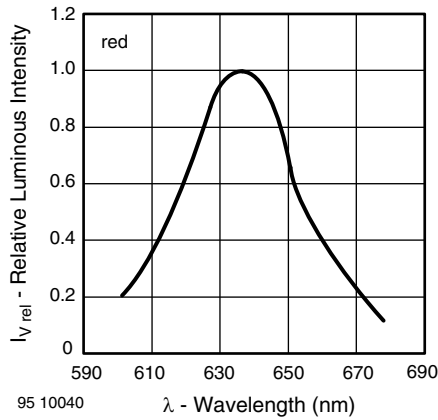

Fig. 8 - Relative Intensity vs. Wavelength

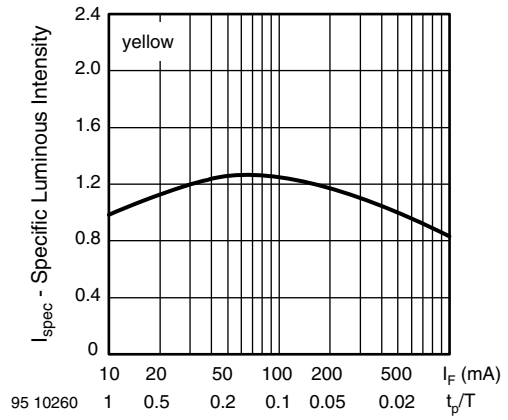

Fig. 11 - Relative Luminous Intensity vs. Forward Current/Duty Cycle

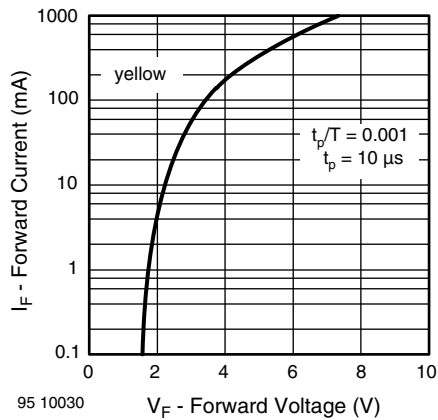

Fig. 9 - Forward Current vs. Forward Voltage

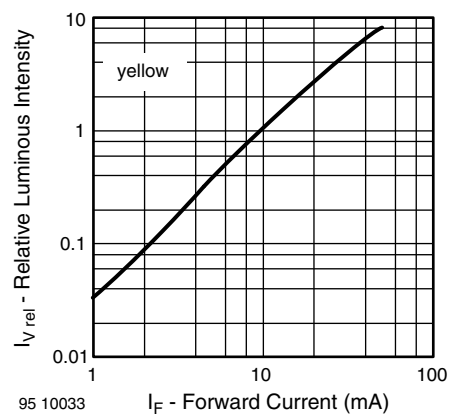

Fig. 12 - Relative Luminous Intensity vs. Forward Current

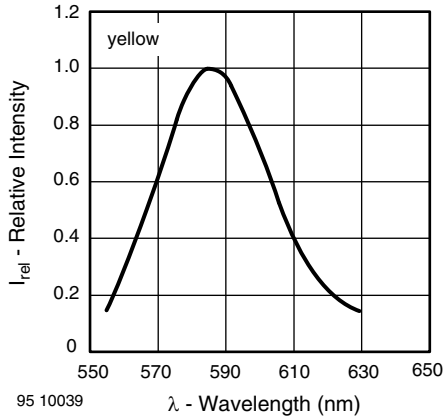

Fig. 13 - Relative Intensity vs. Wavelength

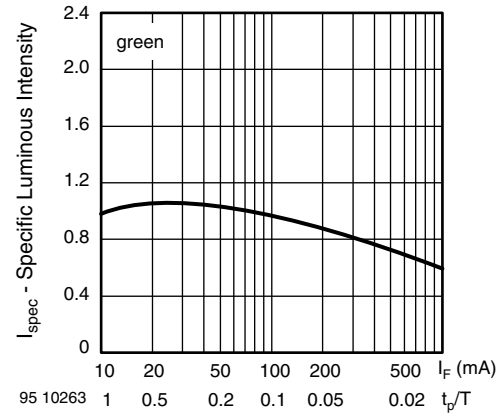

Fig. 16 - Specific Luminous Intensity vs. Forward Current

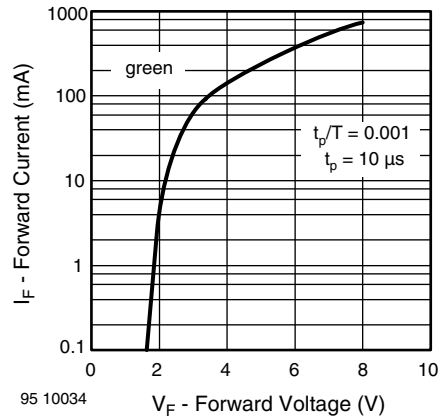

Fig. 14 - Forward Current vs. Forward Voltage

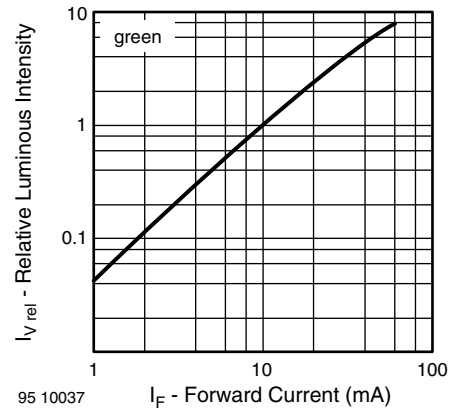

Fig. 17 - Relative Luminous Intensity vs. Forward Current

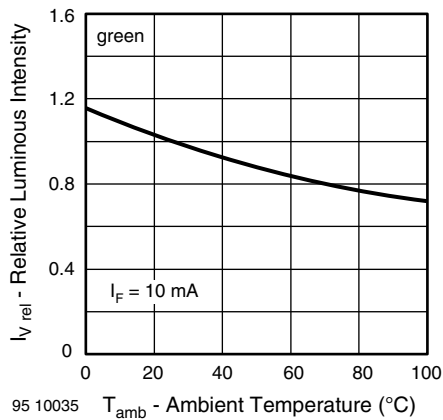

Fig. 15 - Relative Luminous Intensity vs. Ambient Temperature

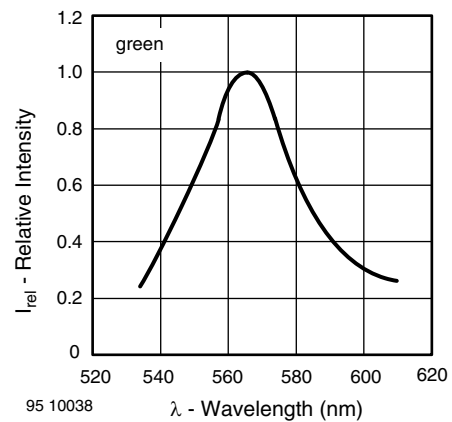
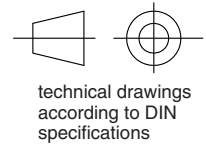
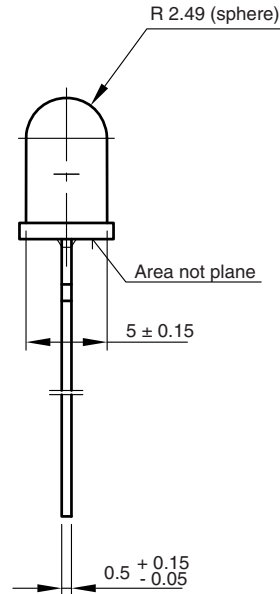
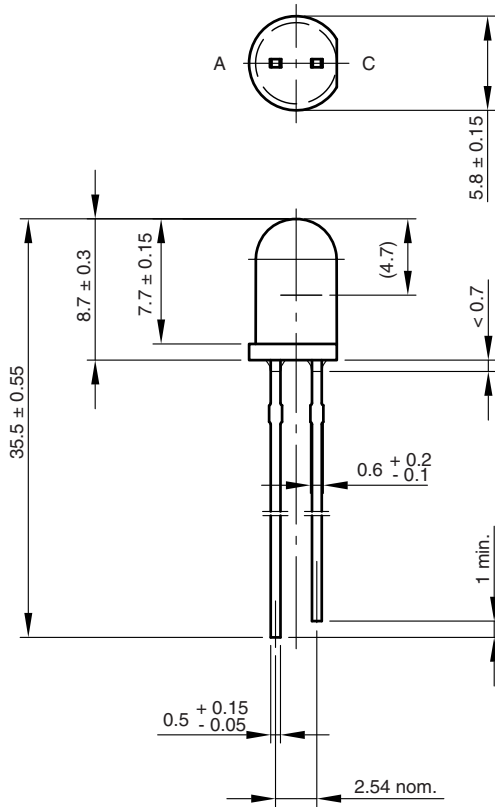

Fig. 18 - Relative Intensity vs. Wavelength



PACKAGE DIMENSIONS in millimeters



6.544-5259.02-4  
 Issue: 8; 19.05.09  
 95 10917

REEL

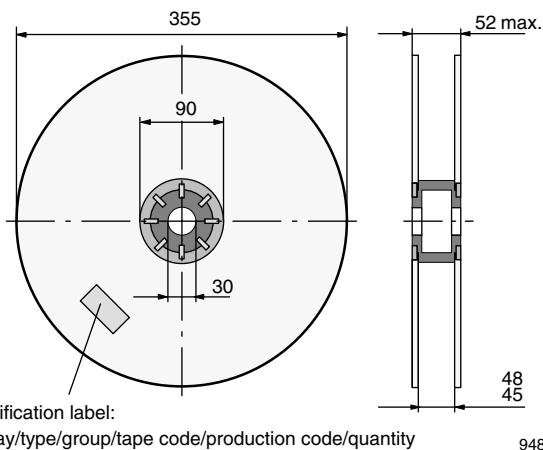

Fig. 19 - Reel Dimensions

TAPE

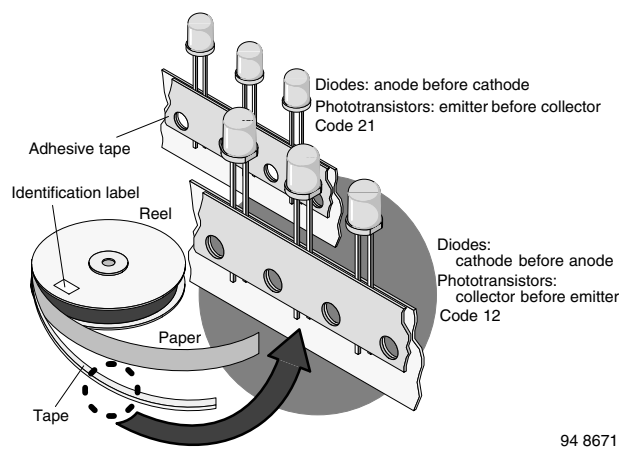
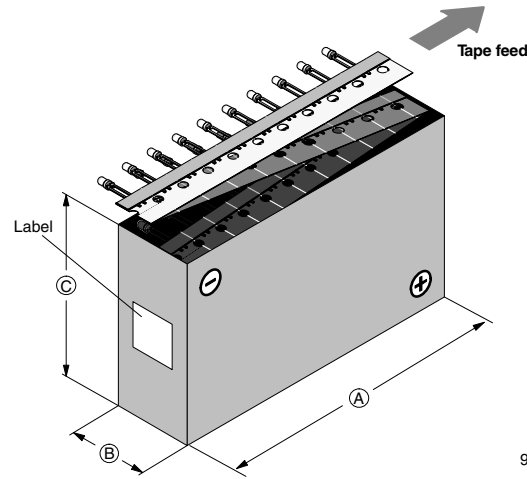

Fig. 20 - LED in Tape

AS12 = cathode leaves tape first  
 AS21 = anode leaves tape first

**AMMOPACK**



94 8667-1

Fig. 21 - Tape Direction

**Note**

- The new nomenclature for ammpack is e.g. ASZ only, without suffix for the LED orientation. The carton box has to be turned to the desired position: "+" for anode first, or "-" for cathode first. AS12Z and AS21Z are still valid for already existing types, BUT NOT FOR NEW DESIGN

**TAPE DIMENSIONS** in millimeters

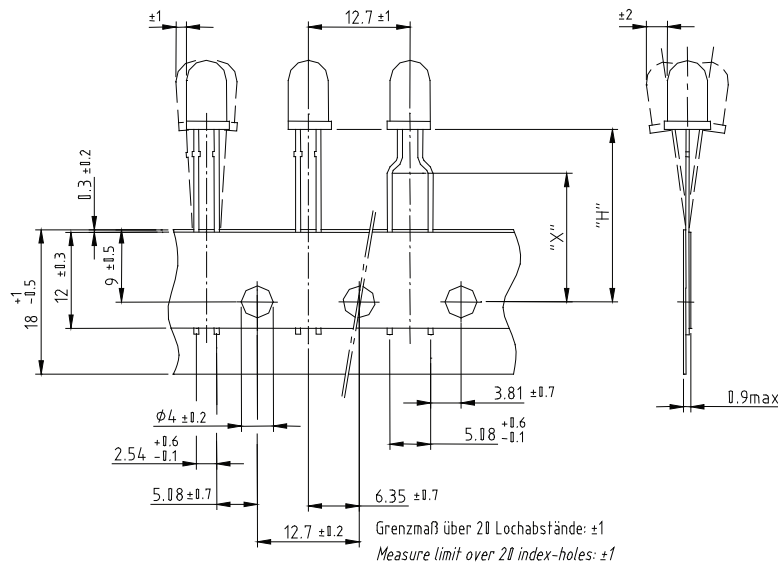

Quantity per:	Ampmpack/reel (Mat.-No. 1764)
	1000

948172\_1

Option	Dim. "H" ± 0.5 mm	Dim. "X" ± 0.5 mm
AS	17.3	
BT	20.0	16.0
CS	22.0	
MS	25.5	



## **Disclaimer**

ALL PRODUCT, PRODUCT SPECIFICATIONS AND DATA ARE SUBJECT TO CHANGE WITHOUT NOTICE TO IMPROVE RELIABILITY, FUNCTION OR DESIGN OR OTHERWISE.

Vishay Intertechnology, Inc., its affiliates, agents, and employees, and all persons acting on its or their behalf (collectively, "Vishay"), disclaim any and all liability for any errors, inaccuracies or incompleteness contained in any datasheet or in any other disclosure relating to any product.

Vishay makes no warranty, representation or guarantee regarding the suitability of the products for any particular purpose or the continuing production of any product. To the maximum extent permitted by applicable law, Vishay disclaims (i) any and all liability arising out of the application or use of any product, (ii) any and all liability, including without limitation special, consequential or incidental damages, and (iii) any and all implied warranties, including warranties of fitness for particular purpose, non-infringement and merchantability.

Statements regarding the suitability of products for certain types of applications are based on Vishay's knowledge of typical requirements that are often placed on Vishay products in generic applications. Such statements are not binding statements about the suitability of products for a particular application. It is the customer's responsibility to validate that a particular product with the properties described in the product specification is suitable for use in a particular application. Parameters provided in datasheets and / or specifications may vary in different applications and performance may vary over time. All operating parameters, including typical parameters, must be validated for each customer application by the customer's technical experts. Product specifications do not expand or otherwise modify Vishay's terms and conditions of purchase, including but not limited to the warranty expressed therein.

Except as expressly indicated in writing, Vishay products are not designed for use in medical, life-saving, or life-sustaining applications or for any other application in which the failure of the Vishay product could result in personal injury or death. Customers using or selling Vishay products not expressly indicated for use in such applications do so at their own risk. Please contact authorized Vishay personnel to obtain written terms and conditions regarding products designed for such applications.

No license, express or implied, by estoppel or otherwise, to any intellectual property rights is granted by this document or by any conduct of Vishay. Product names and markings noted herein may be trademarks of their respective owners.