

750 Watts

- 200 - 425VDC Input Range
- Single Output
- Output Trim -40% to +10%
- Industry Standard Full Brick Package
- 3kVAC Isolation Reinforced
- Remote On/Off
- Current Share and Power Good Signals
- -40°C to +85°C Operation
- 3 Year Warranty

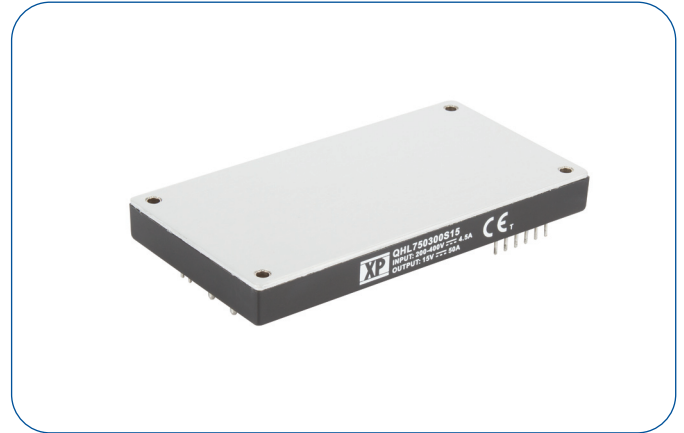

Dimensions:

QHL750:

4.6 x 2.4 x 0.5" (116.8 x 61.0 x 12.7 mm)

The QHL750 extends the product range of high voltage input DC-DC modules to 750W in a full brick module. This series of modules enables effective construction of distributed power architectures from AC front ends, PFC front ends and battery systems.

Models & Ratings

Input Voltage	Output Voltage	Output Current	Input Current ⁽¹⁾		Ripple & noise ⁽²⁾	Efficiency ⁽¹⁾	Max. capacitive load ⁽³⁾	Model Number
			No Load	Full Load				
300V (200-425V)	12V	62.5A	10mA	2.79A	300mV	89.5%	10000µF	QHL750300S12
	15V	50.0A	10mA	2.81A	300mV	89.0%	10000µF	QHL750300S15
	24V	31.2A	10mA	2.78A	400mV	90.0%	10000µF	QHL750300S24
	28V	26.7A	10mA	2.73A	400mV	90.5%	10000µF	QHL750300S28
	48V	15.6A	10mA	2.75A	650mV	91.0%	8000µF	QHL750300S48

Notes

1. Measured at 300VDC input.
2. Peak to peak measured at 20MHz bandwidth and 1000µF electrolytic/1µF ceramic capacitors.
3. Recommended input capacitance of 330µF required to reduce input ripple voltage at -40°C operation or 150µF for operation to -20°C. See application notes.
4. Optional negative logic add suffix -N for module enable/disable function. See output table.

Mechanical Details

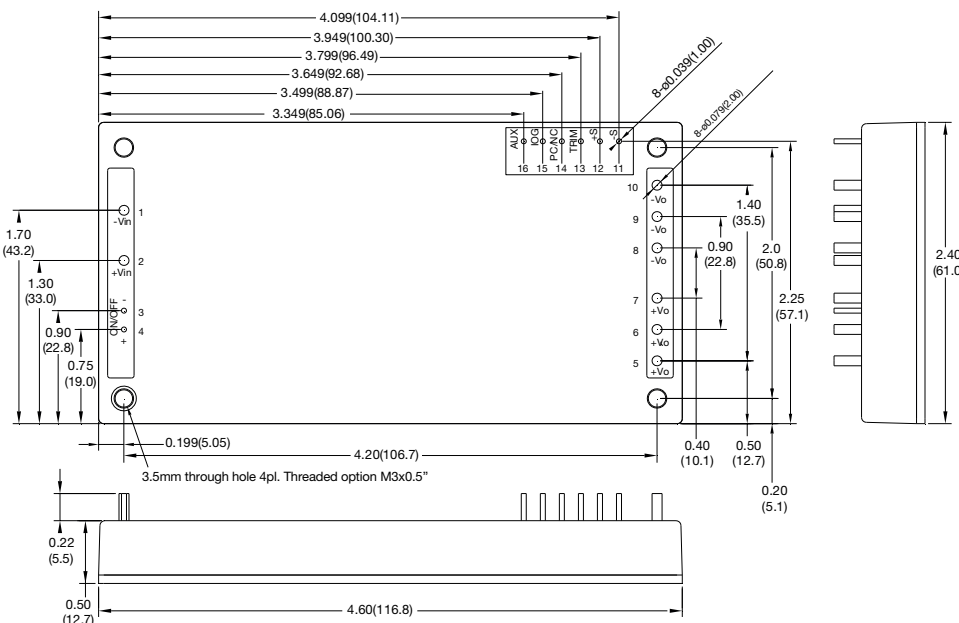

Pin Connections	
Pin	Function
1	-Vin
2	+Vin
3	-REM
4	+REM
5-7	+Vout
8-10	-Vout
11	-Sense
12	+Sense
13	Trim
14	Current Share
15	Power Good
16	Auxiliary, 7-13V/20mA

Notes

1. All dimensions are in inches (mm)
2. Weight: 0.51 lbs (230 g) approx.
3. Tolerance: x.xx = ±0.02 (x.x = ±0.5)
x.xxx = ±0.01 (x.xx = ±0.25)
4. Optional M3 x 0.5 threaded baseplate fixing add suffix -T.

Input

Characteristic	Minimum	Typical	Maximum	Units	Notes & Conditions
Input Voltage Range	200		425	VDC	
Input Current	1.8		3.9	A	200-425VDC input.
Input Surge			475	VDC	For 100ms.
Undervoltage Lockout	>185	190	195	VDC	On.
	<175	480	185		Off.
Lockout Hysteresis		10		VDC	
Input Transient Voltage			475	VDC	For 100ms.
Input Overvoltage Lockout		480/500		VDC	Module On / Module Off.
Idle Current		10		mA	When output is remotely turned off.
Inrush Current			0.1	A ² s	
Recommended Input Fuse		10		A	Fast acting type.
Input Reflected Ripple Current			50	mA pk-pk	Through 10 μ H inductor.

Output

Characteristic	Minimum	Typical	Maximum	Units	Notes & Conditions
Output Voltage	12		48	VDC	See Models and Ratings table.
Output Trim	-40		+10	%	See Application Note.
Initial Set Accuracy			± 1.0	%	At full load and 36V input.
Minimum Load	0			%	No minimum load required.
Line Regulation			± 0.2	%	From minimum to maximum input at full load.
Load Regulation			± 0.5	%	From 0% to full load.
Transient Response		± 3.0	± 5.0	%	Maximum deviation, recovering to less than 1% in 500 μ s for 25% step load change.
Start Up Time			700	ms	
Output Voltage Rise Time		40		ms	
Ripple & Noise				mV pk-pk	See models and ratings table.
Overload Protection	105		125	%	
Short Circuit Protection					Continuous hiccup mode, with auto recovery.
Maximum Capacitive Load					See Models and Ratings table. Minimum capacitance of 1000 μ F required to meet specified regulations.
Temperature Coefficient			0.03	%/ $^{\circ}$ C	
Overvoltage Protection	115	125	140	%	
Remote On/Off	Output is on if REM+ (pin 4) is open or high (3.5-75VDC) with respect to REM- (pin 3) or -Vin. Output turns off if REM+ (pin 4) is low (<1.2VDC max) with respect to REM- (pin 3) or -Vin (see application notes). Default positive logic, for negative logic add suffix -N.				

General

Characteristic	Minimum	Typical	Maximum	Units	Notes & Conditions
Efficiency		90		%	See Models and Ratings table.
Isolation: Input to Output	3000			VAC	60s qualification. Reinforced insulation.
Isolation: Input to Case	2500			VAC	60s qualification. Basic insulation.
Isolation: Output to Case	500			VAC	60s qualification. Functional insulation.
Switching Frequency		200		kHz	Fixed, $\pm 15\%$.
Isolation Resistance	10 ⁹			Ω	
Power Density			135	W/in ³	
Mean Time Between Failure		370		kHrs	MIL-HDBK-217F, +25 $^{\circ}$ C GB.
Pin Material	Copper with nickel and matte tin plating				
Case Material	Plastic (DAP) with aluminium, UL94V-0				
Potting Material	Epoxy, UL94V-0				
Solder Profile			260	$^{\circ}$ C	Above 250 $^{\circ}$ C. 3-6s. With iron 450 $^{\circ}$ C for <5s.
Water Wash	Use deionized water, do not soak. Dry thoroughly				
Weight		0.51 (230.0)		lb (g)	

Environmental

Characteristic	Minimum	Typical	Maximum	Units	Notes & Conditions
Operating Base Plate Temperature	-40		+85	$^{\circ}$ C	
Storage Temperature	-55		+105	$^{\circ}$ C	
Thermal Protection		+95		$^{\circ}$ C	Auto recovery at 75 $^{\circ}$ C typical.
Humidity			95	%RH	Non-condensing.
Altitude			2000	m	Operating. Storage to 12000m.
Cooling					Baseplate-cooled.

EMC: Emissions

Phenomenon	Standard	Test Level	Notes & Conditions
Conducted	EN55032	Class A	See Application Notes.
Radiated	EN55032	Class A	

EMC: Immunity

Phenomenon	Standard	Test Level	Criteria	Notes & Conditions
ESD Immunity	EN61000-4-2	±4kV/±8kV	A	Contact Discharge/Air Discharge.
Radiated Immunity	EN61000-4-3	3Vrms	A	
EFT/Burst	EN61000-4-4	1kV	A	Requires VZ1, VZ2, GT1 & GT2 as shown in conducted emission circuit.
Surge	EN61000-4-5	0.5kV	A	Requires VZ1, VZ2, GT1 & GT2 as shown in conducted emission circuit.
Conducted Immunity	EN61000-4-6	3Vrms	A	
Magnetic Fields	EN61000-4-8	3A/m	A	

Safety Approvals

Agency	Standard	Notes & Conditions
CE	LVD	EN62368-1

Mechanical Details

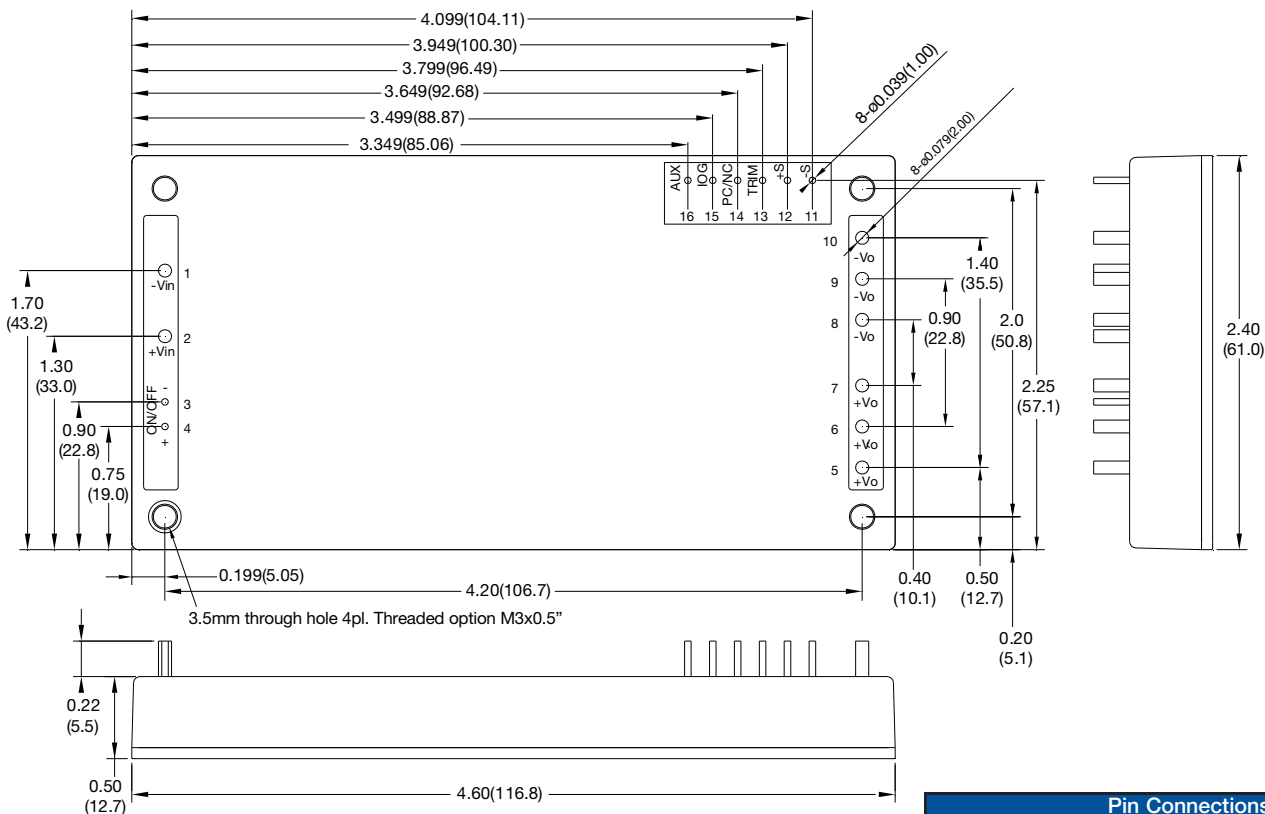

Notes

- All dimensions are in inches (mm)
- Weight: 0.51 lbs (230 g) approx.
- Tolerance: x.xx = ±0.02 (x.x = ±0.5)
x.xxx = ±0.01 (x.xx = ±0.25)
- Optional M3 x 0.5 threaded baseplate fixing add suffix -T.

Pin Connections			
Pin	Function	Pin	Function
1	-Vin	11	-Sense
2	+Vin	12	+Sense
3	-REM	13	Trim
4	+REM	14	Current Share
5-7	+Vout	15	Power Good
8-10	-Vout	16	Auxiliary, 7-13V/20mA

Application Notes

Input Fusing and Safety Considerations

The QHL750 series converters have no internal fuse. In order to achieve maximum safety and system protection, always use an input line fuse. We recommended a 10A fast acting fuse. It is also recommended that the circuit has a transient voltage suppressor diode (TVS) across the input terminals to protect the unit against surge or spike voltages and input reverse voltage (as shown). A suitable part would be SMCJ78A.

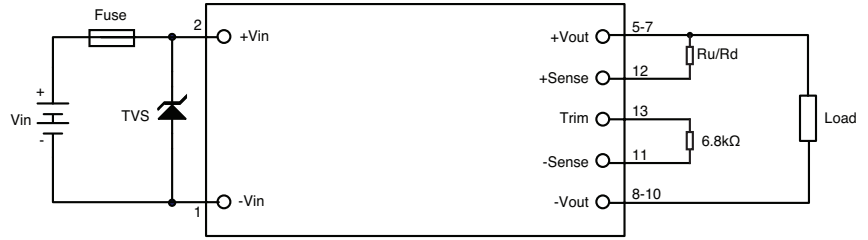

Output Voltage Adjustment

The Trim input permits the user to adjust the output voltage up by 10% or down by 40%. This is accomplished by connecting a mandatory external resistor between the Trim pin and negative sense pin of value 6.8kOhm. Then select Ru or Rd to determine desired output voltage.

Output Voltage Sensing

The module will automatically trim the output voltage via the sense pins to the default values either locally or at the load. If not required, the sense pins should be connected locally as indicated in the example EMC circuit.

To Trim Down (Rd)

Trim Down %	12 V	15 V	24 V	28 V	48 V
	Rtrim_down (kΩ)				
1	10.63	13.29	21.26	24.80	42.51
2	10.40	13.00	20.80	24.27	41.60
3	10.17	12.71	20.34	23.73	40.69
4	9.943	12.43	19.89	23.20	39.77
5	9.714	12.14	19.43	22.67	38.86
6	9.486	11.86	18.97	22.13	37.94
7	9.257	11.57	18.51	21.60	37.03
8	9.029	11.29	18.06	21.07	36.11
9	8.800	11.00	17.60	20.53	35.20
10	8.571	10.71	17.14	20.00	34.29
11	8.343	10.43	16.69	19.47	33.37
12	8.114	10.14	16.23	18.93	32.46
13	7.886	9.857	15.77	18.40	31.54
14	7.657	9.571	15.31	17.87	30.63
15	7.429	9.286	14.86	17.33	29.71
16	7.200	9.000	14.40	16.80	28.80
17	6.971	8.714	13.94	16.27	27.89
18	6.743	8.429	13.49	15.73	26.97
19	6.514	8.143	13.03	15.20	26.06
20	6.286	7.857	12.57	14.67	25.14
21	6.057	7.571	12.11	14.13	24.23
22	5.829	7.286	11.66	13.60	23.31
23	5.600	7.000	11.20	13.07	22.40
24	5.371	6.714	10.74	12.53	21.49
25	5.143	6.429	10.29	12.00	20.57
26	4.914	6.143	9.829	11.47	19.66
27	4.686	5.857	9.371	10.93	18.74
28	4.457	5.571	8.914	10.40	17.83
29	4.229	5.286	8.457	9.867	16.91
30	4.000	5.000	8.000	9.333	16.00
31	3.771	4.714	7.543	8.800	15.09
32	3.543	4.429	7.086	8.267	14.17
33	3.314	4.143	6.629	7.733	13.26
34	3.086	3.857	6.171	7.200	12.34
35	2.857	3.571	5.714	6.667	11.43
36	2.629	3.286	5.257	6.133	10.51
37	2.400	3.000	4.800	5.600	9.600
38	2.171	2.714	4.343	5.067	8.686
39	1.943	2.429	3.886	4.533	7.771
40	1.714	2.143	3.429	4.000	6.857

To Trim Up (Ru)

Trim Up %	12 V	15 V	24 V	28 V	48 V
	Rtrim_up (kΩ)				
1	11.09	13.86	22.17	25.87	44.34
2	11.31	14.14	22.63	26.40	45.26
3	11.54	14.43	23.09	26.93	46.17
4	11.77	14.71	23.54	27.47	47.09
5	12.00	15.00	24.00	28.00	48.00
6	12.23	15.29	24.46	28.53	48.91
7	12.46	15.57	24.91	29.07	49.83
8	12.69	15.86	25.37	29.60	50.74
9	12.91	16.14	25.83	30.13	51.66
10	13.14	16.43	26.29	30.67	52.57

Power Good Signal

Open collector output, referenced to -Sense Pin. Output is pulled low if DC/DC is operating normally and floating if DC/DC is remotely turned off or operating abnormally.

Application Notes

Thermal Resistance Information

Airflow Derating Graph - Without Heatsink

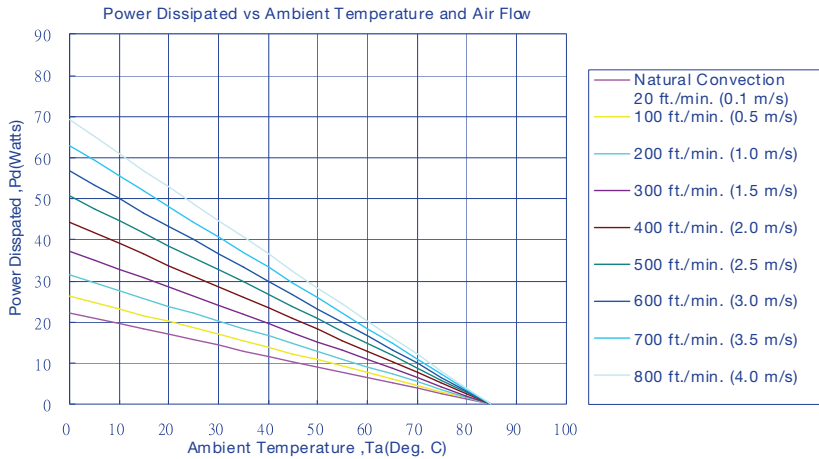

Air Flow Rate	Typical Rca
Natural Convection 20 ft/min (0.1 m/s)	3.82 °C/W
100 ft/min (0.5 m/s)	3.23 °C/W
200 ft/min (1.0 m/s)	2.71 °C/W
300 ft/min (1.5 m/s)	2.28 °C/W
400 ft/min (2.0 m/s)	1.92 °C/W
500 ft/min (2.5 m/s)	1.68 °C/W
600 ft/min (2.5 m/s)	1.50 °C/W
700 ft/min (2.5 m/s)	1.35 °C/W
800 ft/min (2.5 m/s)	1.23 °C/W

Example (Without Heatsink)

To determine the minimum airflow necessary for a QHL750300S48 operating at an input voltage of 300 V, an output current of 11A, and a maximum ambient temperature of 25°C:

Determine Power dissipation (Pd): $Pd = Pi - Po = Po(1-\eta)/\eta$,

$$Pd = 48V \times 11A \times (1-0.91) / 0.91 = 47.47W$$

Where Pi = Input power, Po = Output Power and η = Efficiency

Determine airflow from airflow derating graph using data points for Pd = 47.4W and Ta = 25°C

Minimum airflow= 800ft./min.

To check that the maximum case temp of 85°C is not exceeded:

Maximum temperature rise is

$$\Delta T = Pd \times Rca = 47.47 \times 1.23 = 58.38^\circ C.$$

Maximum case temperature is

$$Tc = Ta + \Delta T = 83.38^\circ C < 85^\circ C.$$

Where: Rca is the thermal resistance from case to ambient environment. Ta is ambient temperature and Tc is case temperature.

Remote Control

Example application circuits

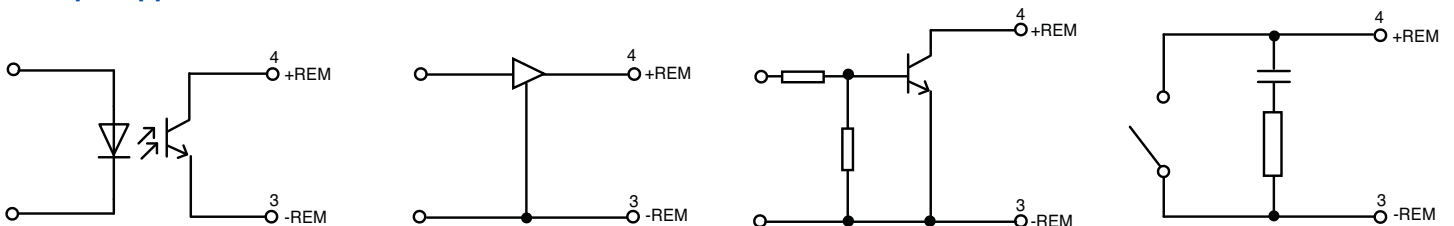

Application Notes

EMC Considerations

Connection circuit for EMI test standard: EN55022/55032 Class A conducted emissions

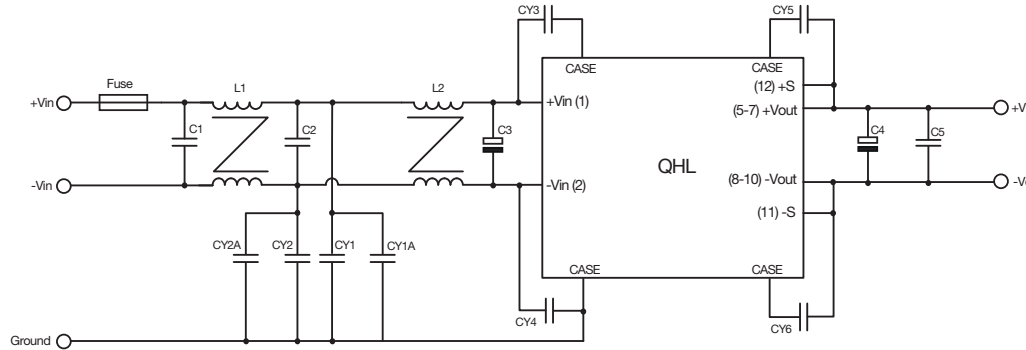

Model Number	C1	C2	C3	C4	C5	CY1	CY1A	CY2	CY2A	CY3	CY4	CY5	CY6	L1	L2
QHL750300Sxx	0.68µF/ 305VAC/630VDC	0.68µF/ 305VAC/630VDC	330µF/ 450V	820µF/ 63V	1µF/ 100V	2200pF	470pF	2200 pF	470pF	2200pF	2200pF	0.022µF	0.022µF	4.2mH	4.2mH

Notes

C3 and C4: aluminium electrolytic capacitors

C3: is recommended to be 330µF 450V for operation to -40°C type Nippon Chemi-Con KXG series or equivalent. The value of C3 can be reduced to 150µF for operation to -20°C.

C4: 820µF / 63V Rubycon ZLH series or equivalent

CY1, CY1A, CY2, CY2A, CY3 and CY4: Ceramic TDK CD series or equivalent.

C5: Ceramic TDK CGA series or equivalent

C1, C2, CY5 and CY6: 0.68µF / 305VAC X2 rated MKP series, 0.022µF / 275VAC X2 rated MPX series – or equivalent

L1, L2: 4.2 mH (VAKOS T25*15*13 R8K Series 0.8mm/20T) or equivalent.

Safety Considerations

The use of a fuse on the input line is recommended for good practice. Additional protection for surges and reverse voltage are also recommended. Transient voltage suppressors and gas discharge devices can be fitted across the input terminals.

Ground Connection

The above circuit assumes an earth connection is available. If no earth present CY capacitors should be connected to case as shown. CY values might require adjustment depending on the application. Please consult XP Power applications engineering for further support.

Series & Parallel Configurations

Please contact XP Power applications engineering for further details.