

Data sheet | Item number: 279-508

Double-deck terminal block; 4-conductor through terminal block; L; suitable for Ex i applications; internal commoning; conductor entry with violet marking; for DIN-rail 35 x 15 and 35 x 7.5; 1.5 mm²; 1,50 mm²; gray

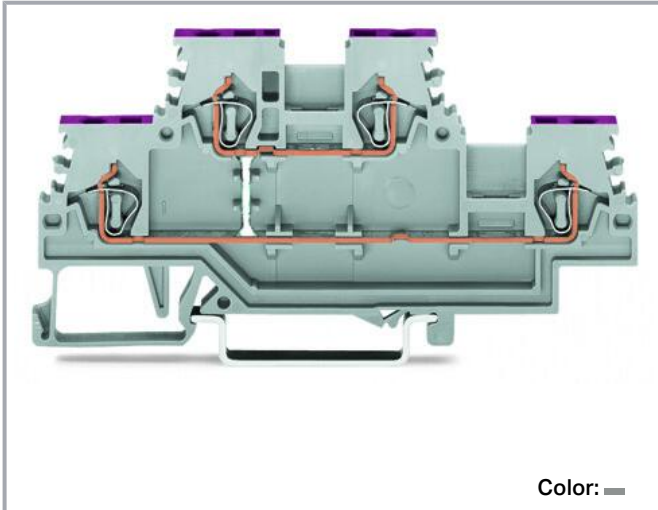

www.wago.com/279-508



Color: —

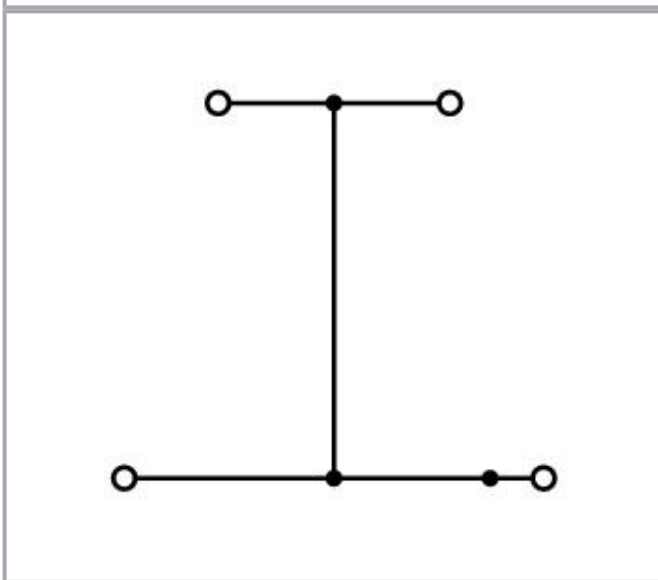
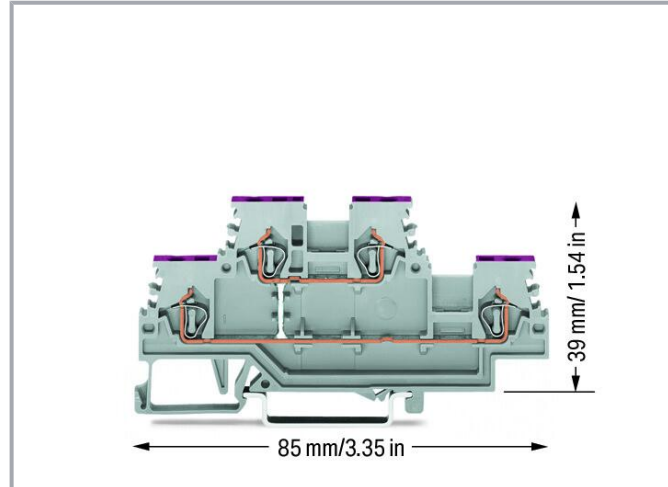

Data

Electrical data

Ratings per IEC/EN

Ratings per

IEC/EN 60947-7-1

Subject to changes. Please also observe the further product documentation!

WAGO GmbH & Co. KG
Hansastr. 27
32423 Minden
Phone: +49571 887-0 | Fax: +49571 887-169
Email: info.de@wago.com | Web: www.wago.com

Do you have any questions about our products?
We are always happy to take your call at +49 (571) 887-44222.



| | |
|-------------------------------|--|
| Nominal voltage (III/3) | 500 V |
| Rated impulse voltage (III/3) | 6 kV |
| Rated current | 18 A |
| Legend (ratings) | (III / 3) \triangleq Overvoltage category III / Pollution degree 3 |

Ratings per UL 1059

| | |
|--------------------------------|---------|
| Approvals per | UL 1059 |
| Rated voltage UL (Use Group C) | 600 V |
| Rated current UL (Use Group C) | 10 A |

Ratings per CSA

| | |
|---------------------------------|-----------------|
| Approvals per | CSA 22.2 No 158 |
| Rated voltage CSA (Use Group C) | 600 V |
| Rated current CSA (Use Group C) | 10 A |

Power loss

| | |
|--|----------------|
| Power loss, per pole (potential) | 0.593 W |
| Rated current I_N for specified power loss | 18 A |
| Resistance value for specified, current-dependent power loss | 0.002 Ω |

Connection data

| | |
|----------------------------|---|
| Connection points | 4 |
| Total number of potentials | 1 |
| Number of levels | 2 |

Connection 1

| | |
|---------------------------------|--|
| Connection technology | CAGE CLAMP [®] |
| Actuation type | Operating tool |
| Connectable conductor materials | Copper |
| Solid conductor | 0.08 ... 1.5 mm ² / 28 ... 16 AWG |
| Fine-stranded conductor | 0.08 ... 1.5 mm ² / 28 ... 16 AWG |
| Strip length | 8 ... 9 mm / 0.31 ... 0.35 inches |
| Wiring direction | Front-entry wiring |

Subject to changes. Please also observe the further product documentation!



Physical data

| | |
|-----------------------------------|----------------------|
| Width | 4 mm / 0.157 inches |
| Height | 85 mm / 3.346 inches |
| Depth from upper-edge of DIN-rail | 39 mm / 1.535 inches |

Mechanical Data

| | |
|-------------------|-----------------|
| Potential marking | L |
| Design | horizontal type |
| Mounting type | DIN-35 rail |
| Marking level | Side marking |

Material Data

| | |
|-----------------------------|--|
| Note (material data) | Information on material specifications can be found here |
| Color | gray |
| Material group | I |
| Insulation material | Polyamide (PA66) |
| Flammability class per UL94 | V0 |
| Fire load | 0.146 MJ |
| Weight | 7.8 g |

Environmental requirements

| | |
|----------------------------------|-----------------|
| Processing temperature | -35 ... +85 °C |
| Continuous operating temperature | -60 ... +105 °C |

Commercial data

| | |
|-------------------|----------------------------------|
| Product Group | 1 (Rail Mounted Terminal Blocks) |
| eCl@ss 10.0 | 27-14-11-20 |
| eCl@ss 9.0 | 27-14-11-20 |
| ETIM 8.0 | EC000897 |
| ETIM 7.0 | EC000897 |
| PU (SPU) | 50 pcs |
| Packaging type | box |
| Country of origin | CN |

Subject to changes. Please also observe the further product documentation!

| | |
|------|---------------|
| GTIN | 4050821237266 |
|------|---------------|





| | |
|-----------------------|-------------|
| Customs tariff number | 85369010000 |
|-----------------------|-------------|

Environmental Product Compliance



| | |
|------------------------|-------------------------|
| RoHS Compliance Status | Compliant, No Exemption |
|------------------------|-------------------------|

Approvals / Certificates

General approvals

| Logo | Approval | Additional Approval Text | Certificate name |
|--|---------------------------------------|--------------------------|------------------|
|  | CCA DEKRA Certification B.V. | EN 60947 | NTR NL-7081 |
|  | CSA DEKRA Certification B.V. | C22.2 No. 158 | 70133738 |
|  | KEMA/KEUR DEKRA Certification B.V. | EN 60947 | 2160584.04 |
|  | UL Underwriters Laboratories Inc. | UL 1059 | E45172 |

Declarations of conformity and manufacturer's declarations

| Logo | Approval | Additional Approval Text | Certificate name |
|--|--|--------------------------|------------------|
|  | EU-Declaration of Conformity WAGO GmbH & Co. KG | - | - |
|  | UK-Declaration of Conformity WAGO GmbH & Co. KG | - | - |

Approvals for marine applications

| Logo | Approval | Additional Approval Text | Certificate name |
|------|----------|--------------------------|------------------|
|------|----------|--------------------------|------------------|

Subject to changes. Please also observe the further product documentation!

WAGO GmbH & Co. KG
 Hansastr. 27
 32423 Minden
 Phone: +49571 887-0 | Fax: +49571 887-169
 Email: info.de@wago.com | Web: www.wago.com

Do you have any questions about our products?
 We are always happy to take your call at +49 (571) 887-44222.



ABS
American Bureau of Shipping

-

20-
HG1941090-
PDA



DNV GL
Det Norske Veritas, Germanischer Lloyd

-

TAE00001V2

Required accessories

End plate

End plate



Item no.: 279-519
End and intermediate plate; 2 mm thick; orange

www.wago.com/279-519



Item no.: 279-518
End and intermediate plate; 2 mm thick; gray

www.wago.com/279-518

Optional accessories

Protective warning marker

Cover



Item no.: 279-415
Protective warning marker; 5-pole; with high-voltage symbol, black; yellow

www.wago.com/279-415

Testing and measuring

Testing accessories



Item no.: 209-170
Test plug adapter; 8.3 mm wide; for 4 mm Ø test plugs; suitable for 1.5 mm² - 10 mm² tbs; gray

www.wago.com/209-170



Item no.: 280-404
Test plug adapter; 5 mm wide; for test plug (2.3 mm Ø); suitable for 1.5 mm² - 4 mm² tbs; gray

www.wago.com/280-404

Push-in type wire jumper

Jumper



Item no.: 249-123
Push-in type wire jumper; 0.75 mm²; insulated; 180 mm long; black

www.wago.com/249-123



Item no.: 249-126
Push-in type wire jumper; 0.75 mm²; insulated; 110 mm long; black

www.wago.com/249-126



Item no.: 249-127
Push-in type wire jumper; 0.75 mm²; insulated; 250 mm long; black

www.wago.com/249-127





Item no.: 249-125
Push-in type wire jumper; insulated; 60 mm long; black

www.wago.com/249-125

Subject to changes. Please also observe the further product documentation!

Tool

Operating tool

| | | |
|--|--|--|
|  | Item no.: 210-648 Operating tool; Blade: 2.5 x 0.4 mm; with a partially insulated shaft; angled; short | www.wago.com/210-648 |
|  | Item no.: 210-647 Operating tool; Blade: 2.5 x 0.4 mm; with a partially insulated shaft; multicoloured | www.wago.com/210-647 |
|  | Item no.: 210-719 Operating tool; Blade: 2.5 x 0.4 mm; with a partially insulated shaft | www.wago.com/210-719 |

Carrier rail

Mounting accessories

| | | |
|--|--|--|
|  | Item no.: 210-197 Steel carrier rail; 35 x 15 mm; 1.5 mm thick; 2 m long; slotted; similar to EN 60715; silver-colored | www.wago.com/210-197 |
|  | Item no.: 210-198 Copper carrier rail; 35 x 15 mm; 2.3 mm thick; 2 m long; unslotted; according to EN 60715; copper-colored | www.wago.com/210-198 |
|  | Item no.: 210-504 Steel carrier rail; 35 x 7.5 mm; 1 mm thick; 2 m long; slotted; galvanized; according to EN 60715; silver-colored | www.wago.com/210-504 |
|  | Item no.: 210-505 Steel carrier rail; 35 x 7.5 mm; 1 mm thick; 2 m long; unslotted; galvanized; according to EN 60715; silver-colored | www.wago.com/210-505 |
|  | Item no.: 210-506 Steel carrier rail; 35 x 15 mm; 1.5 mm thick; 2 m long; unslotted; galvanized; similar to EN 60715; silver-colored | www.wago.com/210-506 |
|  | Item no.: 210-508 Steel carrier rail; 35 x 15 mm; 1.5 mm thick; 2 m long; slotted; galvanized; similar to EN 60715; silver-colored | www.wago.com/210-508 |
|  | Item no.: 210-113 Steel carrier rail; 35 x 7.5 mm; 1 mm thick; 2 m long; unslotted; according to EN 60715; silver-colored | www.wago.com/210-113 |
|  | Item no.: 210-118 Steel carrier rail; 35 x 15 mm; 2.3 mm thick; 2 m long; unslotted; according to EN 60715; silver-colored | www.wago.com/210-118 |
|  | Item no.: 210-112 Steel carrier rail; 35 x 7.5 mm; 1 mm thick; 2 m long; slotted; according to EN 60715; "Hole width 25 mm; silver-colored | www.wago.com/210-112 |
|  | Item no.: 210-114 Steel carrier rail; 35 x 15 mm; 1.5 mm thick; 2 m long; unslotted; similar to EN 60715; silver-colored | www.wago.com/210-114 |
|  | Item no.: 210-115 Steel carrier rail; 35 x 7.5 mm; 1 mm thick; 2 m long; slotted; according to EN 60715; "Hole width 18 mm; silver-colored | www.wago.com/210-115 |

Subject to changes. Please also observe the further product documentation!

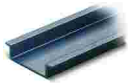

Item no.: 210-196

Aluminum carrier rail; 35 x 8.2 mm; 1.6 mm thick; 2 m long; unslotted; similar to EN 60715; silver-colored

www.wago.com/210-196

Marking accessories

Marker carrier



Item no.: 279-529

Adaptor; gray

www.wago.com/279-529

Double marker carrier



Item no.: 209-128

Adaptor; gray

www.wago.com/209-128

Marker



Item no.: 2009-114/000-002

WMB-Inline; for Smart Printer; 2000 pieces on roll; stretchable 4 - 4.2 mm; plain; snap-on type; yellow

www.wago.com/2009-114/000-002



Item no.: 2009-114/000-005

WMB-Inline; for Smart Printer; 2000 pieces on roll; stretchable 4 - 4.2 mm; plain; snap-on type; red

www.wago.com/2009-114/000-005



Item no.: 2009-114/000-007

WMB-Inline; for Smart Printer; 2000 pieces on roll; stretchable 4 - 4.2 mm; plain; snap-on type; gray

www.wago.com/2009-114/000-007



Item no.: 2009-114/000-023

WMB-Inline; for Smart Printer; 2000 pieces on roll; stretchable 4 - 4.2 mm; plain; snap-on type; green

www.wago.com/2009-114/000-023



Item no.: 2009-114/000-006

WMB-Inline; for Smart Printer; 2000 pieces on roll; stretchable 4 - 4.2 mm; plain; snap-on type; blue

www.wago.com/2009-114/000-006



Item no.: 2009-114/000-024

WMB-Inline; for Smart Printer; 2000 pieces on roll; stretchable 4 - 4.2 mm; plain; snap-on type; violet

www.wago.com/2009-114/000-024



Item no.: 2009-114/000-012

WMB-Inline; for Smart Printer; 2000 pieces on roll; stretchable 4 - 4.2 mm; plain; snap-on type; orange

www.wago.com/2009-114/000-012



Item no.: 2009-114

WMB-Inline; for Smart Printer; 2000 pieces on roll; stretchable 4 - 4.2 mm; plain; snap-on type; white

www.wago.com/2009-114



Item no.: 793-4501/000-002

WMB marking card; as card; stretchable 4 - 4.2 mm; plain; snap-on type; yellow

www.wago.com/793-4501/000-002

Subject to changes. Please also observe the further product documentation!

WAGO GmbH & Co. KG

Hansastr. 27

32423 Minden

Phone: +49571 887-0 | Fax: +49571 887-169

Email: info.de@wago.com | Web: www.wago.com

Do you have any questions about our products?

We are always happy to take your call at +49 (571) 887-44222.



Item no.: 793-4501/000-006
WMB marking card; as card; stretchable 4 - 4.2 mm; plain; snap-on type; blue

www.wago.com/793-4501/000-006



Item no.: 793-4501
WMB marking card; as card; stretchable 4 - 4.2 mm; plain; snap-on type; white

www.wago.com/793-4501



Item no.: 793-4501/000-023
WMB marking card; as card; stretchable 4 - 4.2 mm; plain; snap-on type; green

www.wago.com/793-4501/000-023



Item no.: 793-4501/000-024
WMB marking card; as card; stretchable 4 - 4.2 mm; plain; snap-on type; violet

www.wago.com/793-4501/000-024



Item no.: 793-4501/000-005
WMB marking card; as card; stretchable 4 - 4.2 mm; plain; snap-on type; red

www.wago.com/793-4501/000-005



Item no.: 793-4501/000-007
WMB marking card; as card; stretchable 4 - 4.2 mm; plain; snap-on type; gray

www.wago.com/793-4501/000-007



Item no.: 793-4501/000-012
WMB marking card; as card; stretchable 4 - 4.2 mm; plain; snap-on type; orange

www.wago.com/793-4501/000-012



Item no.: 793-4501/000-017
WMB marking card; as card; stretchable 4 - 4.2 mm; plain; snap-on type; light green

www.wago.com/793-4501/000-017

Group marker carrier



Item no.: 209-142
Group marker carrier; gray

www.wago.com/209-142



Item no.: 209-141
Group marker carrier; gray

www.wago.com/209-141



Item no.: 209-140
Group marker carrier; gray

www.wago.com/209-140



Item no.: 249-105
Group marker carrier; gray

www.wago.com/249-105

Subject to changes. Please also observe the further product documentation!

Insulation stop

Insulation stop



Item no.: 279-470

Insulation stop; 0.08 - 0.2 mm² "s" (0.14 mm² "f-st"); 5 pieces/strip; white

www.wago.com/279-470



Item no.: 279-471

Insulation stop; 0.25 mm²; 5 pieces/strip; dark gray

www.wago.com/279-471

Mounting

Cover carrier

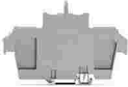

Item no.: 709-168

Cover carrier; Type 2; incl. fixing/retaining screws and knurled nut; suitable for 283 to 285 Series rail-mounted terminal blocks; suitable for 279 to 281 Series double- and triple-deck terminal blocks; suitable for 780 to 785, 775, 776 and 777 Series TOPJOB® rail-mounted terminal blocks; suitable for 280 Series sensor and actuator terminal blocks; suitable for 282 Series disconnect/test terminal blocks for transformer circuits; gray

www.wago.com/709-168

Cover



Item no.: 709-154

Cover; Type 2; suitable for cover carrier, type 2; 1 m long; transparent

www.wago.com/709-154

Mounting accessories



Item no.: 209-106

Mounting carrier; for isolated mounting on DIN 35 rails; gray

www.wago.com/209-106



Item no.: 249-116

Screwless end stop; 6 mm wide; for DIN-rail 35 x 15 and 35 x 7.5; gray

www.wago.com/249-116

Jumpers

Jumper



Item no.: 279-402

Jumper; insulated; gray

www.wago.com/279-402



Item no.: 279-409

Jumper; insulated; gray

www.wago.com/279-409



Item no.: 279-422

Jumper; insulated; yellow-green

www.wago.com/279-422



Item no.: 279-492

Jumper; 2-way; insulated; gray

www.wago.com/279-492



Item no.: 279-490

Jumper; 10-way; insulated; gray

www.wago.com/279-490



Item no.: 279-482

Jumper; 2-way; insulated; gray

www.wago.com/279-482



Item no.: 279-483

Subject to changes. Please also observe the further product documentation!

WAGO GmbH & Co. KG

Hansastr. 27

32423 Minden

Phone: +49571 887-0 | Fax: +49571 887-169









Email: info.de@wago.com | Web: www.wago.com

Do you have any questions about our products?

We are always happy to take your call at +49 (571) 887-44222.

Jumper; 3-way; insulated; gray

www.wago.com/279-483

| Ferrule | | |
|---|--|--|
| Ferrule | | |
|  | Item no.: 216-101 Ferrule; Sleeve for 0.5 mm ² / AWG 22; uninsulated; electro-tin plated; silver-colored | www.wago.com/216-101 |
|  | Item no.: 216-102 Ferrule; Sleeve for 0.75 mm ² / AWG 20; uninsulated; electro-tin plated; silver-colored | www.wago.com/216-102 |
|  | Item no.: 216-103 Ferrule; Sleeve for 1 mm ² / AWG 18; uninsulated; electro-tin plated | www.wago.com/216-103 |
|  | Item no.: 216-203 Ferrule; Sleeve for 1 mm ² / AWG 18; insulated; electro-tin plated; red | www.wago.com/216-203 |
|  | Item no.: 216-202 Ferrule; Sleeve for 0.75 mm ² / 18 AWG; insulated; electro-tin plated; gray | www.wago.com/216-202 |
|  | Item no.: 216-201 Ferrule; Sleeve for 0.5 mm ² / 20 AWG; insulated; electro-tin plated; white | www.wago.com/216-201 |
|  | Item no.: 216-301 Ferrule; Sleeve for 0.25 mm ² / AWG 24; insulated; electro-tin plated; yellow | www.wago.com/216-301 |
|  | Item no.: 216-302 Ferrule; Sleeve for 0.34 mm ² / 22 AWG; insulated; electro-tin plated; light turquoise | www.wago.com/216-302 |

Downloads

Documentation

Bid Text

| | | | |
|------------------------|-------------|----------------|----------|
| 279-508 X81 - Datei | 2019 Feb 19 | xml 3.4 kB | Download |
| 279-508 doc - Datei | 2017 Feb 28 | doc 25.1 kB | Download |

Additional Information

| | | |
|---|---------------|----------|
| Technical Section Technical explanations | pdf 2.2 MB | Download |
|---|---------------|----------|

CAD/CAE-Data

CAD data

Subject to changes. Please also observe the further product documentation!

2D/3D Models 279-508

[URL](#)

[Download](#)

CAE data

EPLAN Data Portal 279-508

[URL](#)

[Download](#)

WSCAD Universe 279-508

[URL](#)

[Download](#)

ZUKEN Portal 279-508

[URL](#)

[Download](#)

Environmental Product Compliance

Compliance Search

Environmental Product Compliance 279-508

[URL](#)

[Download](#)

Double-deck terminal block; 4-conductor through terminal block; L; suitable for Ex i applications; internal commoning; conductor entry with violet marking; for DIN-rail 35 x 15 and 35 x 7.5; 1.5 mm²; 1,50 mm²; gray

Installation Notes

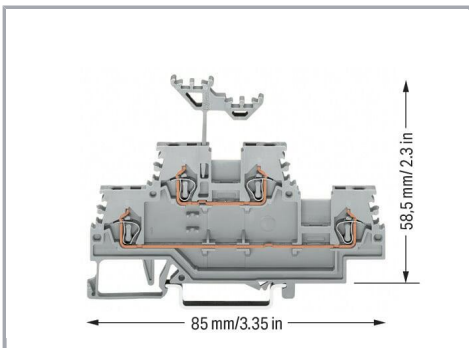

Double-deck marker carrier

(height including marker carrier)

Product family

Classic

EPSITRON® CLASSIC POWER: The Robust Power Supply – with Integrated TopBoost (Optional)

[Show all products from the family](#)

Subject to changes. Please also observe the further product documentation!

WAGO GmbH & Co. KG

Hansastr. 27

32423 Minden

Phone: +49571 887-0 | Fax: +49571 887-169

Email: info.de@wago.com | Web: www.wago.com

Do you have any questions about our products?

We are always happy to take your call at +49 (571) 887-44222.