

SPECIFICATIONS **CDSA23W2W**
OUTLINES DIMENSIONS

- Notes:
1. All Dimensions are in millimeters (inches).
 2. Tolerance is $\pm 0.25\text{mm}$ (0.01") unless otherwise noted.
 3. Specifications are subject to change without notice.

Part Number	Chip Material	Color of Emission	Lens Type	Description
CDSA23W2W	InGaN	White	White Segment	Common Anode

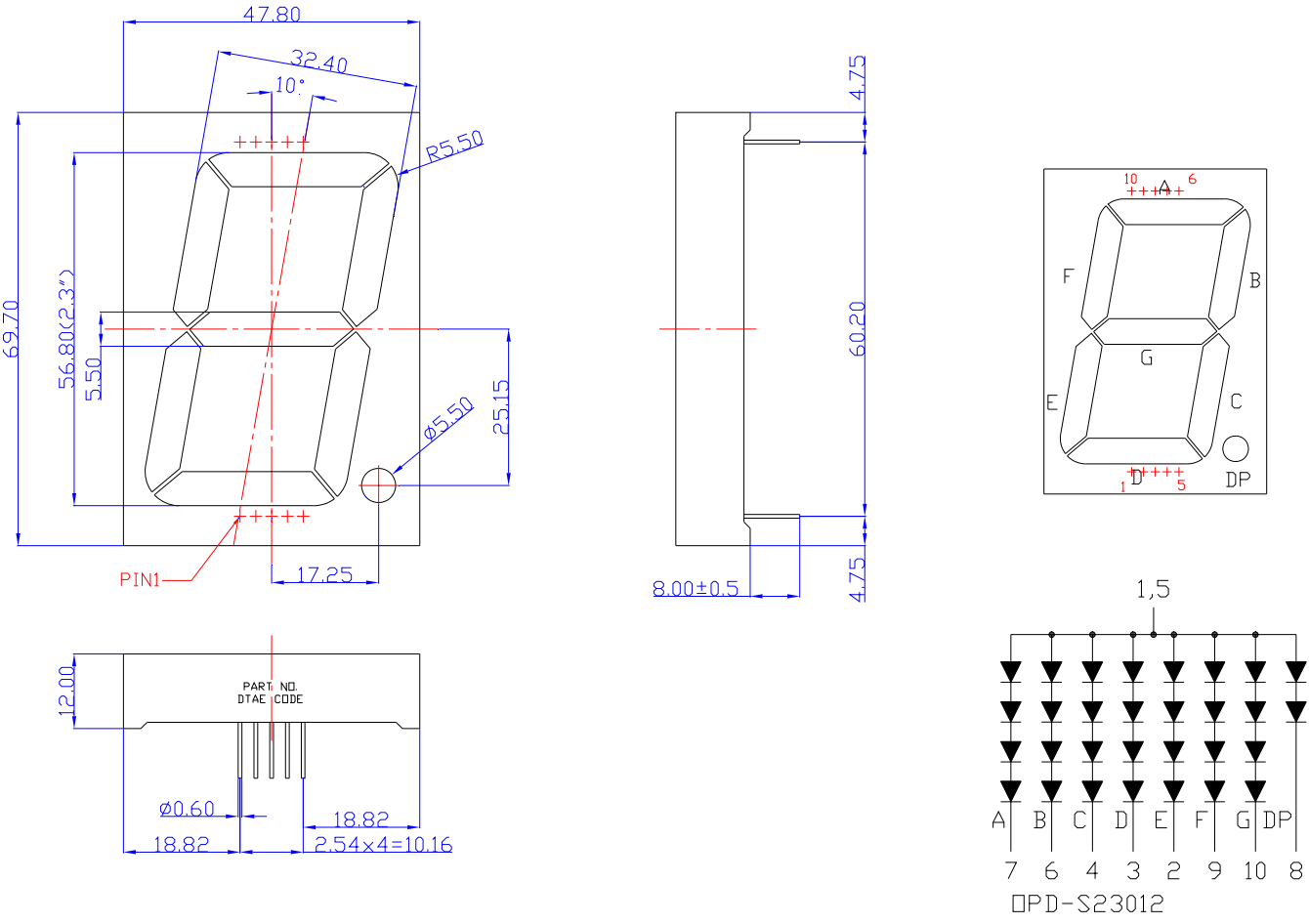

ChromeLED Corp. reserves the right to make changes at any time in order to supply the best product possible. The most current version of this document will always be available at: www.chromeled.com

ABSOLUTE MAXIMUM RATINGS
(TA=25°C)

Parameter	Symbol	Max Rating	Unit
Power Dissipation	P_D	78	mW
Pulse Forward Current	I_{FP}	80	mA
Continuous Forward Current	I_F	20	mA
Reverse Voltage Segment	V_R	5	V
Operating Temperature Range	T_{OPR}	-30~+80	°C
Storage Temperature Range	T_{STG}	-40~+85	°C
I_{FP} = Pulse Width \leq 10 ms, Duty Ratio \leq 1/10. Soldering Condition: 260 °C/ 5sec			

OPTICAL-ELECTRICAL CHARACTERISTICS
(TA=25°C)

Parameter	Symbol	Test Condition	Value			Unit
			Min	Typ	Max	
Luminous Intensity	I_V	$I_F = 20\text{mA}$	112	160	-	mcd
Forward Voltage	V_F	$I_F = 20\text{mA}$	-	11.6	-	V
Reverse Leakage Current	I_R	$V_R = 20\text{V}$	-	-	10	μA
Chromaticity Coordinates	X	$I_F = 5\text{mA}$	-	0.29	-	-
Chromaticity Coordinates	λ_D	$I_F = 5\text{mA}$	-	0.28	-	-
Spectral Radiation Bandwidth	$\Delta\lambda$	$I_F = 5\text{mA}$	-	30	-	nm



ChromeLED Corp. reserves the right to make changes at any time in order to supply the best product possible. The most current version of this document will always be available at: www.chromeled.com

OPTICAL CHARACTERISTIC CURVES

Typical Electro-optical Characteristic Curves (25 °C Free Air Temperature Unless Otherwise Specified)

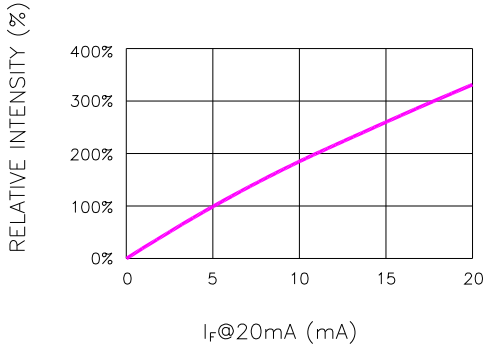

Fig.1 RELATIVE INTENSITY VS. FORWARD CURRENT

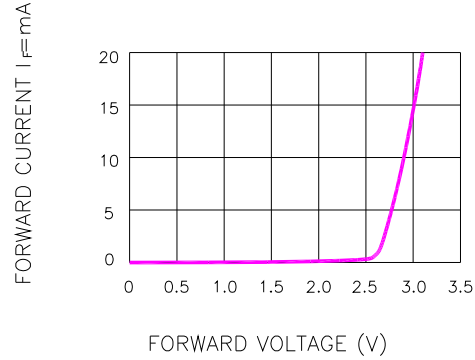

Fig.2 FORWARD CURRENT VS. FORWARD VOLTAGE

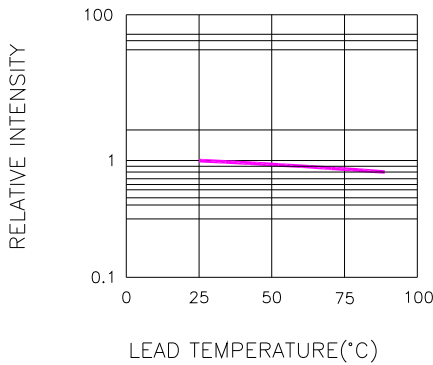

Fig.3 RELATIVE INTENSITY VS. LEAD TEMPERATURE
(PULSED 20 mA; 300us PULSE, 10ms PERIOD)

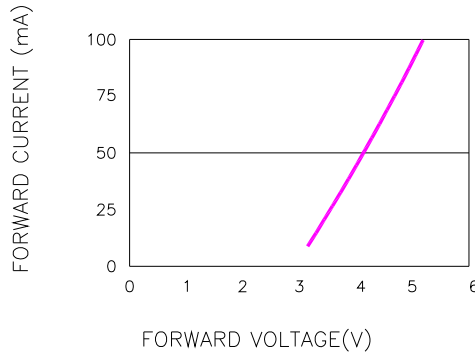

Fig.4 PEAK FORWARD VOLTAGE VS. FORWARD
(100us TEST PULSE, 1% DUTY CYCLE)

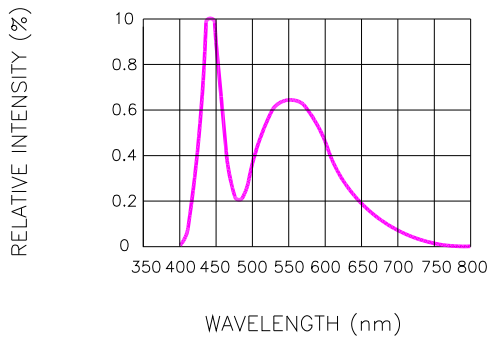

Fig.4 RELATIVE INTENSITY VS. WAVELENGTH

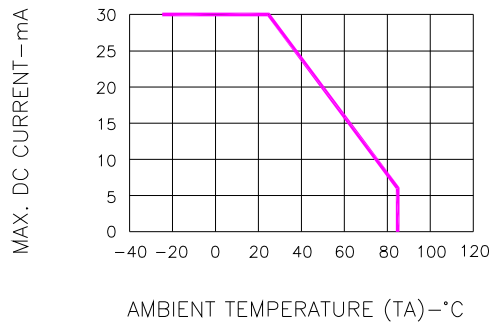

Fig.7 MAX. ALLOWABLE DC CURRENT VS. AMBIENT TEMPERATURE



ChromeLED Corp. reserves the right to make changes at any time in order to supply the best product possible. The most current version of this document will always be available at: www.chromeled.com

SOLDERING CONDITIONS – DISPLAY TYPE LED

● RECOMMEND SOLDERING PROFILE

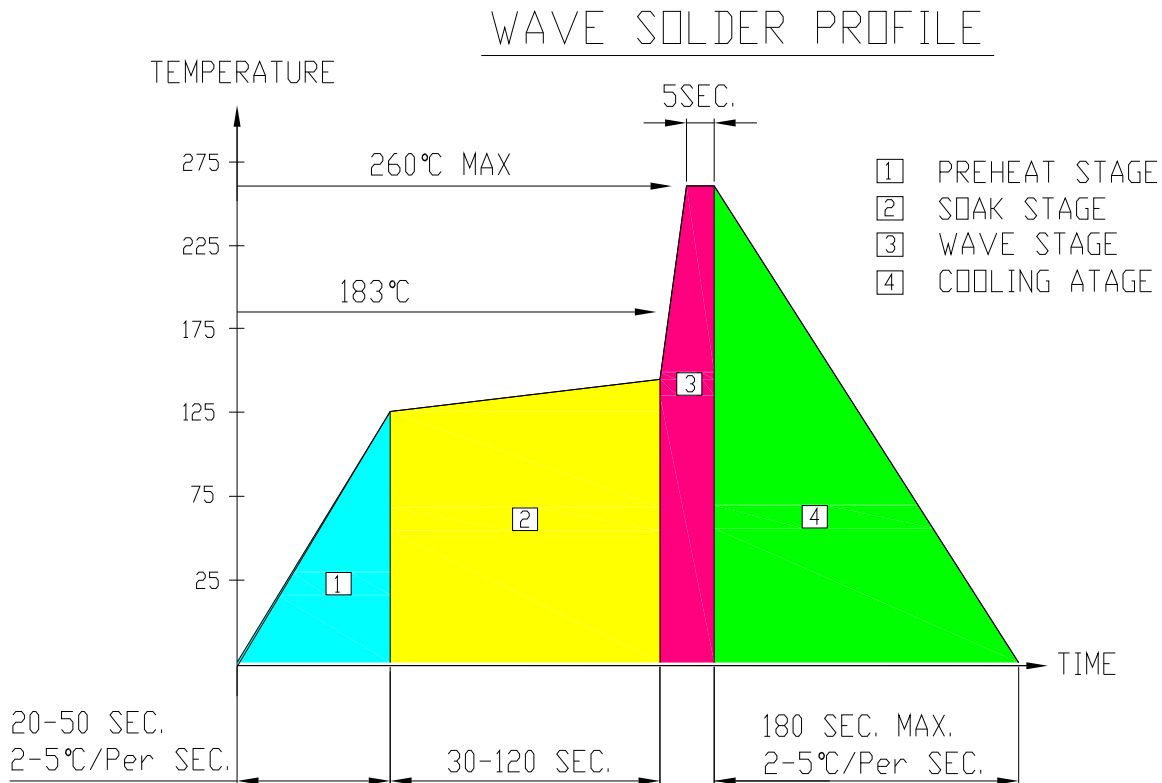

● SOLDERING IRON

Basic spec is ≤ 4 sec when 260°C. If temperature is higher, time should be shorter (+10°C → 1 sec). Power dissipation of Iron should be smaller than 15W, and temperature should be controllable. Surface temperature of the device should be under 230°C.

● REWORK

Customer must finish rework within ≤ 4 sec under 245°C.



ChromeLED Corp. reserves the right to make changes at any time in order to supply the best product possible. The most current version of this document will always be available at: www.chromeled.com