

# 1MS/1M1

## 1M-Series

### MINIATURE ROCKERS & PADDLES

The 1M family of miniature rocker & paddle switches is composed of two switch series; the **1M1-Series** miniature rocker and paddle switch, and the **1MS-Series** sealed miniature rocker and paddle switch. Both products feature PC mounting and offer a variety of ratings, circuits, contact materials, terminal platings, rocker and paddle actuator styles and colors.

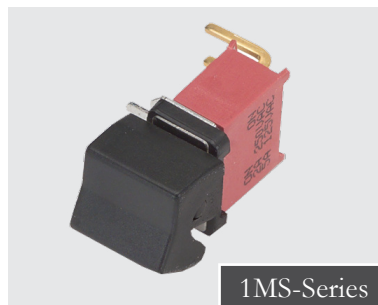

#### Product Highlights:

- IP67 Sealing
- 9 Circuit Options
- Over 20 Termination Styles
- UL, CSA & cUL Approvals

#### Typical Applications:

- Instrumentation
- Test Equipment
- Telecommunications
- Networking
- Handheld Appliance

#### Resources:

[Configure a Complete Part](#)

[Download CAD & Sales Drawing >](#)



**Carling Technologies®**

Innovative Designs. Powerful Solutions.

**Carling Technologies, Inc.**  
60 Johnson Avenue, Plainville, CT 06062  
Email: [sales@carlingtech.com](mailto:sales@carlingtech.com)  
Application Support: [team2@carlingtech.com](mailto:team2@carlingtech.com)  
Phone: 860.793.9281 Fax: 860.793.9231

[www.carlingtech.com](http://www.carlingtech.com)



**1MS-Series**  
**Sealed**  
 Miniature Rocker  
 & Rocker Switch



**1M1-Series**  
 Miniature Rocker  
 & Rocker Switch

### Electrical

Contact Rating	refer to ordering scheme
Electrical Life	<i>1MS-Series:</i> 30,000 make & break cycles @ full load <i>1M1-Series:</i> 50,000 make & break cycles @ full load
Contact Resistance	10 mΩ max. initial @ 2-4 VDC 100mA for both silver & gold plated contacts
Insulation Resistance	1000 MΩ min.
Dielectric Strength	1500 Volts RMS @ sea level

### Physical

Operating Temperature	-30°C to +85°C
Index of Protection	1MS-Series: IP67
Solder Heat Resistance	MIL-STD-202, Method 210
Actuator Travel	25°

### Material

Case	<i>1MS-Series:</i> Glass filled nylon 6/6, flame retardant, heat stabilized (UL 94V-0) <i>1M1-Series:</i> Dially phthalate (DAP) (UL 94V-0)
Rocker/Paddle	<i>1MS-Series:</i> Nylon, black standard, internal o-ring sealed <i>1M1-Series:</i> Nylon (UL 94V-0)
Bushing	<i>1MS-Series:</i> Glass filled nylon 6/6, flame retardant, heat stabilized (UL 94V-0) <i>1M1-Series:</i> Brass, nickel plated
Housing	<i>1MS-Series:</i> Spring Steel <i>1M1-Series:</i> Stainless Steel
Actuator Pivot & Mounting Bracket	<i>1MS-Series:</i> Nylon (UL 94V-0) <i>1M1-Series:</i> Stainless Steel
Actuator Pivot Retainer	<i>1MS-Series:</i> Stainless Steel
Switch Support	Brass, tin plated
Terminal Seal	Epoxy

\*Manufacturer reserves the right to change product specification without prior notice.

**1MS - SP 1 - R6 / 2 M6 G E**

1 Series      2 Poles      3 Circuit      4 Actuator Style      5 Actuator Color      6 Termination      7 Contacts      8 Seal

**1 SERIES**  
**1MS** Sealed Miniature Rocker Switch

**2 POLES**  
**SP** Single pole - uses terminals 1, 2 & 3  
**DP** Double pole uses terminals 1,2, 3, 4, 5 & 6  
**3P** Three pole uses terminals 1,2, 3, 4, 5, 6, 7, 8 & 9

**3 CIRCUIT**  
 ( ) - momentary  
**Position:**

1	2	3
2-3, 5-6, 8-9	Connected Terminals	2-1, 5-4, 8-7
1	ON	NONE ON
2	ON	NONE (ON)
3	ON	OFF ON
4	(ON)	OFF (ON)
5	ON	OFF (ON)
6*	ON	ON ON
7*	(ON)	ON (ON)
8*	ON	ON (ON)
9*	OFF	ON (ON)

\*Center Position Connects 2-3, 5-4, 8-9

**4 ACTUATOR STYLE**

<b>R1</b> Standard Rocker	<b>R4</b> Large Paddle
<b>R2</b> Standard Paddle	<b>R5</b> Large Rocker
<b>R3</b> Medium Rocker	<b>R6</b> Small Rocker
	<b>R7</b> Medium Paddle

**5 ACTUATOR COLOR**

<b>1</b> White	<b>2</b> Black	<b>3</b> Red
----------------	----------------	--------------





Black is standard. Other colors available, consult factory.

**6 TERMINATION**

<b>M1</b> Solder Lug	<b>VS2</b> PC Mount, U bracket
<b>M2</b> PCB	<b>VS3</b> PC Mount, U bracket
<b>M3</b> Quick Connect	<b>VS4</b> PC Mount, U bracket
<b>M51</b> Wire Wrap	<b>VS5</b> PC Mount, U bracket
<b>M52</b> Wire Wrap	<b>VS21</b> Snap-In, U bracket
<b>M53</b> Wire Wrap	<b>VS31</b> Snap-In, U bracket
<b>M54</b> Wire Wrap	<b>VS41</b> Snap-In, U bracket
<b>M6</b> PC Mount, 90° horizontal	<b>VS51</b> Snap-In, U bracket
<b>M7</b> PC Mount, 90° vertical	<b>U2</b> Vertical Mount, 3-Pole
	<b>U4</b> Snap-In, U bracket, 3-Pole

See page 16-18 for dimensional specifications.

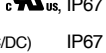
**7 CONTACTS / TERMINALS**

	Contact Material	Terminal Plating	Rating	Approvals
<b>G</b>	silver <sup>1</sup>	gold over silver	5A 125VAC or 28VDC, 2A 250VAC	
<b>K</b>	gold 2,5	tin 4	0.4VA max 20V max (AC/DC)	
<b>P</b>	silver 1,6	tin 4	5A 125VAC or 28VDC, 2A 250VAC	
<b>R</b>	gold 2	gold 3	0.4VA max 20V max (AC/DC)	

**8 EPOXY SEAL**

<b>E</b> Epoxy Seal	<b>0</b>	without Epoxy Seal
---------------------	----------	--------------------

Notes:  
 Tin option not available with M1 and M3 terminals.  
 1 Movable contact and terminal platings: silver over copper alloy  
 2 Movable contact platings: gold over nickel over copper alloy  
 3 Terminal platings: gold over nickel over copper alloy  
 4 Terminal platings: tin over copper alloy  
 5 Terminal contact platings: gold over nickel alloy  
 6 Terminal contact platings: silver over nickel alloy

**1M1 - SP 1 - R8 / 2 - M6 Q E**

1 Series      2 Poles      3 Circuit      4 Actuator Style      5 Actuator Color      6 Frame Color      7 Termination      8 Contacts      9 Seal

**1 SERIES**  
**1M1** Miniature Rocker Switch

**2 POLES**  
**SP** Single pole - uses terminals 1, 2 & 3  
**DP** Double pole uses terminals 1,2, 3, 4, 5 & 6  
**3P** Three pole uses terminals 1,2, 3, 4, 5, 6, 7, 8 & 9  
**4P** Four pole uses terminals 1,2, 3, 4, 5, 6, 7, 8, 9, 10, 11, 12

**3 CIRCUIT**  
 ( ) - momentary  
**Position:**

1	2	3
2-3, 5-6, 8-9, 11-12	Connected Terminals	2-1, 5-4, 8-7, 11-10
1	ON	NONE ON
2	ON	NONE (ON)
3	ON	OFF ON
4	(ON)	OFF (ON)
5	ON	OFF (ON)
6 <sup>1</sup>	ON	ON ON
7 <sup>1</sup>	(ON)	ON (ON)
8 <sup>1</sup>	ON	ON (ON)
9 <sup>2</sup>	NONE	ON (ON)

**4 ACTUATOR STYLE**

<b>R1</b> Standard Rocker	<b>R5</b> Large rocker
<b>R2</b> Standard Paddle	<b>R6</b> Rocker & frame
<b>R3</b> Medium Rocker	<b>R7</b> Paddle & frame
<b>R4</b> Large Paddle	<b>R8</b> Rocker without frame
	<b>R9</b> Paddle without frame

**5 ACTUATOR COLOR / 6 FRAME COLOR**

<b>0</b> No Frame*	<b>2</b> Black
<b>1</b> White	<b>3</b> Red





Black is standard. Other colors available, consult factory.  
 \*Actuator style R8 or R9 only.

**7 TERMINATION**

<b>M1</b> Solder Lug	<b>VS3</b> PC Mount, U bracket
<b>M2</b> PCB	<b>VS4</b> PC Mount, U bracket
<b>M3</b> Quick Connect	<b>VS5</b> PC Mount, U bracket
<b>M51</b> Wire Wrap	<b>M61</b> Snap-In, U bracket, 90° horizontal
<b>M52</b> Wire Wrap	<b>M71</b> Snap-In, U bracket, 90° vertical
<b>M53</b> Wire Wrap	<b>VS21</b> Snap-In, U bracket
<b>M54</b> Wire Wrap	<b>VS31</b> Snap-In, U bracket
<b>M6</b> PC Mount, 90° horizontal	<b>VS41</b> Snap-In, U bracket
<b>M7</b> PC Mount, 90° vertical	<b>VS51</b> Snap-In, U bracket
<b>VS2</b> PC Mount, U bracket	<b>U4</b> Snap-In, U bracket, 3-Pole

See page 21-23 for dimensional specifications.

**8 CONTACTS / TERMINALS**

	Contact Material	Terminal Plating	Rating	Approvals
<b>G</b>	silver <sup>3</sup>	gold over silver	5A 125VAC or 28VDC, 2A 250VAC	
<b>K</b>	gold 4,7	tin 6	0.4VA max 20V max (AC/DC)	
<b>P</b>	silver 3,8	tin 6	5A 125VAC or 28VDC, 2A 250VAC	
<b>Q</b>	silver <sup>3</sup>	silver <sup>3</sup>	5A 125VAC or 28VDC, 2A 250VAC	
<b>R</b>	gold 4	gold 5	0.4VA max 20V max (AC/DC)	

**9 EPOXY SEAL**

<b>E</b> Epoxy Seal	<b>0</b>	without Epoxy Seal
---------------------	----------	--------------------

Notes:  
 Tin option not available with M1 and M3 terminals.  
 1 Double-Pole and Four-Pole only. Center position connects 2-3, 5-4, 8-9, 11-10  
 2 Double-Pole only  
 3 Movable contact and terminal platings: silver over copper alloy  
 4 Movable contact platings: gold over nickel over copper alloy  
 5 Terminal platings: gold over nickel over copper alloy  
 6 Terminal platings: tin over copper alloy  
 7 Terminal contact platings: gold over nickel alloy  
 8 Terminal contact platings: silver over nickel alloy

# 1MS-Series Dimensional Specifications: in. [mm]

## Single Pole

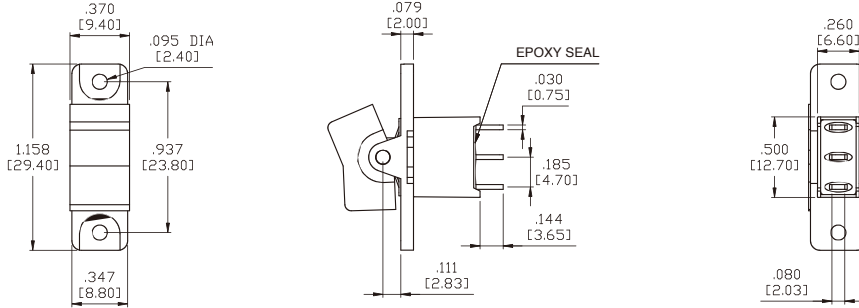

## Double Pole

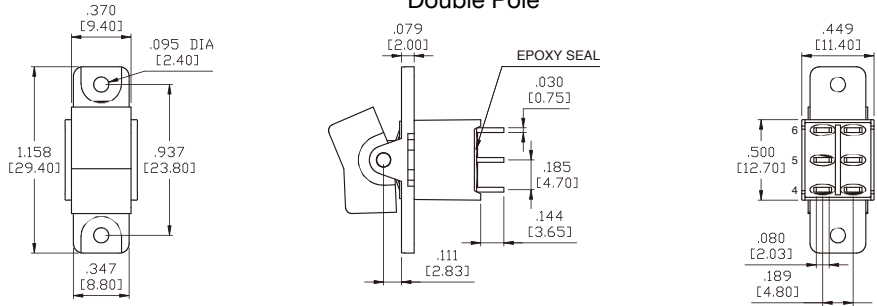

## Three Pole

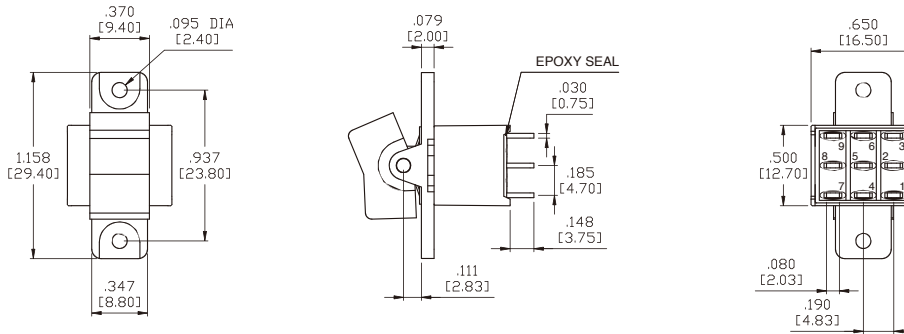

## Actuator Options for Panel Rear Mount

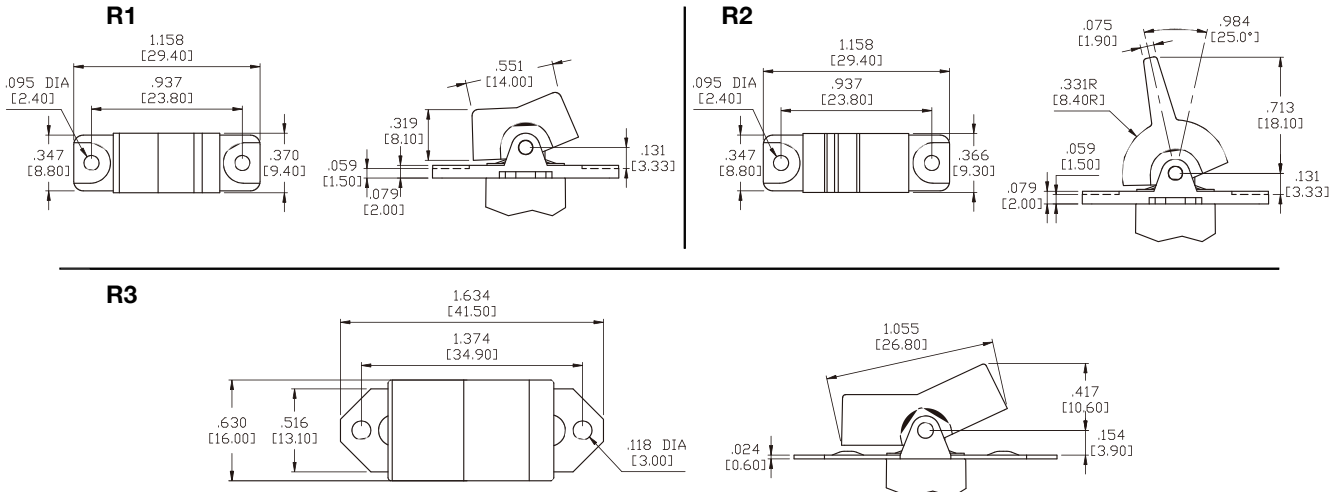

## 1MS-Series Dimensional Specifications: in. [mm]

### Actuator Options for Panel Rear Mount

**R4**

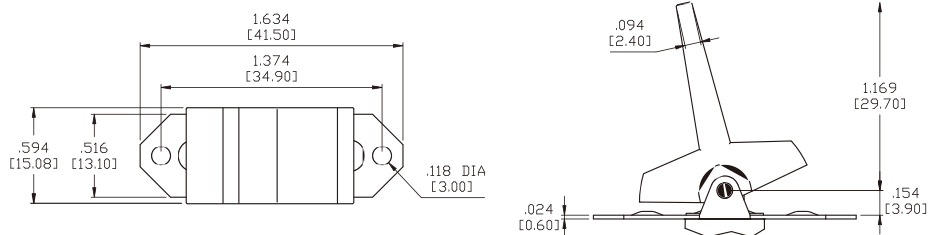

**R5**

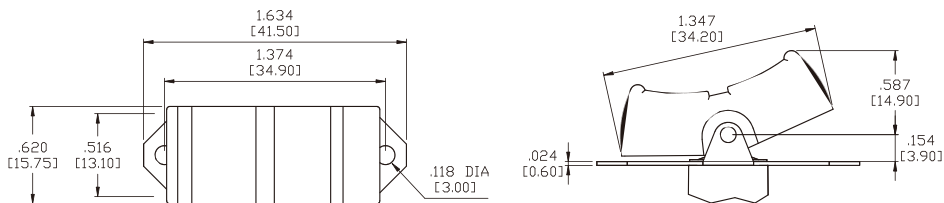

**R6**

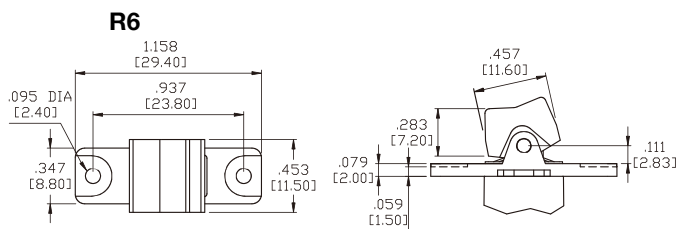

**R7**

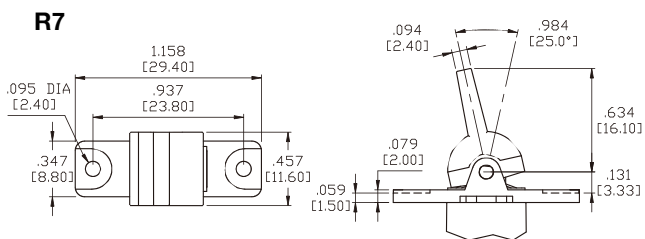

### Actuator Options for PC Mount

**R1**

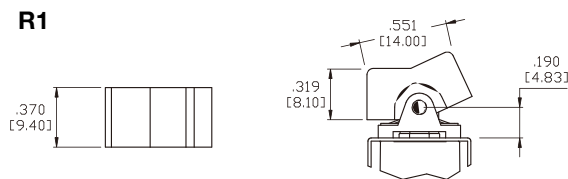

**R2**

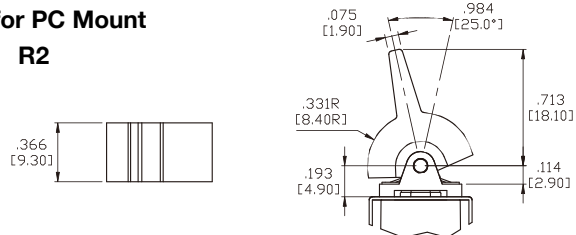

**R3**

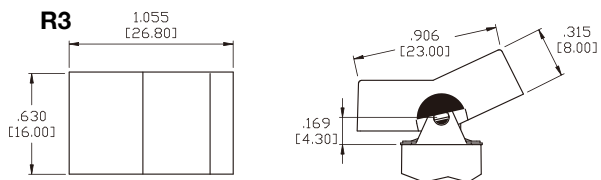

**R4**

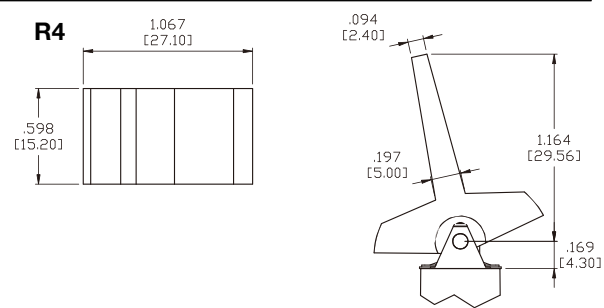

**R5**

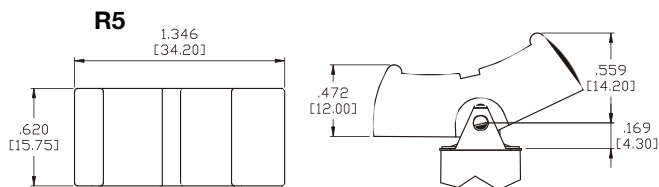

**R6**

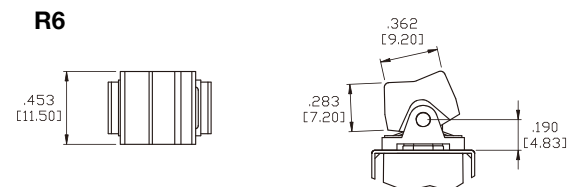

# 1MS-Series Dimensional Specifications: in. [mm]

## Actuator Options for PC Mount

R7

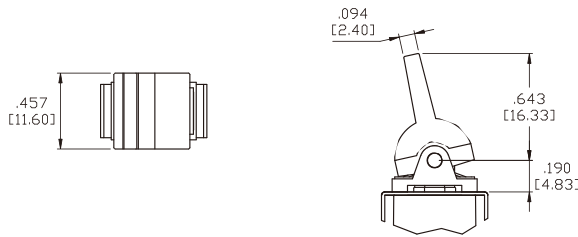

## Termination Options

### M1 Standard Solder Lug

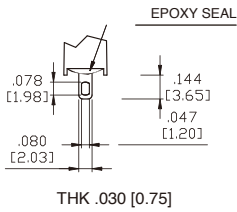

### M2 PC Thru-Hole

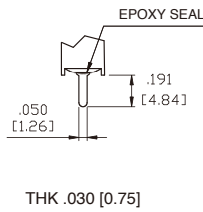

### M3 Quick Connect

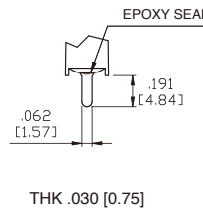

### M5 Wire Wrap

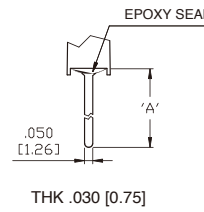

OPTION CODE	DIM. 'A'
M5-1	.711 [18.05]
M5-2	.924 [23.48]
M5-3	.386 [9.80]
M5-4	1.022 [25.97]

### M6 Single Pole

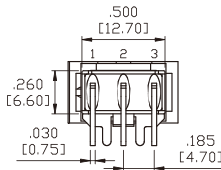
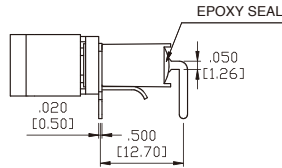
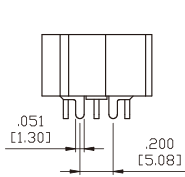

### P.C.MOUNTING

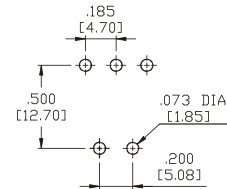

### M6 Double Pole

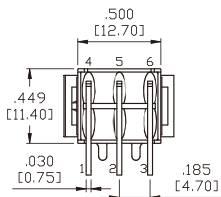
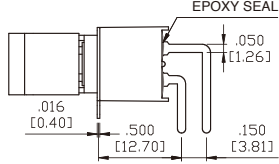
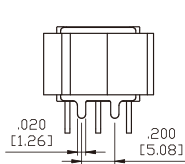

### P.C.MOUNTING

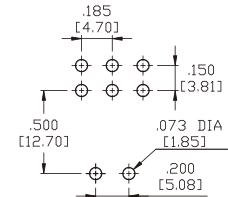

### M6 Three Pole

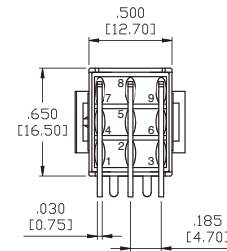
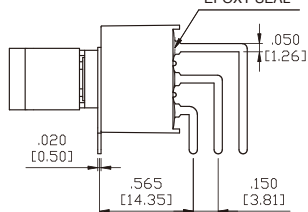
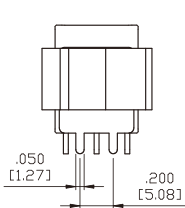

### P.C.MOUNTING

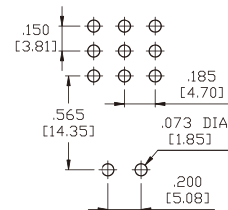

### M7 Single Pole

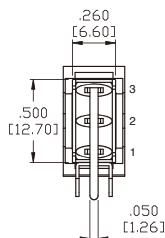
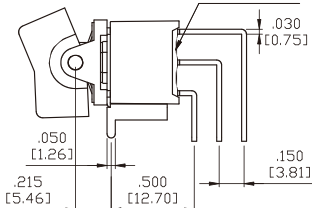
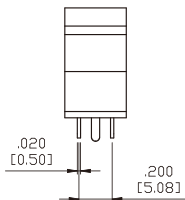

### P.C.MOUNTING

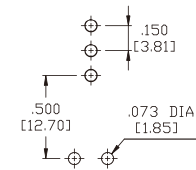

# 1MS-Series Dimensional Specifications: in. [mm]

## Termination Options

### M7 Double Pole

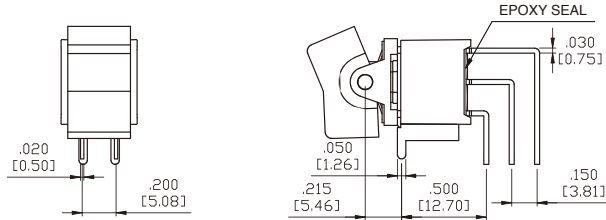

### P.C.MOUNTING

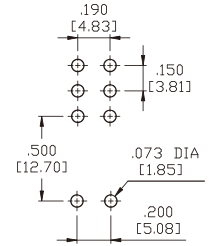

### M7 Three Pole

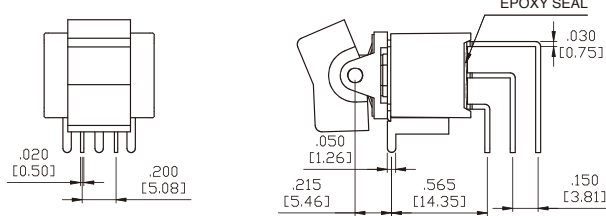

### P.C.MOUNTING

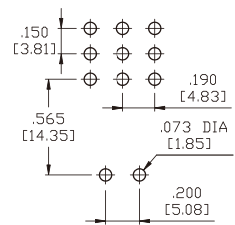

### VS2-VS3 Single Pole

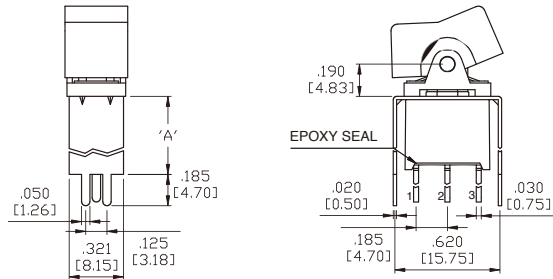

OPTION CODE	DIM.'A'
<b>VS2</b>	.461 [11.70]
<b>VS3</b>	.630 [16.00]

### P.C.MOUNTING

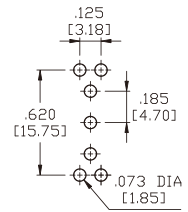

### VS2-VS3 Double Pole

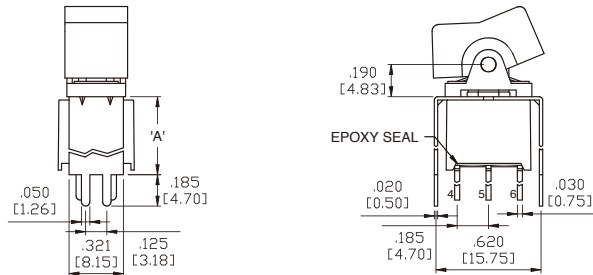

OPTION CODE	DIM.'A'
<b>VS2</b>	.461 [11.70]
<b>VS3</b>	.630 [16.00]

### P.C.MOUNTING

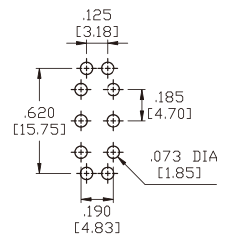

### U2-VS3 Three Pole

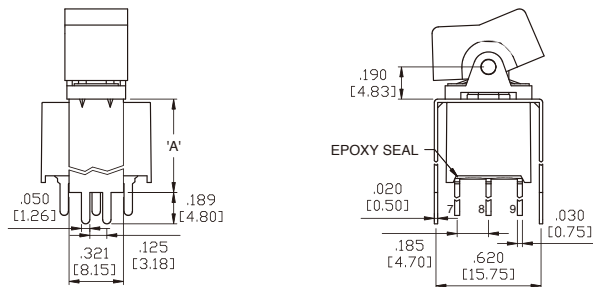

OPTION CODE	DIM.'A'
<b>U2</b>	.551 [14.00]
<b>VS3</b>	.630 [16.00]

### P.C.MOUNTING

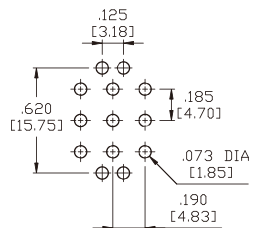

# 1MS-Series Dimensional Specifications: in. [mm]

## Termination Options

### VS4-VS5 Single Pole

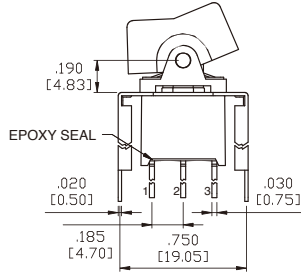
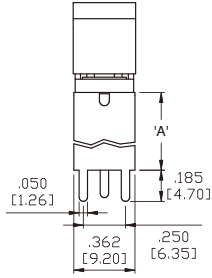

OPTION CODE	DIM.'A'
<b>VS4</b>	.461 [11.70]
<b>VS5</b>	.630 [16.00]

### P.C.MOUNTING

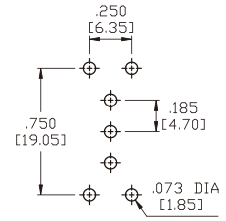

### VS4-VS5 Double Pole

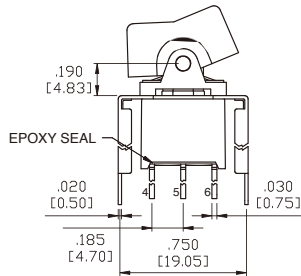
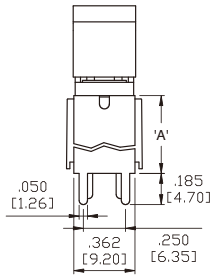

OPTION CODE	DIM.'A'
<b>VS4</b>	.461 [11.70]
<b>VS5</b>	.630 [16.00]

### P.C.MOUNTING

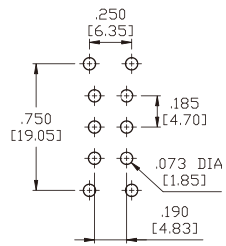

### U4-VS5 Three Pole

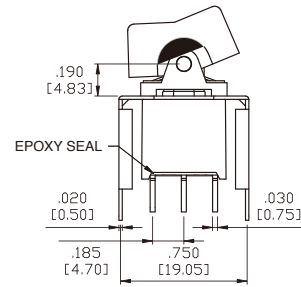
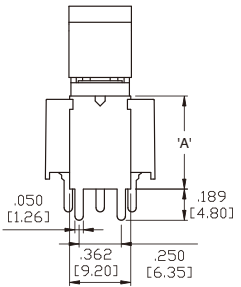

OPTION CODE	DIM.'A'
<b>U4</b>	.551 [14.00]
<b>VS5</b>	.630 [16.00]

### P.C.MOUNTING

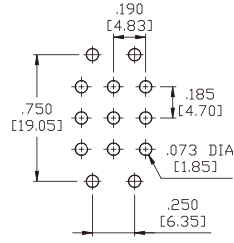

## Snap-In Termination Options

### M61

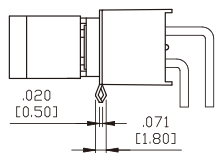
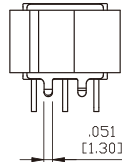
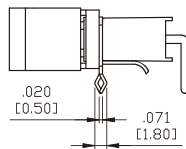
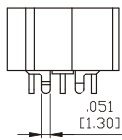

### VS21, VS31

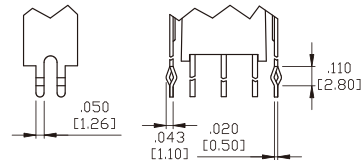

### VS41, VS51

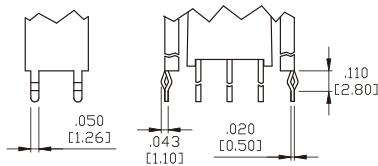

\* PC Mounting for M61, M71, VS21, VS31, VS41, VS51 refer to M6, M7, VS2, VS3, VS4, VS5 respectively.



## 1M1-Series Dimensional Specifications: in. [mm]

### Single Pole

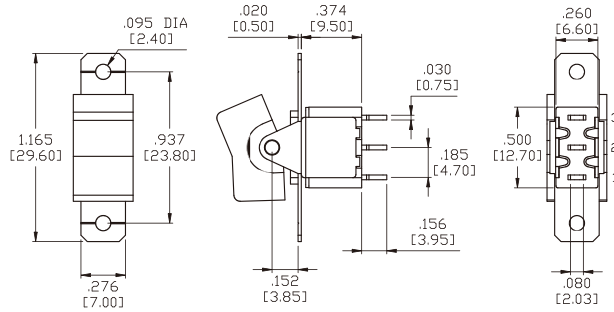

### Double Pole

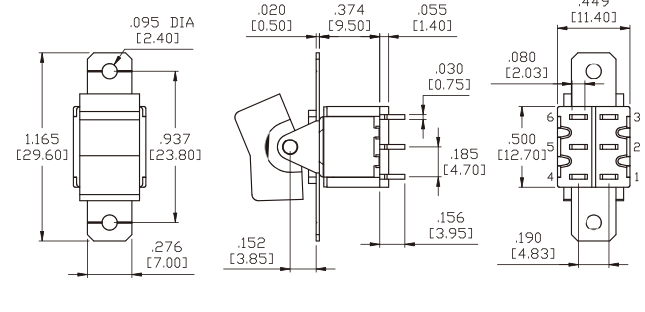

### Three Pole

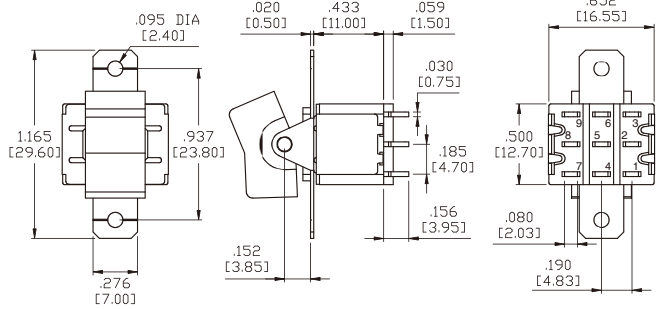

### Four Pole

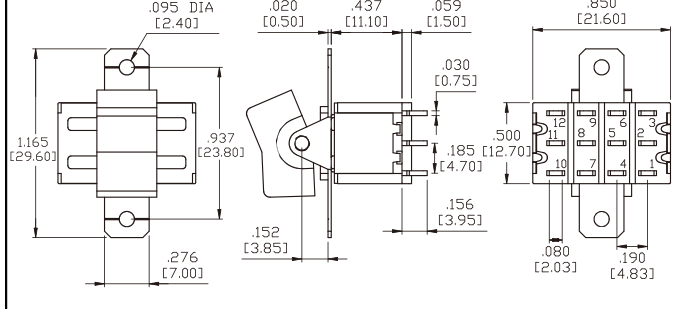

### Actuator Options for Panel Rear Mount

#### R1

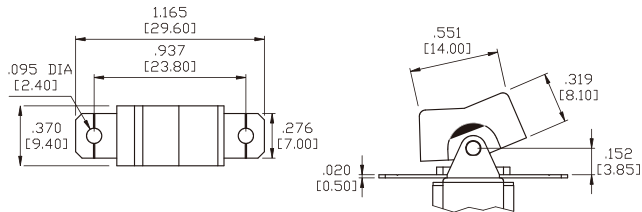

#### R2

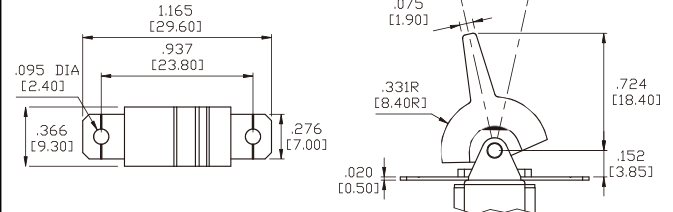

#### R3

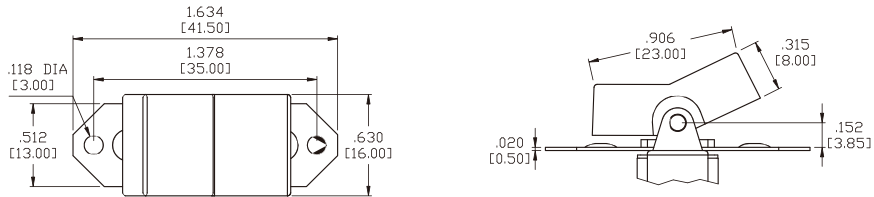

#### R4

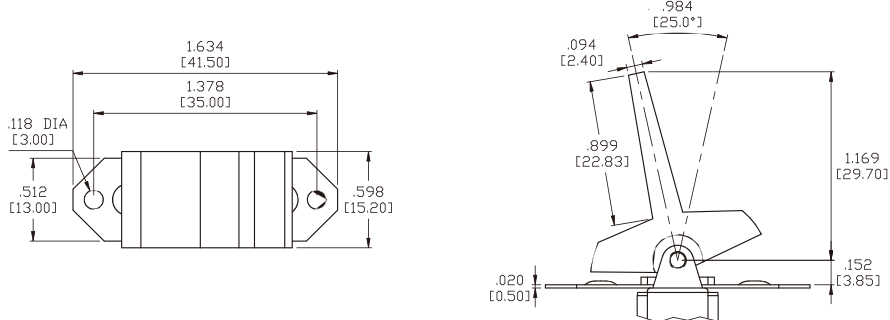

## 1M1-Series Dimensional Specifications: in. [mm]

### Actuator Options for Panel Rear Mount

**R5**

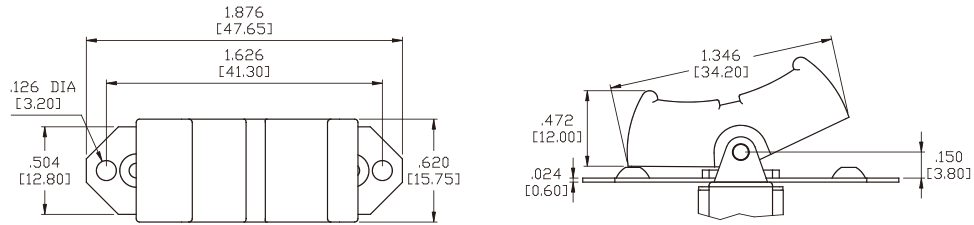

### Actuator Options for Snap-In Mount

**R6**

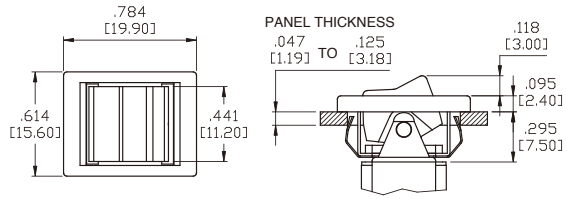

**R6 WITHOUT FRAME**

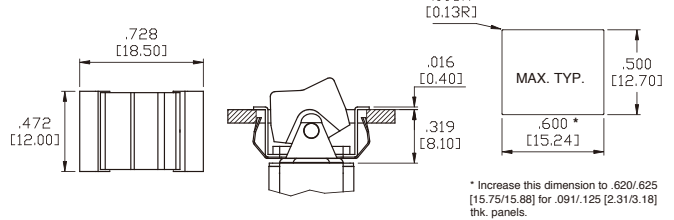

**R7**

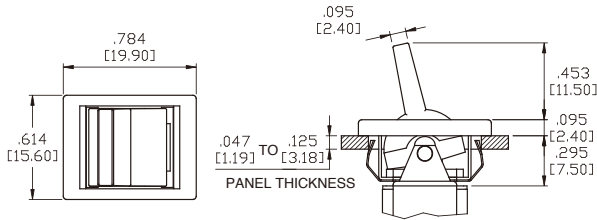

**R7 WITHOUT FRAME**

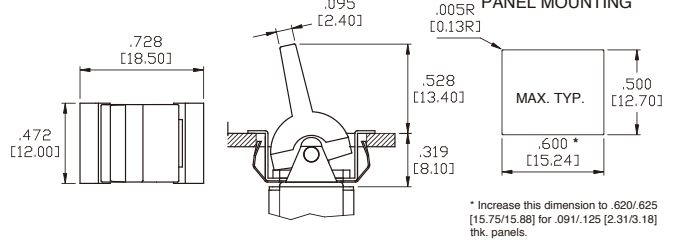

### Actuator Options for PC Mount

**R1**

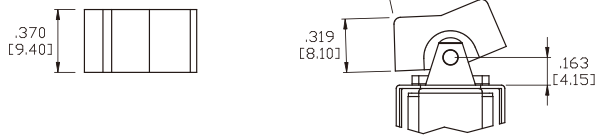

**R2**

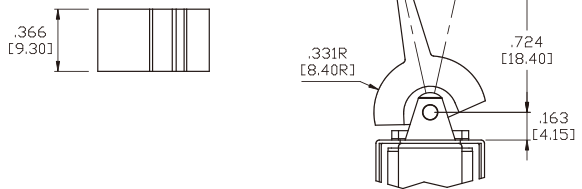

**R3**

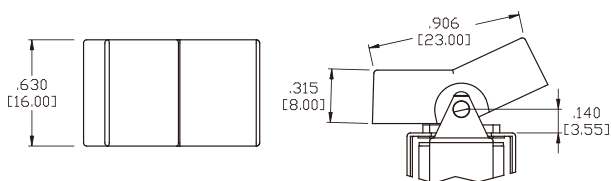

**R4**

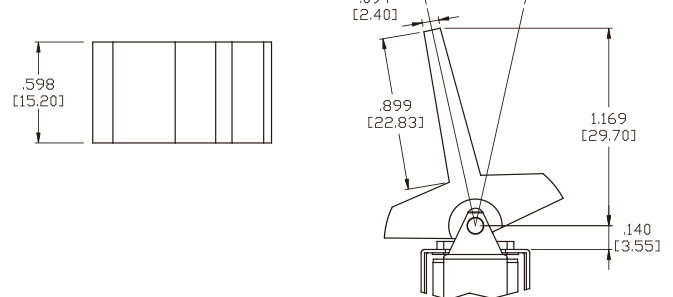

## 1M1-Series Dimensional Specifications: in. [mm]

### Actuator Options for PC Mount

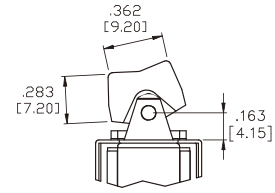
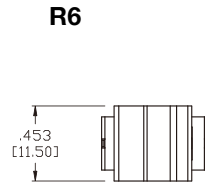
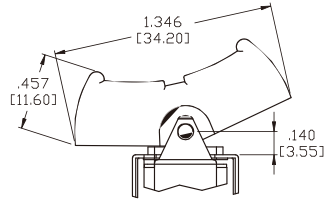
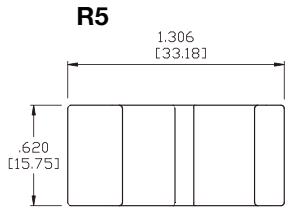

**R7**

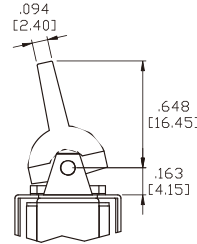

### Termination Options

**M1 Standard Solder Lug**

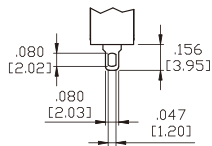

THK .030 [0.75]

**M2 PC Thru-Hole**

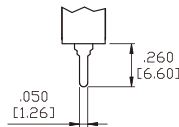

THK .030 [0.75]

**M3 Quick Connect**

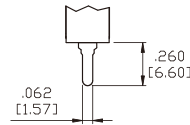

THK .030 [0.75]

**M5 Wire Wrap**

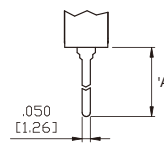

THK .030 [0.75]

OPTION CODE	DIM. 'A'
<b>M5-1</b>	.750 [19.05]
<b>M5-2</b>	.964 [24.48]
<b>M5-3</b>	.425 [10.80]
<b>M5-4</b>	1.062 [26.97]

**M6 Single Pole**

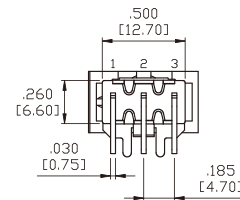
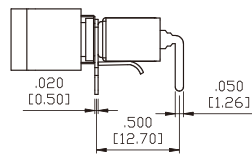
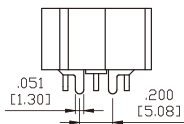

**P.C.MOUNTING**

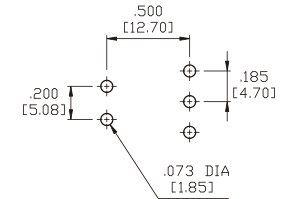

**M6 Double Pole**

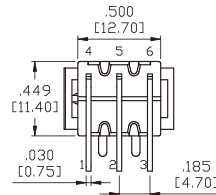
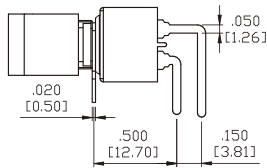
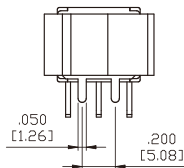

**P.C.MOUNTING**

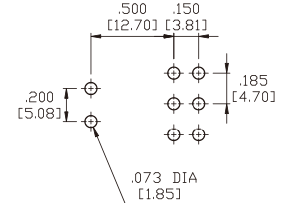

**M7 Single Pole**

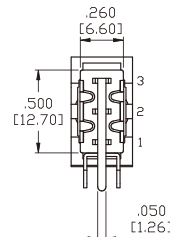
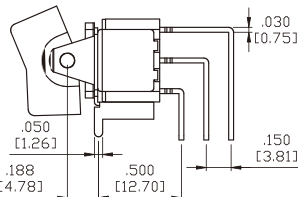
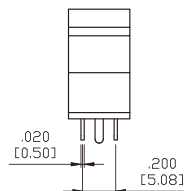

**P.C.MOUNTING**

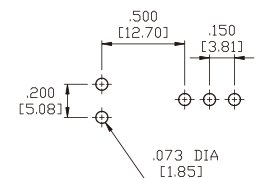

# 1M1-Series Dimensional Specifications: in. [mm]

## Termination Options

### M7 Double Pole

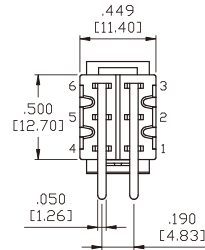
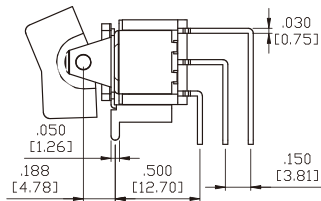
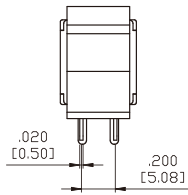

### P.C.MOUNTING

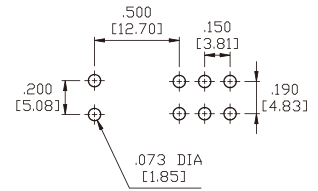

### M7 Three Pole

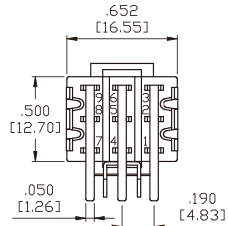
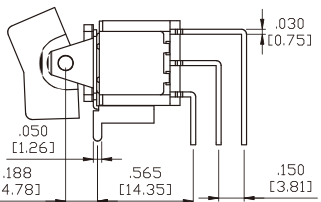
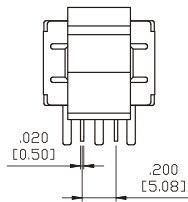

### P.C.MOUNTING

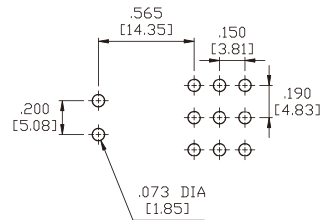

### M7 Four Pole

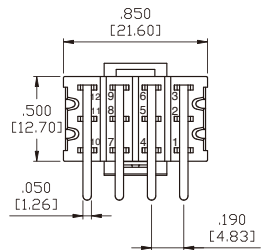
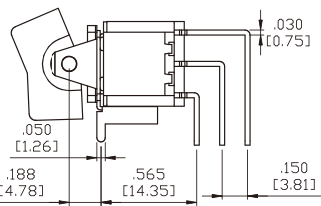
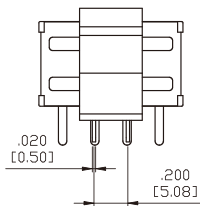

### P.C.MOUNTING

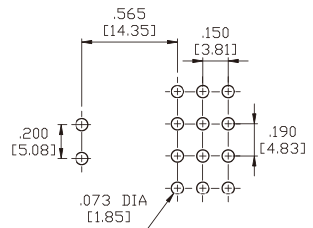

### VS2-VS3 Single Pole

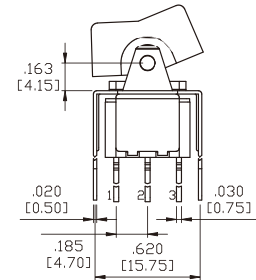
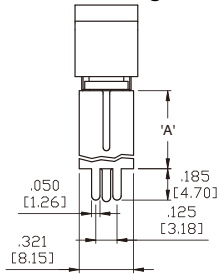

OPTION CODE	DIM.'A'
VS2	.461 [11.70]
VS3	.630 [16.00]

### P.C.MOUNTING

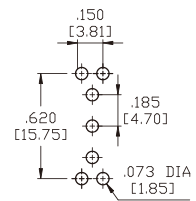

### VS2-VS3 Double Pole

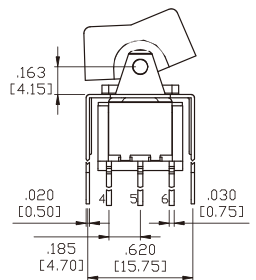
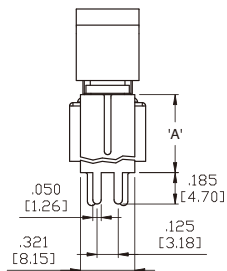

OPTION CODE	DIM.'A'
VS2	.461 [11.70]
VS3	.630 [16.00]

### P.C.MOUNTING

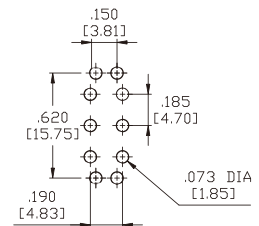

# 1M1-Series Dimensional Specifications: in. [mm]

## Termination Options

### VS4-VS5 Single Pole

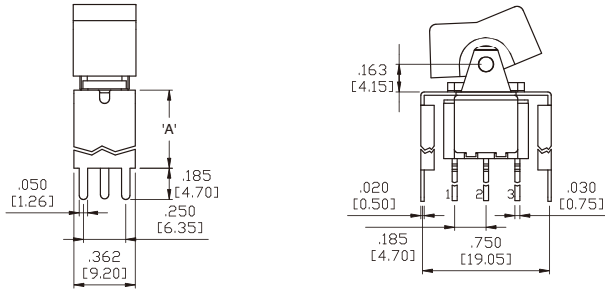

OPTION CODE	DIM. 'A'
<b>VS4</b>	.461 [11.70]
<b>VS5</b>	.630 [16.00]

### P.C.MOUNTING

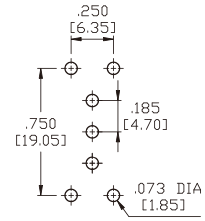

### VS4-VS5 Double Pole

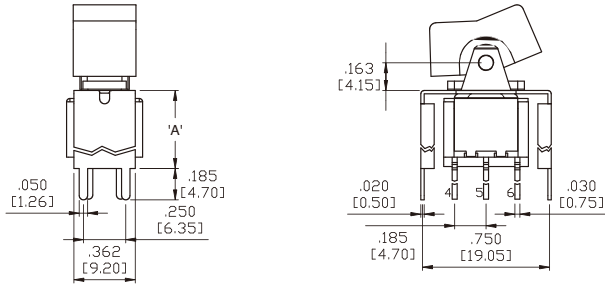

OPTION CODE	DIM. 'A'
<b>VS4</b>	.461 [11.70]
<b>VS5</b>	.630 [16.00]

### P.C.MOUNTING

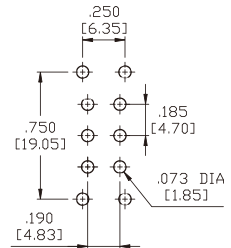

### U4-VS5 Three Pole

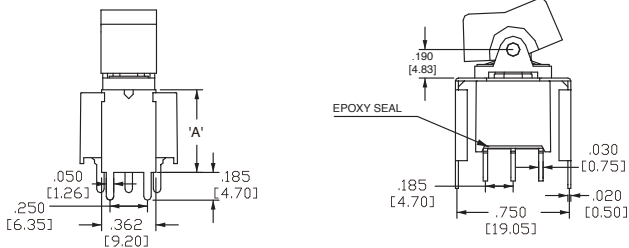

OPTION CODE	DIM. 'A'
<b>U4</b>	.551 [14.00]
<b>VS5</b>	.630 [16.00]

### P.C.MOUNTING

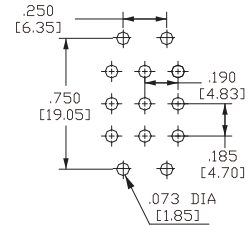

## Snap-In Termination Options

### M61

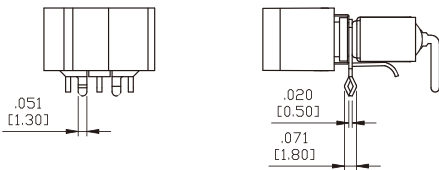

### VS21, VS31

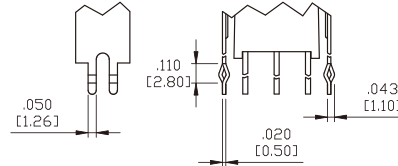

### VS41, VS51

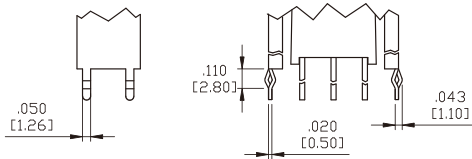

\* PC Mounting for M61, VS21, VS31, VS41, VS51 refer to M6, VS2, VS3, VS4, VS5 respectively.

## Authorized Sales Representatives and Distributors

Click on a region of the map below to find your local representatives and distributors or visit [www.carlingtech.com/findarep](http://www.carlingtech.com/findarep).



## About Carling

Founded in 1920, Carling Technologies is a leading manufacturer of electrical and electronic switches and assemblies, circuit breakers, electronic controls, power distribution units, and multiplexed power distribution systems. With four ISO registered manufacturing facilities and technical sales offices worldwide, Carling Technologies Sales, Service and Engineering teams do much more than manufacture electrical components, they engineer powerful solutions! To learn more about Carling please visit [www.carlingtech.com/company-profile](http://www.carlingtech.com/company-profile).

To view all of Carling's environmental, quality, health & safety certifications please visit [www.carlingtech.com/environmental-certifications](http://www.carlingtech.com/environmental-certifications)

## **Worldwide Headquarters**

Carling Technologies, Inc.  
60 Johnson Avenue, Plainville, CT 06062  
**Phone:** 860.793.9281 **Fax:** 860.793.9231  
**Email:** sales@carlingtech.com

**Northern Region Sales Office:** nrsm@carlingtech.com  
**Southeast Region Sales Office:** sersm@carlingtech.com  
**Midwest Region Sales Office:** mrsm@carlingtech.com  
**West Region Sales Office:** wrsm@carlingtech.com  
**Latin America Sales Office:** larsm@carlingtech.com

## **Asia-Pacific Headquarters**

Carling Technologies, Asia-Pacific Ltd.,  
Suite 1607, 16/F Tower 2, The Gateway,  
Harbour City, 25 Canton Road,  
Tsimshatsui, Kowloon, Hong Kong  
**Phone:** Int + 852-2737-2277 **Fax:** Int + 852-2736-9332  
**Email:** sales@carlingtech.com.hk

**Shenzhen, China:** shenzhen@carlingtech.com  
**Shanghai, China:** shanghai@carlingtech.com  
**Pune, India:** india@carlingtech.com  
**Kaohsiung, Taiwan:** taiwan@carlingtech.com  
**Yokohama, Japan:** japan@carlingtech.com

## **Europe | Middle East | Africa Headquarters**

Carling Technologies LTD  
4 Airport Business Park, Exeter Airport,  
Clyst Honiton, Exeter, Devon, EX5 2UL, UK  
**Phone:** Int + 44 1392.364422 **Fax:** Int + 44 1392.364477  
**Email:** ltd.sales@carlingtech.com

**Germany:** gmbh@carlingtech.com  
**France:** sas@carlingtech.com



**Carling Technologies®**

Innovative Designs. Powerful Solutions.