

MAX98356 Evaluation Kit

Evaluates: MAX98356

General Description

The MAX98356 evaluation kit (EV kit) is a fully assembled and tested PCB that evaluates the MAX98356 PDM digital input Class D power amplifier. The EV kit operates from a single 2.5V to 5.5V DC power supply and is capable of delivering 3.2W into a 4Ω load. The device outputs can be connected directly to a speaker load for filterless applications. However, a filter can be added to ease evaluation.

Features

- ◆ 2.5V to 5.5V Single-Supply Operation
- ◆ Only a Single External Component (VDD Capacitor) Required in Many Applications
- ◆ PDM Digital Input
- ◆ Five Selectable Gains (3dB, 6dB, 9dB, 12dB, and 15dB)
- ◆ Supported PDM_CLK Rates of 1.84MHz to 4.32MHz and 5.28MHz to 8.64MHz
- ◆ Audio Channel Select (Left, Right, (Left + Right)/2)
- ◆ Filterless Class D Outputs
- ◆ Optional Class D Output Filters for Ease of Evaluation
- ◆ Low-Power Shutdown Mode
- ◆ Low RF Susceptibility Rejects TDMA Noise from GSM Radios
- ◆ Extensive Click-and-Pop Reduction Circuitry
- ◆ Robust Short-Circuit and Thermal Protection
- ◆ Proven PCB Layout
- ◆ Fully Assembled and Tested

[Ordering Information](#) appears at end of data sheet.

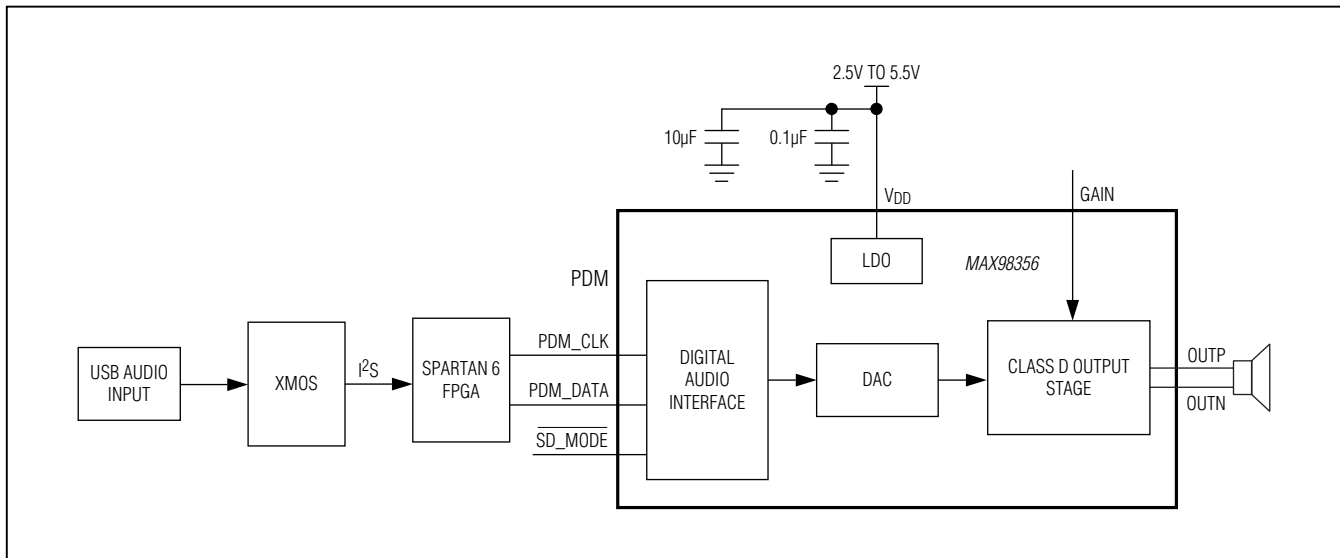

Figure 1. Simplified Block Diagram

MAX98356 Evaluation Kit

Evaluates: MAX98356

Component List

DESIGNATION	QTY	DESCRIPTION
BCLK, LRCLK, MCLK, SDIN, SDOUT, USB5V, XMCLK	0	Not installed, test points
C1	1	10 μ F \pm 10%, 6.3V X5R ceramic capacitor (0603) Murata GRM188R60J106K
C2, C201–C203, C218–C220, C222, C225–C228, C231–C234, C340–C349	26	0.1 μ F \pm 10%, 16V X7R ceramic capacitors (0402) Murata GRM155R71C104K
C3–C9, C12, C13, C302–C306	0	Not installed, ceramic capacitors (0402)
C200, C204, C205	3	1 μ F \pm 10%, 6.3V X5R ceramic capacitors (0402) TDK C1005X5R0J105K
C206, C235, C236	3	0.01 μ F \pm 10%, 50V X7R ceramic capacitors (0603) Murata GRM188R71H103K
C207, C208, C213, C330	4	1 μ F \pm 20%, 6.3V X5R ceramic capacitors (0603) Taiyo Yuden JMK107B7105MA
C209, C210, C312, C313, C328	5	2.2 μ F \pm 10%, 6.3V X5R ceramic capacitors (0603) Murata GRM188R60J225K
C212	1	1000pF \pm 10%, 50V X7R ceramic capacitor (0603) Murata GRM188R71H102K
C214–C217	4	33pF \pm 5%, 50V C0G ceramic capacitors (0603) Murata GRM1885C1H330J
C221	1	330pF \pm 5% 50V C0G ceramic capacitor (0603) Murata GRM1885C1H331J
C223, C224	2	4.7 μ F \pm 10%, 10V X5R ceramic capacitors (0805) Murata GRM219R61A475K
C229, C230	2	4.7 μ F \pm 10%, 6.3V X5R ceramic capacitors (0603) Murata GRM188R60J475K
C301	1	100 μ F \pm 20%, 6.3V X5R ceramic capacitor (1210) Murata GRM32ER60J107M TDK C3225X5R0J107M

DESIGNATION	QTY	DESCRIPTION
C320	1	0.001 μ F \pm 10%, 50V X7R ceramic capacitor (0402) Murata GRP155R71H102K
C321, C327	2	22 μ F \pm 10%, 6.3V X5R ceramic capacitors (1206) Murata GRM31CR60J226K
C324	1	10 μ F \pm 10%, 6.3V X5R ceramic capacitor (0603) Murata GRM188R60J106K
C325	1	0.47 μ F \pm 10%, 6.3V X5R ceramic capacitor (0402) Murata GRM155R60J474K
C331	1	470pF \pm 10%, 50V C0G ceramic capacitor (0402) Murata GRM1555C1H471J TDK C1005C0G1H471J
C332	1	150 μ F, 4V SP capacitor (7.3mm x 4.3mm x 1.9mm) Panasonic EEFSX0G151ER
CE	1	Red test point
D200	1	Red LED (0603)
FB1, FB2	2	0 Ω \pm 5% resistors (0603)
FB200, FB201	2	Ferrite beads (0603) Murata BLM18KG331SN1
FOUTN, FOUTP, GND (x4), +3.3V, VDD, +5V	9	20G plated, solid copper 0.25in U-shaped wire loops
FOUTN, FOUTP, GND, +5V	4	Binding posts
FPGA1.2V, FPGA1.8V, FPGA3.3V, OOTP, PDM_CLK, PDM_DATA	6	Red multipurpose test points (63 mil drill size)
J1	1	USB mini-AB receptacle
J200	1	20-pin (2 x 10) IDC right-angle, polarized boxed header, 0.1in centers
J300	1	14-pin JTAG connector
J301	1	16-pin (2 x 8) straight header, 0.1in centers
JU1	1	5-pin header
JU2	1	4-pin header
JU3	1	6-pin (3 x 2) header
JU4, JU8	2	2-pin headers

MAX98356 Evaluation Kit

Evaluates: MAX98356

Component List (continued)

DESIGNATION	QTY	DESCRIPTION
JU5	1	3-pin header
JU6	1	15-pin (3 x 15) header
LEDA, LEDB	2	Green LEDs (0603)
L1, L2	0	Not installed, 22 μ H inductors (6.2mm x 6.3mm)—short (PC trace) TOKO D63CB series part TOKO A916CY-220M
L201	1	3.3 μ H, 1.1A power inductor Sumida CDRH3D16NP-3R3NC
L300	1	3.3 μ H, 57m Ω , 1.3A inductor (5mm x 5mm x 2 mm) Sumida CDRH4D18ENP-3R3N
L301	1	2.2 μ H, 36m Ω , 3A inductor (6mm x 6mm x 1.8 mm) Sumida CDRH5D16NP-2R2N
OUTN	1	Black multipurpose test point, 63 mil drill size
P1	1	R/A power jack, (2.1mm ID, 5.5mm OD)
Q200, Q201, Q202	3	n-channel enhancement-mode FETs (SOT23) Fairchild BSS138
R1, R2, R201, R334–R341	11	100k Ω \pm 5% resistors (0603)
R3	1	174k Ω \pm 1% resistor (0603)
R4	1	634k Ω \pm 1% resistor (0603)
R5, R6	0	Not installed, resistors (0402)
R10	1	2k Ω \pm 1% resistor (0603)
R36, R37, R300–R304, R324–R332, R333	17	0 Ω \pm 5% resistors (0402)
R200	1	27k Ω \pm 5% resistor (0603)
R203, R204, R207, R210, R217, R220, R322	7	10k Ω \pm 5% resistors (0603)
R205, R213	2	47k Ω \pm 5% resistors (0603)
R206, R310–R312, R323	5	4.7 Ω \pm 5% resistors (0603)
R208	1	20k Ω \pm 5% resistor (0603)
R209	0	Not installed resistor (0603)
R211	1	8.06k Ω \pm 1% resistor (0603)
R212, R219, R233, R234	4	1k Ω \pm 5% resistors (0603)

DESIGNATION	QTY	DESCRIPTION
R218, R221	2	2.2M Ω \pm 5% resistors (0603)
R222	1	470 Ω \pm 5% resistor (0603)
R223, R224	2	33 Ω \pm 5% resistors (0603)
R308	1	330 Ω \pm 5% resistor (0603)
R313	1	100 Ω \pm 5% resistor (0402)
R314	1	10 Ω \pm 5% resistor (0402)
R316, R318	0	Not installed, resistors—short (PC trace) (1206)
R317	1	0 Ω \pm 5% resistor (0603)
R342	1	39.2k Ω \pm 1% resistor (0603)
SW300	1	8-position DIP switch (SMD)
U1	1	I ² S input Class D audio amplifier (9 WLP) Maxim MAX98356EWL+
U200	1	XMOS Processor (128 TQFP)
U201	1	SPI 1Mb flash memory (8 SO)
U202	1	USB 2.0 ULPI transceiver (24 QFN)
U203	1	3.3V low-noise linear regulator (5 SOT23) Maxim MAX8887EZK33+T
U204, U305	2	1.8V low-noise linear regulators (5 SC70) Maxim MAX8511EXK18+
U205	1	Voltage detector (5 SOT23)
U206	1	TinyLogic UHS dual buffer (6 SC70) Fairchild NC7WZ07P6X
U208	1	Dual unbuffered inverter (6 SC70) Fairchild NC7WZU04P6X
U209	1	2-input multiplexer (6 SC70) Fairchild NC7SZ157P6X
U210	1	Dual logic buffer (6 SC70) Fairchild NC7WZ17P6X
U211	1	Microprocessor-reset circuit (3 SC70) Maxim MAX803TEXR+
U212	1	1A step-down regulator (μ MAX [®]) Maxim MAX1974EUB+

MAX98356 Evaluation Kit

Evaluates: MAX98356

Component List (continued)

DESIGNATION	QTY	DESCRIPTION
U300	1	324-pin Spartan 6 FPGA (15mm x 15mm, 0.8mm pitch)
U301	1	1.8V, 16MB flash (48 TSOP)
U304	1	1.2V, 1A step-down regulator (10 TDFN-EP*) Maxim MAX1556AETB+
U306	1	3.3V, 3A step-down regulator (16 QSOP) Maxim MAX1831EEE
U307-U309	3	4V reset circuits (3 SOT23) Maxim MAX809JEU+T

DESIGNATION	QTY	DESCRIPTION
Y1	1	13MHz clock oscillator (2.5mm x 2.0mm)
Y200	1	24.576MHz crystal (6.0mm x 3.3mm)
Y201	1	11.2896MHz crystal (6.0mm x 3.3mm)
—	5	Shunts
—	1	PCB: MAX98356 EVALUATION KIT

*EP = Exposed pad.

Optional Components

DESIGNATION	QTY	DESCRIPTION
C3-C7	5	0.22 μ F \pm 10%, 6.3V XR5 ceramic capacitors (0402) TDK C1005X5R0J224K

DESIGNATION	QTY	DESCRIPTION
L1, L2	2	22 μ H, 1A inductors (6.2mm x 6.3mm) TOKO A916CY-220M
R5, R6	2	22 Ω \pm 5% resistors (0402)

Component Suppliers

SUPPLIER	PHONE	WEBSITE
Fairchild Semiconductor	888-522-5372	www.fairchildsemi.com
Murata Electronics North America, Inc.	770-436-1300	www.murata-northamerica.com
Panasonic Corp.	800-344-2112	www.panasonic.com
Sumida Corp.	847-545-6700	www.sumida.com
Taiyo Yuden	800-348-2496	www.t-yuden.com
TDK Corp.	847-803-6100	www.component.tdk.com
TOKO America, Inc.	847-297-0070	www.tokoam.com

Note: Indicate that you are using the MAX98356 when contacting these component suppliers.

MAX98356 Evaluation Kit

Evaluates: MAX98356

Quick Start

Recommended Equipment

- MAX98356 EV kit
- 5V, 5A DC power supply
- USB audio source (from computer through an audio media player such as itunes or Windows Media player)
- USB cable (included in the EV kit box)
- 4Ω to 8Ω speaker

Procedure

The EV kit is fully assembled and tested. Follow the steps below to verify board operation. **Caution: Do not turn on the power supply until all necessary connections are completed.**

- 1) Verify that shunts are installed as follows:
 - JU1: Pins 1-5 (12dB gain)
 - JU2: Pins 1-3 (left audio channel selected)
 - JU3: Pins 2-3 (PDM from the FPGA to the IC)
 - JU4: Installed (VDDIO supplied from on-board power supply)
 - JU5: Pins 2-3 (device in shutdown mode)
 - JU6: Pins 2-3 (I²S from XMOS IC to Xilinx® FPGA)
 - JU8: Installed (VDD supplied by voltage at the +5V PCB pad)
- 2) Set the power-supply output to 5V. Disable the power supply.
- 3) Connect the power-supply ground terminal to the GND binding post and the power-supply positive terminal to the +5V binding post on the EV kit.
- 4) Connect the speaker across the OOUTP and OOUTN test points.
- 5) Enable the power-supply output.
- 6) Change the shunt on JU5 to pins 1-2 (device enabled for normal operation).
- 7) With the audio source disabled, connect the USB audio source to J1 on the EV kit.
- 8) Enable the audio source.
- 9) Verify that the speakers are playing the audio source signal.

Detailed Description of Hardware

Filterless Output

The MAX98356 EV kit's filterless outputs (OOUTP, OOUTN) can be connected directly to a speaker load without any filtering. Use the OOUTP and OOUTN test points to connect the speaker directly to the device output.

Filtered Output

Audio analyzers typically cannot accept the Class D amplifier's pulse-width modulated (PWM) signals at their inputs. Therefore, the EV kit features optional lowpass filters at the outputs to ease evaluation. As shipped, the EV kit's lowpass filter RC components are unpopulated and L1/L2 are shorted on the PCB.

To use the filtered output posts (FOOUTP, FOOUTN), remove the shorts on L1–L2 and install components L1/L2, C3–C7, and R5/R6 (provided separately with the EV kit). Use the output posts to connect the filtered outputs to the audio analyzer. The default lowpass filters at the EV kit output are optimized for an 4Ω speaker.

Jumper Selection

Selectable Gain (GAIN)

The EV kit features a 5-pin jumper JU1 to control the device's five programmable gain settings. See Table 1 for gain-control configuration.

Table 1. JU1 Jumper Selection (GAIN)

SHUNT POSITION	GAIN PIN	GAIN (dB) RELATIVE TO A 2.1dBV REFERENCE LEVEL
1-2	Connected to VDD through 100kΩ resistor R1	3
1-3	Connected to VDD	6
1-4	Connected to GND through 100kΩ resistor R2	15
1-5*	Connected to GND	12
Not installed	Unconnected	9

*Default position.

MAX98356 Evaluation Kit

Evaluates: MAX98356

SD_MODE Input

The EV kit features a 4-pin jumper (JU2) to control the audio channel that is sent to the amplifier output and a 3-pin jumper (JU5) to enable/disable the IC. JU2 is used to select the stereo input (left channel, right channel, or the average of the left/right channels). JU5 must be set to pins 1-2 for normal operation. See Table 2 for shunt positions.

Note: The (Left + right)/2 mode is only supported for the lower PDM_CLK range (1.84MHz to 4.32MHz).

Shutdown Mode

The device features a low-power shutdown mode that is activated by setting jumper JU5 to pins 2-3. To exit shutdown mode, set JU5 to pins 1-2 and select the desired stereo input channel using jumper JU2. See Table 2 for shunt positions.

Table 2. JU2 Jumper Selection (SD_MODE)

SHUNT POSITION		<u>SD_MODE</u> PIN	DEVICE OPERATION
JU2	JU5		
1-2	1-2*	Connected to VDDIO through R3 (226kΩ resistor)	Right audio channel selected
1-3*	1-2*	Connected to VDDIO	Left audio channel selected
1-4	1-2*	Connected to VDDIO through R4 (634kΩ resistor)	Mono mix (left + right)/2
X	2-3	Connected to GND	Shutdown

*Default position.

X = Don't care.

Table 3. JU5 Jumper Selection

SHUNT POSITION	VDDIO VOLTAGE	DEVICE OPERATION
1-2*	Supplied through the +3.3V pad	Normal (input channel selected through JU2 setting)
2-3	Connected to GND	Shutdown

*Default position.

Table 4. JU4 Jumper Selection

SHUNT POSITION	LOGIC VOLTAGE (VDDIO)
Installed*	3.3V supplied from the on-board power supply
Not installed	User-supplied external power supply applied at the +3.3V pad

*Default position.

External/Internal VDDIO (+3.3V)

On the EV kit, a logic voltage from a control interface is needed for proper selection of the stereo input channel through SD_MODE. This voltage can be applied externally at the +3.3V PCB pad, or it can be provided from on-board circuitry. See Table 4 for shunt positions.

Logic voltages other than +3.3V can be used on the EV kit. See the SD_MODE and Shutdown Operation section in the MAX98356 IC data sheet for more information.

External/Internal Input Supply (VDD)

The device can accept an input supply from 2.5V to 5.5V. This voltage can be applied externally at the VDD and GND PCB pads or provided from the main +5V on-board input required for the FPGA power supplies. See Table 5 for shunt positions.

FPGA

FPGA RESET Input (SW301)

The Xilinx FPGA can be reset by toggling switch SW301. The FPGA is in a reset state when the button is pushed and returns to normal operation when the button is released. The FPGA may need to be reset when switching between sample rates or bit depths.

Table 5. JU8 Jumper Selection

SHUNT POSITION	INPUT VOLTAGE (VDD)
Installed*	VDD supplied from the on-board power supply at the +5V net
Not installed	User-supplied external power supply applied at the VDD PCB pad

*Default position.

Table 6. JU3 Jumper Selection (Max98356 Digital Audio Interface)

SWITCH POSITION	PDM_CLK/ PDM_DATA	DEVICE OPERATION
2-3*	IC input connected to the FPGA output	Xilinx FPGA provides PDM input data to the IC.
Not installed	Unconnected	Use this configuration when connecting an external PDM source to the IC. Connect the external PDM_CLK/PDM_DATA to column 2 and GND to column 1.

*Default position.

MAX98356 Evaluation Kit

Evaluates: MAX98356

OSR Select Input (SW300-2)

SW300-2 can toggle the oversampling ratio that is used by the Xilinx FPGA to generate the PDM data. Toggle the switch to the on position for OSR = 128x or toggle the switch to the off position for OSR = 64x. Sample rates can be changed dynamically, but to avoid click/pop it is necessary to activate $\overline{\text{SD_MODE}}$ low (shutdown mode) during the transition. See Table 11 for SW300-2 configuration.

Signal Monitoring (J301)

J301 is provided for monitoring the FPGA signals or jumping them to another board for evaluation. See Table 10 for J301 pinout.

Table 7. JU6 Jumper Selection (Xilinx FPGA Digital Audio Interface)

SWITCH POSITION	MCLK/BCLK/LRCLK/SDIN	DEVICE OPERATION
2-3*	FPGA input connected to the XMOS output	XMOS IC provides I ² S input data to the Xilinx FPGA.
Not installed	Pulled to GND through R334	Use this configuration when connecting an external I ² S source to the FPGA. Connect the external MCLK/BCLK/LRCLK/SDIN to column 2 and GND to column 1.

*Default position.

Table 8. SW301 Input Selection

SWITCH POSITION	U300-C17 INPUT	OPERATION
On	Connected to +3.3V	FPGA reset
Off*	Pulled to GND through R334	Normal operation

*Default position.

Table 9. SW300-2 Input Selection

SWITCH POSITION	U300-C18 INPUT	OSR
On	Connected to +3.3V	128
Off*	Pulled to GND through R335	64

*Default position.

Driving I²S Directly

The EV kit provides an on-board XMOS chip to generate the I²S signal from the USB audio source. To utilize the XMOS chip, all positions of jumper JU6 must be set between pins 2-3. To bypass the XMOS and drive I²S directly to the FPGA, remove the shunts from JU6 and apply signals at the MCLK, BCLK, LRCLK, and SDIN test points or between JU6 pins 1-2 at the appropriate locations (pin 1 is signal ground). See Table 11 for a list of clock modes supported by the FPGA; note that the USB must be disconnected.

Driving PDM Directly

The device provides an on-board FPGA to convert the I²S signal to PDM. To utilize the FPGA, all positions of jumper JU3 must be set between pins 2-3. To bypass the FPGA and drive PDM directly, remove the shunts from JU3 and apply signals at the PDM_CLK and PDM_DATA test points, or between JU3 pins 1-2 at the appropriate locations (pin 1 is signal ground).

Table 10. J301 Pin Description

PIN	SIGNAL
1	PDM clock
3	PDM data
5	N.C.
7	MCLK
9	BCLK
11	SDIN
13	LRCLK
15	U301 $\overline{\text{CF}}$ pin
2, 4, 6, 8, 10, 12, 14, 16	GND

Table 11. Clock Modes Supported by the FPGA

MCLK (MHz)	LRCLK (kHz)	BCLK (MHz)	OSR	PDM CLOCK (MHz)
8.192	32	2.048	64	2.048
12.288	48	3.072	64	3.072
8.192	32	2.048	128	4.096
11.2896	44.1	2.8224	128	5.6448
12.288	48	3.072	128	6.144
16.384	64	4.096	128	8.192

MAX98356 Evaluation Kit

Evaluates: MAX98356

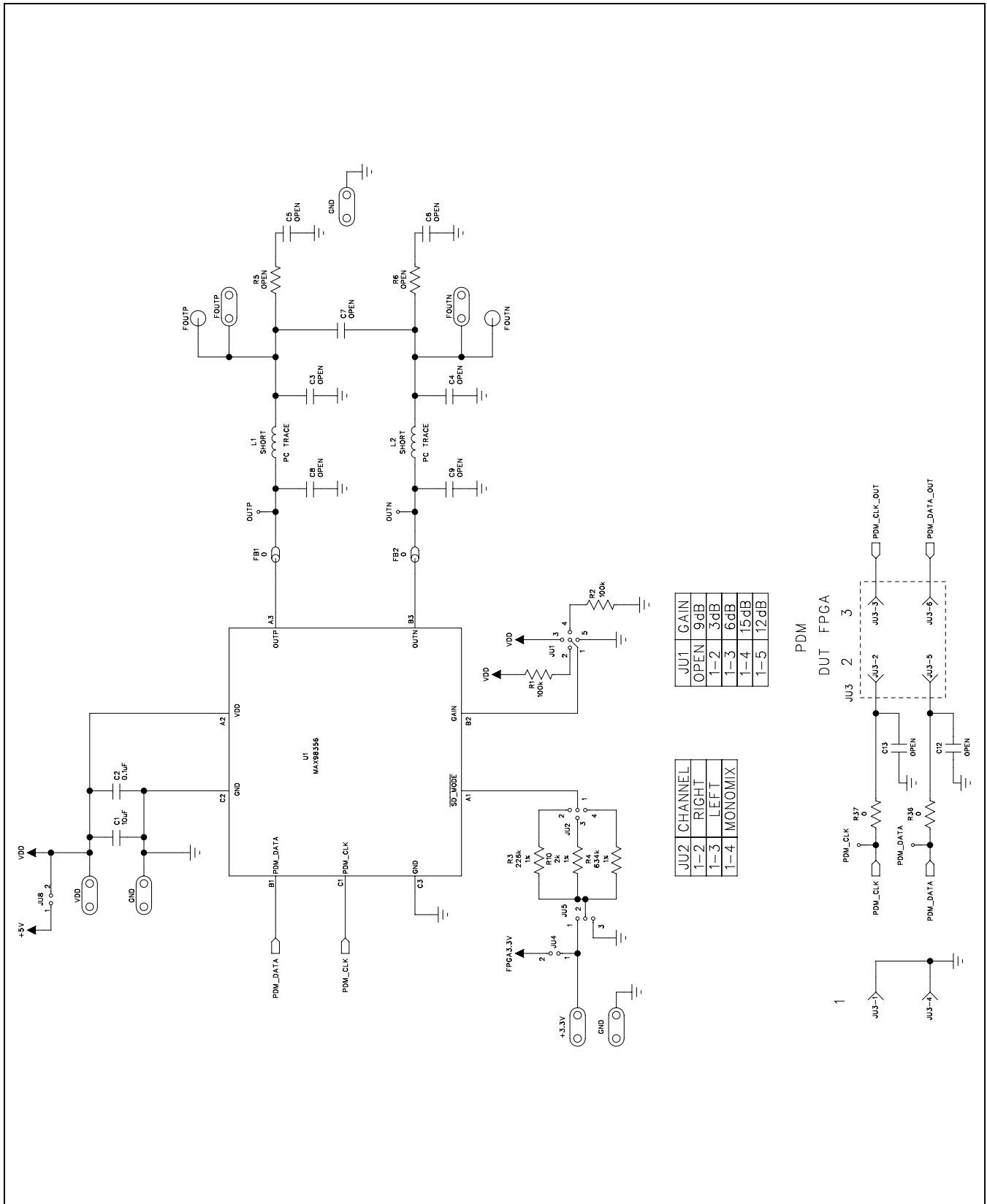

Figure 2a. MAX98356 EV Kit Schematic (Sheet 1 of 8)

MAX98356 Evaluation Kit

Evaluates: MAX98356

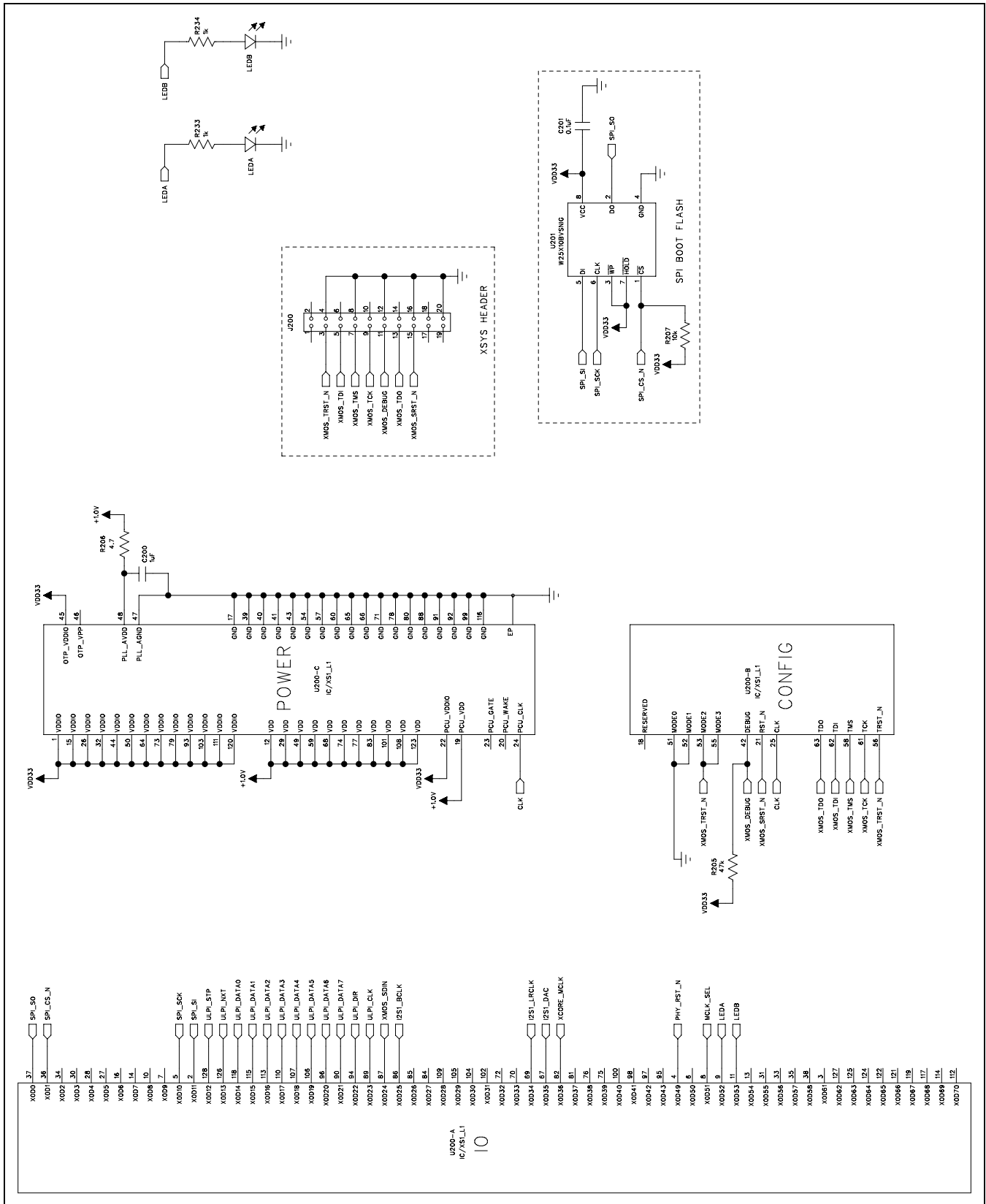

Figure 2b. MAX98356 EV Kit Schematic (Sheet 2 of 8)

MAX98356 Evaluation Kit

Evaluates: MAX98356

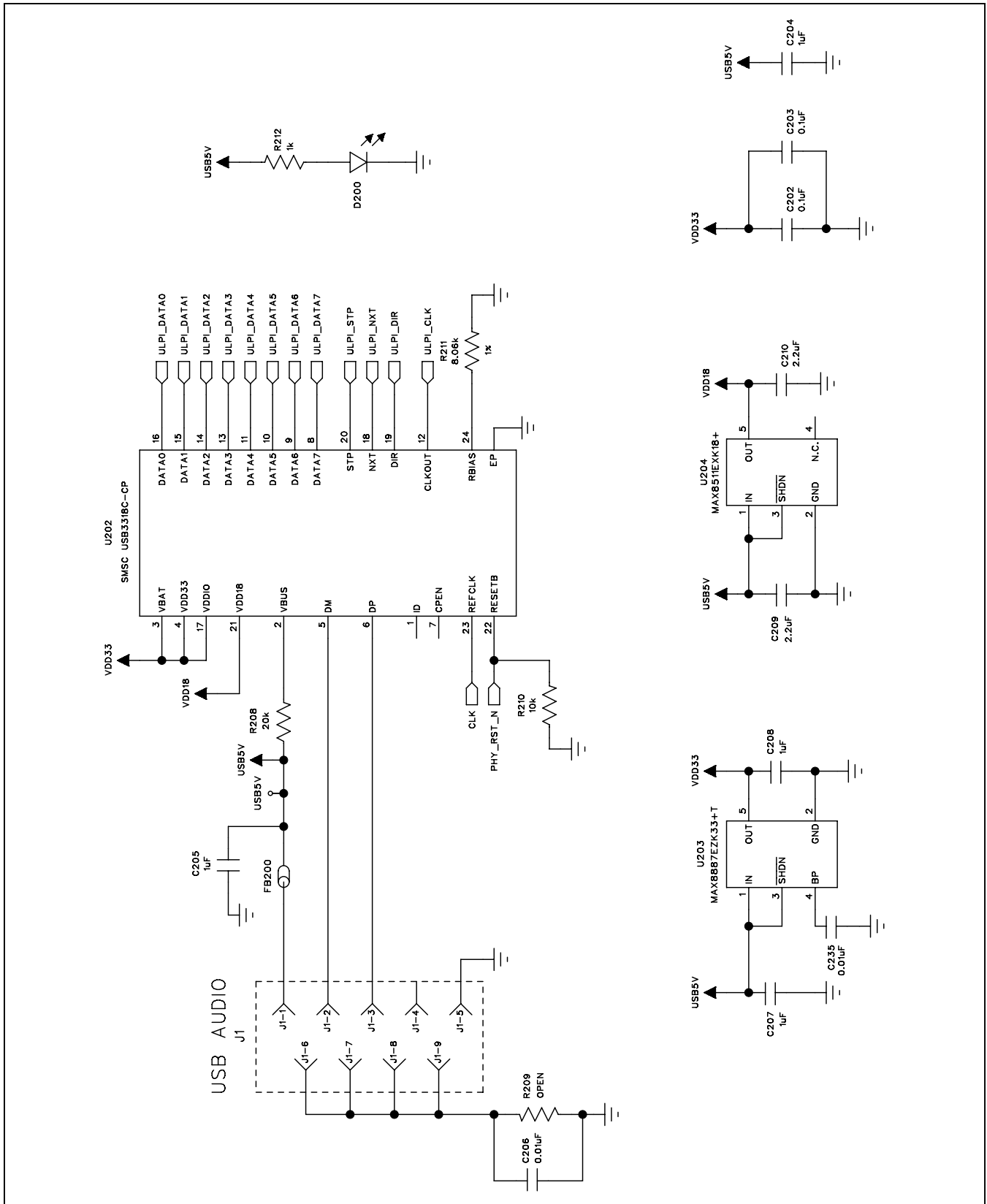

Figure 2c. MAX98356 EV Kit Schematic (Sheet 3 of 8)

MAX98356 Evaluation Kit

Evaluates: MAX98356

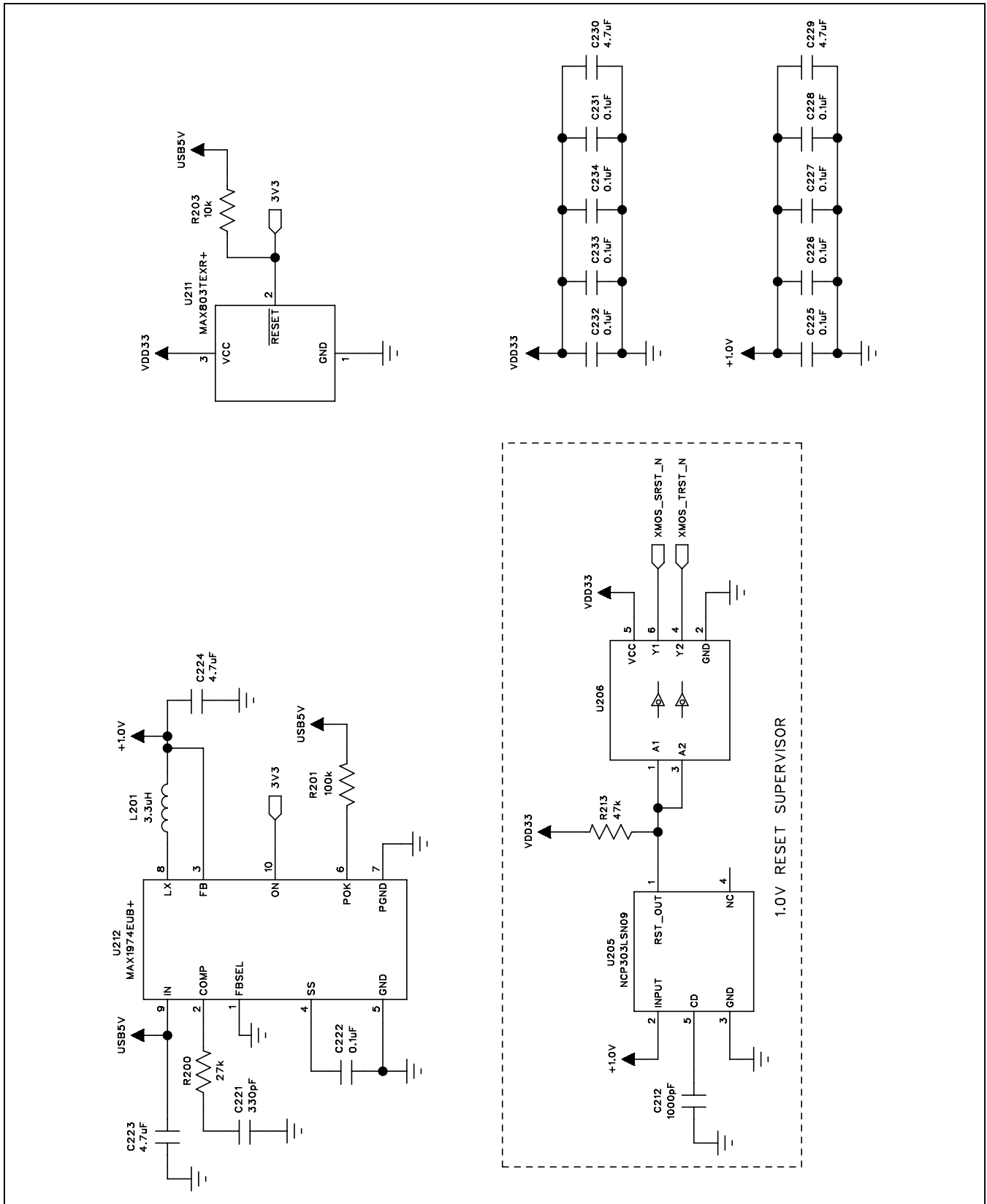

Figure 2d. MAX98356 EV Kit Schematic (Sheet 4 of 8)

MAX98356 Evaluation Kit

Evaluates: MAX98356

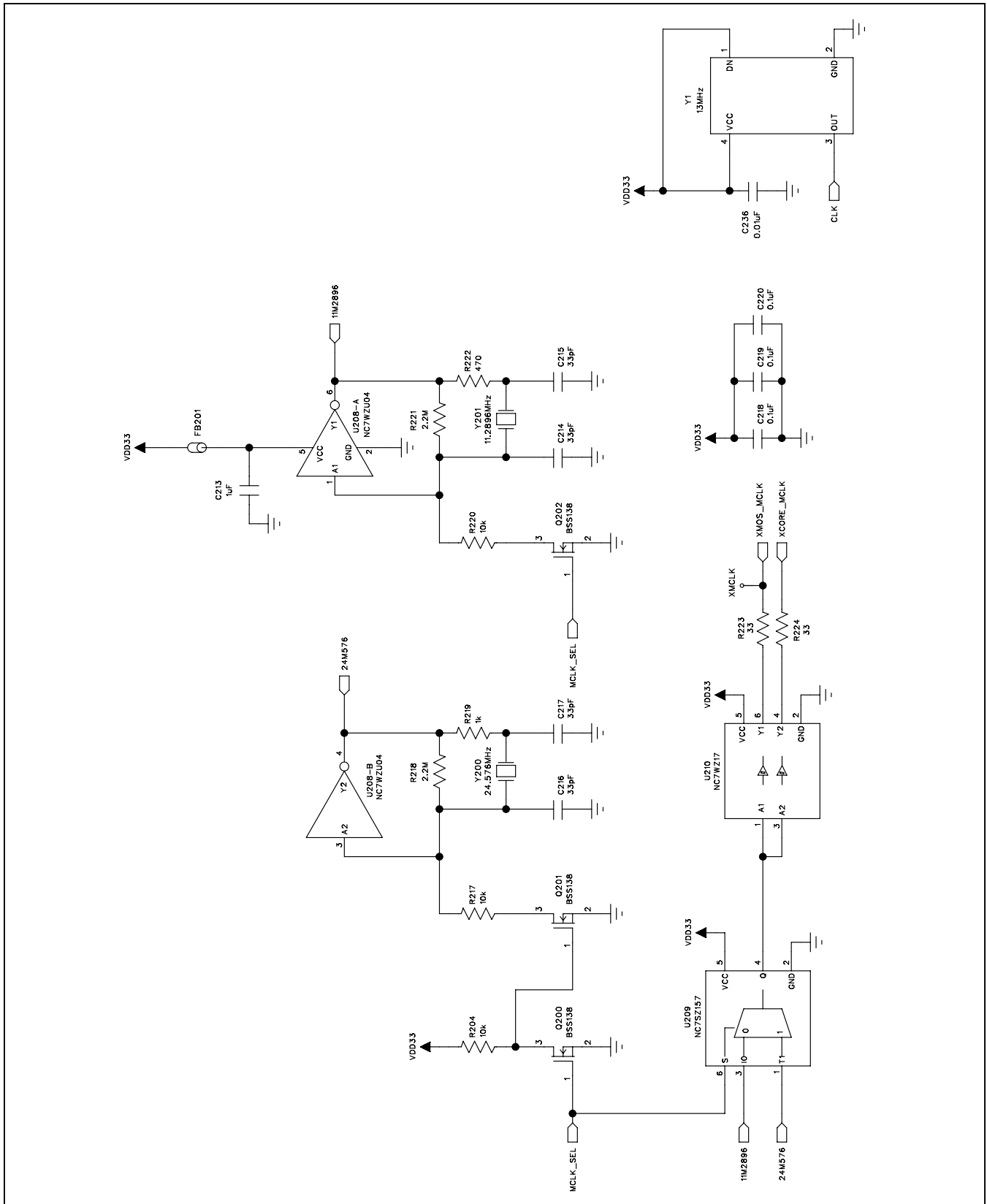

Figure 2e. MAX98356 EV Kit Schematic (Sheet 5 of 8)

MAX98356 Evaluation Kit

Evaluates: MAX98356

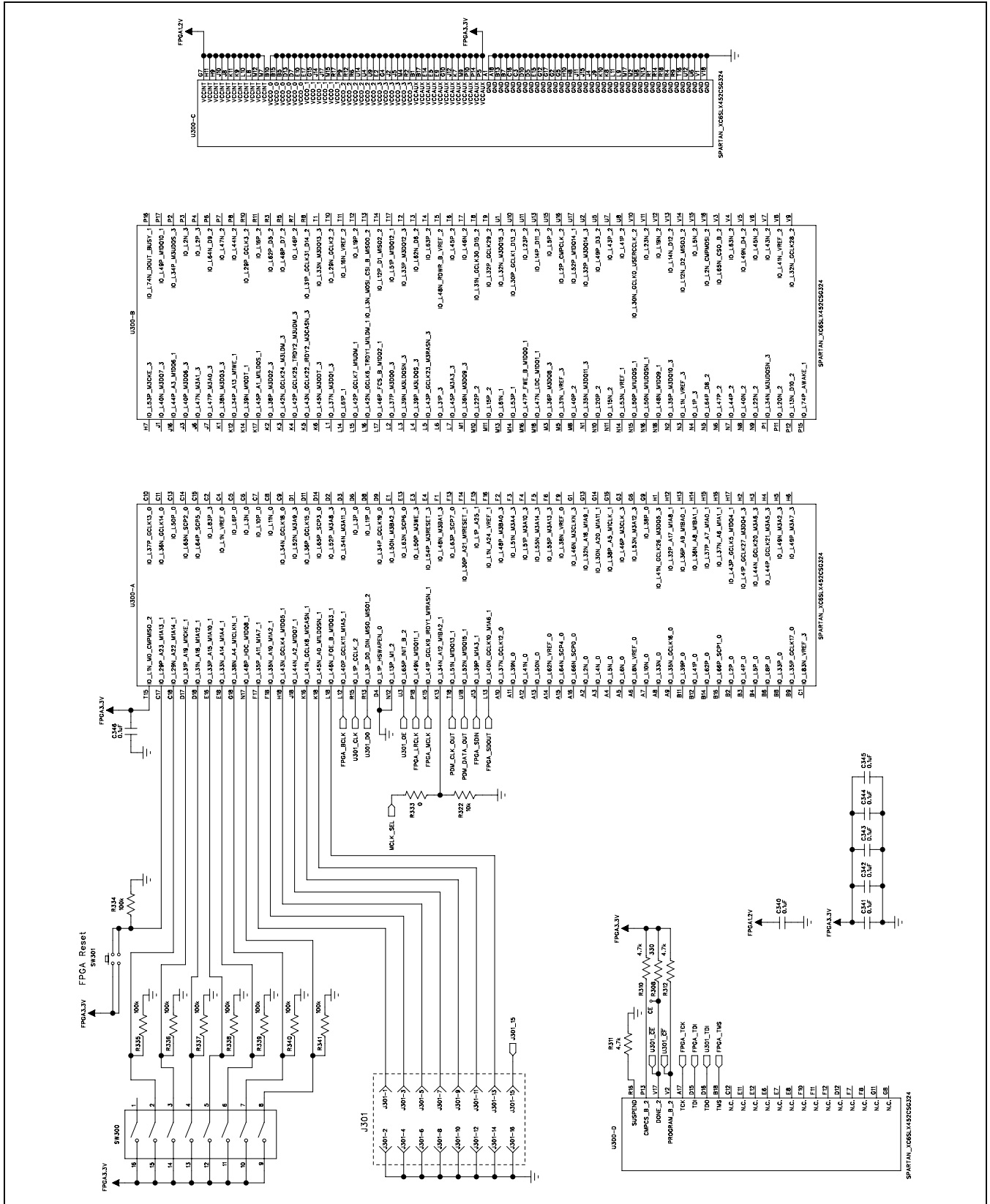

Figure 2f. MAX98356 EV Kit Schematic (Sheet 6 of 8)

MAX98356 Evaluation Kit

Evaluates: MAX98356

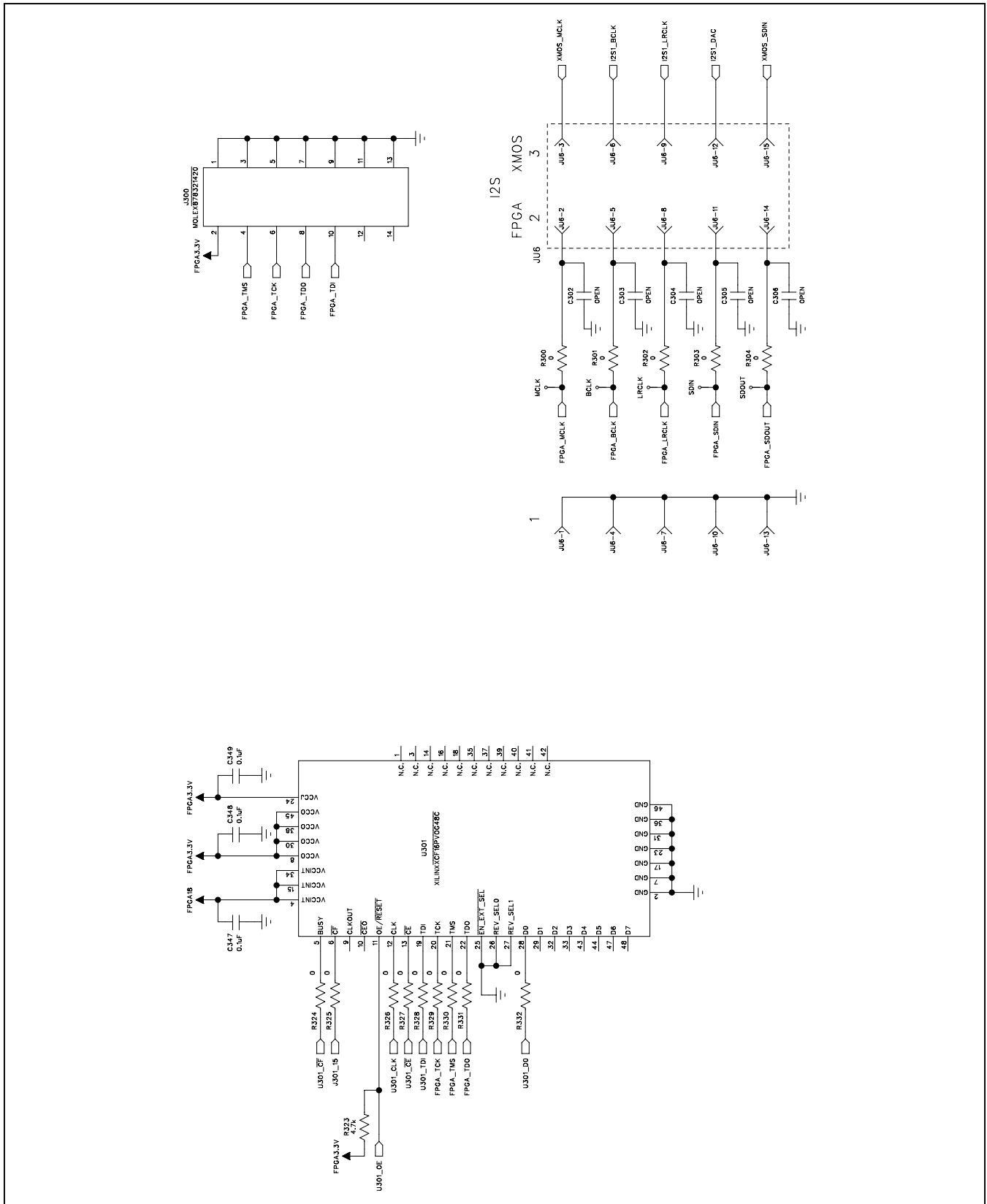

Figure 2g. MAX98356 EV Kit Schematic (Sheet 7 of 8)

MAX98356 Evaluation Kit

Evaluates: MAX98356

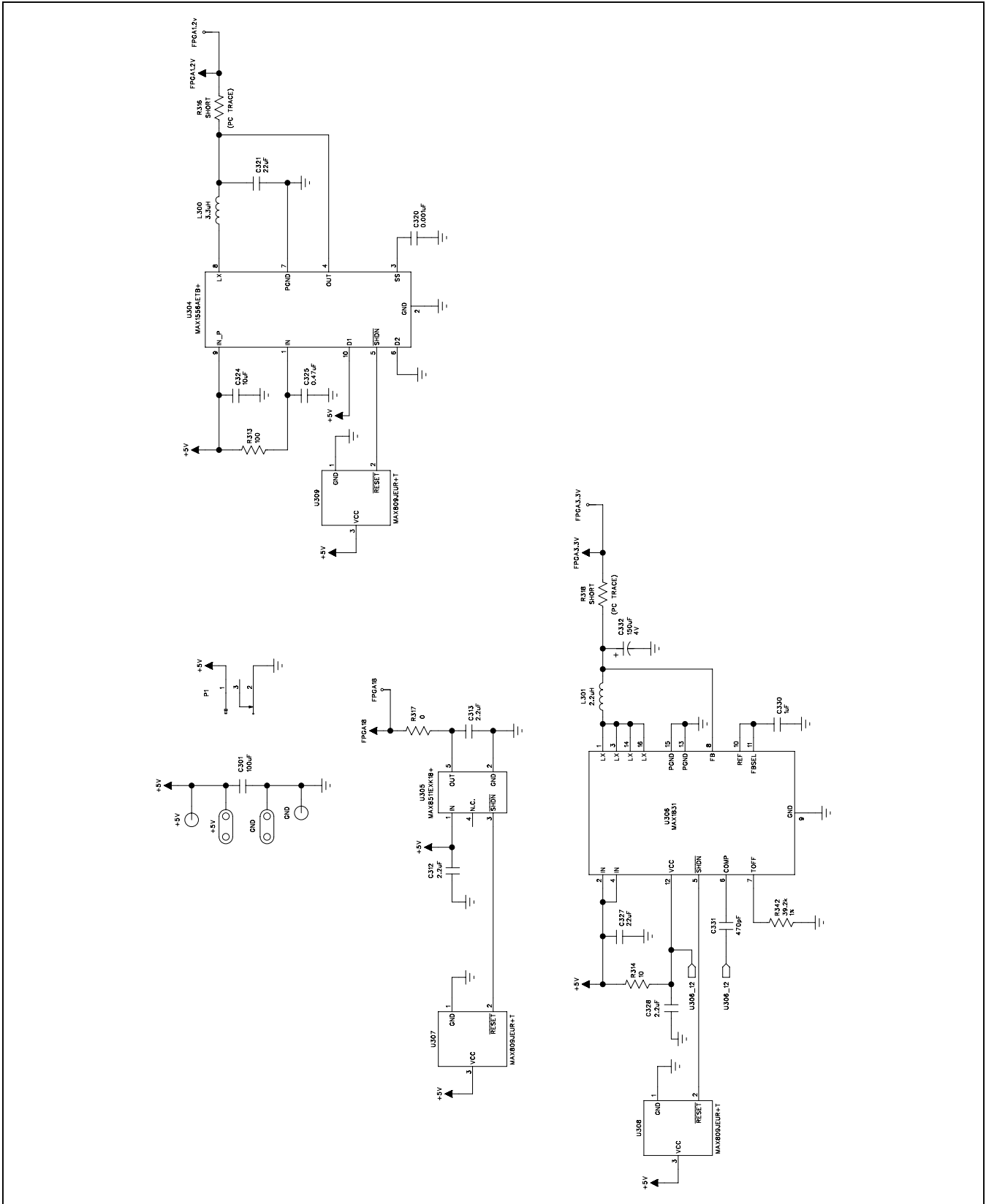

Figure 2h. MAX98356 EV Kit Schematic (Sheet 8 of 8)

MAX98356 Evaluation Kit

Evaluates: MAX98356

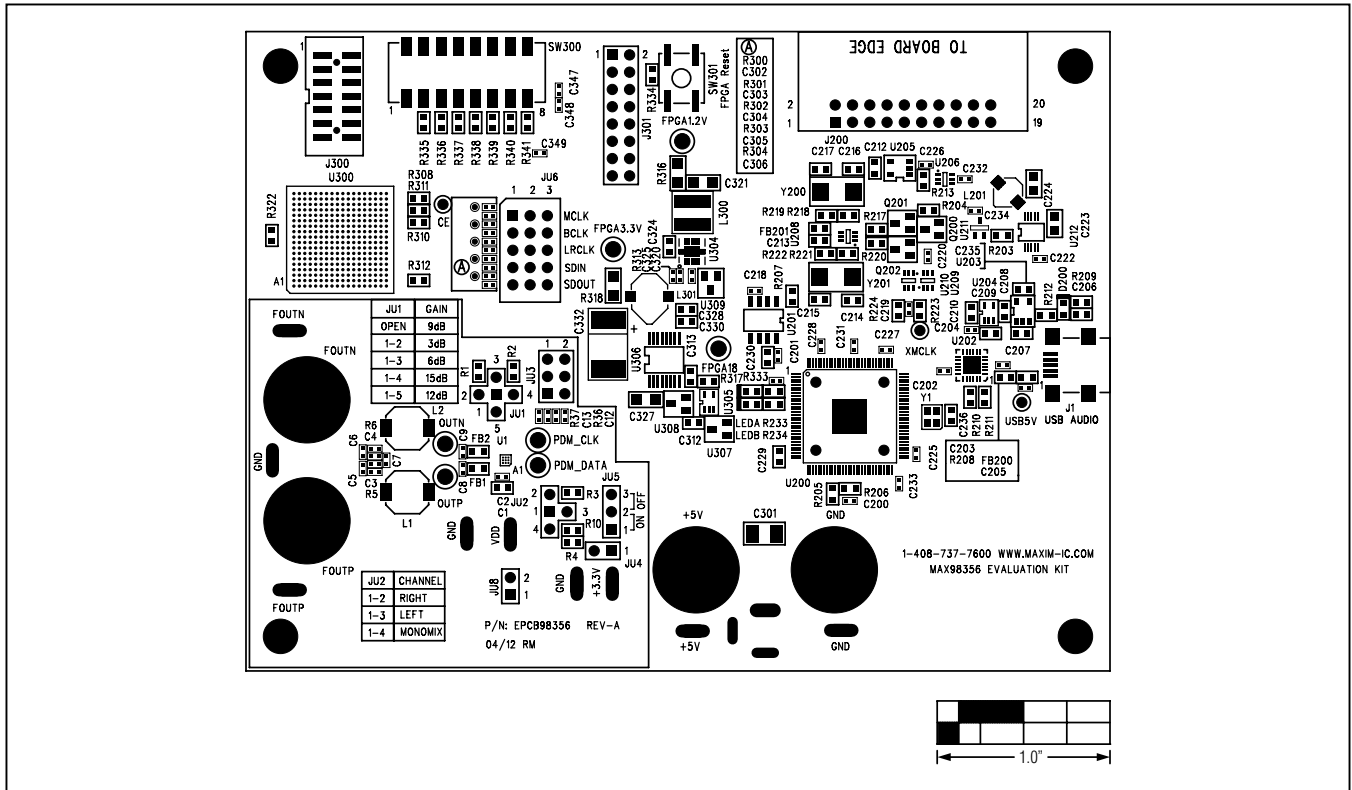

Figure 3. MAX98356 EV Kit Component Placement Guide—Component Side

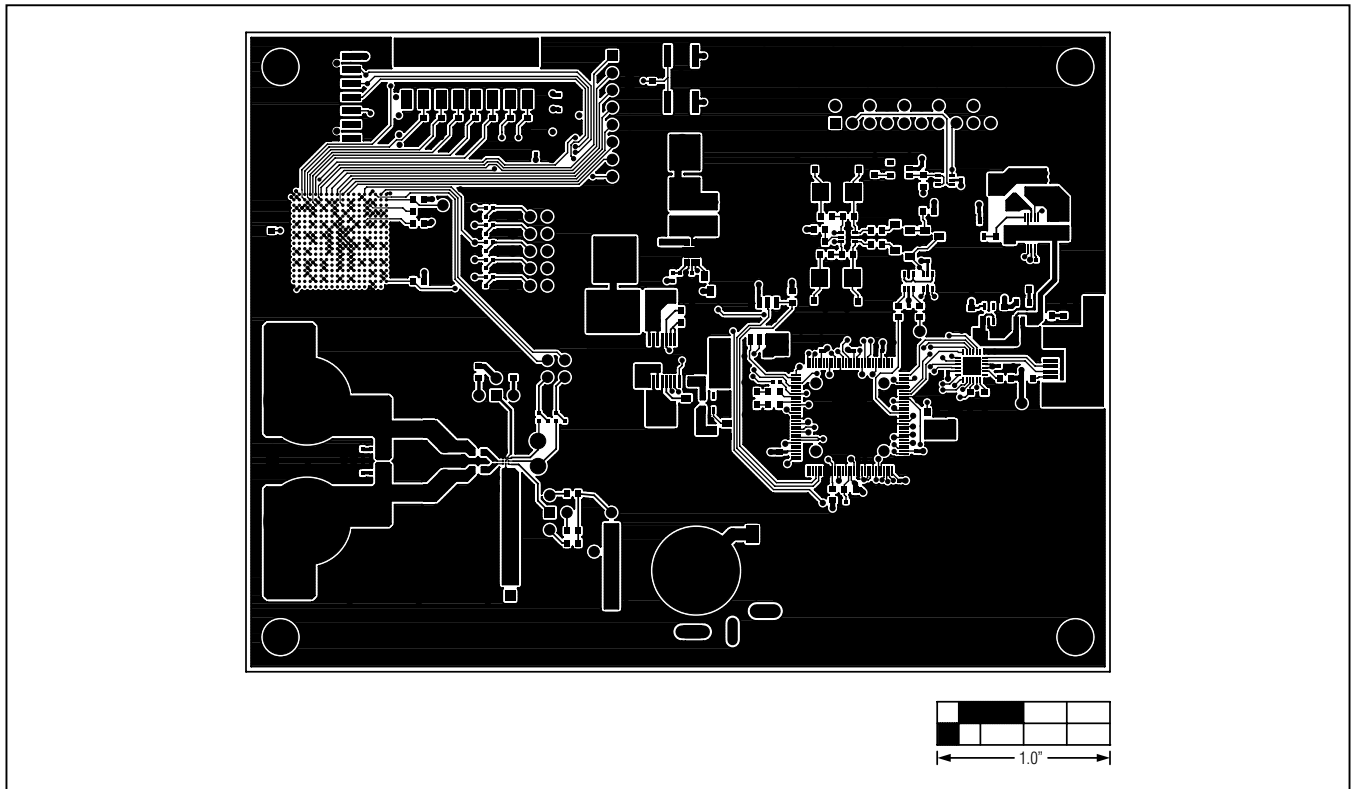

Figure 4. MAX98356 EV Kit PCB Layout—Component Side

MAX98356 Evaluation Kit

Evaluates: MAX98356

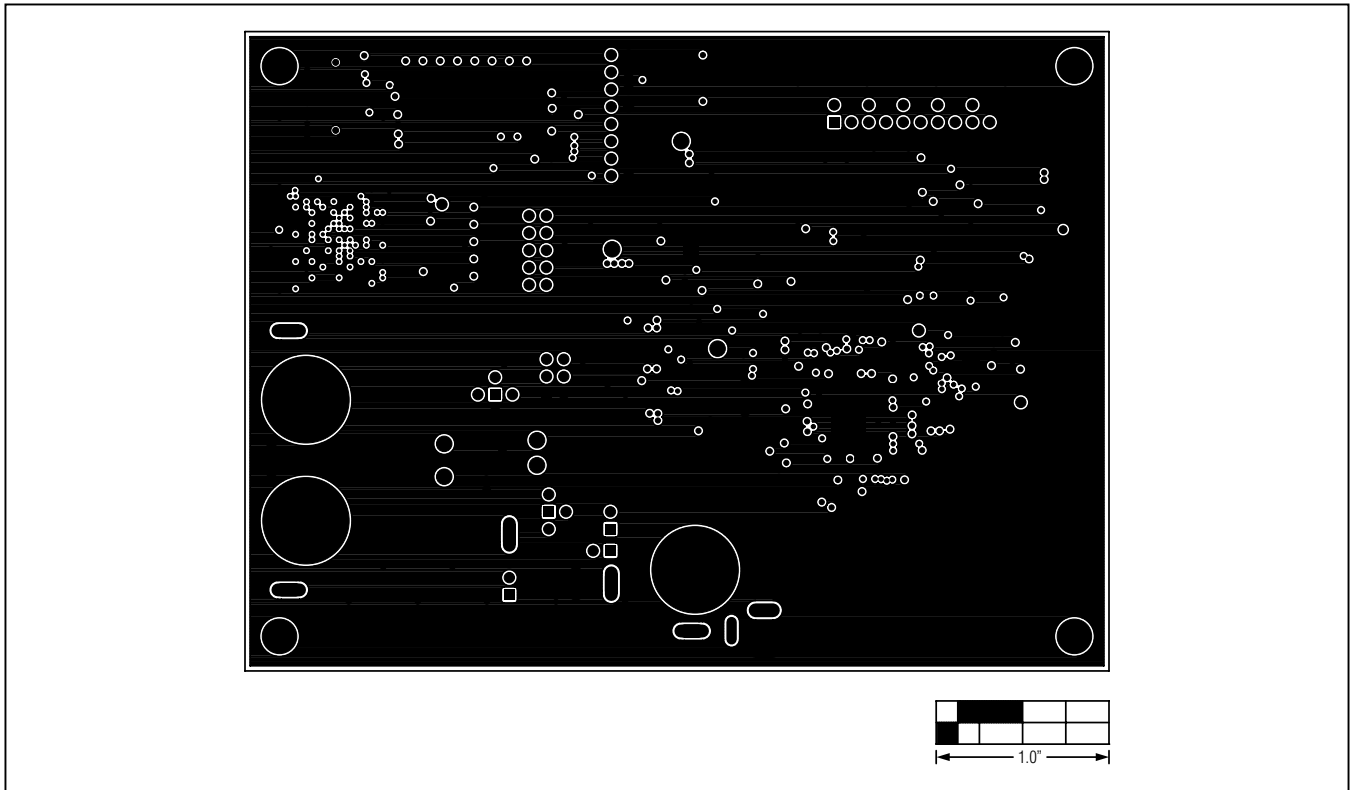

Figure 5. MAX98356 EV Kit PCB Layout—Layer 2

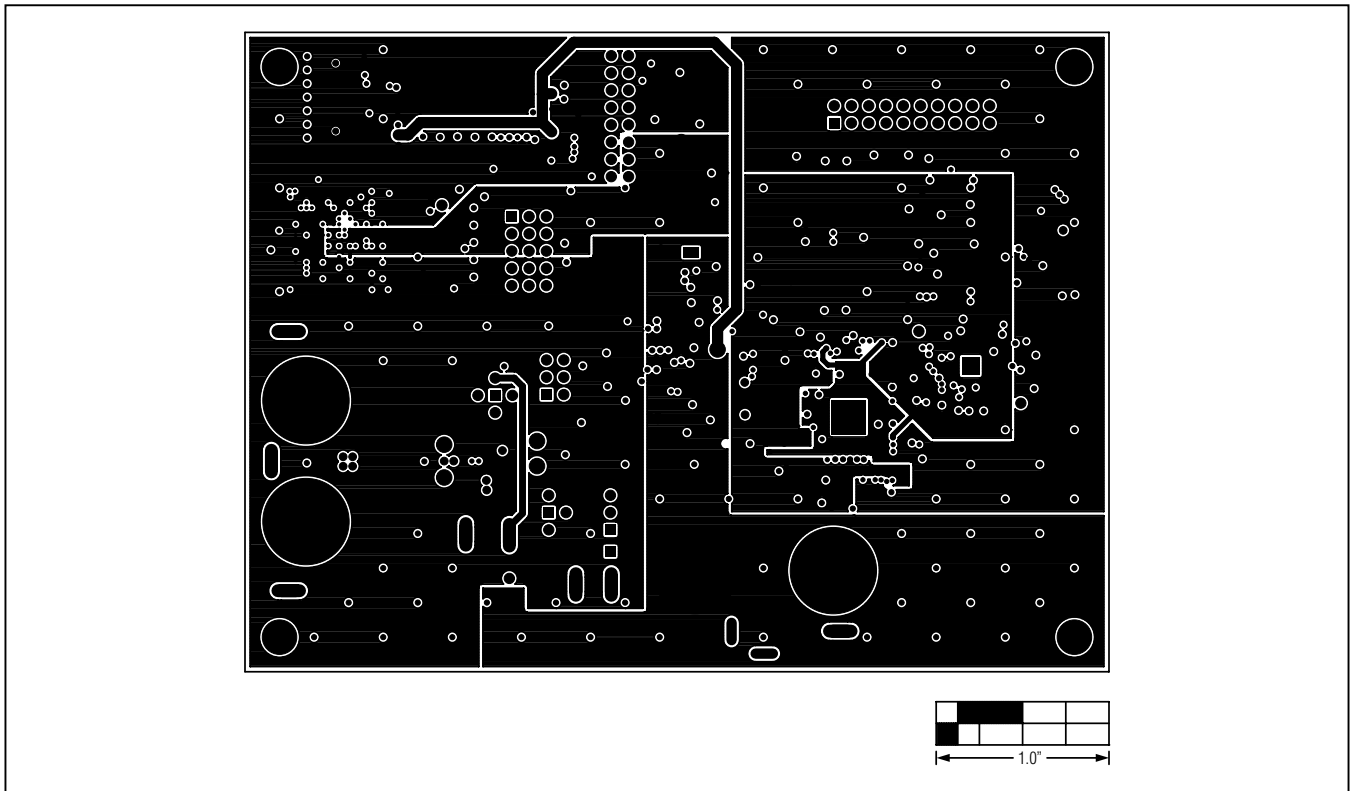

Figure 6. MAX98356 EV Kit PCB Layout—Layer 3

MAX98356 Evaluation Kit

Evaluates: MAX98356

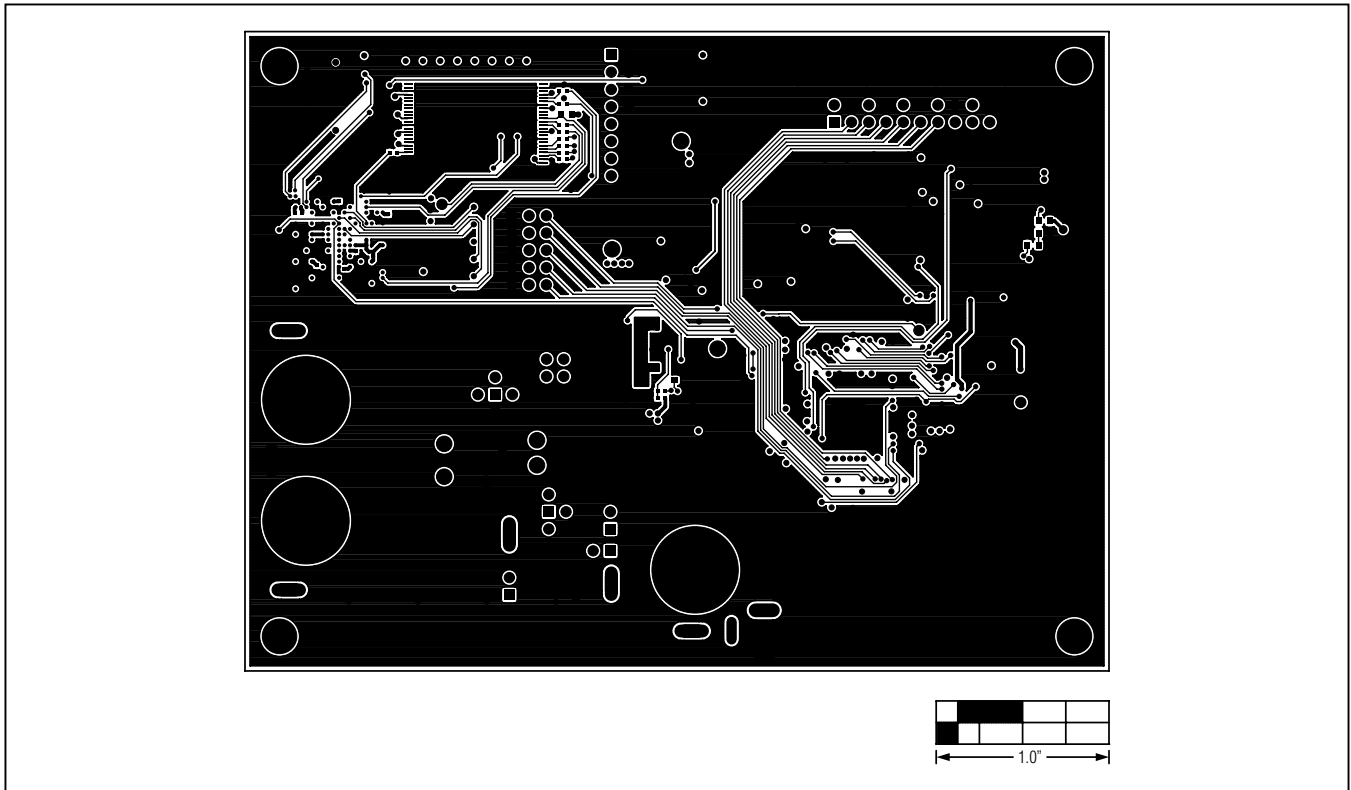

Figure 7. MAX98356 EV Kit PCB Layout—Solder Side

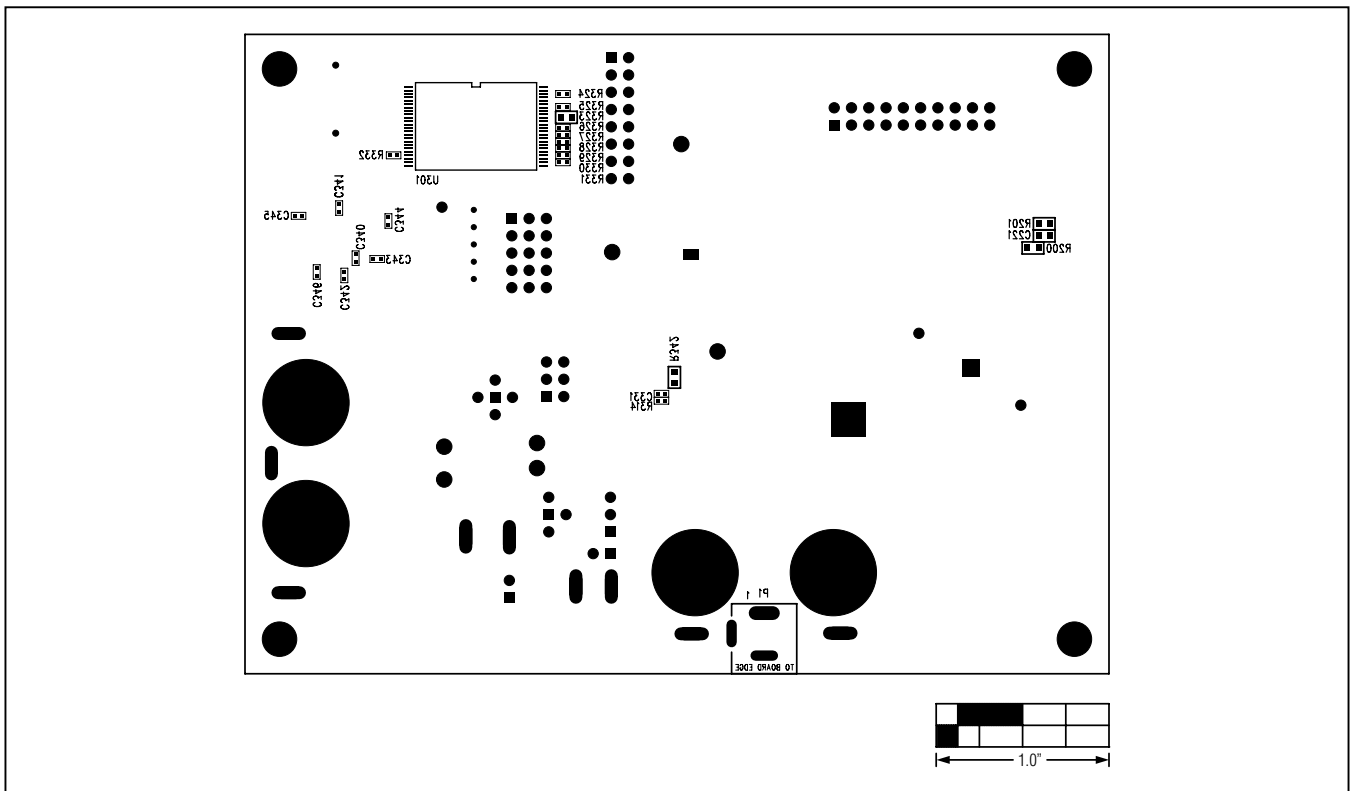

Figure 8. MAX98356 EV Kit Component Placement Guide—Solder Side

MAX98356 Evaluation Kit

Evaluates: MAX98356

Ordering Information

PART	TYPE
MAX98356EVKIT#	EV Kit

#Denotes RoHS compliant.

MAX98356 Evaluation Kit

Evaluates: MAX98356

Revision History

REVISION NUMBER	REVISION DATE	DESCRIPTION	PAGES CHANGED
0	7/12	Initial release	—



Maxim Integrated cannot assume responsibility for use of any circuitry other than circuitry entirely embodied in a Maxim Integrated product. No circuit patent licenses are implied. Maxim Integrated reserves the right to change the circuitry and specifications without notice at any time. The parametric values (min and max limits) shown in the Electrical Characteristics table are guaranteed. Other parametric values quoted in this data sheet are provided for guidance.

Maxim Integrated 160 Rio Robles, San Jose, CA 95134 USA 1-408-601-1000

20