



IN40-E0101K

IN4000 Direct

NON-CONTACT SAFETY SWITCHES

SICK
Sensor Intelligence.



Ordering information

Type	Part no.
IN40-E0101K	6027388

The devices conform to Category 3 as well as PFH_D 1.0×10^{-8} . Please check whether the device meets the safety requirements of your application as a result. If you have any questions, please consult your sales organization.

Other models and accessories → www.sick.com/IN4000_Direct



Detailed technical data

Features

Sensor principle	Inductive
Number of safe outputs	2
Switching delay from state change	Max. 50 ms ¹⁾
Enable zone	10 mm ... 15 mm ²⁾
Safe switch off distance S_{ar}	30 mm ²⁾
Actuation directions	5
Active sensor surfaces	1
Monitoring time minimum dwell time	≥ 0.2 s

¹⁾ During this time the output is switched off (Logical "0"), see response range.

²⁾ Dependent on material. The indicated values refer to steel ST37.

Safety-related parameters

Safety integrity level	SIL3 (IEC 61508), SILCL3 (EN 62061)
Category	Category 3 (EN ISO 13849)
Performance level	PL e (EN ISO 13849)
PFH_D (mean probability of a dangerous failure per hour)	1.0×10^{-8} (EN ISO 13849)
T_M (mission time)	10 years (EN ISO 13849) ¹⁾ 20 years (EN ISO 13849) ²⁾
Type	Type 3 (EN ISO 14119)
Actuator coding level	Uncoded (EN ISO 14119)
Classification in compliance with IEC/EN 60947-5-3	PDF-M

¹⁾ At -25 °C ... +70 °C and 5 % ... 95 % relative air humidity.

²⁾ At +10 °C ... +40 °C and 5 % ... 70 % relative air humidity.

Functions

Safe series connection	With Flexi Loop (with diagnostics)
-------------------------------	------------------------------------

Interfaces

Connection type	Plug connector, M12, 4-pin
------------------------	----------------------------

Power indication	✓
Status display	✓

Electrical data

Protection class	III (EN 50178)
Supply voltage V_s	24 V DC (19.2 V DC ... 30 V DC)
Power consumption	15 mA
Type of output	Semiconductor (OSSD)

Mechanical data

Design	Rectangular
Weight	0.22 kg
Material	
	Housing Zinc die cast (housing), PPE (cover)
Installation type	Non-flush

Ambient data

Enclosure rating	IP67 (IEC 60529)
Ambient operating temperature	-25 °C ... +70 °C
Storage temperature	-25 °C ... +70 °C
Vibration resistance	10 Hz ... 55 Hz, 1 mm (EN 60947-5-3)
Shock resistance	30 g, 11 ms (EN 60947-5-3)

Classifications

ECl@ss 5.0	27272401
ECl@ss 5.1.4	27272401
ECl@ss 6.0	27272401
ECl@ss 6.2	27272401
ECl@ss 7.0	27272401
ECl@ss 8.0	27272401
ECl@ss 8.1	27272401
ECl@ss 9.0	27272401
ETIM 5.0	EC001818
ETIM 6.0	EC001818
UNSPSC 16.0901	39122205

Dimensional drawing (Dimensions in mm (inch))

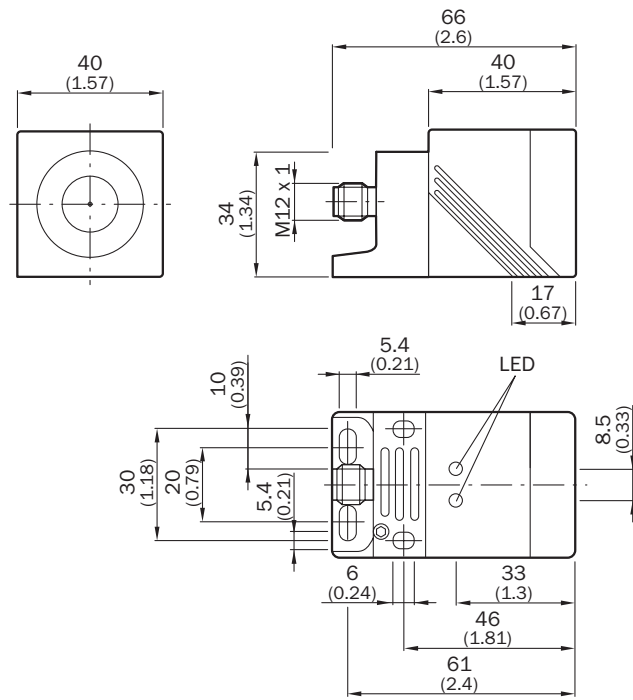

Response range

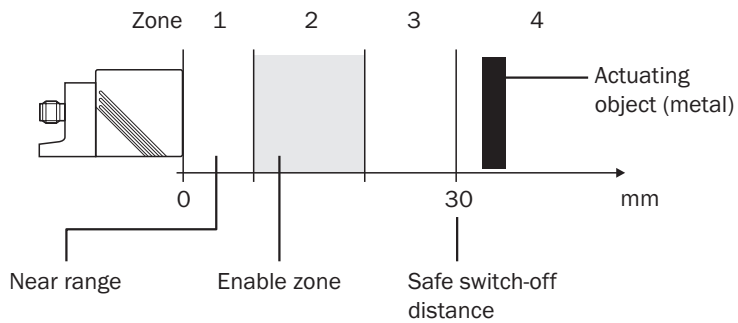

Connection diagram

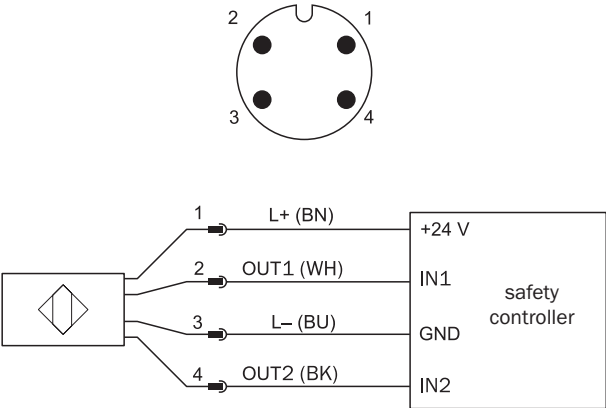

SICK AT A GLANCE

SICK is one of the leading manufacturers of intelligent sensors and sensor solutions for industrial applications. A unique range of products and services creates the perfect basis for controlling processes securely and efficiently, protecting individuals from accidents and preventing damage to the environment.

We have extensive experience in a wide range of industries and understand their processes and requirements. With intelligent sensors, we can deliver exactly what our customers need. In application centers in Europe, Asia and North America, system solutions are tested and optimized in accordance with customer specifications. All this makes us a reliable supplier and development partner.

Comprehensive services complete our offering: SICK LifeTime Services provide support throughout the machine life cycle and ensure safety and productivity.

For us, that is “Sensor Intelligence.”

WORLDWIDE PRESENCE:

Contacts and other locations –www.sick.com