

# Control Catalogue

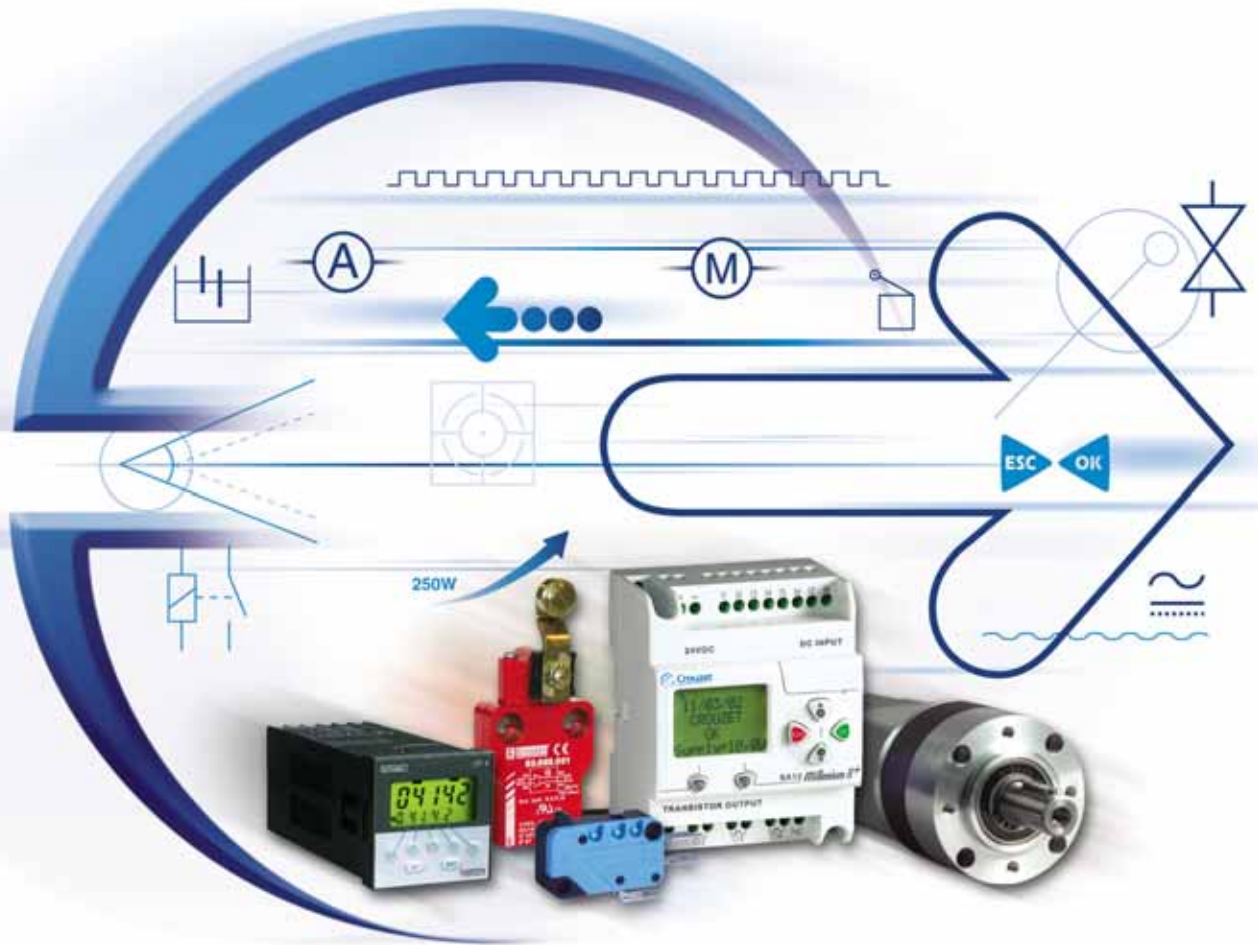

# The **specialist** brand which does **more for you**



**Sensors**  
sensors

**Control**  
control

**Motors**  
motors

Our in-depth knowledge of your business combined with our unrivalled expertise ensure that you benefit from an innovative range of customised products.

# Control **Contents**

<b>Crouzet, the Control specialist</b> .....	<b>04</b>
<b>How to order</b> .....	<b>06</b>
<b>The Crouzet offer</b> .....	<b>07</b>



Logic controllers .....

1



DIN rail mounted timers .....

2



Panel mounted timers .....

3



Control relays .....

4



Solid state relays .....

5



Solid state I/O modules .....

6



Temperature controllers .....

7



Counters and ratemeters .....

8



Cam timers .....

9



Machine safety .....

10



Micro-PLCs .....

11

Index by part number .....	<b>316</b>
General conditions of sale .....	<b>327</b>

# A brand **which sets the standard**

## An **acknowledged** specialist

With **30 years' experience and extensive technical and industrial expertise**, Crouzet is a key player in the **Control** market. Already world leader in time management functions and management of physical values, Crouzet is determined **to keep forging ahead**. It is not by chance that we have won the confidence of many manufacturing companies. **Confidence which Crouzet's workforce strive to maintain and develop on a daily basis.**



## A **technological** advance

From pure Research and Development to simply improving a standard product, our policy of constant re-evaluation means that we can offer **customised products** without ever ceasing to innovate: the Millennium II<sup>+</sup> logic controller is a perfect illustration of this approach.

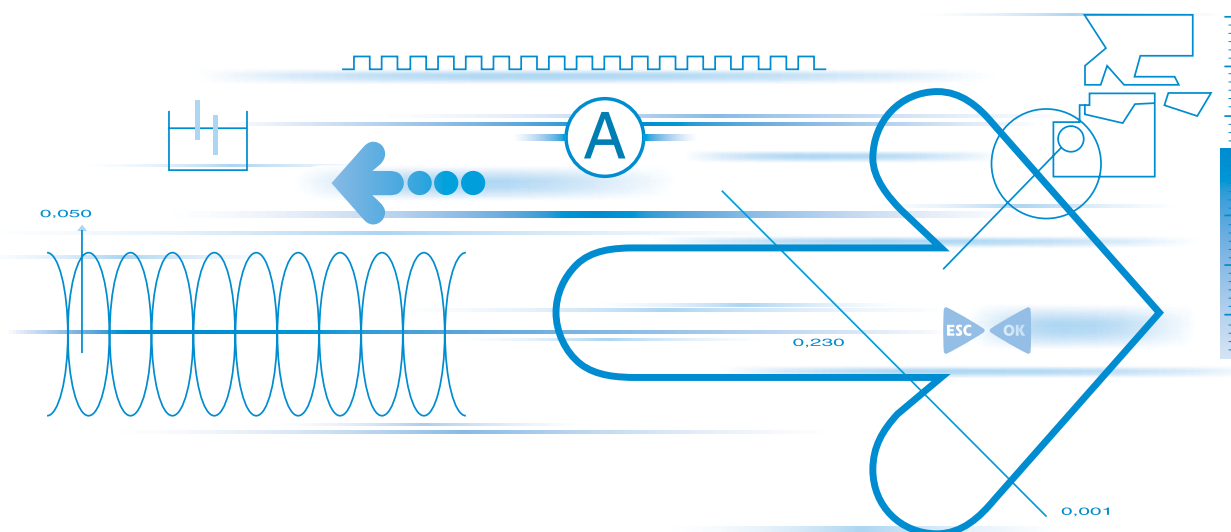

# A brand **which stands out from the crowd**

Crouzet is able to approach each project as a **true specialist**, going beyond a simple product response to offer you a complete solution. Our extensive range of unique products and unmatched expertise make Crouzet **one of the major players in the field of Control.**



## **Our offer hinges on 3 specialities:**

→ **Time management**

→ **Management of physical and electrical values**

→ **Counting**

## Skill and **proximity**



In response to the growing need for customisation, from pre-design through to maintenance, **our Product adaptation centre** can offer you expert advice on how products can be adapted or combined, and their environments modified accordingly: **product integration is guaranteed.**

Our distributors and specialist integrators are trained to guide you in finding the best solution, offering you a **hands-on approach at local level.**

Our responsive team of sales engineers and our technical and logistics departments are ready to work with you **in developing and industrialising your products.**

## An international organisation dedicated **to improving your efficiency**

Because you have diverse requirements, our solutions are designed to **adapt to all your needs**, in terms of technology, standards, timescales and budget.

By combining the skills of our engineers and sales managers, we can offer you **the best possible response time.**

Our priority is to satisfy your expectations to the fullest degree, and work closely with you throughout your project.



**Customer Call Center**

See back page for details of your local Crouzet office

## Special products, adaptations, additional information

Let's work together to find a customised solution

[www.crouzet.com](http://www.crouzet.com)



RESULTAT DE VOTRE RECHERCHE

88 826 105

- Fonction: programmation initiale par blocs fonction (PBC) en langage (SFC)
- Fonction: temporisation, comptage, régulation
- Fonction: maître: programmation initiale, programmation à cartes, contacts
- Entrées totales: 16 entrées, analogiques et numériques
- Sorties: 8 sorties, analogiques ou PWM
- Indicateur: affichage LCD à cristaux liquides
- Protection du programme par mot de passe
- Montage: programmeur solidaire
- Paramétrable en face avant

Dimension	Code
DC / 24 → 240 V AC	88 826 105
V DC / 24 → 240 V AC	88 826 115
V DC / 24 → 240 V AC	88 826 125
C / 24 → 240 V AC	88 826 135
240 V	

## Standard products

Give the reference in white.

## Standard products, not in stock

Give the reference in black and the additional characteristics

Dimension	Code
DC / 24 → 240 V AC	88 826 105
V DC / 24 → 240 V AC	88 826 115
DC / 24 → 240 V AC	88 826 125
24 → 240 V	88 826 135

### Warning:

The technical information in this catalogue is given for information only and does not constitute a contractual obligation. CROUZET Automatismes and its subsidiaries reserve the right to make any modifications without notice. It is essential to contact us for any special use/application of our products, and it is the responsibility of the purchaser to check, in particular using all appropriate tests, that the product used is suitable for the application. Our guarantee may under no circumstances be invoked, nor our responsibility sought for any application of our products such as, amongst others, modification, addition, use in combination with other electrical or electronic components, circuits or mounting systems, or any other inappropriate equipment or substance which has not been expressly approved by us prior to the finalisation of the sale.

# The **Crouzet** offer



## **Motors**

DC motors, brushless motors, Linear motors, Synchronous motors, Stepper motors, Asynchronous motors, Fans



## **Control**

Timers, Logic controller, Counters, Ratemeters, Control relays, Solid state relays, I/O modules, Temperature controllers, Micro-PLCs, Machine Safety, Control units for burners



## **Pneumatic**

Electro-pneumatic miniature control valves, Intrinsically safe miniature solenoid valves, Multi-fluid solenoid valves, Position detectors, Man / Machine Interface components, Pressure switches and amplifiers, Pneumatic logic components, Vacuum handling components



## **Sensors**

Limit switches, Microswitches, Inductive proximity sensors, Capacitive proximity sensors, Photoelectric sensors, Readout modules



## **Heavy duty control components**

Control and signalling components, Terminals, Displays, Selector switches, Consoles and control desks, Custom designed control units

# Senior **products**



[www.crouzet.com/OLC](http://www.crouzet.com/OLC)

**To meet your maintenance requirements, the senior products site contains a selection of products which no longer appear in this catalogue.**

To assist your search, this webspace will help you find the technical and price characteristics to enable you to procure these products.

And of course, your Crouzet contact is always on hand to help fill in the information required, or to suggest the optimum replacement solution.





# Logic controller

Logic controller

ESC

OK



Inputs	Outputs	Voltage	LCD display	Type	
8 PNP (4 analogue)	4 relays 8 A	12 VDC	With	SA 12	Page 16
			Without	EC 12	Page 18
		24 VDC	With	SA 12	Page 16
			Without	EC 12	Page 18
		100 to 240 VAC	With	SA 12	Page 16
			Without	EC 12	Page 18
	4 solid state digital/PWM 0.7 A	12 VDC	With	SA 12	Page 16
			Without	EC 12	Page 18
		24 VDC	With	SA 12	Page 16
			Without	EC 12	Page 18



8 NPN (2 analogue)	4 relays 8 A	24 VDC	With	SA 12	Page 16
			Without	EC 12	Page 18

12 PNP (8 analogue)	8 relays 8 A	12 VDC	With	SA 20	Page 16	
			Without	XT 20	Page 17	
		24 VDC	With	SA 20	Page 16	
			Without	EC 20	Page 18	
			100 to 240 VAC	With	SA 20	Page 16
				Without	EC 20	Page 18
		230 VAC	Without	EX 20	Page 17	
			24 VAC	With	SA 20	Page 16
		Without		EC 20	Page 18	
		12 VDC		With	SA 20	Page 16
				Without	EC 20	Page 18
		8 solid state digital/PWM 0.7 A	12 VDC	With	SA 20	Page 16
	Without			EC 20	Page 18	
	24 VDC		With	SA 20	Page 15	
			Without	EC 20	Page 18	
			With	SA 20	Page 15	
			Without	EC 20	Page 18	



12 NPN (4 analogue)	8 relays 8 A	24 VDC	With	SA 20	Page 16
				XT 20	Page 17
			Without	EC 20	Page 18
				EX 20	Page 17



## → Power supplies

230 VAC / 12 VDC	22 W	1.9 A	Page 22
230 VAC / 24 VDC	30 W	1.3 A	Page 22



1

## → Adjacent extensions

Inputs	Outputs	Voltage	Type	
4 PNP	2 relays 8 A	12 VDC	XC 01	Page 20
		24 VDC		
		100 to 240 VAC		
		24 VAC		
4 NPN	2 relays 8 A	24 VDC	XC 01	Page 20
24 VDC AS-i exchange unit			XC 02	Page 21
24 VDC MODBUS exchange unit			XC 03	Page 21



## → Local extensions

M2-M2 local link (2 modules)	XL 01	Page 20
4 Digital/PWM solid state outputs 0.7 A	XL 05	Page 20
2 relay outputs	XL 06	Page 20



XL 01 / XL 05

## → Starter kit

Inputs	Outputs	Voltage	LCD display	Type	
8 PNP	4 relays	24 VDC	With	KIT SA 12	Page 14
		100 to 240 VDC			
12 PNP	8 relays	24 VDC	With	KIT SA 20	Page 14
		100 to 240 VDC		KIT XT 20	
				KIT SA 20	
				KIT XT 20	



### Each kit consists of:

- a standard or expandable Millennium II (24 VDC or 100 to 240 VAC versions)
- a PC/Millennium II programming cable
- an interactive CD ROM including the software workshop, the tutorial, the application library and technical brochures.

## → Special starter kits

Type	Designation	
Level control KIT	Level control	Page 14

### Each kit consists of:

1 SA12 + programming software + programming cable + level sensor adaptor + 4 level sensors S7

Type	Designation	
Temperature control KIT	Heating, cooling and air conditioning	Page 14

### Each kit consists of:

1 SA12 + programming software + programming cable + PS24 power supply + temperature sensor + solid state relay with heatsink

## → Accessories

Programming cable USB	Page 23
MODEM KIT STN	Page 21
MODEM KIT GSM	Page 21
Waterproof adaptor EC12/SA12	Page 23
Waterproof adaptor SA20/XT20/EC20/EX20	Page 23
Waterproof adaptor SA20/XT20/EC20/EX20 + 1 extension module	Page 23
Temperature sensor (-40°C/+20°C)	Page 24
PWM/0-10V convertor	Page 23
4-20mA/0-10V convertor	Page 23
Programming software on CD ROM	Page 23
EEPROM memory module	Page 23
Programming cable	Page 23
Panel mounting adaptor EC12/SA12	Page 23
Panel mounting adaptor EC20/SA20/XT20/EX20	Page 23
Ambient temperature sensor (-10 to +40°C)	Page 24
Duct temperature sensor (-10 to +40°C)	Page 24
Outside temperature sensor (-10 to +40°C)	Page 24
Remote/Submersible temperature sensor (-10 to +150°C)	Page 24

# Millenium II +: general characteristics

- Starter kit**
- Blind**
- Temperature sensors**
- Special starter kits**
- Bare board**
- Power supply**
- Level detection**
- Local extensions**
- Accessories**
- Standard**
- Adjacent extensions**
- Communication modules**
- Expandable**

Insulation	7 MΩ
Safety class	0 industrial / II domestic casing
Earthing	None
Protection	IP20 / Terminal block IP40 IP00 for CN12 and CN20
Certifications	CE, UL, cUL
Conformity to standards	EN 60947-1 EN 60730-1 EN 60601-1
Programming method	Function blocks/SFC
Program size	128 blocks
Program memory	Flash EEPROM
Removable memory	EEPROM
Data memory	256 bits / 64 words backed up for 10 years
LCD display	Display with 4 lines of 12 characters
Real-time clock	Drift < 1 min/month at 25 °C with user-definable correction of drift Data retention : 10 years (lithium battery)
Storage temperature (°C)	-40 → +70
Operating temperature (°C)	-5 → +55
Relative humidity (no condensation)	90 → 95 %
Dimensions (l x h x w)	SA12-EC12 : 72 x 90 x 60 mm SA20-XT20 : 125 x 90 x 60 mm EC20-EX20 CN12 : 72 x 90 x 42 mm CN20 : 125 x 90 x 42 mm

## Electrical characteristics

<b>Power supply 100 - 240 V AC</b>	
Operating voltage	100 V AC → 240 V AC +10 % -15 % 50/60 Hz
Operating limits	85 V AC → 264 V AC
Immunity from micro power cuts	10 ms
Maximum inrush current	5 A
Max. absorbed power	SA12-EC12-CN12 : 6 VA SA20-EC20-CN20 : 6.5 VA XT20-EX20 : 8 VA

<b>Power supply 24 V AC</b>	
Operating voltage	24 V AC +10 % -15 % 50/60 Hz
Operating limits	20.4 V AC → 28.8 V AC
Immunity from micro power cuts	10 ms
Maximum inrush current	2.5 A
Max. absorbed power	SA12-EC12-CN12 : 6 VA SA20-EC20-CN20 : 6.5 VA XT20-EX20 : 8 VA

<b>Power supply 24 V DC</b>	
Operating voltage	24 V DC +20 % -15 %
Operating limits	20.4 V DC → 28.8 V DC
Immunity from micro power cuts	1 ms
Maximum inrush current	6 A
Max. absorbed power	SA12-EC12-CN12 : 3.5 W SA20-EC20-CN20 : 4 W XT20-EX20 : 5 W

<b>Power supply 12 V DC</b>	
Operating voltage	12 V DC +30% -15% +30% -11% for XT20 relay 88 950 065
Operating limits	10.2 V DC → 15.6 V DC 10.68 VDC → 15.6 V DC for XT 20 relay 88 950 065
Immunity from micro power cuts	1 ms
Maximum inrush current	6 A
Max. absorbed power	SA12-EC12-CN12 : 2.2 W SA20-EC20-CN20 : 4.5 W XT20-EX20 : 5.5 W

<b>100 - 240 V AC input</b>	
Input voltage (V AC)	100 - 240 (+10 % / -15 %)
Supply frequency range (Hz)	50/60 Hz
Input impedance (kΩ)	700
Pull-in voltage at logic state 1 (V AC)	≥ 80
Drop-out voltage at logic state 0 (V AC)	≤ 40
Response time	50
Status indicator	On LCD screen for SA12, SA20 and XT20

<b>24 V AC input</b>	
Input voltage (V AC)	24 (+10 % / -15 %)
Supply frequency range	50/60 Hz
Input impedance (kΩ)	4
Pull-in voltage at logic state 1 (V AC)	≥ 15
Drop-out voltage at logic state 0 (V AC)	≤ 5
Response time	50 ms
Status indicator	On LCD screen for SA12, SA20 and XT20

<b>Analogue input (24 V DC model only)</b>	
CN12-SA12-EC12	4 inputs from I5 to I8
CN20-SA20-EC20-XT20	8 inputs from I5 to I12
Measurement range	(0 → 10 V) or (0 → V power supply)
Resolution	8 bits
Conversion time	10 ms
Max input voltage	28.8 V DC
Input impedance (kΩ)	> 22
Accuracy	+/- 5 %
Drift Temperature	+/- 3 LSB
Potentiometer control	2.2 kΩ / 0.5 W

<b>24 V DC input</b>	
Current drain	24 (+20 % -15 %) V DC
Input current	3.2 mA / 5.5 mA max.
Input impedance	6.8 kΩ
Pull-in voltage at logic state 1	≥ 15 V DC
Drop-out voltage at logic state 0	≤ 5 V DC
Response time	10 ms
Galvanic isolation	No
Sensor type	Contact or 3-wire PNP or 3-wire NPN
Status indicator	On LCD screen for SA12, SA20 and XT20

<b>12 V DC input</b>	
Input voltage	12 (+30 % -15 %) V DC (except XT20R +30 % -11 %)
Input current	1.9 mA / 2.3 mA max.
Input impedance	6.45 kΩ
Pull-in voltage at logic state 1	≥ 8 V DC
Drop-out voltage at logic state 0	≤ 3 V DC
Response time	10 ms
Sensor type	Contact or PNP or 3-wire NPN
Galvanic isolation	No
Status indicator	On LCD screen for SA12, SA20 and XT20
<b>Analogue input (12 V DC model only)</b>	
CN12 - SA12 - EC12	4 inputs I5 to I8
CN20-SA20-EC20-XT20	8 inputs I5 to I8
Measurement range	0 → 10 V
Resolution	8 bits
Conversion time (ms)	10
Max input voltage	15.6 V DC
Input impedance (kΩ)	> 10 (14 typically)
Precision	± 5 %
Temp. dependent derating	± 3 LSB
Potentiometer control	2.2 kΩ / 0.5 W
<b>Relay output</b>	
Max. breaking voltage	250 V AC / 30 V DC
Breaking current	8 A
Service life	8 A / 250 V AC resistive (100 000 operations)
Minimum load	10 mA to 5 V DC
Response time	10 ms
Status indicator	On LCD screen for SA12, SA20 and XT20
<b>TOR / PWM solid state output</b>	
PWM solid state output	SA12-EC12-CN12 : O1 to O4 SA20-XT20-EC20-CN20 : O1 to O6
Breaking current	5-28.8 V DC
Breaking voltage	0.7 A / 5-28.8 V DC
Min. load	1 mA
Maximum inductive load	0.7 A
Maximum incandescent load	0.1 A
Leakage	0.1 mA / 24 V DC
Response time	1 ms
Insulation	No
PWM frequency	120 Hz to 1920 Hz (user-definable)
PWM cyclic ratio	0 to 100 % (256 steps)
PWM precision at 120 Hz	< 5 % (from 15 % to 85 %) load at 10 mA
PWM precision at 500 Hz	< 10 % (from 20 % to 80 %) load at 10 mA
Status indicator	On LCD screen for SA12, SA20 and XT20

# Millenium II +

## → Starter kit

- Discover the benefits of Millenium II+
- Each kit includes :
  - a standard or expandable Millenium II+
  - a PC/Millenium programming cable
  - an interactive CD-Rom including the software workshop, tutorial, application library and technical brochures.



### Specifications

Type	Input	Output	Supply	Code
KIT SA 12	8	4 relays	24 V DC	88 950 070
	8	4 relays	100 - 240 V AC	88 950 071
Kit SA 20	12	8 relays	24 V DC	88 950 072
	12	8 relays	100 - 240 V AC	88 950 073
Kit XT 20	12	8 relays	24 V DC	88 950 074
	12	8 relays	100 - 240 V AC	88 950 075

## → Special starter kits

- Special Millenium II kits with all the extras needed for your application
- Each kit includes :
  - a standard or expandable Millenium II+
  - a PC/Millenium programming cable
  - an interactive CD-ROM including the software workshop, tutorial, application library and technical brochures.



### Specifications

Type	Designation	Supply	Code
Level control KIT	Level control	24 V AC	88 950 076
Temperature control KIT	Heating, cooling and air conditioning	24 V DC	88 950 077

# Millenium II +

## → Level detection

- Intuitive programming via function block (FBD) or grafcet (SFC)
- Function : timing, counting, etc
- Application-specific functions : rotation, cam timers, calculation, etc
- Discrete, analogue or potentiometer inputs
- Relay, solid state or PWM outputs
- Backlit LCD display
- Program password protection
- Integral calendar and clock
- User-definable from the front panel
- Non-expandable



### Specifications

Type	Input	Output	Supply	Code
SA 12 + level sensor adaptor	8	4 relays	24 V AC	88 950 813

### Dimensions

SA 12

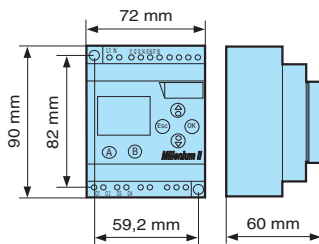

Level sensor adaptor

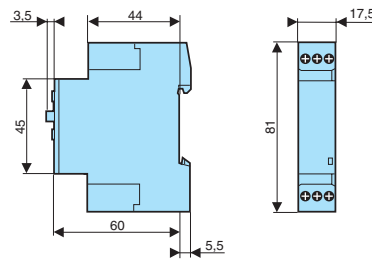

# Millenium II +

## → Standard

- Intuitive programming via function block (FBD) or grafcet (SFC)
- Function : timing, counting, etc
- Application-specific functions : rotation, cam timers, calculation, etc
- Discrete, analogue or potentiometer inputs
- Relay, solid state or PWM outputs
- Backlit LCD display
- Program password protection
- Integral calendar and clock
- User-definable from the front panel
- Non-expandable



### Specifications

Type	Input	Output	Supply	Code
SA 12	8 PNP	4 relays	24 VDC	88 950 041
	8	4 relays	100 - 240 VAC	88 950 043
	8	4 relays	24 VAC	88 950 044
	8 PNP	4 solid state	24 VDC	88 950 042
	8 PNP	4 relays	12 V DC	88 950 045
	8 PNP	4 solid state	12 V DC	88 950 046
	8 NPN	4 relays	24 VDC	88 950 049
	SA 20	12 PNP	8 relays	24 VDC
12		8 relays	100 - 240 VAC	88 950 053
12		8 relays	24 VAC	88 950 054
12 PNP		8 solid state	24 VDC	88 950 052
12 PNP		8 relays	12 V DC	88 950 055
12 PNP		8 solid state	12 V DC	88 950 056
12 NPN		8 relays	24 VDC	88 950 059

### Dimensions

SA 12

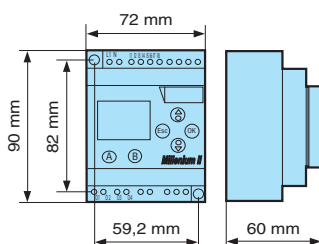

SA 20

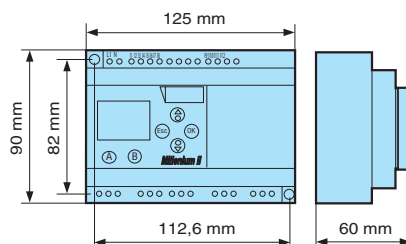

### General characteristics

see page 23



# Millenium II +

## → Expandable

- Expandable : communication, inputs/outputs, etc
- Intuitive programming via function block (FBD) or grafcet (SFC)
- Function : timing, counting, etc
- Application-specific functions : rotation, cam timers, calculation, etc
- Discrete, analogue or potentiometer inputs
- Relay, solid state or PWM outputs
- Backlit LCD display
- Program password protection
- Integral calender and clock
- User-definable from the front panel
- Can take an XC adjacent extension and an XL local extension



### Specifications

Type	Input	Output	Supply	Code
XT 20	12 PNP	8 relays	24 VDC	88 950 061
	12 PNP	8 relays	100 - 240 VAC	88 950 063
	12 PNP	8 relays	24 VAC	88 950 064
	12 PNP	8 solid state	24 VDC	88 950 062
	12 PNP	8 relays	12 V DC	88 950 065
	12 PNP	8 solid state	12 V DC	88 950 066
	12 NPN	8 relays	24 VDC	88 950 069
	EX 20	12 PNP	8 relays	24 V DC
12		8 relays	100 - 240 V AC	88 950 833
12		8 relays	24 V AC	88 950 834
12 PNP		8 solid state	24 V DC	88 950 832
12 NPN		8 relays	24 V DC	88 950 839

### Dimensions

XT 20

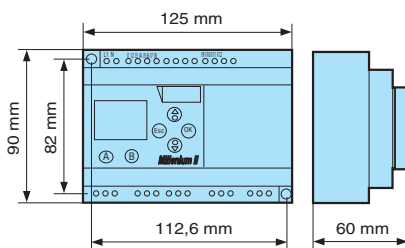

EX 20

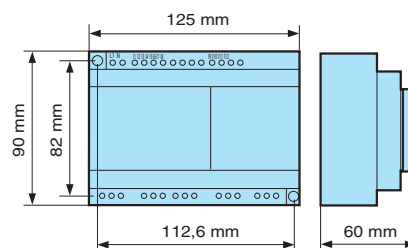

### General characteristics

see page 23

To order, see page 6

For more information [www.crouzet.com](http://www.crouzet.com)

# Millenium II +

## → Blind

- No display or parameter-setting buttons
- Intuitive programming via function block (FBD) or grafcet (SFC)
- Function : timing, counting, etc
- Application-specific functions : rotation, cam timers, calculation, etc
- Discrete, analogue or potentiometer inputs
- Relay, solid state or PWM outputs
- Program protected by a password
- Integral calendar and clock



### Specifications

Type	Input	Output	Supply	Code
EC12	8 PNP	4 relays	24 VDC	88 950 021
	8	4 relays	100 - 240 VAC	88 950 023
	8	4 relays	24 VAC	88 950 024
	8 PNP	4 solid state	24 VDC	88 950 022
	8 PNP	4 relays	12 V DC	88 950 025
	8 PNP	4 solid state	12 V DC	88 950 026
	8 NPN	4 relays	24 VDC	88 950 029
EC 20	12 PNP	8 relays	24 VDC	88 950 031
	12	8 relays	100 - 240 VAC	88 950 033
	12	8 relays	24 VAC	88 950 034
	12 PNP	8 solid state	24 VDC	88 950 032
	12 PNP	8 relays	12 V DC	88 950 035
	12 PNP	8 solid state	12 V DC	88 950 036
	12 NPN	8 relays	24 VDC	88 950 039

### Dimensions

EC 12

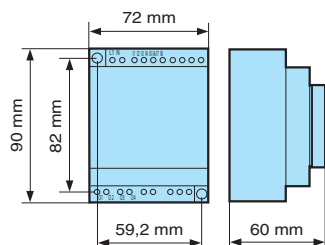

EC 20

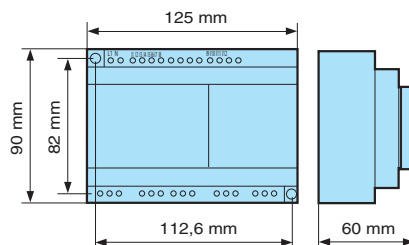

### General characteristics

see page 23

# Millenium II +

## → Bare board

- For mass-production applications
- Intuitive programming via function block (FBD) or grafcet (SFC)
- Function : timing, counting, etc
- Application-specific functions : rotation, cam timers, calculation, etc
- Discrete, analogue or potentiometer inputs
- Relay, solid state or PWM outputs
- Program protected by password
- Integral calendar and clock

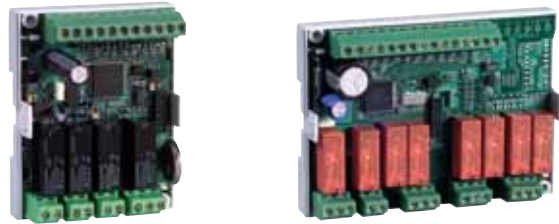

### Specifications

Type	Input	Output	Supply	Code	
CN 12	8 PNP	4 relays	24 V DC	88 950 001	
	8	4 relays	100 - 240 V AC	88 950 003	
	8	4 relays	24 V AC	88 950 004	
	8 PNP	4 solid state	24 V DC	88 950 002	
	8 PNP	4 relays	12 V DC	88 950 005	
	8 PNP	4 solid state	12 V DC	88 950 006	
	8 NPN	4 relays	24 V DC	88 950 009	
	CN 20	12 PNP	8 relays	24 V DC	88 950 011
		12	8 relays	100 - 240 V AC	88 950 013
12		8 relays	24 V AC	88 950 014	
12 PNP		8 solid state	24 V DC	88 950 012	
12 PNP		8 relays	12 V DC	88 950 015	
12 PNP		8 solid state	12 V DC	88 950 016	
12 NPN		8 relays	24 V DC	88 950 019	

### Dimensions

CN 12

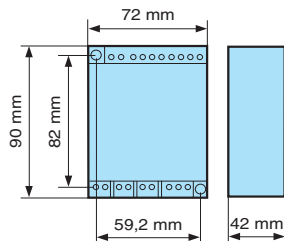

CN 20

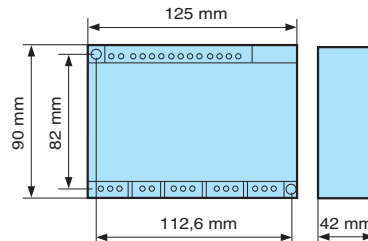

### General characteristics

see page 23

# Millenium II +

## → Local extensions

- For XT 20 only (1 local extension per module)
- Millenium - Millenium local link
- Doubles the hardware and software capacities
- Transparent communication between two XT 20 units
- Max. distance between two XT 20 units : 10 metres
- Cable type : screened twisted pair



### Specifications

Type	Designation	Supply	Code
XL 01	M2 - M2 local link (2 modules)	universal	88 950 200
XL 05	4 solid state outputs	universal	88 950 204
XL 06	2 relay outputs	100 → 240 V AC	88 950 810

## → Adjacent extensions

- For XT 20 only (one adjacent extension per module)
- 4 or 6 additional inputs/outputs



### Specifications

Type	Designation	Supply	Code
XC 01	4 inputs PNP 2 relay outputs	24 V DC	88 950 210
	4 inputs relay outputs	24 V AC	88 950 211
	4 inputs 2 relay outputs	100 - 240 V AC	88 950 212
	4 inputs 2 relay outputs	12 V DC	88 950 215
	4 inputs NPN 2 relay outputs	24 V DC	88 950 219

### Dimensions

XC 01

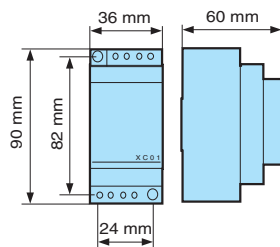

# Millenium II +

## → Communication modules

- For XT 20 only (one adjacent extension per module)
- Communication using MODBUS or AS-i protocol (Slave module)



### Specifications

Type	Designation	Supply	Code
XC 02	AS-i communication module 24 V DC	24 V DC	88 950 213
XC 03	MODBUS communication module 24 V DC	24 V DC	88 950 214
Modems	RTC		88 950 106
	GSM		88 950 107

### Dimensions

xc02/xc03

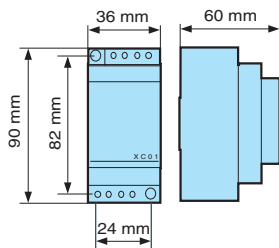

modem

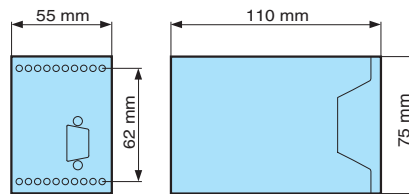

# Modular power supply

## → Power supply

- The output voltage can be adjusted from 100 to 120 % with a potentiometer in order to compensate for possible voltage drops.
- Output voltage existence is indicated by a continuously lit LED. A flashing LED indicates an autoprotection mode.
- Regulated, power surge and short circuit safe, the new switching power supplies easily fit into control panels.



### Specifications

Type	Voltage	Nominal power	Code
PS	12 V DC	22 W	88 950 300
	24 V DC	30 W	88 950 301

### General characteristics

Input voltage	100 → 240 V AC single phase
Output voltage	88 950 300 : 12 V DC 88 950 301 : 24 V DC ajustable de 100 à 120 %
Nominal power	88 950 300 : 22W 88 950 301 : 30W
Technology	Electronic with primary decoupling
Short-circuit protection	•
Overload protection	•
Reset after overload	automatic
Status indication	Output LED
Mounting	DIN rail EN 50022
Conformity to standards	EN 50081-1 EN 50082-1 CEI 61000-8-2 CEI 950
Certifications	CE, UL-CSA, TÜV, CTick

### Dimensions

PS

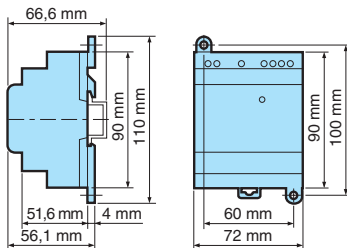

## Accessories

### → Front panel adaptors



#### Specifications

Type	Designation	Code
Front panel adaptor	Front panel adaptor for EC12-SA12	89 750 103
	Front panel adaptor for EC20-SA20-XT20-EX20	89 750 109
Waterproof panel	Waterproof panel adaptor for SA12-EC12	89 750 160
	Waterproof panel adaptor for SA20-XT20-EC20-EX20	89 750 161
	Waterproof panel adaptor for SA20-XT20-EC20-EX20 + 1 extension	89 750 162

### → Interconnection cables



#### Specifications

Type	Designation	Code
Programming cables	Programming cable 9-pin D connector	88 950 102
	Programming cable USB	88 950 105
Modem cable		88 950 111

### → Programming tools



#### Specifications

Type	Designation	Code
Software	Programming software on CD ROM	88 950 100
	Modem installation software	88 950 113
Module	EEPROM memory module	88 950 101

### → Convertors



#### Specifications

Type	Designation	Input	Output	Code
Convertor 0-20 mA / 0-10 V	Input module 0-20 mA / 0-10 V	4	4	88 950 108
Convertor PWM / 0-10V	Output module PWM 0-10V	1	1	88 950 112

To order, see page 6

For more information [www.crouzet.com](http://www.crouzet.com)

# Temperature sensors

## → Temperature sensors

- Built-in converter : 0-10 V DC output
- Applications : Industrial and domestic



### Specifications

Type	Range	Accuracy	Protection casing	Protection probe	Code
Zone	-10 → +40 °C	-0.2 °C +1.2 °C	IP30		89 750 150
Ventilation duct	-10 → +40 °C	-0.2 °C +1.9 °C	IP65	IP30	89 750 151
Outdoor	-10 → +40 °C	-0.2 °C +1.2 °C	IP65		89 750 152
Remote/submersible probe	-10 → +150 °C	-0.2 °C +1.2 °C	IP65	IP67	89 750 153
Outdoor	-40 → +20 °C	-0.2 °C +1.9 °C	IP65	IP67	89 750 155

### Accessories

Accessories	Operating temperature (°C)	Operating pressure (bar)	Code
Copper protective sleeve for 89 750 153	-20 → +100	10	89 750 146
Stainless steel (316) protective sleeve for 89 750 153	-20 → +400	16	89 750 147
Heat transfer compound	-	-	18 372 112

### General characteristics

Supply voltage	24 V DC (±10 %)
Output	0 → 10 V DC
Temperature coefficients Derating	0.01 % / °C of full scale
Temperature coefficients Offset	1.5 mV / °C
Ambient temperature (°C)	-10 → +60
Ambient humidity	5 → 95 % RH
Material housing	Self-extinguishing



## Dimensions

89 750 150

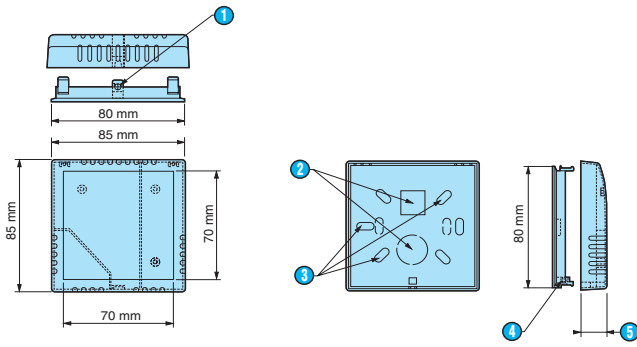

- 1 Ø3 mm for screw M3 x 8
- 2 Cut-outs
- 3 Fixing holes
- 4 Bolt hole M3
- 5 Maximum thickness 26 mm

89 750 152

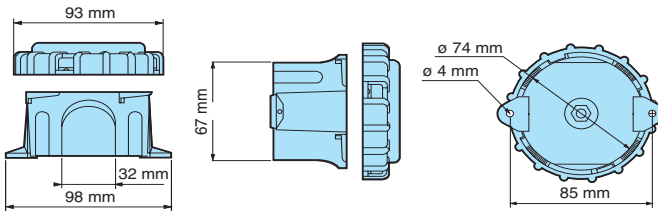

89 750 151

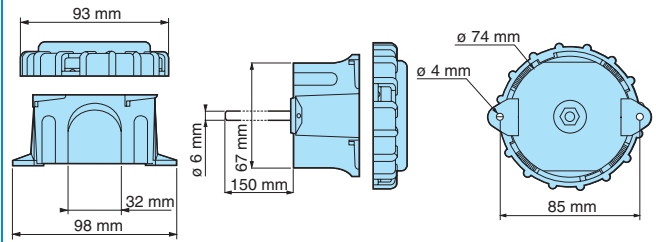

89 750 153 and 89 750 155

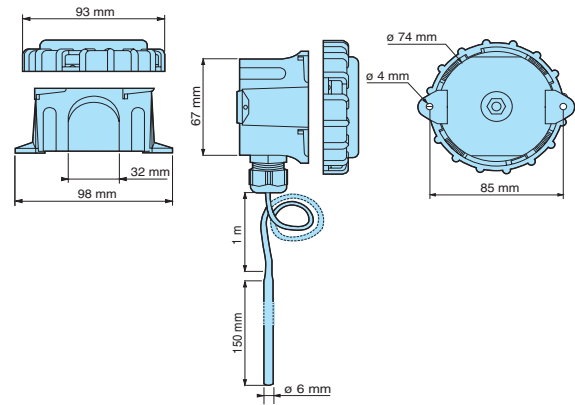

Accessories for 89 750 153 and 89 750 155

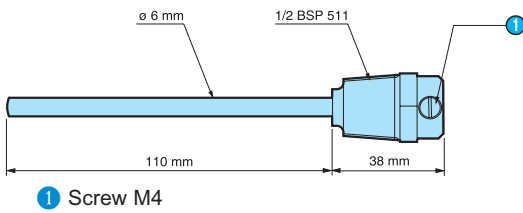

- 1 Screw M4



# DIN rail-mounted Timers



Function	Casing	Output	Voltage	Connection	Designation	Rated current	
• Delay on energisation (A)	17.5 mm	Solid state	24 to 240 VAC/DC	Screw terminals	MAS5	0.7 A	Page 36
	35 mm	2 relays	24 VDC 24 to 240 VAC	8-pin	OA2R1	8 A	Page 42
• Timing on impulse (one shot) (B)	17.5 mm	1 relay	24 VDC 24 to 240 VAC	Screw terminals	MBR1	8 A	Page 36
	22.5 mm				TBR1		Page 38
• Timing after impulse Off-delay timer (C)	17.5 mm	1 relay	24 VDC 24 to 240 VAC	Screw terminals	MCR1	8 A	Page 36
	22.5 mm				TCR1		Page 38
	Plug-in			2 relays	8-pin		OCR1
		11-pin			PC2R1		
• Timing on energisation (H)	17.5 mm	Solid state	24 to 240 VAC	Screw terminals	MHS2	0.7 A	Page 36
• Delay on de-energisation True delay off (K)	22.5 mm	2 relays	24 VDC 24 to 240 VAC	Screw terminals	TK2R1	8 A	Page 38
• Starting "Star-Delta" (Q)	22.5 mm	1 relay	24 VDC 24 to 240 VAC	Screw terminals	TQR1	8 A	Page 38
• Delay on energisation (A) • Delay on energisation with memory (At)	17.5 mm	1 relay	24 VDC 24 to 240 VAC	Screw terminals	MAR1	8 A	Page 36
	22.5 mm				TAR1		Page 38
					Plug-in		2 relays
	17.5 mm	1 relay		Screw terminals			
22.5 mm	1 relay	Screw terminals	THR1	Page 38			
• Cyclic timing Pause starting (L) • Cyclic timing Pulse starting (Li)	17.5 mm	Solid state	24 to 240 VAC	Screw terminals	MLS2	0.7 A	Page 36
	22.5 mm	1 relay	24 VDC 24 to 240 VAC		MLR1		8 A
				8-pin	OLR1	Page 42	
				11-pin	PL2R1		



MAR 1



TAR 1



OLR 1

MONO-FUNCTION

2

## CHRONOS 2 DIN rail mounted timers

Function	Casing	Output	Voltage	Connection	Designation	Rated current									
<ul style="list-style-type: none"> <li>• Delay on energisation (A)</li> <li>• Delay on energisation with memory (At)</li> <li>• Timing on impulse (one shot) Shaping (B)</li> <li>• Timing after impulse Off-delay timer (C)</li> <li>• Timing on energisation (H)</li> <li>• Timing on energisation with memory (Ht)</li> <li>• Cyclic timing Pause start (D)</li> <li>• Cyclic timing Pulse start (Di)</li> <li>• Pulse output (adjustable) (Bw)</li> <li>• Timing after closing and opening of control contact (Ac)</li> </ul>	17.5 mm	1 relay	12 VAC/DC	Screw terminals	MUR4	8 A	Page 36								
			12 to 240 VAC/DC		MUR3										
			24 VDC 24 to 240 VAC	Spring terminals	MURc3										
		22.5 mm	1 relay	24 to 240 VAC	Screw terminals	MUR1		0.7 A	Page 38						
				12 VAC/DC		TUR4									
				12 to 240 VAC/DC	Spring terminals	TUR3									
	2 relays		24 VDC 24 to 240 VAC	Screw terminals	TUR1	8 A	Page 42								
			12 VAC/DC		TU2R4										
			24 VDC 24 to 240 VAC		TU2R1										
	Plug-in	1 relay	12 to 230 VAC	8-pin	TU2R3	8 A		Page 42							
			12 VAC/DC		OUR4										
			12 to 240 VAC/DC		OUR3										
		2 relays	24 VDC 24 to 240 VAC	11-pin	OUR1	8 A	Page 42								
			12 VAC/DC		PU2R1										
			12 to 240 VAC/DC		PU2R4										
	<ul style="list-style-type: none"> <li>• Delay on energisation by switch (non resettable) (Ad)</li> <li>• Flashing single cycle by switch (non resettable) (Ah)</li> <li>• Safe-guard (N)</li> <li>• Delayed safe-guard (O)</li> <li>• Delayed fixed-length pulse (P)</li> <li>• Impulse counter (delay on) (Pt)</li> <li>• Impulse relay (TL)</li> <li>• Timed impulse relay (Tt)</li> <li>• Timing after pulse on control contact (W)</li> </ul>	17.5 mm	1 relay	24 VDC 24 to 240 VAC	Screw terminals	MXR1		8 A	Page 36						
						22.5 mm				2 relays	24 VDC 24 to 240 VAC	Screw terminals	TXR1	8 A	Page 38
													2 relays		



MURc3



TUR1



OUR1

Timing ranges 0.1 s to 100 hrs (generic to all CHRONOS 2)

## DIN rail mounted miniature timers

Function	Output	Voltage*	Connection	Designation	Rated current		
Delay on energisation (A)	2 relays	12 VDC	8-pin	RTMA 2	5 A	Page 46	
		24 VDC					
		24 VAC					
		110 VAC					
	4 relays	230 to 240 VAC	14-pin	RTMA 4	3 A		Page 46
		12 VDC					
		24 VDC					
		24 VAC					
4 relays	110 VAC	14-pin	RTMA 4	3 A	Page 46		
	230 to 240 VAC						



RTMA 4

Timing ranges 0.1 s to 100 hrs

\*48 VAC or VDC possible if an additional resistor is used

Function	Timing (to be specified when ordering)	Voltage	Connection	Designation	Solid state output	
A	60 min	12 VDC	Faston connectors 6.35 mm	SAS	0,7 A	Page 50
		24 VAC				
		48 VAC				
		110 VAC				
		220-240 VAC				
Ap	100 s	12 VDC	Faston connectors 6.35 mm	SAS P	0,7 A	Page 50
		24 VAC				
		48 VAC				
		110 VAC				
		220-240 VAC				
Ad	60 min	12 VDC	Faston connectors 6.35 mm	SAS D	0,7 A	Page 50
		24 VAC				
		48 VAC				
		110 VAC				
		220-240 VAC				
Ai	60 min	12 VDC	Faston connectors 6.35 mm	SAS I	0,7 A	Page 50
		24 VAC				
		48 VAC				
		110 VAC				
		220-240 VAC				
B	60 min	24 VAC	Faston connectors 6.35 mm	SBS	0,7 A	Page 52
		48 VAC				
		110 VAC				
		230 VAC				
Bp	100 s	24 VAC	Faston connectors 6.35 mm	SBS P	0,7 A	Page 52
		48 VAC				
		110 VAC				
		230 VAC				
Bd	60 min	24 VAC	Faston connectors 6.35 mm	SBS D	0,7 A	Page 52
		48 VAC				
		110 VAC				
		230 VAC				
C	60 min	24 VAC	Faston connectors 6.35 mm	SCS	0,7 A	Page 53
		48 VAC				
		110 VAC				
		230 VAC				
Cp	100 s	24 VAC	Faston connectors 6.35 mm	SCS P	0,7 A	Page 53
		48 VAC				
		110 VAC				
		230 VAC				
Cd	60 min	24 VAC	Faston connectors 6.35 mm	SCS D	0,7 A	Page 53
		48 VAC				
		110 VAC				
		230 VAC				
E	10 min	24 VAC	Faston connectors 6.35 mm	SDS B	0,7 A	Page 56
		48 VAC				
		110 VAC				
		230 VAC				
Ep	10 min	24 VAC	Faston connectors 6.35 mm	SDS BP	0,7 A	Page 56
		48 VAC				
		110 VAC				
		230 VAC				
Ed	10 min	24 VAC	Faston connectors 6.35 mm	SDS BD	0,7 A	Page 56
		48 VAC				
		110 VAC				
		230 VAC				

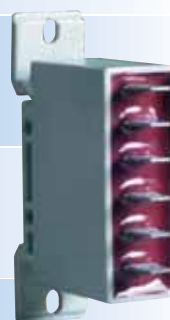

MONO-FUNCTION

2

MONO-FUNCTION

Function	Timing (to be specified when ordering)	Voltage	Connection	Designation	Solid state output	
E1	1 s	40 to 240 VAC	Faston connectors 6.35 mm	SDS 1A	0,7 A	Page 56
		10 to 50 VAC		SDS 2A		
E2	1 s	40 to 240 VAC	Faston connectors 6.35 mm	SHS 1B	0,7 A	Page 56
		10 to 50 VAC		SHS 2B		
H (2 wire)	60 min	24 VAC	Faston connectors 6.35 mm	SHS B	0,7 A	Page 54
		48 VAC				
		110 VAC				
		230 VAC				
Hp (2 wire)	100 s	24 VAC	Faston connectors 6.35 mm	SHS BP	0,7 A	Page 54
		48 VAC				
		110 VAC				
		230 VAC				
Hd (2 wire)	60 min	24 VAC	Faston connectors 6.35 mm	SHS BD	0,7 A	Page 54
		48 VAC				
		110 VAC				
		230 VAC				
Hi (4 wire)	60 min	24 VAC	Faston connectors 6.35 mm	SHI S	0,7 A	Page 54
		48 VAC				
		110 VAC				
		230 VAC				
H (3 wire)	100 s	24 VAC	Faston connectors 6.35 mm	SHS	0,7 A	Page 54
		48 VAC				
		110 VAC				
		230 VAC				
H (3 wire)	60 min	24 VAC	Faston connectors 6.35 mm	SHS P	0,7 A	Page 54
		48 VAC				
		110 VAC				
		230 VAC				
Hp (3 wire)	60 min	24 VAC	Faston connectors 6.35 mm	SHS D	0,7 A	Page 54
		48 VAC				
		110 VAC				
		230 VAC				
Prevention of compressor short-cycling (ACC1)	10 min	24 VAC	Faston connectors 6.35 mm	SAS X	0,7 A	Page 60
		48 VAC				
		110 VAC				
		230 VAC				
Prevention of compressor short-cycling (ACC2)	10 min	24 VAC	Faston connectors 6.35 mm	SAS C	0,7 A	Page 60
		48 VAC				
		110 VAC				
		230 VAC				
Prevention of compressor short-cycling (ACC3)	180 s 240 s 330 s	24 VAC	Faston connectors 6.35 mm	SAS CB	0,7 A	Page 60
		48 VAC				
		110 VAC				
		230 VAC				
Prevention of compressor short-cycling (La)	T on : 60 min T off : 60 min	24 VAC	Faston connectors 6.35 mm	SGS	0,7 A	Page 58
		48 VAC				
		110 VAC				
		230 VAC				
Prevention of compressor short-cycling (L)	T on : 60 min T off : 60 min	24 VAC	Faston connectors 6.35 mm	SGS I	0,7 A	Page 58
		48 VAC				
		110 VAC				
		230 VAC				
Prevention of compressor short-cycling (X)	T1 on : 60 min T2 off : 60 min	24 VAC	Cosses faston 6,35 mm	SFS	0,7 A	Page 59
		48 VAC				
		110 VAC				
		230 VAC				



## Heat exchanger defrost relay for air conditioning system

Function	Timing max.	Voltage	Connection	Designation	Output
Frost formation monitored by temperature probe Choice of defrosting time	90 min	90 to 260 VAC	Faston connectors 6.35 mm	NFR	1 relay

Page 62



## Electromechanical DIN rail mounted timers

Function	Output	Timing	Designation	Solid state output	Voltage	Connection
MULTI-FUNCTION	2-3-4 1 relay	6 s to 12 min	TOP 2000	5 A	24 VAC	Screw terminals
					42 to 48 VAC	
					110 to 127 VAC	
					220 to 240 VAC	
		6 min to 12 h			24 VAC	
					42 to 48 VAC	
					110 to 127 VAC	
					220 to 240 VAC	

Page 64



2



# Basic principles

## Timers

A timer is a control component which, after a preset time, energises an output contact. The start of a timing cycle, single or repetitive, is produced by timer energisation or by maintained or pulse control contacts with, as a result, a large number of potential functions. There are two types of presentation:

### → DIN rail mounted

Product designed for mounting within a control panel.

### → Panel-mounted

Product designed to be fitted on a panel in order to be accessible by the user.

There are two types of output:

**Timed contacts** dependent on the value of the set time.

**Instantaneous contacts** operating simultaneously with the energisation or de-energisation of the product in instantaneous fashion (excluding certain cases, for example: memory).

### → Note:

Electro-mechanical timers with automatic reset are fitted with:

- either a standard clutch : during timing, the electro-clutch is energised
  - or a reversed clutch : during timing the electro-clutch is de-energised.
- Timers with manual reset require "manual" intervention for the commencement of a new cycle which involves resetting the timing selector.

## Definitions

### → Minimum control contact time

This is the minimum pulse time required to effect timing control.

### → Reset time (or return)

This is the time required at the end of a cycle for resetting the timer to start a new cycle.

### → Accuracy

This is the maximum difference between the selected and the actual timing of the cycle chosen.

It is expressed as a percentage of the maximum value of the timing range considered within normal operating parameters.

### → Maximum operating current

This is the maximum uninterrupted current at which the timer may function permanently within normal operating parameters when the timer contact is closed.

### → Thermal intensity

Current limit in continuous duty for a circuit with the highest possible level of current which a previously closed contact circuit can tolerate at all times in specified conditions.

### → Contact rating

This is the value of the current that can be switched by a contact in certain specified conditions.

### Insulation to standard VDE 110 group C, IEC 255.5 and IEC 664

Spécifications pour le dimensionnement des lignes de fuite et distance dans l'air du matériel électrique.

### → Protection

To IEC 529: classification of the levels of protection obtained by casings, terminal

- against solid matter
- against liquids

### → Protection from voltage surge

This protection is designed to eliminate voltage peaks generated by the industrial environment. It is generally provided by a varistor, the capacity of which is expressed in joules.

Example:

2 joules = 5000V x 400 A x 1µs

For circuits with strong electrical interference (over 2 joules) the user should ensure adequate protection.

### → Electromagnetic compatibility

Electromagnetic compatibility tests measure the degree of immunity which a piece of equipment shows to various types of disturbance as defined in IEC standards.

## Controls

### → Quality control

Our products are quality controlled systematically during assembly and on completion. The overseeing of control checks in the workshop, the use of collected data and any resulting product assessments form the essential role of Quality Control. All our products undergo a final check, either 100% or on a selective basis according to French standard X 06-022, which provides for a classification of possible defects in three groups : critical, major, minor.

### → Note:

According to customer requirements and for certain product ranges which must meet particular requirements expressed in a specification, it is always possible to create or to modify a quality standard on the basis of a normal or special existing product and to vary the level of inspection. It can happen that the tolerance level is set at zero for certain parameters directly linked to the completion of a function for which total success must be assured: a defect is therefore fatal. Such specific requirements do, however, entail a significant increase in product costs.

# FUNCTIONS

U : Supply  
 R : Output or load relay  
 T : Timing  
 C (Y1) : Control contact  
 ∞ : indefinite

## → Function A : Delay on energisation

Single timing cycle which begins on energisation.

The output changes state after timing.

2 relays timed or  
 1 relay timed and 1 instantaneous

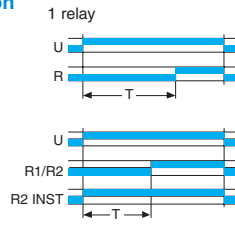

## → Function Ab : One-shot cycle

The output changes states at the end of the set time T1, for a period T2.

Both T1 and T2 independently adjustable.

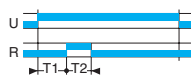

## → Function Ac : Timing after closing and opening of control contact

After energisation, closure of the control contact causes the timing period T to commence and output relay R (or the load) changes state at the end of this interval. When contact C (Y1) opens, relay R resets after a second timing period T.

2 relays timed or  
 1 relay timed and 1 instantaneous

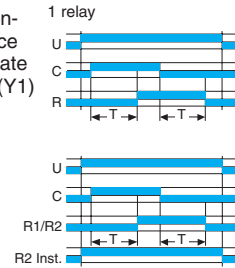

## → Function Ad : Delay on energisation by switch (not resettable)

After power-up, pressing or holding down the switch starts timing. At the end of timing, the output is energised. The output will be reset the next time the switch is pressed or held down.

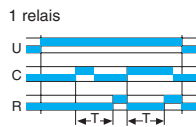

## → Function Ah : Flashing single cycle by switch (not resettable)

After power-up, pressing or holding down the switch starts timing. At the end of timing, the output is energised. At the end of this second timing, the output falls back to its initial value.

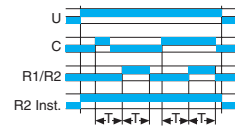

## → Function At : Timing on energisation with memory

Provides a cumulative time for contact opening.

The output changes states at the end of the set time.

2 relays timed or  
 1 relay timed and 1 instantaneous

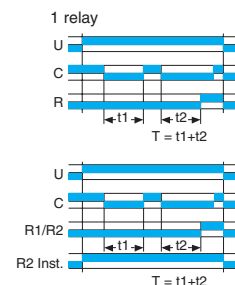

## → Function B : Timing on impulse one shot On pulse (with constant supply)

After energisation; a pulse (≥ 50 ms) or a maintained control contact will cause the output to change state which reverts to the rest position at the end of timing.

N.B. : this process enables shortening or lengthening of a signal.

2 relays timed or  
 1 relay timed and 1 instantaneous

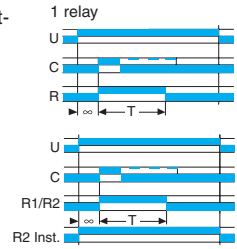

## → Function Bw : Pulse output (adjustable)

A output relay R (or the load) changes state, and remains in the changed-over state for the timing period, both when control contact C (Y1) closes and when it opens.

2 relays timed or  
 1 relay timed and 1 instantaneous

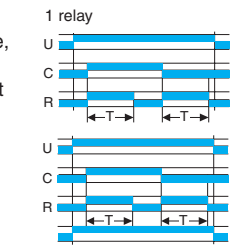

## → Function C : Timing after impulse Delay OFF (with constant supply)

After energisation, once the control contact is closed the output state changes.

Timing will only begin on the re-opening of this control contact (one shot).

Relay R returns to its initial position at the end of the timing period.

2 relays timed or  
 1 relay timed and 1 instantaneous

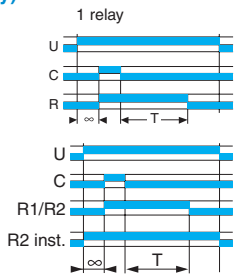

## → Function D ou Di : Flip-flop

Repetitive cycle which switches the output alternately between the rest and operating position for equal time bases.

T1 + T2 = T total

Function D: the cycle begins with the output in rest position. Pause start.

2 relays timed or  
 1 relay timed and 1 instantaneous

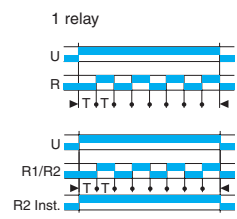

Function Di: the cycle begins with the output in the operating position. Pulse start.

2 relays timed or  
 1 relay timed and 1 instantaneous

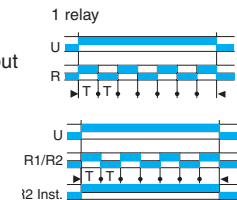

## → Function H : Timing on energisation Interval timer - one shot

On energisation, the output changes state, remains in that state for the duration of timing and resets at the end of the single cycle.

N.B. This is complementary to function A.

2 relays timed or  
 1 relay timed and 1 instantaneous

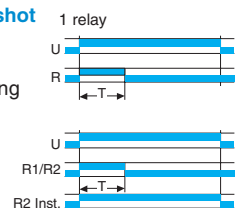

→ **Function Ht : Delay on energisation with memory**

Provides a cumulative time for contact opening. On energisation, the output changes state, remains in that state for the duration of timing and resets at the end of the single cycle.

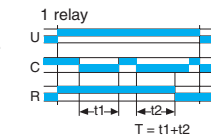

2 relays timed or  
1 relay timed and 1 instantaneous

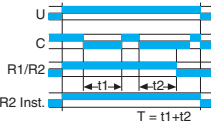

→ **Function K : Delay on de-energisation - True delay OFF**

On energisation, the output changes state. On de-energisation timing commences and the output only returns to the reset condition after timing.

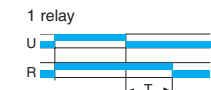

2 relays timed or  
1 relay timed and 1 instantaneous

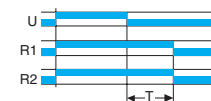

→ **Function L : Cyclic timing - Asymmetrical recycler**

Repetitive cycle comprising 2 independent adjustable time bases. Each time base corresponds alternately to a different output state.

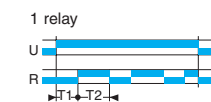

**N.B. :** The cycle starts with the output in the rest position.

2 relays timed or  
1 relay timed and 1 instantaneous

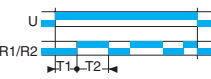

→ **Function Li : Cyclic timing - Asymmetrical recycler**

Repetitive cycle comprising 2 independent adjustable time bases. Each time base corresponds alternately to a different output state.

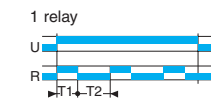

**N.B. :** The cycle starts with the output in the operating position.

2 relays timed or  
1 relay timed and 1 instantaneous

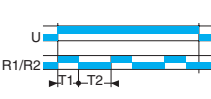

→ **Function N : "Safe-guard"**

At the first control pulse the output is energised. To complete the timing the interval between the two control pulses must be greater than the timing set.

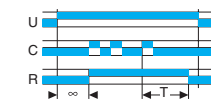

→ **Function O : "Delayed safe-guard"**

On energisation, a first timing sequence occurs and the output changes state. With the closing of the control contact, the output resets and the timing starts, with the output being activated after timing. For the timing to be completed, the interval between the closing of two control contacts must be greater than the timing set.

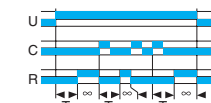

→ **Function P : Delayed fixed-length pulse**

Timing begins on energisation. At the end of the timing period output relay R (or the load) changes state for a period of approx. 500 milliseconds.

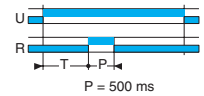

→ **Function Pt : Impulse counter (delay on)**

Calculates the total opening time of a contact. At the end of timing, the output is energised for approximately 500 ms.

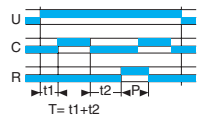

→ **Function Q : "Star-delta"**

At the end of timing, the output is not energised. It remains "open" (not conducting) and will only change state after the fixed time of Ti has elapsed. Dwell time selectable

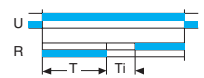

→ **Function T : Timing on energisation with memory**

**a - energisation by control signal**  
The timer sums the times for which the control contact is closed (C1). Reset is by the reset signal (C2) only.

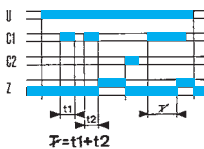

**b - energisation by supply voltage**  
The timer sums the times for which the supply voltage (U) is on. Reset is by the reset signal (C2) only

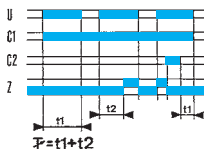

→ **Function T : Impulse relay**

After power-up, pressing or holding down the switch closes the relay. Pressing the switch a second time opens the relay.

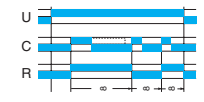

→ **Function Tt : Timed impulse relay**

After power-up, pressing or holding down the switch closes the relay and starts timing. The relay opens at the end of timing or when the switch is pressed a second time.

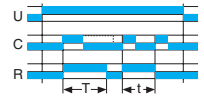

→ **Function W : Timing after pulse on control contact**

After energisation, if the control contact opens it causes output relay R (or the load) to change state and timing to start. At the end of the timing period, relay R resets to its original state.

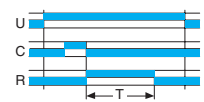

# Chronos 2 timers

## → 17.5 mm DIN rail mounting

- Relay or solid state output
- Multi-function or mono-function
- Multi-range
- Multi-voltage
- Screw or spring terminals
- LED status indicator (relay version)
- Option of connecting an external power supply to the control input
- 3-wire sensor control option



### Specifications

Type	Functions	Output	Nominal rating	Connections	Supply voltage	Code
MUR1	A - At - B - C - H - Ht - Di - D - Ac - Bw	1 changeover relay	8 A	Screw terminals	24 V DC / 24 → 240 V AC	88 826 105
MAR1	A - At	1 changeover relay	8 A	Screw terminals	24 V DC / 24 → 240 V AC	88 826 115
MBR1	B	1 changeover relay	8 A	Screw terminals	24V DC / 24 → 240 V AC	88 826 125
MCR1	C	1 changeover relay	8 A	Screw terminals	24 V DC / 24 → 240 V AC	88 826 135
MHR1	H - Ht	1 changeover relay	8 A	Screw terminals	24 V DC / 24 → 240 V AC	88 826 145
MLR1	Li-L	1 changeover relay	8 A	Screw terminals	24 V DC / 24 → 240 V AC	88 826 155
MUR4	A - At - B - C - H - Ht - Di - D - Ac - Bw	1 changeover relay	8 A	Screw terminals	12 V DC / AC	88 826 100
MUR3	A - At - B - C - H - Ht - Di - D - Ac - Bw	1 changeover relay	8 A	Screw terminals	12 → 240V AC / DC	88 826 103
MURc3	A - At - B - C - H - Ht - Di - D - Ac - Bw	1 changeover relay	8 A	Spring terminals	12 → 240 V AC/DC	88 826 503
MXR1	Ad - Ah - N - O - P - Pt - Tl - Tt - W	1 changeover relay	8 A	Screw terminals	24 V DC / 24 → 240 V AC	88 826 185
MUS2	A - At - B - C - H - Ht - Di - D - Ac - Bw	Solid state	0.7 A	Screw terminals	24 → 240 V AC	88 826 004
MAS5	A	Solid state	0.7 A	Screw terminals	24 → 240V AC / DC	88 826 014
MHS2	H	Solid state	0.7 A	Screw terminals	24 → 240 V AC	88 826 044
MLS2	Li - L	Solid state	0.7 A	Screw terminals	24 → 240 V AC	88 826 054

### Connections

#### 1 changeover relay output

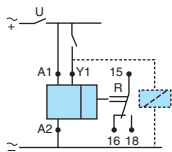

A-At / H-Ht / B / C / Di-D / Ac / BW - Ad - Ah - N - O - P - Pt - Tl - Tt - W

#### 1 changeover relay output

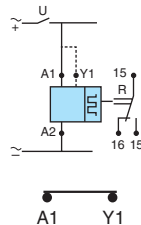

Li - L

#### Solid state output

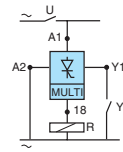

A-At / H-Ht / B / C / Di-D / Ac / BW - Ad - Ah - N - O - P - Pt - Tl - Tt - W

#### Solid state output

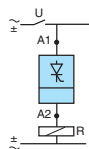

A / H

#### Solid state output

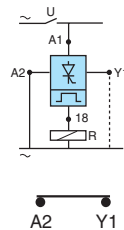

L / Li

### General characteristics

see page 45

## Dimensions

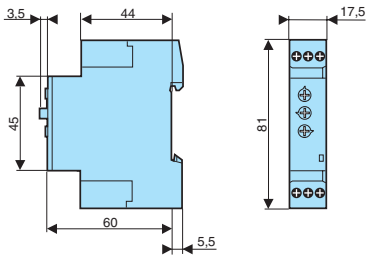

## Curves

### Function A



Delay on energisation

### Function Ah

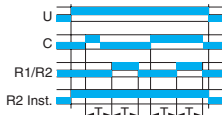

Flashing single cycle by switch (non resettable) 1 relay

### Function Bw



Pulse output (adjustable) 1 relay

### Function Di

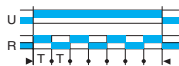

Flip-flop 1 relay Pulse start

### Function L



Double temporisation 1 relay

### Function O

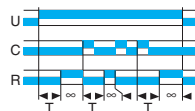

Delayed safe-guard

### Function TI

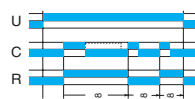

Impulse relay

### Function Ac



Timing after closing and opening of control contact

### Function At

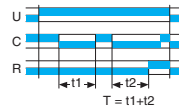

Timing on energisation with memory 1 relay

### Function C



Timing after impulse 1 timer

### Function H



Timing on energisation 1 relay

### Function Li

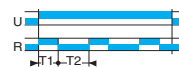

Asymmetrical recycler 1 relay Pulse start

### Function P

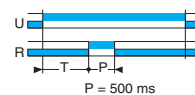

Delayed fixed-length pulse

### Function Tt

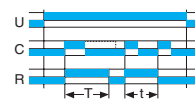

Timed impulse relay

### Function Ad



Delay on energisation by switch (non resettable) 1 relay

### Function B

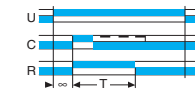

Timing on impulse one short 1 relay

### Function D

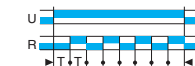

Flip-flop 1 relay Pause start

### Function Ht

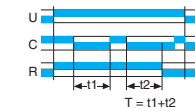

Delay on energisation with memory 1 relay

### Function N

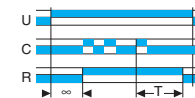

Safe-guard

### Function Pt

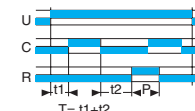

Impulse counter (delay on) 1 relay

### Function W

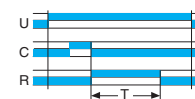

Timing after pulse on control contact

# Chronos 2 timers

## → 22.5 mm DIN rail mounting

- Multi-function or mono-function
- Multi-range
- Multi-voltage
- Screw or spring terminals
- LED status indicator
- Option of connecting an external power supply to the control input
- 3-wire sensor control option



### Specifications

Type	Functions	Output	Nominal rating	Connections	Supply voltage	Code
TUR1	A - At - B - C - H - Ht - Di - D - Ac - Bw	1 changeover relay	8 A	Screw terminals	24V DC / 24 → 240 V AC	88 865 105
TAR1	A - At	1 changeover relay	8 A	Screw terminals	24 V DC / 24 → 240 V AC	88 865 115
TBR1	B	1 changeover relay	8 A	Screw terminals	24 V DC / 24 → 240 V AC	88 865 125
TCR1	C	1 changeover relay	8 A	Screw terminals	24 V DC / 24 → 240 V AC	88 865 135
THR1	H - Ht	1 changeover relay	8 A	Screw terminals	24 V DC / 24 → 240 V AC	88 865 145
TLR1	Li - L	1 changeover relay	8 A	Screw terminals	24 V DC / 24 → 240 V AC	88 865 155
TQR1	Q	1 changeover relay	8 A	Screw terminals	24 V DC / 24 → 240 V AC	88 865 175
TUR4	A - At - B - C - H - Ht - Di - D - Ac - Bw	1 changeover relay	8 A	Screw terminals	24V DC / 24 → 240 V AC	88 865 100
TUR3	A - At - B - C - H - Ht - Di - D - Ac - Bw	1 changeover relay	8 A	Screw terminals	12 → 240 V AC / DC	88 865 103
TURc3	A - At - B - C - H - Ht - Di - D - Ac - Bw	1 changeover relay	8 A	Spring terminals	12 → 240 V AC / DC	88 865 503
TXR1	Ad - Ah - N - O - P - Pt - TL - Tt - W	1 change over relay	8 A	Screw terminals	24 V DC / 24 → 240 V AC	88 865 185
TU2R1	A - At - B - C - H - Ht - Di - D - Ac - Bw	2 timed changeover relays including 1 instantaneous	8 A	Screw terminals	24 V DC / 24 → 240 V AC	88 865 305
TA2R1	A - At	2 changeover relays	8 A	Screw terminals	24 V DC / 24 → 240 V AC	88 865 215
TK2R1	K	2 change over relays	8 A	Screw terminals	24 V DC / 24 → 240 V AC	88 865 265
TU2R4	A - At - B - C - H - Ht - Di - D - Ac - Bw	2 timed changeover relays including 1 instantaneous	8 A	Screw terminals	12 V AC / DC	88 865 300
TQR6	Q : Star / Delta	1 change over relay	8 A	Screw terminals	24 V DC / 24 → 240 V AC	88 865 176
TU2R3	A, B, C, H, Di, Ac, Bw + (At, Ht, D)	2 timed changeover relays including 1 instantaneous	8 A	Screw terminals	12 → 230 V AC	88 865 303
TX2R1	Ad - Ah - N - O - P - Pt - TL - Tt - W	2 timed changeover relays including 1 instantaneous	8 A	Screw terminals	24 V DC / 24 → 240 V AC	88 865 385

### Connections

#### 1 changeover relay output

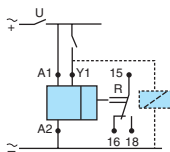

A - At - B - C - H - Ht - Di - D - Ac - Bw - Ad - Ah - N - O - P - Pt - TL - Tt -

#### 1 changeover relay output

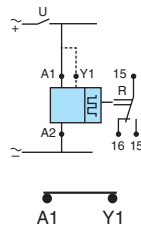

Li - L

#### 1 changeover relay output

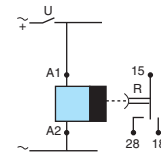

Q

#### 2 changeover relay outputs

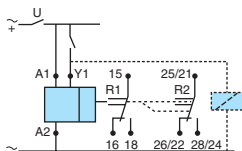

A - At - B - C - H - Ht - Di - D - Ac - Bw - Ad - Ah - N - O - P - Pt - TL - Tt - W

#### 2 changeover relay outputs

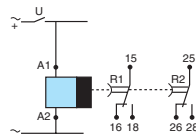

K

### General characteristics

see page 45

To order, see page 6

## Dimensions

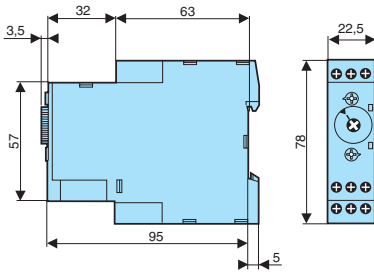

## Curves

### Function A



Delay on energisation

### Function Ac

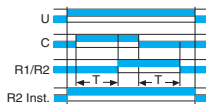

Timing after closing and opening of control contact 2 timers or 2 relays, including 1 instantaneous

### Function At

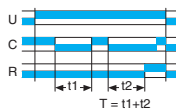

Timing on energisation with memory 1 relay output

### Function B

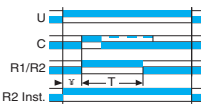

Timing on impulse one shot with 2 timed outputs or 1 timed and 1 instantaneous

### Function C



Timing after impulse 1 timer

### Function D

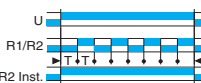

Flip-flop Pulse start with 2 timed outputs or 1 timed and 1 instantaneous

### Function A



Delay on energisation with 2 timed outputs or 1 timed and 1 instantaneous

### Function Ad



Delay on energisation by switch (non resettable)

### Function At

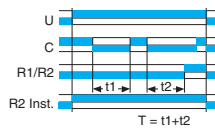

Timing on energisation with memory with 2 timed outputs or 1 timed and 1 instantaneous

### Function Bw

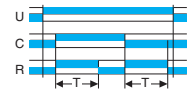

Pulse output (adjustable) 1 relay output

### Function C

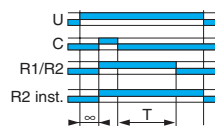

Timing after impulse with 2 timed outputs or 1 timed and 1 instantaneous

### Function Di

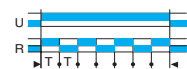

Flip-flop 1 relay output Pulse start

### Function Ac

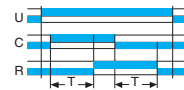

Timing after closing and opening of control contact 1 relay

### Function Ah

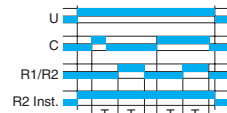

Flashing single cycle by switch (non resettable) 1 relay

### Function B

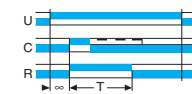

Timing on impulse one shot 1 relay output

### Function Bw

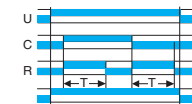

Pulse output (adjustable) with 2 timed outputs or 1 timed and 1 instantaneous

### Function D

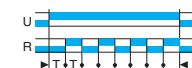

Flip-flop 1 relay output Pause start

### Function Di



Flip-flop Pulse start with 2 timed outputs or 1 timed and 1 instantaneous

**Function H**

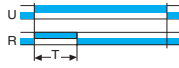

Timing on energisation 1 relay output

**Function Ht**

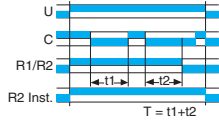

Delay on energisation with memory with 2 timed outputs or 1 timed and 1 instantaneous

**Function Li**

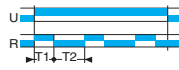

Asymmetrical recycler 1 relay output Pulse start

**Function P**

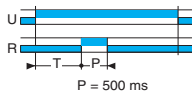

Delayed fixed-length pulse 1 relay output

**Function TI**

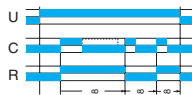

Impulse relay output

**Function H**

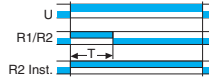

Timing on energisation with 2 timed outputs or 1 timed and 1 instantaneous

**Function K**

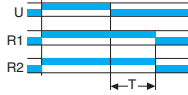

Delay on de-energisation True delay OFF 2 relay outputs

**Function N**

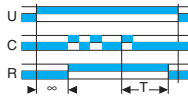

Safe-guard

**Function Pt**

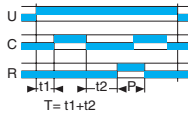

Impulse counter (delay on)

**Function Tt**

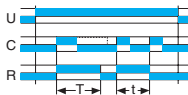

Timed impulse relay output

**Function Ht**

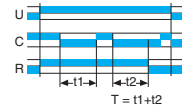

Delay on energisation with memory 1 relay output

**Function L**

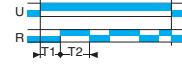

Asymmetrical recycler 1 relay output Pause start

**Function O**

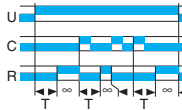

Delayed safe-guard

**Function Q**

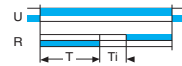

Star-delta

**Function W**



Timing after pulse on control contact





# Chronos 2 timers

## → Plug-in

- Multi-function or mono-function
- Multi-range
- Multi-voltage
- Relay output 1 or 2 : 8 A - 250 V (10 A UL)
- LED status indicator
- Option of connecting an external power supply to the control input
- 3-wire sensor control option



## Specifications

Type	Functions	Output	Nominal rating	Connections	Supply voltage	Code
OUR1	A - At - B - C - H - Ht - Di - D - Ac - Bw	1 changeover relay	8 A	8-pin	24 V DC / 24 → 240 V AC	88 867 105
OA2R1	A	2 changeover relays	8 A	8-pin	24 V DC / 24 → 240 V AC	88 867 215
OCR1	C	1 changeover relay	8 A	8-pin	24 V DC / 24 → 240 V AC	88 867 135
OLR1	Li - L	1 changeover relay	8 A	8-pin	24 V DC / 24 → 240 V AC	88 867 155
OUR4	A - At - B - C - H - Ht - Di - D - Ac - Bw	1 changeover relay	8 A	8-pin	12 V AC / DC	88 867 100
OUR3	A - At - B - C - H - Ht - Di - D - Ac - Bw	1 changeover relay	8 A	8-pin	12 → 240 V AC / DC	88 867 103
PU2R1	A - At - B - C - H - Ht - Di - D - Ac - Bw	2 timed changeover relays including 1 instantaneous	8 A	11-pin	24 V DC / 24 → 240 V AC	88 867 305
PA2R1	A - At	2 changeover relays	8 A	11-pin	24 V DC / 24 → 240 V AC	88 867 415
PC2R1	C	2 changeover relays	8 A	11-pin	24 V DC / 24 → 240 V AC	88 867 435
PL2R1	Li - L	2 changeover relays	8 A	11-pin	24 V DC / 24 → 240 V AC	88 867 455
PU2R4	A - At - B - C - H - Ht - Di - D - Ac - Bw	2 timed changeover relays including 1 instantaneous	8 A	11-pin	12 V AC / DC	88 867 300
PU2R3	A - At - B - C - Ht - Di - D - Ac - Bw	2 timed changeover relays including 1 instantaneous	8 A	11-pin	12 → 240 V AC / DC	88 867 303

## Accessories

	Code
8-pin connector base	25 622 128
11-pin connector base (for the whole range)	25 622 077

## Connections

### 8-pin 1 relay output

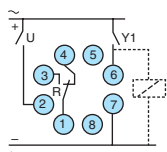

Functions A - At / H - Ht / B / C / Di - D / Ac / Bw

### 8-pin 2 relay outputs

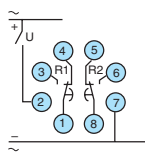

Function A

### 8-pin 1 relay output

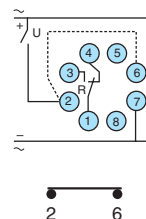

Functions Li - L

### 11-pin 2 relay outputs

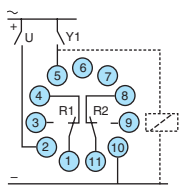

Functions A - At / H - Ht / B / C / Di - D / Ac / Bw

### 11-pin 2 relay outputs

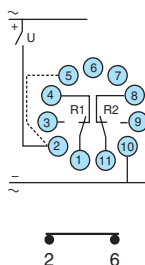

Functions L - Li

## General characteristics

see page 45

## Dimensions

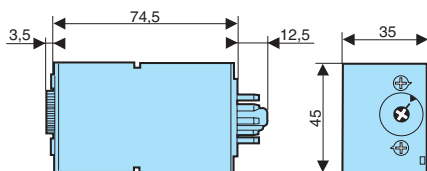

## Accessories

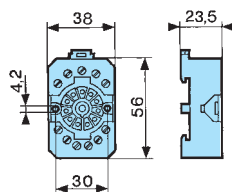

## Curves

### Function A



Delay on energisation 1 relay output

### Function A

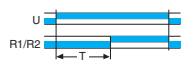

Delay on energisation 2 timers

### Function A



Delay on energisation with 2 timed outputs or 1 timed and 1 instantaneous

### Function Ac



Timing after closing and opening of control contact 1 relay output

### Function Ac



Timing after closing and opening of control contact with 2 timed outputs or 1 timed and 1 instantaneous

### Function At

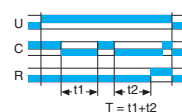

Timing on energisation with memory 1 relay output

### Function At

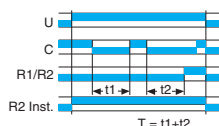

Timing on energisation with memory with 2 timed outputs or 1 timed and 1 instantaneous

### Function B



Timing on impulse one shot 1 relay output

### Function B

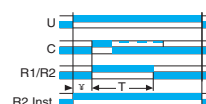

Timing on impulse one shot with 2 timed outputs or 1 timed and 1 instantaneous

### Function Bw



Pulse output (adjustable) 1 relay output

### Function Bw

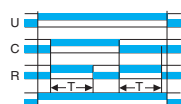

Pulse output (adjustable) with 2 timed outputs or 1 timed and 1 instantaneous

### Function C



Timing after impulse 1 timer

### Function C

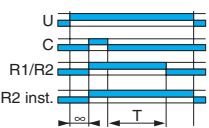

Timing after impulse with 2 timed outputs or 1 timed and 1 instantaneous

### Function D

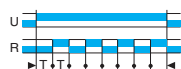

Flip-flop 1 relay output Pause start

### Function D



Flip-flop Pause start with 2 timed outputs or 1 timed and 1 instantaneous

### Function Di



Flip-flop 1 relay output Pulse start

### Function Di



Flip-flop Pause start with 2 timed outputs or 1 timed and 1 instantaneous

### Function H



Timing on energisation 1 relay output

**Function H**

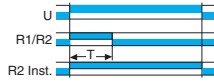

Timing on energisation 2 timers or 2 relays, including 1 instantaneous

**Function L**



Asymmetrical recycler 1 relay Pause start

**Function Li**

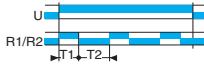

Asymmetrical recycler 1 relay Pulse start 2 timers

**Function Ht**

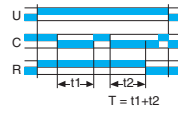

Delay on energisation with memory 1 relay

**Function L**

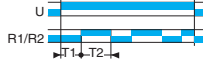

Asymmetrical recycler 1 relay Pulse start 2 timers

**Function Ht**

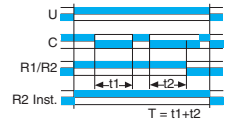

Delay on energisation with memory 2 timers or 2 relays, including 1 instantaneous

**Function Li**

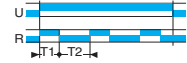

Asymmetrical recycler 1 relay Pulse start

# Chronos 2 timers: general characteristics

→ 17.5 mm

→ 22.5 mm

→ Plug-in

Timing	
Repetition accuracy with constant parameters	± 0.5 % (IEC 1812-1)
Temperature drift	± 0.05 % / °C
Voltage drift	± 0.2 % / V
Display accuracy according to IEC 1812-1	± 10 % / 25°C
Minimum pulse duration typically (relay version)	30 ms
Minimum pulse duration typically (solid state version)	50 ms
Minimum pulse duration typically (relay version under load)	100 ms
Maximum reset time by de-energisation typically (relay version)	100 ms
Maximum reset time by de-energisation typically (solid state version)	350 ms
Immunity from micro power cuts : typical	> 10 ms
Supply	
Multi-voltage power supply	Depending on version
Frequency (Hz)	50 / 60
Operating range	85 to 110 % Un (85 to 120 % Un for 12V AC/DC)
Operator factor	100 %
Max. absorbed power	0.6 W 24 V AC/DC 1.5 W 230 V AC 32 VA 230 V AC
Output specification	
Relay output	
1 or 2 changeover relays, AgNi (cadmium-free)	2000 VA/80 W
Rated power	2000 VA/80 W
Maximum breaking current	8 A AC 8A DC
Minimum breaking current	10 mA / 5 V DC
Voltage breaking capacity	250 V AC/V DC
Electrical life (operations)	10 <sup>5</sup> operations 8 A 250 V resistive
Mechanical life (operations)	5x10 <sup>6</sup>
Breakdown voltage acc. to IEC 1812-1	2.5 kV / 1 min / 1 mA / 50 Hz
Impulse voltage acc. to IEC 664-1, IEC 1812-1	5 kV, wave 1.2 / 50 µs
Solid state output 17.5 mm	
Rated power	0.7 A AC/DC 20 °C (0.5 A UL)
Derating	5 mA / °C
Maximum admissible current	20 A ≤ 10 ms
Minimum breaking current	10 mA
Leakage current	< 5 mA
Voltage breaking capacity	250 V AC/V DC
Maximum voltage drop at terminals	3 wire 4V - 2 wire 8V
Electrical life (operations)	10 <sup>8</sup>
Mechanical life (operations)	10 <sup>8</sup>
Breakdown voltage acc. to IEC 664, IEC 255-5	2.5 kV to 1 mA / 1 min
Input type	Volt-free contact 3-wire PNP output control option residual voltage : 0.4V whatever the timer power supply
Timing ranges (7 ranges)	1 s - 10 s - 1 min - 10 min - 1 h - 10 h - 100 h

Other characteristics	
Conforming to standards IEC 1812-1, EN 50081-1/2, EN 50082-1/2, LV directives (73/23/EEC + 93/68/EEC (CE marking) + EMC (89/336/EEC + IEC 669-2-3 (17.5 mm))	•
Approvals	•
UL - CSA - cUL pending	
Temperatures limits use (°C)	-20 → +60
Temperature limits stored (°C)	-30 → +60
Installation category (acc. to IEC 664-1)	Voltage surge category
Creepage distance and clearance acc. to IEC 664-1	4 kV / 3
Protection (IEC 529) Terminal	IP 20
Protection (IEC 529) Housing	IP 40
Degree of protection acc. to IEC 529 Front face (except Tk2R1)	IP 50
Vibration resistance acc. to IEC 68-2-6	f = 10 - 55 Hz A = 0.35 mm
Relative humidity no condensation acc. to 68-2-3	93 % without condensation
Electromagnetic compatibility - Immunity to electrostatic discharges acc to IEC 1000-42	Level III (Air 8 kV / Contact 6 kV)
Immunity to electrostatic fields acc. ENV 50140/204 (IEC 1000-4-3)	Level III 10V/m (80 MHz to 1 GHz)
Immunity to rapid transient bursts acc. to IEC 1000-4-4	Level III (direct 2kV / Capacitive coupling clamp 1 kV)
Immunity to shock waves on power supply acc. to IEC 1000-4-5	Level III (2 kV / common mode 2 kV/residual current mode 1kV)
Immunity to radiofrequency in common mode acc. to ENV (CEI 1000-4-6)	Level III (10V rms : 0.15 MHz to 80 MHz)
Immunity to voltage dips and breaks acc. to IEC 1000-4-11	30 %/10 ms 60 %/100 ms > 95 %/5 s
Mains-borne and radiated emissions acc. to EN 55022 (EN 55011 Group 1)	Class B
Fixing : Symmetrical DIN rail (EN 50022)	35 mm
Connection capacity - without ferrule	2 x 2.5 mm <sup>2</sup>
Connection capacity - with ferrule	2 x 1.5 mm <sup>2</sup>
Spring terminals, 2 terminals per connection point - flexible wire	1.5 mm <sup>2</sup>
Spring terminals, 2 terminals per connection point - rigid wire	2.5 mm <sup>2</sup>
Material housing	Self-extinguishing
Weight : casing 17.5 mm	60 g
Weight : casing 22.5 mm	90 g
Weight : plug-in casing	80 g

# RTM miniature timers

## → Plug-IN

- Miniature plug-in timer (21 x 27 mm)
- Function A : Delay on energisation
- Multi-range 0.1 s to 10 h
- Excellent noise resistance
- Relay output, 2 or 4 changeover contacts



### Specifications

Type	Functions	Relay outputs	Nominal rating	Supply voltage	Absorbed power (W)	Code
RTMA2	A	2 timed changeover	5 A AC	12 VDC	1.5	88 895 201
	A	2 timed changeover	5 A AC	24 VDC	1.2	88 895 202
	A	2 timed changeover	5 A AC	24 VAC	1.7	88 895 203
	A	2 timed changeover	5 A AC	110 VAC	2.6	88 895 206
	A	2 timed changeover	5 A AC	230 VAC	3	88 895 207
RTMA4	A	4 timed changeover	3 A AC	12 V DC	1.5	88 896 201
	A	4 timed changeover	3 A AC	24 V DC	1.2	88 896 202
	A	4 timed changeover	3 A AC	24 V AC	1.7	88 896 203
	A	4 timed changeover	3 A AC	127 V AC	2.6	88 896 206
	A	4 timed changeover	3 A AC	230 V AC	3	88 896 207

### Accessories

	Code
PCB base RTMA2	26 532 709
Base for DIN rail mounting RTMA2	26 532 707
Spring clips for DIN rail mounting base	26 532 702
Spring clips for PCB base	26 532 704
PCB base RTMA4	26 532 708
Base for DIN rail mounting RTMA4	26 532 706

### Connections

#### RTMA 2

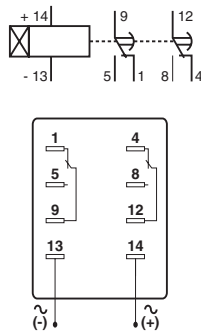

13 - 14 Supply  
1 - 5 - 9 / 4 - 8 - 12 Timed or instantaneous (switch set to "INST") relay outputs

#### RTMA4

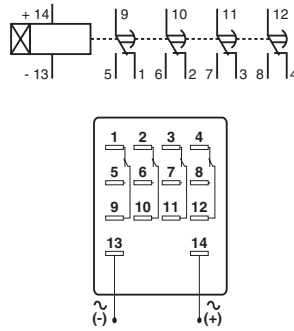

13 - 14 Supply  
1 - 5 - 9 / 2 - 6 - 10 / 3 - 7 - 11 / 4 - 8 - 11 Timed or instantaneous (switch set to "INST") relay outputs

## General characteristics

Timing ranges	0.1 → 1s 1 → 10s 0.1 → 1 min 1 → 10 min 0.1 → 1h 1 → 10 h 10 → 100 h
Display accuracy	-0 % / + 10 % at 25 °C of full scale, according to CEI/EN61812
Repetition accuracy (with constant parameters)	± 0.5 %
Drift Temperature	± 0.05 %/°C
Drift Voltage	± 0.2 %/V
Maximum reset time by de-energisation during timed delay	50 ms
Maximum reset time by de-energisation after timing	250 ms
Operating range	±15 % of supply (AC) ±10 % of supply (DC)
Frequency (Hz)	50/60 Hz ± 1 Hz
Immunity from micro power cuts : typical	< 5 ms
Ripple	± 10 % (DC)
Operator factor	100 %
<b>Output specification</b>	
Maximum power rating (resistive)	1250 VA / 120 W
Minimum current	100 mA
Maximum breaking voltage	250 V AC
Type of contacts	AgNi
Max. permitted number of operations at 1 max 250 V AC resistive per hour	600
Electrical life at I max., 250 V AC resistive (number of operations)	10 <sup>5</sup>
Mechanical life (operations)	10 <sup>7</sup>
Breakdown voltage conforming to IEC/EN 61812-1 and 60601-1	2 kV at 1 mA / 1 min / 50 Hz
<b>Function and use</b>	
Display of output state by LED	Green : power on yellow : output on
Conformity to standards	CEI/EN61812-1, CEI/EN60601-1, EN50081-2, EN61000-6-2, CEI/EN60601-1-2, Directives BT (73/23/CEE + 93/68/CEE (CE marking) ) + CEM (89/336/CEE)
Approvals	UL - cUL
Temperatures limits use (°C)	-20 → +60
Temperature limits stored (°C)	-40 → +70
Insulation coordination (IEC 60664-1)	4 kV / surge category 3
Degree of protection IEC 60529	IP 50 (casing)
Vibration resistance acc. to IEC 68-2-6	f = 10 → 55 Hz A = 0.35 mm
Relative humidity (no condensation)	95 % max (CEI 60068-2-3)
Electromagnetic compatibility	Class 2 according to EN61812-1/A11
Immunity to electrostatic discharges acc. IEC/EN 61000-4-2	Level III (Air 8 K : contact 6kV)
Immunity to electrostatic fields acc. ENV 50140/204 (IEC 1000-4-3)	Level III (10 V/m : 26 MHz to 1 GHz / 900 MHz)
Immunity to rapid transient bursts acc. to IEC 1000-4-4	Level III (Direct 2 kV : coupled 1kV)
Immunity to radio frequency in common mode acc. to ENV (CEI 1000-4-6)	Level III (10 V (rms) : 0.15 MHz to 80 Mhz)
Immunity to shock waves according to IEC/EN 61000-4-5	AC : level III (common mode 2 kV, differential mode : 1 kV) DC : MC/MD : 0.5 kV
Immunity to voltage dips and breaks acc. to IEC 1000-4-11	30 % / 10 ms 60 % / 100 ms / 1 s > 95 % 5 s
Mains-borne and radiated emissions acc. to EN 55022 (EN 55011 Group 1)	Class B
Material housing	Self-extinguishing
Weight (g)	55

## Dimensions

Base for DIN rail mounting  
RTMA2 - 26 532 707

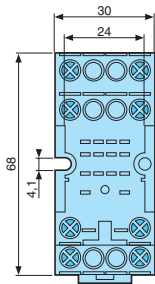

Spring clip for DIN rail base  
26 532 702

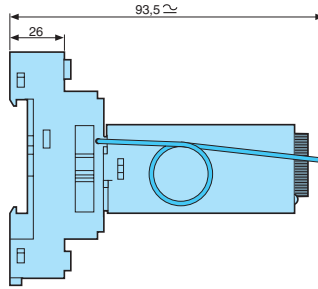

Spring clip for PCB base  
26 532 704

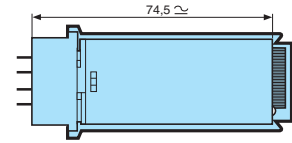

Base for DIN rail mounting  
RTMA4 - 26 532 706

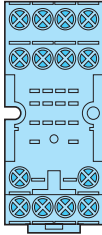

PCB base RTMA4 - 26 532 708

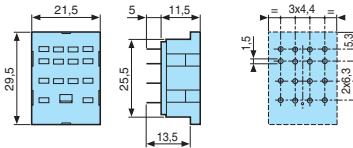

PCB base RTMA2  
26 532 709

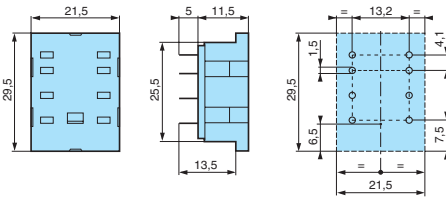

RTMA2 - RTMA4

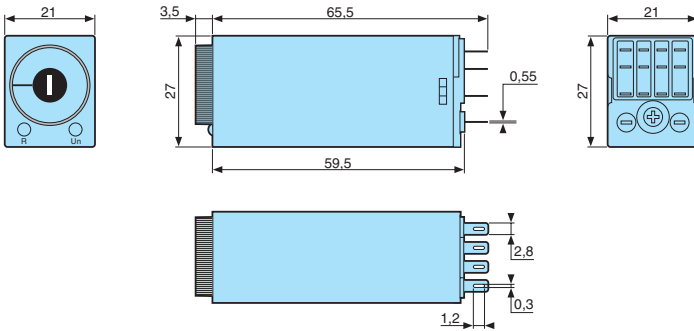

## Curves

RTMA2

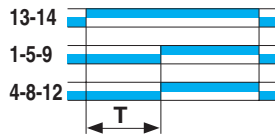

2 relays

RTMA4

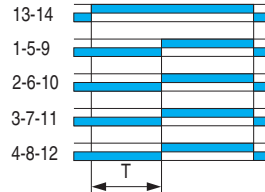

4 relays

## Other information

For single-range versions, please consult us.





# S/SE timers

## → Delay on energisation

### Solid state output

- Mono-function
- Mono-range-timing fixed, or adjustable by external or built-in potentiometer
- Mono-voltage
- Solid state output 0.7 A at 20 °C
- Versions : 2 or 3 wire
- Fully sealed for protection by encapsulation in polyurethane resin
- Connection by 6.35 mm Faston blade terminals



### Specifications

Type	Voltage	Functions	Maximum timing (to be specified or ordering)	Features	Code
SAS 88 870 1	12 V DC	A	60 min	Timing, series connection	•
	24 V AC DC 50/60 Hz	A	60 min	Timing, series connection	•
	48 V AC DC 50/60 Hz	A	60 min	Timing, series connection	•
	110 V AC 50/60 Hz DC	A	60 min	Timing, series connection	•
	220 → 240 V AC 50/60 Hz DC	A	60 min	Timing, series connection	•
SASP 88 870 1	12 V DC	Ap	100 s	Adjustable timing with integral potentiometer	•
	24 V AC DC 50/60 Hz	Ap	100 s	Adjustable timing with integral potentiometer	•
	48 V AC DC 50/60 Hz	Ap	100 s	Adjustable timing with integral potentiometer	•
	110 V AC 50/60 Hz DC	Ap	100 s	Adjustable timing with integral potentiometer	•
	220 → 240 V AC 50/60 Hz DC	Ap	100 s	Adjustable timing with integral potentiometer	•
SASD 88 870 1	12 V DC	Ad	60 min	Adjustable timing with remote potentiometer	•
	24 V AC DC 50/60 Hz	Ad	60 min	Adjustable timing with remote potentiometer	•
	48 V AC DC 50/60 Hz	Ad	60 min	Adjustable timing with remote potentiometer	•
	110 V AC 50/60 Hz DC	Ad	60 min	Adjustable timing with remote potentiometer	•
	220 → 240 V AC 50/60 Hz DC	Ad	60 min	Adjustable timing with remote potentiometer	•
SAIS 88 870 1	12 V DC	Ai	60 min	Timing, parallel connection	•
	24 V AC DC 50/60 Hz	Ai	60 min	Timing, parallel connection	•
	48 V AC DC 50/60 Hz	Ai	60 min	Timing, parallel connection	•
	110 V AC 50/60 Hz DC	Ai	60 min	Timing, parallel connection	•
	220 → 240 V AC 50/60 Hz DC	Ai	60 min	Timing, parallel connection	•

### General characteristics

Accuracy	Function A, Ai, Ad : ± 10 % Function Ap : -10 % +30 %
Repetition accuracy (with constant parameters)	± 0.5 %
Variation according to VDE 0435	0 +40 °C : ± 3 % -20 +60 °C : ± 5 %
Reset time during timed delay	150 ms
Reset time after timing	25 ms
Immunity from micro power cuts	< 20 ms
Nominal current - I max at 20 °C	0.7 A
Nominal current - I min	10 mA
Maximum admissible current	20 A < 0.01 s
Leakage current at 20 °C	≤ 5 mA
Voltage drop at terminals	3.5 V
Derating	5 mA /°C
Electrical life (number of operations)	> 10 <sup>8</sup>
Weight (g)	SAS, SASP, SASD : 55 g SAIS : 60 g

To order, see page 6. Accessories, dimensions, function and use, Other information, see page 61.

## Connections

SAS

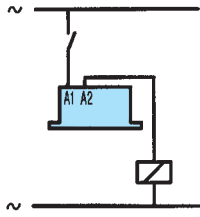

SASP

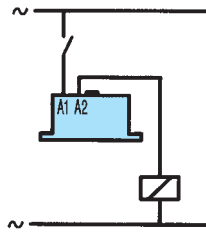

SASD

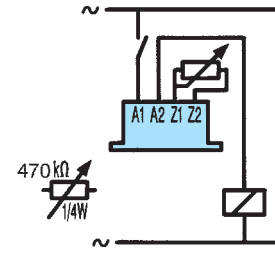

SAIS

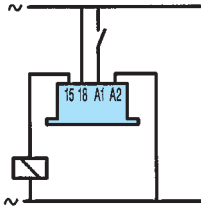

## Curves

Function A

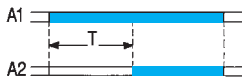

Function Ap

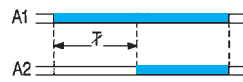

Function Ad

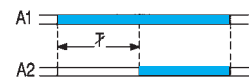

Function Ai

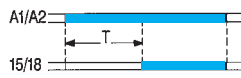

# S/SE timers

## → Timing on impulse, one shot

### Solid state output

- Mono-range-timing fixed, or adjustable by external or built-in potentiometer
- Mono-voltage
- Solid state output 0.7 A at 20 °C
- Versions : 2 or 3 wire
- Fully sealed for protection by encapsulation in polyurethane resin
- Connection by 6.35 mm Faston blade terminals



### Specifications

Type	Voltage	Functions	Maximum timing (to be specified or ordering)	Features	Code
SBS 88 870 2	24 V AC 50/60 Hz	B	60 min	Fixed timing	•
	48 V AC 50/60 Hz	B	60 min	Fixed timing	•
	110 V AC 50/60 Hz	B	60 min	Fixed timing	•
	230 V AC 50/60 Hz	B	60 min	Fixed timing	•
SBSP 88 870 2	24 V AC 50/60 Hz	Bp	100 s	Adjustable timing with integral potentiometer	•
	48 V AC 50/60 Hz	Bp	100 s	Adjustable timing with integral potentiometer	•
	110 V AC 50/60 Hz	Bp	100 s	Adjustable timing with integral potentiometer	•
	230 V AC 50/60 Hz	Bp	100 s	Adjustable timing with integral potentiometer	•
SBSD 88 870 2	24 V AC 50/60 Hz	Bd	60 min	Adjustable timing with remote potentiometer	•
	48 V AC 50/60 Hz	Bd	60 min	Adjustable timing with remote potentiometer	•
	110 V AC 50/60 Hz	Bd	60 min	Adjustable timing with remote potentiometer	•
	230 V AC 50/60 Hz	Bd	60 min	Adjustable timing with remote potentiometer	•

### General characteristics

Accuracy	Function B, Bd : ± 10 % Function Bp : -10 % +30 %
Repetition accuracy (with constant parameters)	± 0.5 %
Variation according to VDE 0435	0 +40 °C : ± 3 % -20 +60 °C : ± 5 %
Min. control pulse	20 ms
Reset time during timed delay	800 ms
Immunity from micro power cuts	< 20 ms
Nominal current - I max at 20 °C	0.7 A
Nominal current - I min	5 mA
Maximum admissible current	20 A < 0.01 s
Leakage current at 20 °C	≤ 2 mA
Voltage drop at terminals	3.5 V
Derating	5 mA / C
Electrical life (number of operations)	> 10 <sup>8</sup>
Weight (g)	55

### Curves

#### Function B



#### Function Bp



#### Function Bd



### Connections

#### SBS

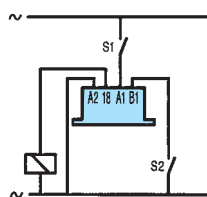

#### SBSP

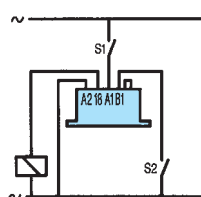

#### SBSD

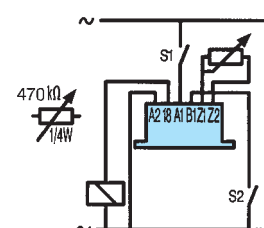

To order, see page 6. Accessories, dimensions, function and use, Other information, see page 61.

# S/SE timers

## → Timing after impulse

### Solid state output

- Mono-range-timing fixed, or adjustable by external or built-in potentiometer
- Mono-voltage
- Solid state output 0.7 A at 20 °C
- Versions : 2 or 3 wire
- Fully sealed for protection by encapsulation in polyurethane resin
- Connection by 6.35 mm Faston blade terminals



### Specifications

Type	Voltage	Functions	Maximum timing (to be specified or ordering)	Features	Code
SCS 88 870 3	24 V AC 50/60 Hz	C	60 min	Fixed timing	•
	48 V AC 50/60 Hz	C	60 min	Fixed timing	•
	110 V AC 50/60 Hz	C	60 min	Fixed timing	•
	230 V AC 50/60 Hz	C	60 min	Fixed timing	•
SCSP 88 870 3	24 V AC 50/60 Hz	Cp	100 s	Adjustable timing with integral potentiometer	•
	48 V AC 50/60 Hz	Cp	100 s	Adjustable timing with integral potentiometer	•
	110 V AC 50/60 Hz	Cp	100 s	Adjustable timing with integral potentiometer	•
	230 V AC 50/60 Hz	Cp	100 s	Adjustable timing with integral potentiometer	•
SCSD 88 870 3	24 V AC 50/60 Hz	Cd	60 min	Adjustable timing with remote potentiometer	•
	48 V AC 50/60 Hz	Cd	60 min	Adjustable timing with remote potentiometer	•
	110 V AC 50/60 Hz	Cd	60 min	Adjustable timing with remote potentiometer	•
	230 V AC 50/60 Hz	Cd	60 min	Adjustable timing with remote potentiometer	•

### General characteristics

Accuracy	Function C, Cd : $\pm 10 \%$ Function Cp : $-10 \%$ $+30 \%$
Repetition accuracy (with constant parameters)	$\pm 0.5 \%$
Variation according to VDE 0435	0 $+40 \text{ }^\circ\text{C}$ : $\pm 3 \%$ -20 $+60 \text{ }^\circ\text{C}$ : $\pm 5 \%$
Min. control pulse	20 ms
Reset time during timed delay	800 ms
Immunity from micro power cuts	< 20 ms
Nominal current - I max at 20 °C	0.7 A
Nominal current - I min	5 mA
Maximum admissible current	20 A < 0.01 s
Leakage current at 20 °C	$\leq 2 \text{ mA}$
Voltage drop at terminals	3.5 V
Derating	5 mA / C
Electrical life (number of operations)	$> 10^8$

### Curves

#### Function C



#### Function Cp

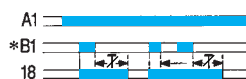

#### Function Cd



### Connections

#### SCS

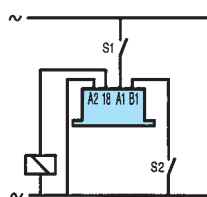

#### SCSP

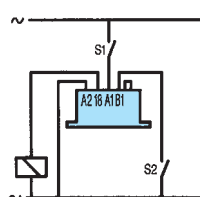

#### SCSD

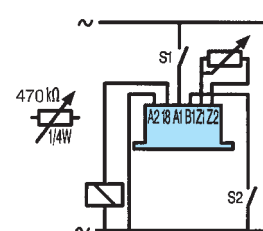

To order, see page 6. Accessories, dimensions, function and use, Other information, see page 61.

# S/SE timers

## → Timing on energisation

### Solid state output

- Mono-funtion
- Mono-range-timing fixed, or adjustable by external or built-in potentiometer
- Mono-voltage
- Solid state output 0.7 A at 20 °C
- Versions : 2 or 3 wire
- Fully sealed for protection by encapsulation in polyurethane resin
- Connection by 6.35 mm Faston blade terminals



### Specifications

Type	Voltage	Functions	Maximum timing (to be specified or ordering)	Features	Code
SHSB 88 870 4	24 V AC 50/60 Hz	H (2 wire)	60 min	Fixed timing	•
	48 V AC 50/60 Hz	H (2 wire)	60 min	Fixed timing	•
	110 V AC 50/60 Hz	H (2 wire)	60 min	Fixed timing	•
	230 V AC 50/60 Hz	H (2 wire)	60 min	Fixed timing	•
SHSBP 88 870 4	24 V AC 50/60 Hz	Hp (2 wire)	100 s	Adjustable timing with integral potentiometer	•
	48 V AC 50/60 Hz	Hp (2 wire)	100 s	Adjustable timing with integral potentiometer	•
	110 V AC 50/60 Hz	Hp (2 wire)	100 s	Adjustable timing with integral potentiometer	•
	230 V AC 50/60 Hz	Hp (2 wire)	100 s	Adjustable timing with integral potentiometer	•
SHSBD 88 870 4	24 V AC 50/60 Hz	Hd (2 wire)	60 min	Adjustable timing with remote potentiometer	•
	48 V AC 50/60 Hz	Hd (2 wire)	60 min	Adjustable timing with remote potentiometer	•
	110 V AC 50/60 Hz	Hd (2 wire)	60 min	Adjustable timing with remote potentiometer	•
	230 V AC 50/60 Hz	Hd (2 wire)	60 min	Adjustable timing with remote potentiometer	•
SHIS 88 870 4	24 V AC 50/60 Hz	Hi (4 wire)	60 min	Fixed timing	•
	48 V AC 50/60 Hz	Hi (4 wire)	60 min	Fixed timing	•
	110 V AC 50/60 Hz	Hi (4 wire)	60 min	Fixed timing	•
	230 V AC 50/60 Hz	Hi (4 wire)	60 min	Fixed timing	•
SHS 88 870 4	24 V AC 50/60 Hz	H (3 wire)	100 s	Fixed timing	•
	48 V AC 50/60 Hz	H (3 wire)	100 s	Fixed timing	•
	110 V AC 50/60 Hz	H (3 wire)	100 s	Fixed timing	•
	230 V AC 50/60 Hz	H (3 wire)	100 s	Fixed timing	•
SHSP 88 870 4	24 V AC 50/60 Hz	H (3 wire)	100 s	Adjustable timing with integral potentiometer	•
	48 V AC 50/60 Hz	H (3 wire)	100 s	Adjustable timing with integral potentiometer	•
	110 V AC 50/60 Hz	H (3 wire)	100 s	Adjustable timing with integral potentiometer	•
	230 V AC 50/60 Hz	H (3 wire)	100 s	Adjustable timing with integral potentiometer	•
SHSD 88 870 4	24 V AC 50/60 Hz	Hp (2 wire)	60 min	Adjustable timing with remote potentiometer	•
	48 V AC 50/60 Hz	Hp (2 wire)	60 min	Adjustable timing with remote potentiometer	•
	110 V AC 50/60 Hz	Hp (2 wire)	60 min	Adjustable timing with remote potentiometer	•
	230 V AC 50/60 Hz	Hp (2 wire)	60 min	Adjustable timing with remote potentiometer	•

### General characteristics

Accuracy	Function H, Hd, Hi : $\pm 10\%$ Function Hp : $-10\%$ $+30\%$
Repetition accuracy (with constant parameters)	$\pm 0.5\%$
Variation according to VDE 0435	0 $+40\text{ }^\circ\text{C}$ : $\pm 3\%$ $-20$ $+60\text{ }^\circ\text{C}$ : $\pm 5\%$
Reset time during timed delay	150 ms
Reset time after timing	150 ms
Immunity from micro power cuts	$< 20$ ms
Nominal current - I max at 20 °C	0.7 A
Nominal current - I min	Function H, Hi : 5 mA Function HB : 15 mA
Maximum admissible current	20 A $< 0.01$ s
Leakage current at 20 °C	Function H, Hi : $\leq 2$ mA Function HB : $\leq 6$ mA
Voltage drop at terminals	Function H, Hi : 3.5 V Function HB : 8 V
Derating	5 mA / $^\circ\text{C}$
Electrical life (number of operations)	$> 10^8$
Weight (g)	H, Hd, Hp : 50 Hi : 60

To order, see page 6. Accessories, dimensions, function and use, Other information, see page 61.

## Curves

Function Hb

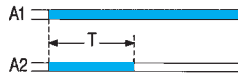

Function Hp

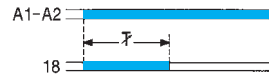

Function Hd



Function Hi



Function H

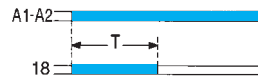

## Connections

SHSB

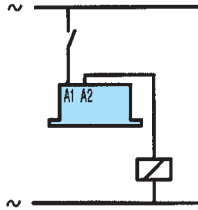

SHSBP

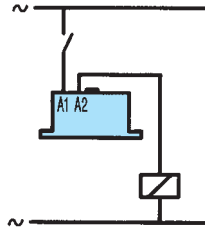

SHSBD

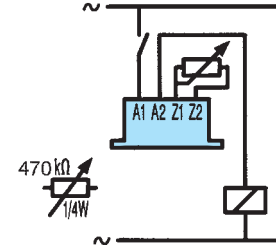

SHIS

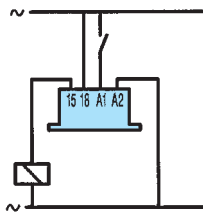

SHS

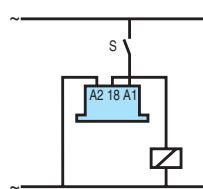

SHSP

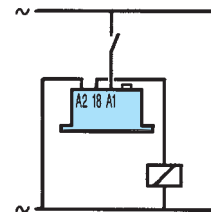

SHSD

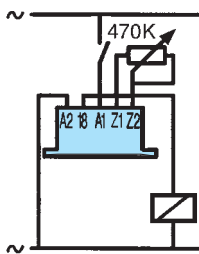

2

# S/SE timers

## → Cyclic timing functions

### Solid state output

- Mono-funtion
- Mono-range-timing fixed, or adjustable by external or built-in potentiometer
- Mono-voltage
- Solid state output 0.7 A at 20 °C
- Fully sealed for protection by encapsulation in polyurethane resin
- Connection by 6.35 mm Faston blade terminals



### Specifications

Type	Voltage	Functions	Maximum timing (to be specified or ordering)	Features	Code
SDSB 88 870 5	24 V AC 50/60 Hz	E	10 min	Fixed timing	•
	48 V AC 50/60 Hz	E	10 min	Fixed timing	•
	110 V AC 50/60 Hz	E	10 min	Fixed timing	•
	230 V AC 50/60 Hz	E	10 min	Fixed timing	•
SDSBP 88 870 5	24 V AC 50/60 Hz	Ep	10 min	Adjustable timing with integral potentiometer	•
	48 V AC 50/60 Hz	Ep	10 min	Adjustable timing with integral potentiometer	•
	110 V AC 50/60 Hz	Ep	10 min	Adjustable timing with integral potentiometer	•
	230 V AC 50/60 Hz	Ep	10 min	Adjustable timing with integral potentiometer	•
SDSB 88 870 5	24 V AC 50/60 Hz	Ed	10 min	Adjustable timing with remote potentiometer	•
	48 V AC 50/60 Hz	Ed	10 min	Adjustable timing with remote potentiometer	•
	110 V AC 50/60 Hz	Ed	10 min	Adjustable timing with remote potentiometer	•
	230 V AC 50/60 Hz	Ed	10 min	Adjustable timing with remote potentiometer	•
SDS1A 88 870 5	10 → 50 V AC 50/60 Hz	E1	1 s	Fixed timing	•
SDS2A 88 870 5	40 → 240 V AC 50/60 Hz	E1	1 s	Fixed timing	•
SDS1B 88 870 5	10 → 50 V AC 50/60 Hz	E2	1 s	Fixed timing	•
SDS2B 88 870 5	40 → 240 V AC 50/60 Hz	E2	1 s	Fixed timing	•

### General characteristics

Accuracy	Functions E, Ed : ± 10 % Functions Ep, E1, E2 : -10 % +30 %
Repetition accuracy (with constant parameters)	± 0.5 % (E, Ep, Ed)
Variation according to VDE 0435	0 +40 °C : ± 3 % -20 +60 °C : ± 5 %
Reset time during timed delay	150 ms
Immunity from micro power cuts	< 20 ms
Nominal current - I max at 20 °C	Functions E, Ed, Ep : 0.7 A Functions E1, E2 : 1 A
Nominal current - I min	Functions E, Ed, Ep : 15 mA Functions E1, E2 : 10 mA
Maximum admissible current	20 A < 0.01 s
Leakage current at 20 °C	≤ 6 mA
Voltage drop at terminals	Functions E, Ed, Ep : 8 V Functions E1, E2 : 5 V
Derating	Functions E, Ed, Ep : 5 mA / °C Functions E1, E2 : 10 mA / °C
Electrical life (number of operations)	> 10 <sup>8</sup>
Weight (g)	E, Ed, Ep : 50 E1, E2 : 60

To order, see page 6. Accessories, dimensions, function and use, Other information, see page 61.



## Connections

SDSB

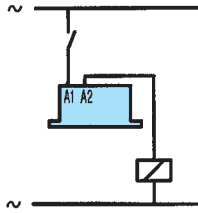

SDSBP

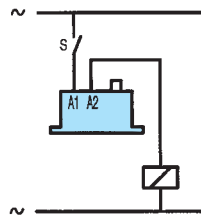

SDSBD

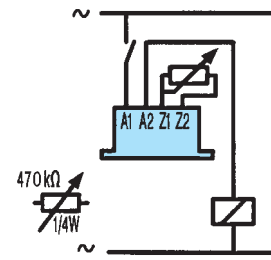

SDS1A or 2A

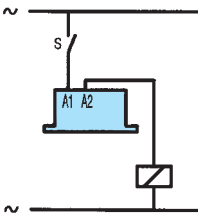

## Curves

Function E

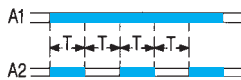

Function Ep

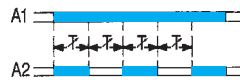

Function Ed

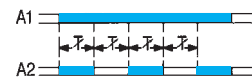

Function E1

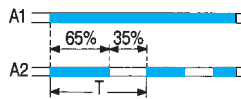

Function E2

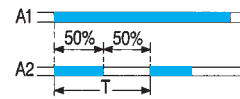

# S/SE timers

## → Fixed cyclic timing

### Solid state output

- Mono-funtion
- Mono-range-timing fixed
- Mono-voltage
- Solid state output 0.7 A at 20 °C
- Percentage timer
- Fully sealed for protection by encapsulation in polyurethane resin
- Connection by 6.35 mm Faston blade terminals



### Specifications

Type	Voltage	Functions	Maximum timing (to be specified or ordering)	Features	Code
SGS 88 870 7	24 V AC 50/60 Hz	La : cyclic, pause start	T on : 60 min / T off : 60 min	Fixed timing	•
	48 V AC 50/60 Hz	La : cyclic, pause start	T on : 60 min / T off : 60 min	Fixed timing	•
	110 V AC 50/60 Hz	La : cyclic, pause start	T on : 60 min / T off : 60 min	Fixed timing	•
	230 V AC 50/60 Hz	La : cyclic, pause start	T on : 60 min / T off : 60 min	Fixed timing	•
SGSI 88 870 7	24 V AC 50/60 Hz	L : cyclic, pulse start	T on : 60 min / T off : 60 min	Fixed timing	•
	48 V AC 50/60 Hz	L : cyclic, pulse start	T on : 60 min / T off : 60 min	Fixed timing	•
	110 V AC 50/60 Hz	L : cyclic, pulse start	T on : 60 min / T off : 60 min	Fixed timing	•
	230 V AC 50/60 Hz	L : cyclic, pulse start	T on : 60 min / T off : 60 min	Fixed timing	•

### General characteristics

#### Precision

Repetition accuracy (with constant parameters)	± 0.5 %
Variation according to VDE 0435	0 +40 °C : ± 3 % -20 +60 °C : ± 5 %
Reset time during timed delay	200 ms
Reset time after timing	200 ms (SFS)
Immunity from micro power cuts	< 20 ms

#### Output specification

Nominal current - I max at 20 °C	0.7 A
Nominal current - I min	5 mA
Maximum admissible current	20 A < 0.01 s
Leakage current at 20 °C	≤ 5 mA
Voltage drop at terminals	3.5 V
Derating	5 mA / °C
Electrical life (number of operations)	> 10 <sup>8</sup>
Weight (g)	55

### Curves

Function La

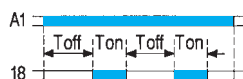

Function L

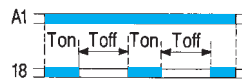

### Connections

#### SGS - SGSI

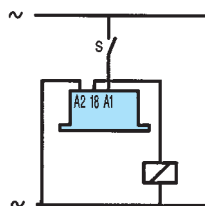

To order, see page 6. Dimensions see page 61.

# S/SE timers

## → Percentage timer

### Solid state output

- Mono-funtion
- Mono-range-timing fixed
- Mono-voltage
- Solid state output 0.7 A at 20 °C
- Percentage timer
- Fully sealed for protection by encapsulation in polyurethane resin
- Connection by 6.35 mm Faston blade terminals



### Specifications

Type	Voltage	Functions	Maximum timing (to be specified or ordering)	Features	Code
SFS 88 870 9	24 V AC 50/60 Hz	X	T1 : 60 min / T2 : 60 min	Fixed timing	•
	48 V AC 50/60 Hz	X	T1 : 60 min / T2 : 60 min	Fixed timing	•
	110 V AC 50/60 Hz	X	T1 : 60 min / T2 : 60 min	Fixed timing	•
	230 V AC 50/60 Hz	X	T1 : 60 min / T2 : 60 min	Fixed timing	•

### General characteristics

Accuracy	± 10 %
Repetition accuracy (with constant parameters)	± 0.5 %
Variation according to VDE 0435	0 +40 °C : ± 3 %
	-20 +60 °C : ± 5 %
Reset time during timed delay	200 ms
Reset time after timing	200 ms (SFS)
Immunity from micro power cuts	< 20 ms
Nominal current - I max at 20 °C	0.7 A
Nominal current - I min	5 mA
Maximum admissible current	20 A < 0.01 s
Leakage current at 20 °C	≤ 5 mA
Voltage drop at terminals	3.5 V
Derating	5 mA / °C
Electrical life (number of operations)	> 10 <sup>8</sup>
Weight (g)	55

### Curves

#### Function X

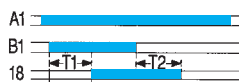

### Connections

#### SFS

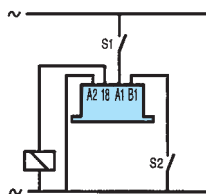

# S/SE timers

## → Compressor timer

### Solid state output

- Mono-funtion
- Mono-range-timing fixed
- Mono-voltage
- Solid state output 0.7 A at 20 °C
- Specially suitable for compressors and heat pumps
- Fully sealed for protection by encapsulation in polyurethane resin
- Connection by 6.35 mm Faston blade terminals



### Specifications

Type	Voltage	Functions	Maximum timing (to be specified or ordering)	Features	Code
SASX 88 870 8	24 V AC 50/60 Hz	ACC1 : Anti-short cycle special compressor model	10 min	Fixed timing	•
	48 V AC 50/60 Hz	ACC1 : Anti-short cycle special compressor model	10 min	Fixed timing	•
	110 V AC 50/60 Hz	ACC1 : Anti-short cycle special compressor model	10 min	Fixed timing	•
	230 V AC 50/60 Hz	ACC1 : Anti-short cycle special compressor model	10 min	Fixed timing	•
SASC 88 870 0	24 V AC 50/60 Hz	ACC2 : Anti-short cycle special compressor model	10 min	Fixed timing	•
	48 V AC 50/60 Hz	ACC2 : Anti-short cycle special compressor model	10 min	Fixed timing	•
	110 V AC 50/60 Hz	ACC2 : Anti-short cycle special compressor model	10 min	Fixed timing	•
	230 V AC 50/60 Hz	ACC2 : Anti-short cycle special compressor model	10 min	Fixed timing	•
SASCB 88 870 6	24 V AC 50/60 Hz	ACC3 : Anti-short cycle special compressor model	180 s - 240 s - 330 s	Fixed timing	•
	48 V AC 50/60 Hz	ACC3 : Anti-short cycle special compressor model	180 s - 240 s - 330 s	Fixed timing	•
	110 V AC 50/60 Hz	ACC3 : Anti-short cycle special compressor model	180 s - 240 s - 330 s	Fixed timing	•
	230 V AC 50/60 Hz	ACC3 : Anti-short cycle special compressor model	180 s - 240 s - 330 s	Fixed timing	•

### General characteristics

Accuracy	88 870 8 / 88 870 0 : ± 10 % 88 870 6 : ± 30 %
Repetition accuracy (with constant parameters)	88 870 8 / 88 870 0 : ± 0.5 % 88 870 6 : ± 4 %
Variation according to VDE 0435	0 +40 °C 88 870 8 / 88 870 0 : ± 3 % 0 +40 °C 88 870 6 : ± 10 %
Reset time during timed delay	88 870 8 / 88 870 0 : 100 ms
Reset time after timing	25 ms
Immunity from micro power cuts	< 20 ms
Nominal current - I max at 20 °C	0.7 A
Nominal current - I min	10 mA
Maximum admissible current	20 A < 0.01 s
Leakage current at 20 °C	≤ 6 mA
Voltage drop at terminals	88 870 8 / 88 870 0 : 3.5 V, 88 870 6 : 8 V
Derating	5 mA / °C
Electrical life (number of operations)	> 10 <sup>8</sup>
Weight (g)	60

### Curves

#### Function ACC1



#### Function ACC2



#### Function ACC3



### Connections

#### SASX

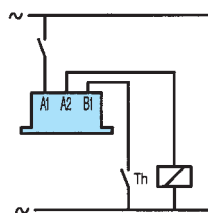

#### SASC

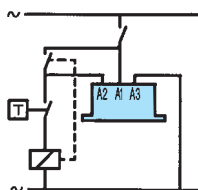

#### SASCB

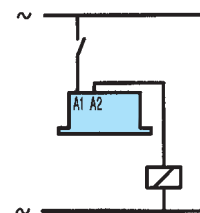

To order, see page 6. Dimensions see page 61.

## Accessories

TRPe compatible potentiometer for remote setting of timing period

Code

79 238 250

## Dimensions

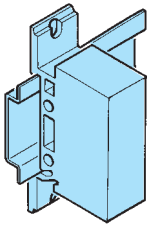

Mounting on symmetrical DIN rail EN 50022

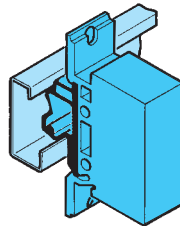

Mounting on symmetrical DIN rail EN 50043 with accessory : 26 882 591

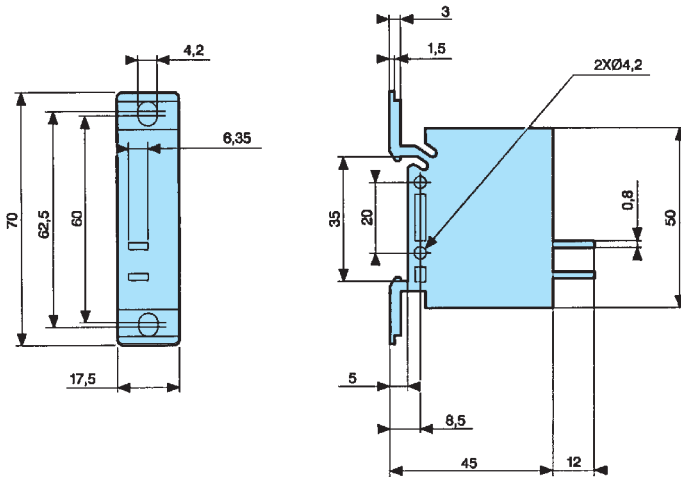

## Function and use

Protection against voltage surge	+ 1400 V ≤ 100 μs
Temperature limit operation (°C)	-20 → +60
Temperature limits stored (°C)	-25 → +70
Insulation according to standard VDE 0110 group C	250 V
Approvals in progress UL - CSA	•
Conformity VDE 045 2021	•
Protection rating	IP40
Connection : Faston 6.35 mm	•
Mounting : on symmetrical DIN rail 35 mm (EN 50022) and on panel by 2 x M4 screws	•

## Other information

Non stocked, minimum order quantity 100 units

# Defrost relay for air conditioning and industrial refrigeration

## → NFR

- Frost formation monitored by temperature probe.
- Choice of defrosting time.



## Specifications

Type	Code
NFR	88 899 204

## General characteristics

Supply voltage	90 → 260 V AC 50/60 Hz
Maximum frequency variations	± 1 Hz
Choice of total compressor operating time before defrosting (using switch on underside of unit)	25 min, 50 min, 75 min, 90 min
Defrosting time	10 min ± 10 %
Temperature 01	-3 °C
Temperature 02	+18 °C
Probe	KTY - 1 kΩ
Length of temperature probe cable	1.6 m
Absorbed power	36 VA
Weight (g)	155
Relay outputs	1 changeover
Type of contacts	AgNi - cadmium-free
Breaking capacity	2000 VA AC resistive ; 80 W
Maximum breaking current	8 V AC DC
Minimum breaking current	10 mA AC DC
Max. breaking voltage	250 VAC
Electrical life (number of operations)	10 <sup>5</sup> at 2000 VA resistive
Mechanical life (operations)	20 x 10 <sup>5</sup>
Terminals	faston type 6.35 mm
Temperature limits (use) according to IEC 62.2.14 - Casing	0 → +55 °C
Temperature limits (use) according to IEC 62.2.14 - Probe	-20 → +70 °C
Relative humidity (acc. to IEC 68.2.30)	93 %
Temperature limits (stored) for casing and probe acc. to IEC 68.2.1/2	-25 → +70 °C
Degree of protection (IEC 529) Front face	IP 20
Protection (IEC 529) Housing	IP 40
Electromagnetic compatibility	IEC 255.22.1 class III IEC 1000.4.2/3/4/5/6 level 3 IEC 1000.4.II EN 55022 class B
Breakdown voltage according to IEC 255-5	2.5 kV AC / 1 min / 1 mA / 50 Hz
Insulation resistance (IEC 255.5)	< 100 M Ω at 500 V DC
Shock resistance according to IEC 664-1/225.5 with the unit switched off	5 kV / wave 1.2 / 50 μs
Insulation coordination	IEC 664-1

## Dimensions

### NFR

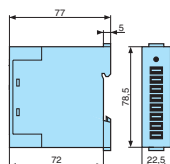

### Mounting on DIN rail

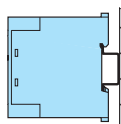

### on panel using 2 M4 screws

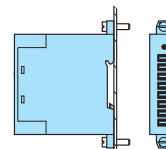

## Connections

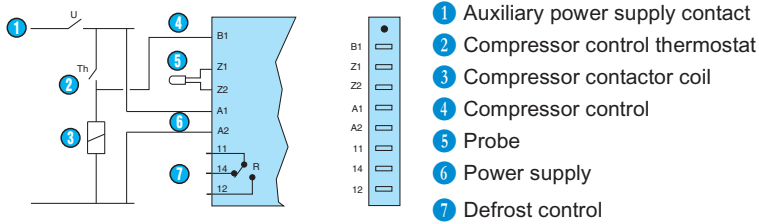

## Principles

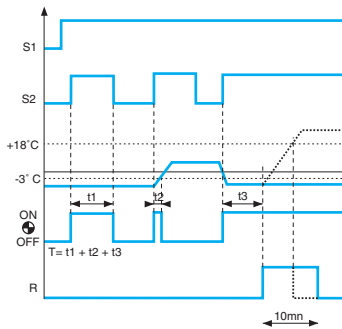

### Operating principle

The NFR defrost relay can be used to optimize the operation of the exchanger in air-conditioning or refrigeration unit.

Compact in size, and with IP20 protection, it is easy to install using screws or by fixing on a DIN rail. The temperature probe supplied with the NFR relay can be disconnected, and should be placed on the exchanger.

The standard length of the cable between the probe and the NFR relay is 1.6 m. Other lengths are available to order depending on quantity.

With a choice of different defrosting times, the unit is easily adapted to the particular installation conditions.

### Operating mode

In an air-conditioning system, when the surface temperature of the exchanger between the cooling fluid and the air is too low, frost forms on the surface and the exchanger performs less efficiently. Defrosting is then necessary by reversing the cycle or using heating resistors.

When the the total operating time of the set reaches time T (eg : 50 min) while the surface temperature of the exchanger is below 01 (- 3 °C) , the defrost cycle is determined as time t (10 min). The defrost cycle stops before the end of this time period if the temperature of the cold exchanger exceeds 02 (18 °C).

If pressed for more than 2 seconds, the button on the top initiates a defrost cycle (if the probe temperature is below 18 °C). This stops automatically at the end of 10 minutes or immediately if one of the power supply wires (terminals A1 or A2) or probe wires (terminals Z1 or Z2) is disconnected momentarily.

# DIN rail mounted

## → TOP 2000

- Multi-function
- Multi-range
- Mono-voltage
- 1 timed changeover + 1 instantaneous contact
- Elapsed time can be saved mechanically in the event of a break in supply
- Progress of a cycle displayed
- Housing for DIN rail mounting



### Specifications

Type	Relay outputs	Functions	Voltage	Code
6 s - 12 min	1 timed changeover 5 A 1 instantaneous	Multi-function : 2 - 3 - 4	24 V AC	88 225 013
			42 → 48 V AC	88 225 019
			110 → 127 V AC	88 225 012
			220 → 240 V AC	88 225 011
6 min - 12 h	1 timed changeover 5 A 1 instantaneous	Multi-function : 2 - 3 - 4	24 V AC	88 225 016
			42 → 48 V AC	88 225 017
			110 → 127 V AC	88 225 015
			220 → 240 V AC	88 225 014

### Options

	Code
Inverter for DC supply 24 - 48 V	84 861 501
Inverter for DC supply 110 . 127 V	84 861 503

### Dimensions

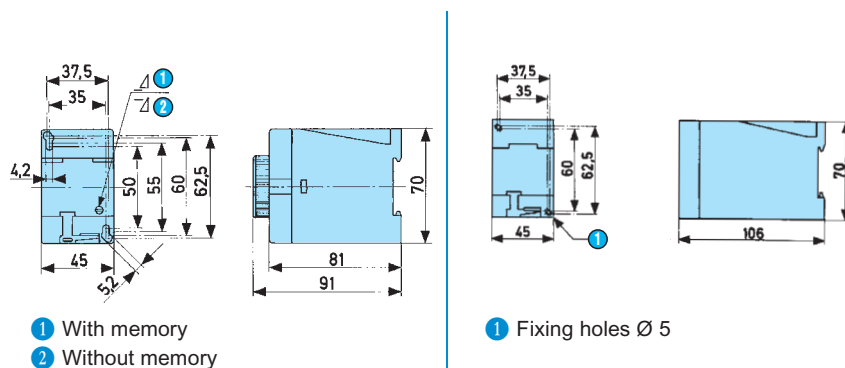

To order, see page 6



## General characteristics

### Precision

Precision limit error	±2 % (±5 % / 6 s)
Repetition accuracy	±1.5 % (±4 % / 6 s)
Reset time	0.20 s

### Output specification

Timed two-pole	1
Instantaneous single pole	1
Thermal rating	6.3 A
Rating (cos φ = 0.41) 10 <sup>4</sup> operations	5 A - 230 V

### Function and use

Voltage variation at maximum temperature of 55 °C according to IEC 255 100	24 V +10 % - 42 V -15 % - 48 V +10 % - 110 V -20 % - 127 V 0 % - 220 V - 20 % - 240 V 0 %
Absorbed power-motor	3 VA cos μ 0.7
Operator factor	100 %
Temperature limit operation (°C)	-10 → +55 °C
Temperature limits stored (°C)	-20 → +70 °C
Environmental protection Tropicalised to IEC 68-2-10	•
Vibration withstand on 3 axes (Veritas standard)	4 G - 55 Hz
Dielectric test voltage according to IEC 255 5 or VDE 0435	1000 V - Un ≤ 60 V 2000 V - Un > 60 V
Insulation according to standard VDE 0110 group C	380 V AC - 440 V DC
Protection Housing	IP 40
Protection Terminal	IP 10
Conformity to standards NFC 45250 - VDE 0110 - 0435 - 0660 or ICE 255 - 1 - 00	•
Connection : By screws in front face with self-lifting grips	•
Terminal capacity Single-wire	(1-2) x 0.75 - 2.5 mm <sup>2</sup>
Terminal capacity : Multi-wire with self-crimping ferrules	(1-2) x 0.75 - 2.5 mm <sup>2</sup>
Mounting by screw	2 x M5
Mounting : on symmetrical DIN rail 35 mm (EN 50002)	•
Weight (g)	185

## Connections

### Function 2

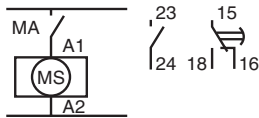

### Internal layout

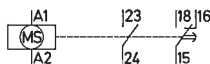

### Function 3

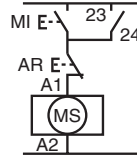

### Terminal identification

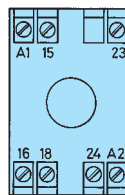

A1 - A2 : Supply  
15 - 16 - 18 Timed contact  
23 - 24 Instantaneous contact

### Function 4

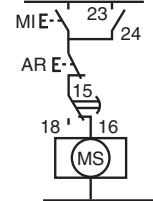

Function 4 : On energisation, chance of contact bounce on instantaneous contact for 250 ms

## Curves

### Function 2

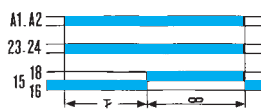

### Function 3



### Function 4



## Other information

For 60 Hz frequency please consult us

## Standards and approvals

Our timers are designed according to international recommendations (IEC), American (UL), Canadian (CSA) and German (VDE) standards, European standards (EN), etc.





Proof of compliance with these standards and recommendations is demonstrated by approval (a symbol or certificate of conformity granted by an accredited body) or by the manufacturer's declaration of conformity (drafted in accordance with ISO/IEC 22 guidelines).

We have indicated the principal approvals so far obtained in the table below. Conformity to standards is indicated in the "technical characteristics".

## Machine safety

Our products are compatible with standard EN 60204-1 (IEC 201-1) concerning the safety of electrical equipment for machinery.

## Approval markings

National approvals				Conformity	
		UL			
Switzerland	Canada	United States		France	Germany
					

# Panel mounted Timers



	Function	Output	Voltage	Connection	Designation	Rated current	Timing		
<b>MONO-FUNCTION</b>	<b>A</b>	2 relays	12 to 240 VDC	8-pin	TMR 48 A	5 A	0.02 s to 300 h	<b>Page 74</b>	
			24 to 240 VAC						
			24 VAC/DC						
			110 VAC						
				220 to 240 VAC		TIMER 812 LCD display		0.01 s to 9999 h	<b>Page 82</b>
	Solid state	100 to 240 VAC/DC	Screw terminals	MBA 2F 22 mm	400 mA	0.1 s to 1 s	<b>Page 90</b>		
						0.5 s to 10 s			
						3 s to 60 s			
						0.5 min to 10 min			
						3 min to 60 min			
					0.1 s to 1 s				
					0.5 s to 10 s				
					3 s to 60 s				
					0.5 min to 10 min				
					3 min to 60 min				
<b>MULTI-FUNCTION</b>	A-B-C-W-G-Ac-Bw	2 relays	12 to 240 VDC	11-pin	TMR 48 U	5 A	0.02 s to 300 h	<b>Page 74</b>	
			24 to 240 VAC						
	A1-A2-H1-H2-Q1-Q2-D-Di	2 relays	12 to 240 VDC	8-pin	TMR 48 X	5 A	0.02 s to 300 h	<b>Page 74</b>	
			24 to 240 VAC						
	L-Li-G-Gi	2 relays	12 to 240 VDC	8-pin	TMR 48 L	5 A	0.02 s to 300 h	<b>Page 74</b>	
			24 to 240 VAC						
	A-Ab-B-C D-Di-H-T	1 relay	12 VDC / 24 VDC	11-pin	TOP 948 LCD display	5 A	0.01 s to 999.9 h	<b>Page 78</b>	
			24 VAC / 42 to 48 VAC						
			100 to 127 VAC / 220 to 240 VAC						
	A-B-C D Di-H	1 relay	12 VDC / 24 to 48 VAC/DC	8-pin	TIMER 814 LCD display	8 A	0.01 s to 999.9 h	<b>Page 82</b>	
			24 VAC/DC / 110 to 240 VAC	11-pin					
			24 VAC/DC / 48 VAC/DC	8-pin	TIMER 816 LCD display				
			24 VAC/DC / 110 VAC	11-pin					
			24 VAC/DC / 220 to 240 VAC	8-pin					
				11-pin					
A1-A2-AM AMt	2 relays	12 VDC / 24 to 48 VAC/DC	11-pin	TIMER 814 LCD display	8 A	0.01 s to 999.9 h	<b>Page 82</b>		
		24 VAC/DC / 110 to 240 VAC	8-pin						
		12 VDC / 42 to 48 VAC/DC	11-pin	TIMER 815 LCD display					
		24 VDC / 220 to 240 VAC							
		24 VAC/DC / 110 VAC							



TIMER 812



MBA



TMR 48



TOP 948



TIMER 816

3

Function	Output	Voltage	Designation	Rated current	Model	Max. display time
MONO-FUNCTION  <b>A</b>	1 relay	127 VAC / 230 VAC	88 256 4 Single-pole Manual reset	16 A	5 min	4 min 40 s
					15 min	14 min
					30 min	28 min
					60 min	56 min
					120 min	1 h 53 min
					5 h	4 h 43 min
					15 h	14 h 10 min
	2 relays		88 256 5 Two-pole Manual reset		5 min	4 min 40 s
					15 min	14 min
					30 min	28 min
					60 min	56 min
					120 min	1 h 53 min
					5 h	4 h 43 min
					15 h	14 h 10 min
	3 relays		88 256 9 Three-pole Manual reset		30 h	28 h 20 min
					5 min	4 min 40 s
					15 min	14 min
					30 min	28 min
					60 min	56 min
					120 min	1 h 53 min
					5 h	4 h 43 min
		15 h	14 h 10 min			
		30 h	28 h 20 min			



88 256 4 series

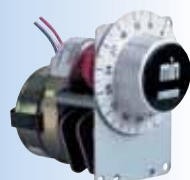

88 256 5 series



88 256 9 series

Page 96

Function	Output	Voltage	Designation	Rated current	Timing	Connection
MULTI-FUNCTION	1 relay	24 VAC	TOP 2000 48 x 48	5 A	6 s to 12 min	Screw terminals
					6 min to 12 h	8-pin
		42 to 48 VAC			6 s to 12 min	Screw terminals
					6 min to 12 h	8-pin
		110 to 127 VAC			6 s to 12 min	Screw terminals
					6 min to 12 h	8-pin
		220 to 240 VAC			6 s to 12 min	Screw terminals
					6 min to 12 h	8-pin
					6 s to 12 min	Screw terminals
					6 min to 12 h	8-pin



TOP 2000

Page 92

# Basic principles

## Timers

A timer is a control component which, after a preset time, energises an output contact. The start of a timing cycle, single or repetitive, is produced by timer energisation or by maintained or pulse control contacts with, as a result, a large number of potential functions. There are two types of presentation:

### → DIN rail mounted

Product designed for mounting within a control panel.

### → Panel-mounted

Product designed to be fitted on a panel in order to be accessible by the user.

There are two types of output:

**Timed contacts** dependent on the value of the set time.

**Instantaneous contacts** operating simultaneously with the energisation or de-energisation of the product in instantaneous fashion (excluding certain cases, for example: memory).

### → Note:

Electro-mechanical timers with automatic reset are fitted with:

- either a standard clutch : during timing, the electro-clutch is energised
  - or a reversed clutch : during timing the electro-clutch is de-energised.
- Timers with manual reset require "manual" intervention for the commencement of a new cycle which involves resetting the timing selector.

## Definitions

### → Minimum control contact time

This is the minimum pulse time required to effect timing control.

### → Reset time (or return)

This is the time required at the end of a cycle for resetting the timer to start a new cycle.

### → Accuracy

This is the maximum difference between the selected and the actual timing of the cycle chosen.

It is expressed as a percentage of the maximum value of the timing range considered within normal operating parameters.

### → Maximum operating current

This is the maximum uninterrupted current at which the timer may function permanently within normal operating parameters when the timer contact is closed.

### → Thermal intensity

Current limit in continuous duty for a circuit with the highest possible level of current which a previously closed contact circuit can tolerate at all times in specified conditions.

### → Contact rating

This is the value of the current that can be switched by a contact in certain specified conditions.

### Insulation to standard VDE 110 group C, IEC 255.5 and IEC 664

Spécifications pour le dimensionnement des lignes de fuite et distance dans l'air du matériel électrique.

### → Protection

To IEC 529: classification of the levels of protection obtained by casings, terminal

- against solid matter
- against liquids

### → Protection from voltage surge

This protection is designed to eliminate voltage peaks generated by the industrial environment. It is generally provided by a varistor, the capacity of which is expressed in joules.

Example:

2 joules = 5000V x 400 A x 1µs

For circuits with strong electrical interference (over 2 joules) the user should ensure adequate protection.

### → Electromagnetic compatibility

Electromagnetic compatibility tests measure the degree of immunity which a piece of equipment shows to various types of disturbance as defined in IEC standards.

## Controls

### → Quality control

Our products are quality controlled systematically during assembly and on completion. The overseeing of control checks in the workshop, the use of collected data and any resulting product assessments form the essential role of Quality Control. All our products undergo a final check, either 100% or on a selective basis according to French standard X 06-022, which provides for a classification of possible defects in three groups : critical, major, minor.

### → Note:

According to customer requirements and for certain product ranges which must meet particular requirements expressed in a specification, it is always possible to create or to modify a quality standard on the basis of a normal or special existing product and to vary the level of inspection. It can happen that the tolerance level is set at zero for certain parameters directly linked to the completion of a function for which total success must be assured: a defect is therefore fatal. Such specific requirements do, however, entail a significant increase in product costs.

## Standards and approvals

Our timers are designed according to international recommendations (IEC), American (UL), Canadian (CSA) and German (VDE) standards, European standards (EN), etc.





Proof of compliance with these standards and recommendations is demonstrated by approval (a symbol or certificate of conformity granted by an accredited body) or by the manufacturer's declaration of conformity (drafted in accordance with ISO/IEC 22 guidelines).

We have indicated the principal approvals so far obtained in the table below. Conformity to standards is indicated in the "technical characteristics".

## Machine safety

Our products are compatible with standard EN 60204-1 (IEC 201-1) concerning the safety of electrical equipment for machinery.

## Approval markings

National approvals				Conformity	
		UL			
Switzerland	Canada	United States		France	Germany
					

# FUNCTIONS

U : Supply  
 R : Output or load relay  
 T : Timing  
 C (Y1) : Control contact  
 ∞ : indefinite

## → Function A : Delay on energisation

Single timing cycle which begins on energisation.

The output changes state after timing.

2 relays timed or  
 1 relay timed and 1 instantaneous

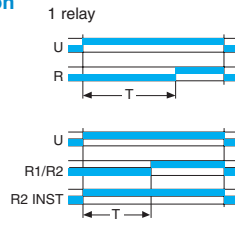

## → Function B : Timing on impulse one shot On pulse (with constant supply)

After energisation; a pulse ( $\geq 50$  ms) or a maintained control contact will cause the output to change state which reverts to the rest position at the end of timing.

**N.B.** : this process enables shortening or lengthening of a signal.

2 relays timed or  
 1 relay timed and 1 instantaneous

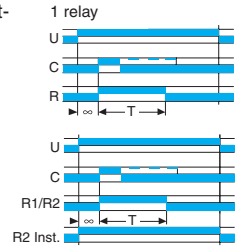

## → Function Ab : One-shot cycle

The output changes states at the end of the set time T1, for a period T2.

Both T1 and T2 independently adjustable.

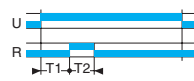

## → Function Ac : Timing after closing and opening of control contact

After energisation, closure of the control contact causes the timing period T to commence and output relay R (or the load) changes state at the end of this interval. When contact C (Y1) opens, relay R resets after a second timing period T.

2 relays timed or  
 1 relay timed and 1 instantaneous

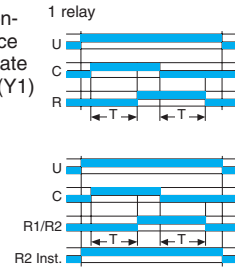

## → Function Bw : Pulse output (adjustable)

A output relay R (or the load) changes state, and remains in the changed-over state for the timing period, both when control contact C (Y1) closes and when it opens.

2 relays timed or  
 1 relay timed and 1 instantaneous

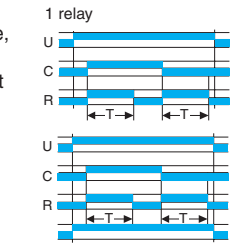

## → Function Ad : Delay on energisation by switch (not resettable)

After power-up, pressing or holding down the switch starts timing. At the end of timing, the output is energised. The output will be reset the next time the switch is pressed or held down.

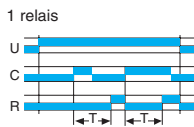

## → Function Ah : Flashing single cycle by switch (not resettable)

After power-up, pressing or holding down the switch starts timing. At the end of timing, the output is energised. At the end of this second timing, the output falls back to its initial value.

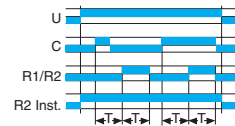

## → Function At : Timing on energisation with memory

Provides a cumulative time for contact opening.

The output changes states at the end of the set time.

2 relays timed or  
 1 relay timed and 1 instantaneous

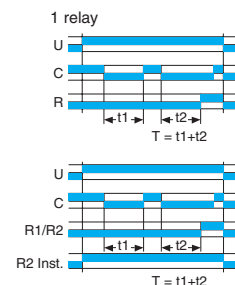

## → Function C : Timing after impulse Delay OFF (with constant supply)

After energisation, once the control contact is closed the output state changes.

Timing will only begin on the re-opening of this control contact (one shot).

Relay R returns to its initial position at the end of the timing period.

2 relays timed or  
 1 relay timed and 1 instantaneous

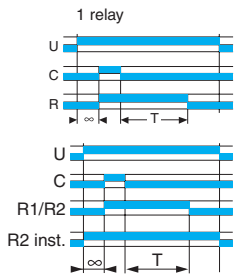

## → Function D ou Di : Flip-flop

Repetitive cycle which switches the output alternately between the rest and operating position for equal time bases.

$T1 + T2 = T$  total

**Function D:** the cycle begins with the output in rest position. Pause start.

2 relays timed or  
 1 relay timed and 1 instantaneous

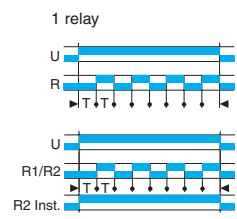

**Function Di:** the cycle begins with the output in the operating position. Pulse start.

2 relays timed or  
 1 relay timed and 1 instantaneous

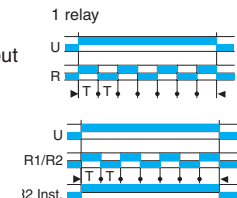

## → Function H : Timing on energisation Interval timer - one shot

On energisation, the output changes state, remains in that state for the duration of timing and resets at the end of the single cycle.

**N.B.** This is complementary to function A.

2 relays timed or  
 1 relay timed and 1 instantaneous

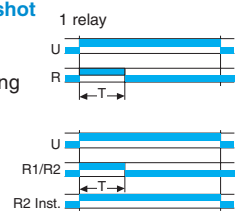

3



→ **Function Ht : Delay on energisation with memory**

Provides a cumulative time for contact opening. On energisation, the output changes state, remains in that state for the duration of timing and resets at the end of the single cycle.

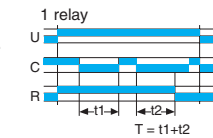

2 relays timed or  
1 relay timed and 1 instantaneous

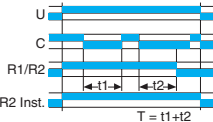

→ **Function K : Delay on de-energisation - True delay OFF**

On energisation, the output changes state. On de-energisation timing commences and the output only returns to the reset condition after timing.

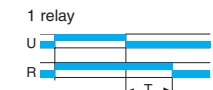

2 relays timed or  
1 relay timed and 1 instantaneous

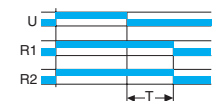

→ **Function L : Cyclic timing - Asymmetrical recycler**

Repetitive cycle comprising 2 independent adjustable time bases. Each time base corresponds alternately to a different output state.

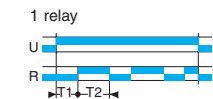

**N.B. :** The cycle starts with the output in the rest position.

2 relays timed or  
1 relay timed and 1 instantaneous

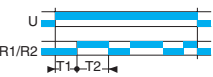

→ **Function Li : Cyclic timing - Asymmetrical recycler**

Repetitive cycle comprising 2 independent adjustable time bases. Each time base corresponds alternately to a different output state.



**N.B. :** The cycle starts with the output in the operating position.

2 relays timed or  
1 relay timed and 1 instantaneous



→ **Function N : "Safe-guard"**

At the first control pulse the output is energised. To complete the timing the interval between the two control pulses must be greater than the timing set.

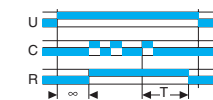

→ **Function O : "Delayed safe-guard"**

On energisation, a first timing sequence occurs and the output changes state. With the closing of the control contact, the output resets and the timing starts, with the output being activated after timing. For the timing to be completed, the interval between the closing of two control contacts must be greater than the timing set.

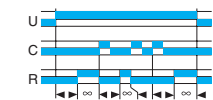

→ **Function P : Delayed fixed-length pulse**

Timing begins on energisation. At the end of the timing period output relay R (or the load) changes state for a period of approx. 500 milliseconds.

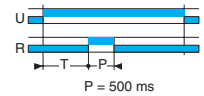

→ **Function Pt : Impulse counter (delay on)**

Calculates the total opening time of a contact. At the end of timing, the output is energised for approximately 500 ms.

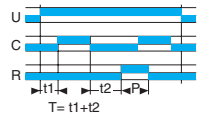

→ **Function Q : "Star-delta"**

At the end of timing, the output is not energised. It remains "open" (not conducting) and will only change state after the fixed time of Ti has elapsed. Dwell time selectable

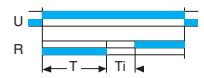

→ **Function T : Timing on energisation with memory**

**a - energisation by control signal**  
The timer sums the times for which the control contact is closed (C1). Reset is by the reset signal (C2) only.

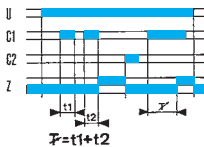

**b - energisation by supply voltage**  
The timer sums the times for which the supply voltage (U) is on. Reset is by the reset signal (C2) only

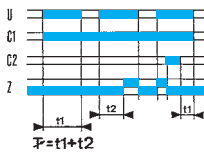

→ **Function T : Impulse relay**

After power-up, pressing or holding down the switch closes the relay. Pressing the switch a second time opens the relay.

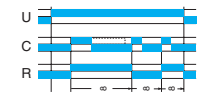

→ **Function Tt : Timed impulse relay**

After power-up, pressing or holding down the switch closes the relay and starts timing. The relay opens at the end of timing or when the switch is pressed a second time.

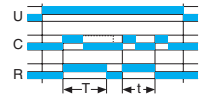

→ **Function W : Timing after pulse on control contact**

After energisation, if the control contact opens it causes output relay R (or the load) to change state and timing to start. At the end of the timing period, relay R resets to its original state.

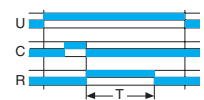

# Analogue TMR 48

## → TMR 48

- Multi-function or mono-function
- Multi-range from 0.02 s to 300 h
- Multi-voltage 12 to 240 VDC / 24 to 240 V AC
- Time setting displayed on dial
- 2 changeover relays 5 A / 250 VAC
- Display of power and output states by 2 LEDs
- Housing 48 x 48 mm



### Specifications

Type	Functions	Relay outputs	Max. breaking current	Supply voltage	Connection	Code
TMR 48 U	A, B, C, W, G, Ac, Bw	2 timed changeover	5 A / 250 VAC	12 → 240 VDC 24 → 240 VAC	Plug-in 11 way	88 886 016
TMR 48 A	A	2 timed changeover	5 A / 250 VAC	12 → 240 VDC 24 → 240 VAC	Plug-in 8 way	88 886 106
TMR 48 X	A1, A2, H1, H2, Q1, Q2, D-Di	2 changeover or 1 timed and 1 instantaneous	5 A / 250 VAC	12 → 240 VDC 24 → 240 VAC	Plug-in 8 way	88 886 116
TMR 48 L	L, Li, G, Gi	2 timed changeover	5 A / 250 VAC	12 → 240 VDC 24 → 240 VAC	Plug-in 11 way	88 886 516

### Accessories

	Code
11-pin connector base	25 622 080
8-pin connector base	25 622 130
Spring clips (packet of 2)	79 237 740
Black front face. For grey and other colours	please consult us

### General characteristics

Supply voltage Un	12 → 240 VDC 24 → 240 V AC
Operating range	± 10 % DC supply - 15 % / + 10 % AC supply
Frequency	50 / 60 Hz
Power consumption	4.8 VA / 230 VAC 2.5 VA / 110 VAC 1.1 VA / 24 VAC 0.5 W / 24 VDC 0.8 W / 12 VDC
Timing ranges (14 available options)	0,02 → 1,2 s    0,2 → 12 min.    0,2 → 12 h 0,05 → 3 s    0,5 → 30 min.    0,5 → 30 h 0,2 → 12 s    2 → 120 min.    2 → 120 h 0,5 → 30 s    5 → 300 min.    5 → 300 h 2 → 120 s 5 → 300 s
Repetition accuracy	± 0.5 % of full scale at 25°C (typical with constant parameters)
Temperature drift according to CEI/EN 61812	± 0.05 % of full scale
Display accuracy	± 5 % of full scale at 25°C
Minimum pulse duration START	25 ms
Minimum pulse duration GATE	60 ms
Minimum pulse duration RESET	60 ms
Start-up delay after power cut (START linked)	50 ms
<b>Output specification</b>	
Nominal rating	2 x 5 A
Nominal insulation voltage	250 VAC
Rated power (resistive load)	2000 VA
Minimum current	10 mA
Electrical life at I max. 250 V AC resistive (number of operations)	10 <sup>5</sup>
Mechanical life (operations)	30 x 10 <sup>6</sup>
<b>Function and use</b>	
Display of output state by 2 LEDs	Green : power ON, flashing during timing Yellow : ON output ON, OFF output OFF
Operating temperature range (°C)	-20 → +55
Storage temperature range (°C)	-40 → +70
Breakdown voltage	2 KV
Protection class (IEC 60529) - Panel-mounted	IP 50
Protection class (IEC 60529) - Casing	IP 40
Material housing	self-extinguishing
Weight (g)	140

To order, see page 6

## Dimensions

### TMR 48 U / A / X / L

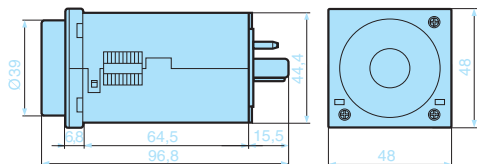

### Connector base - 25 622 080 - 25 622 130

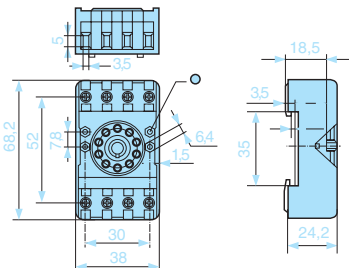

### Panel cut-out

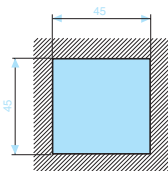

## Connections

### TMR 48 U

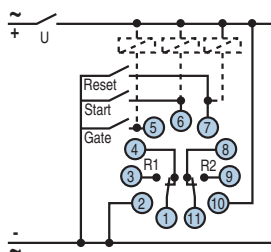

### TMR 48 A

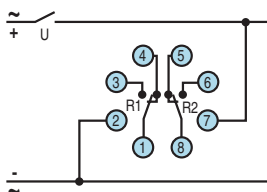

### TMR 48 X

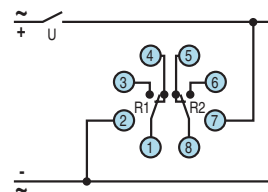

### TMR 48 L

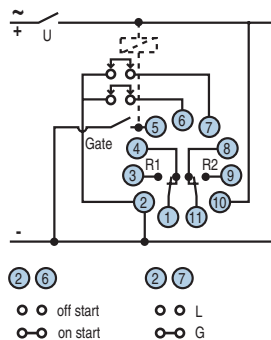

## Curves

### Function A (TMR 48 A) Delay on energisation

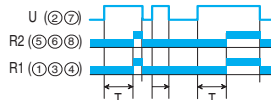

### Function A1 Delay on energisation

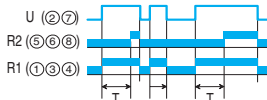

### Function A2 Delay on energisation

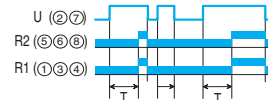

### Function H1 Timing on energisation

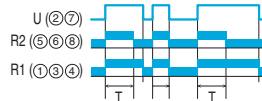

### Function H2 Timing on energisation

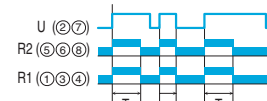

### Function Q1 Star-delta

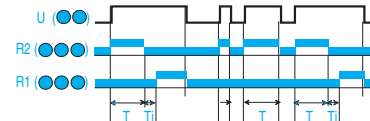

**Function Q2  
Star-delta 2**

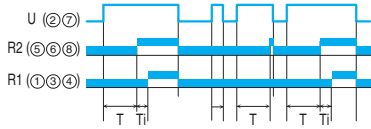

**Function D-Di  
Cyclic timing : symetric recycler**

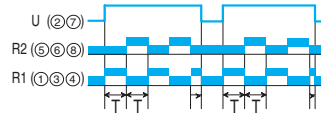

**Function A (TMR 48 U)  
Delay on energisation**

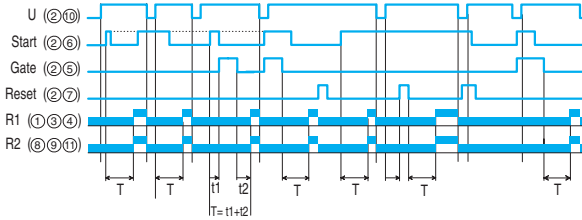

**Function B  
Timing on impulse**

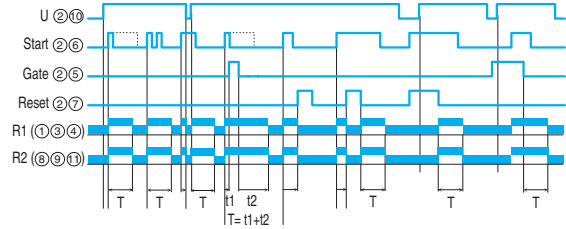

**Function C  
Timing after impulse- Delay off with constant supply**

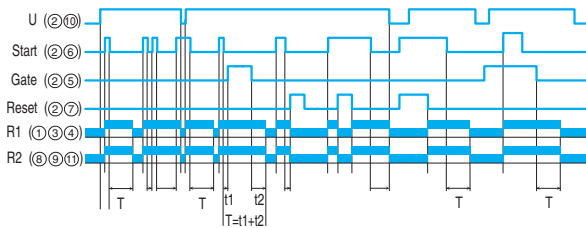

**Function W  
Timing after impulse on control contact**

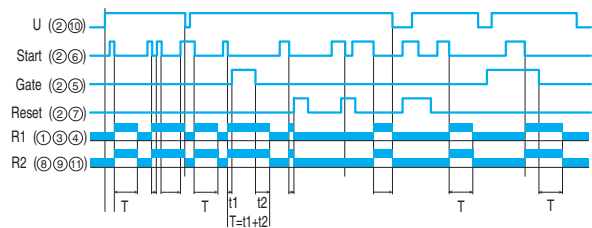

**Function G  
Cyclic function**

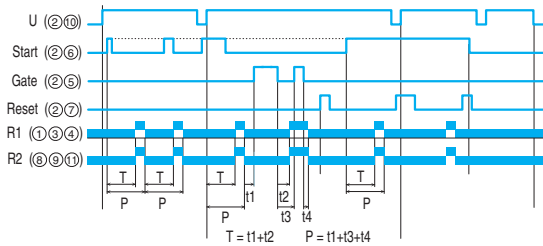

**Function Ac  
Timing after closing and opening of control contact**

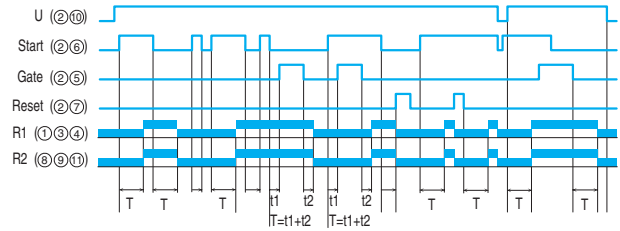

**Function Bw  
Pulse output (adjustable)**

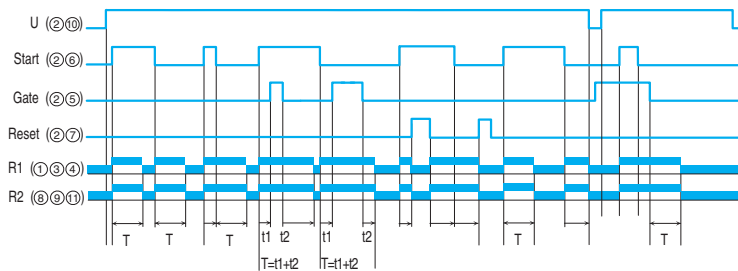

**Function L/Li - G/Gi  
Cyclic timing : asymetrical recycler**

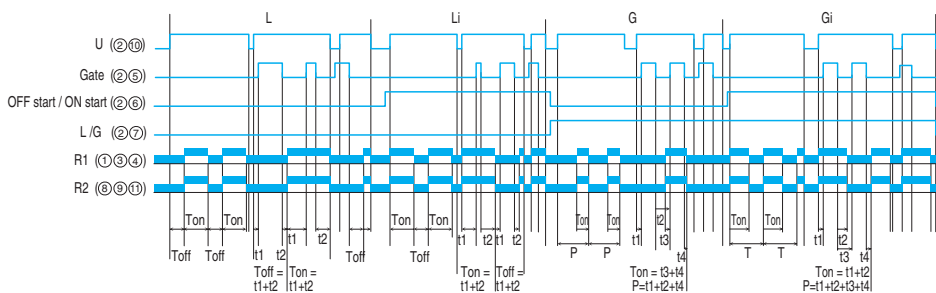



# TOP 948 digital timers

## → TOP 948

### Relay output digital timer

- Multi-voltage (voltage range)
- 1 changeover relay
- Elapsed time can be saved in the event of a break in supply
- Optional locking via keyboard of Reset key and access to timing values
- Connection by 11-pin base
- Housing 48 x 48 mm



### Specifications

Type	Functions	Relay outputs	Supply voltage	Nominal rating	Code
TOP 948	A - Ab - B - C - D - Di - H - T	1 timed changeover	12/24 V DC	5 A AC	88 857 502
	A - Ab - B - C - D - Di - H - T	1 timed changeover	24 / 42.48 VAC	5 A AC	88 857 504
	A - Ab - B - C - D - Di - H - T	1 timed changeover	110.127/220.240VAC	5 A AC	88 857 508

### Accessories

	Code
11-pin connector socket	25 622 077
11-pin rear base	79 694 002
11-pin solder-connected plug	25 622 076
Asymmetrical adaptor	79 694 005
Spring clips	79 237 790

### Dimensions

#### Panel cut-out

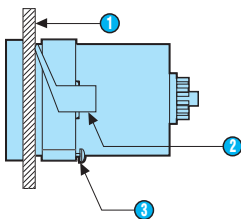
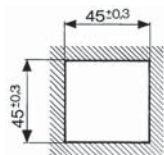

- 1 Panel thickness 1 to 3.5 mm
- 2 Clip for panel-mounting
- 3 Positioning screw

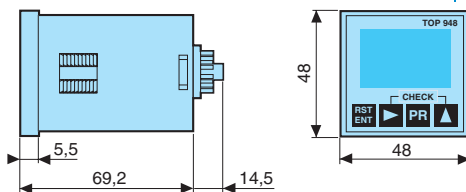

#### 11-pole rear base

79 694 002

Panel-mounted

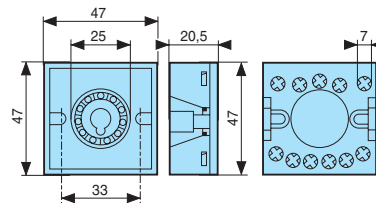

#### 11-pin connector socket

25 622 077

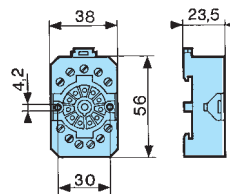

#### 11-pin solder-connected plug

25 622 076

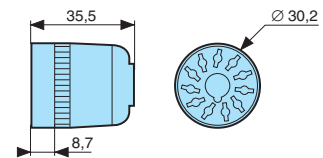

## General characteristics

### Display

Number of digits	4
Height of digits	8 mm

### Precision

Timing ranges (7 programmable ranges)	99.99 s - 999.9 s - 99 min 59 s - 99.99 min - 999.9 min - 99 h 59 min - 999.9 h
Repetition accuracy (even with variation of temperature) * if start T ON	$\pm 0.005 \% \pm 20 \text{ ms}$ $\pm 50 \text{ ms}^*$
Display accuracy	$\pm 0.05 \% \pm 20 \text{ ms}$
Reset time by de-energisation	$\leq 0.05 \text{ s}$
Reset time by control contact	$\leq 0.05 \text{ s}$
Reset time by reset to zero	$\leq 0.05 \text{ s}$

### Input specification

Control and zero-reset input - By contact	•
Control and zero-reset input - Solid state PNP Level 0	0 → 1 V
Control and zero-reset input - Solid state PNP Level 1	4 → 30 V
Impedance	10 k $\Omega$ $\pm$ 10 %
Min. control pulse	50 ms

### Output specification

Nominal rating	5 A V AC 1 A V DC
Nominal insulation voltage	250 V AC DC
Maximum power rating (resistive)	1250 VA - 30 W
Electrical life at I max., 250 V AC resistive (cycles)	10 <sup>5</sup>
Mechanical life (operations)	2 x 10 <sup>7</sup>
Max. permitted number of operations per hour at 5 A 250VAC resistive	360

### Function and use

Functions and EEPROM configuration stored for (years)	10
Voltage variation	+ 10 % - 15 %
Immunity from micro power cuts	$\leq 3 \text{ ms}$
Maximum power consumption	0.5 W/12 V DC 1 W/24 V DC 1.3 VA/24 V AC 4 VA/48 V AC 8 VA/115 V AC 17 VA/230 V AC
Temperatures limits use (°C)	-10 → +50
Temperature limits stored (°C)	-25 → +70
Protection class according to NFC C 20010-IEC 529-DIN 40050 Panel-mounted	•
Insulation according to standard VDE 0110-IEC 255 group C	250 V AC DC
Breakdown voltage according to IEC 255-5	3 kV
Test on power supply (IEC-801-4 level 3)	2 kV
Test on input signal (IEC-801-4 level 3)	1 kV
Damped oscillatory wave (IEC-255-4)	3 kV
Impulse voltage (IEC 255 5)	5 kV
Electrostatic discharge on face (IEC 801-2)	15 kV
Degree of protection front face	IP 65
Mounting Front panel, by clip	•
Mounting base-mounted on socket	•
Weight (g)	100

## Connections

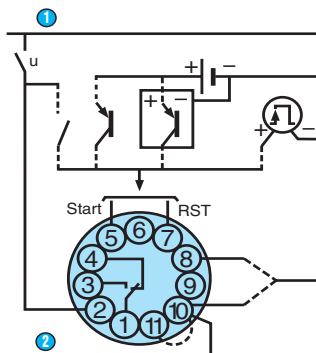

- ① VAC or + VDC
- ② VAC or + 0VDC

## Curves

### Function A

Delay on energisation

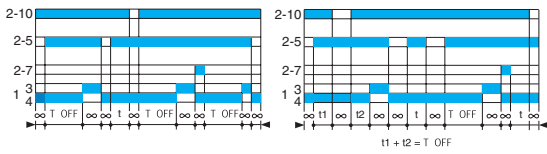

- 1 without memory
- 2 with memory

### Function B

Timing on impulse (one shot)

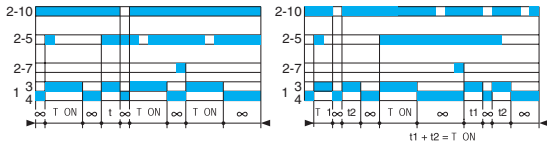

- 1 without memory
- 2 with memory

### Function Di or L

Cyclic timing

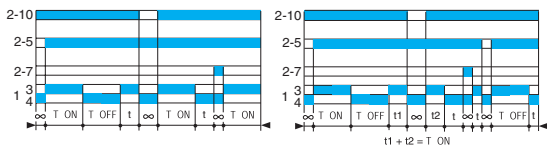

- 1 without memory
- 2 with memory

### Function H

Timing on energisation

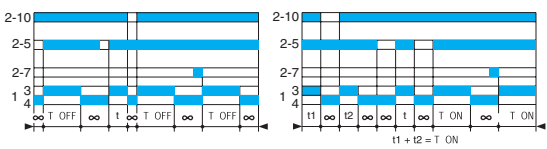

- 1 without memory
- 2 with memory

### Function Ab

Cyclic timing Single cycle

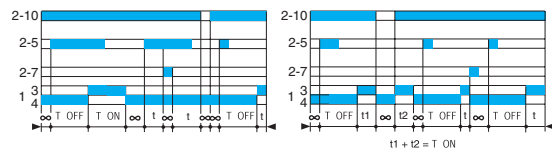

- 1 without memory
- 2 with memory

### Function C

Timing after impulse (delay off)

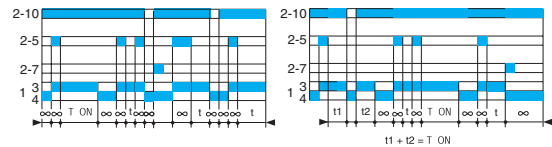

- 1 without memory
- 2 with memory

### Function D or La

Cyclic timing

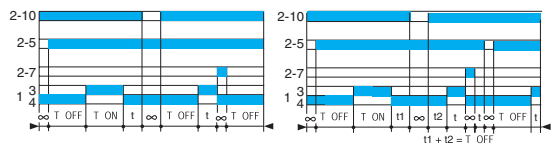

- 1 without memory
- 2 with memory

### Function T

Timing on energisation with memory  $T = t1 + t2$

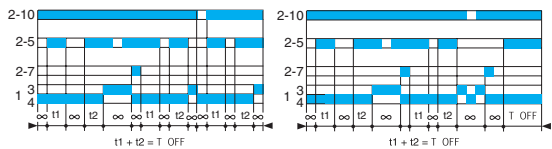

- 1 without memory
- 2 with memory

3





# 812/ 814/ 815 digital timers

## → 812 - 814 - 815

### Relay output digital timer

- Multi-range
- Multi-voltage
- 1 or 2 relay outputs
- Reset function on panel (Timers 815)
- Data saved in the event of a break in supply (Timer 815)
- Access to programming lockable (Timer 814 and 815)
- Up or down timing mode
- Internal power supply by battery (10 years / 20 °C)



### Specifications

Type	Functions	Connections	Relay outputs	Supply voltage	Nominal rating	Code
Timer 812	A	8-pin plug-in	1 double timed changeover	24 V AC DC	2 x 5 A	88 857 409
	A	8-pin plug-in	1 double timed changeover	110 V AC	2 x 5 A	88 857 406
	A	8-pin plug-in	1 double timed changeover	220 → 240 V AC	2 x 5 A	88 857 400
Timer 814	A, B, C, D, Di, H	8-pin plug-in	1 timed changeover	12 VDC/24 to 48V ACDC	8 A	88 857 003
	A1, A2, AM, AMt	11-pin plug-in	1 timed changeover or instantaneous	24 V AC/110 to 240V AC	2 x 8 A	88 857 005
	A1, A2, AM, AMt	11-pin plug-in	1 timed changeover or instantaneous	12 VDC/24 to 48V ACDC	2 x 8 A	88 857 103
	A, B, C, D, Di, H	11-pin plug-in	1 timed changeover	24 V AC/110 to 240 V AC	8 A	88 857 105
Timer 815	A1, A2, AM, AMt	11-pin plug-in	1 timed changeover or instantaneous	12 V DC / 42 to 48 V AC DC	2 x 8 A	88 857 302
	A1, A2, AM, AMt	11-pin plug-in	1 timed changeover or instantaneous	24 V AC DC / 110 V AC	2 x 8 A	88 857 307
	A1, A2, AM, AMt	11-pin plug-in	1 timed changeover or instantaneous	24 V DC / 220 to 240 V AC	2 x 8 A	88 857 301

### Accessories

	Code
Asymmetrical adaptor A	79 694 005
8-pin solder-connected plug	25 622 301
11-pin solder-connected plug	25 622 076
Spring clips	79 237 790
11-pin connector socket	25 622 077
8-pin connector socket	25 622 128
11-pole rear base	79 694 002

### Curves

#### Function A

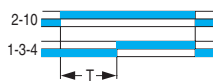

Delay on energisation 1 timed relay

#### Function A1

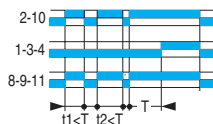

Delay on energisation 1 timed relay 1 instantaneous relay

#### Function A2

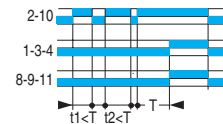

Delay on energisation 2 timed relays

#### Function AM

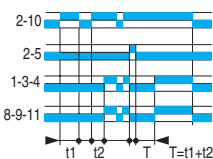

Delay on energisation Memory during and after timing. Reset

#### Function AMt

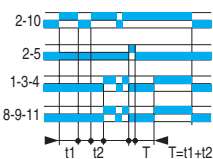

Delay on energisation Memory during timing. Reset

#### Function B

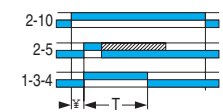

Timing on impulse (one shot)

#### Function C

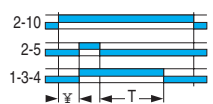

Timing after impulse (delay off)

#### Function D



Flip-flop

#### Function Di

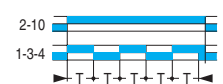

Flip-flop

#### Function H

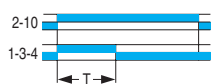

Timing or energisation

To order, see page 6

## General characteristics

### Display

Number of digits	4
Height of digits	8 mm

### Precision

Timing ranges	99 → 99 s / 999 → 9 s / 9999 s / 99 mn 59 s / 99 → 99 mn / 999 → 9 mn 9999 mn / 99 h 59 mn / 99 → 99 h / 999 → 9 h / 9999 h
Repetition accuracy (with constant parameters)	± 0.03 % ± 20 ms
Display accuracy	± 0.03 % ± 20 ms
Min. control pulse	50 ms
Maximum reset time by de-energisation during timed delay	50 ms
Maximum reset time by de-energisation after timing	50 ms

### Output specification

Nominal rating	TIMER 814 - 815 : 8 A AC 8 A DC, TIMER 812 : 5 A AC 5 A DC
Max. breaking voltage	250 AC 30 V DC
Maximum power rating (resistive)	TIMER 814-815 : 2000 VA - 190 W, TIMER 812 : 1250 VA - 120 W
Maximum admissible current	15 A < 0.01 s
Minimum current	100 mA
Electrical life at I max., 250 V AC resistive (cycles)	10 <sup>5</sup>
Max. permitted number of operations at 1 max 250 V AC resistive per hour	600
Mechanical life (operations)	5 x 10 <sup>6</sup>

### Function and use

Voltage variation	TIMER 814 : + 10 % -15 %
Immunity from micro power cuts	< 0.03 s
Max. absorbed power	0.5 W / 12 V 1 VA / 24 V 0.5 W / 24 V 3.5 VA / 110 V 1 W / 48 V 11 VA / 220 V
Temperatures limits use (°C)	-10 °C → +60 °C
Temperature limits stored (°C)	-30 °C → +70 °C
Degree of protection front face	IP65
Insulation according to standard VDE 0110-IEC 255 group C	•
Protection class according to UTE C 20010 - IEC 529 - DIN 40050	•
Conformity to standards ICE 255 - VDE 0435 - 2021	•
Mounting Front panel, by clip	•
Mounting base-mounted on socket	•
Material	Self-extinguishing UL 94 grade Vo
Weight (g)	TIMER 814 : 100, TIMER 812 - 815 : 140

## Dimensions

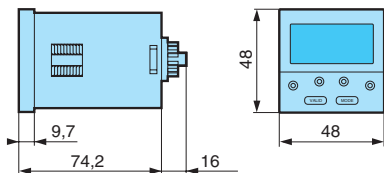

### Panel cut-out

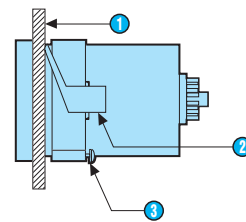
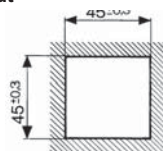

- 1 Panel thickness 1 to 3.5 mm
- 2 Clip for panel-mounting
- 3 Positioning screw

### 11-pole rear base 79 694 002 Panel-mounted

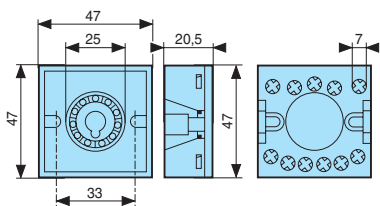

### 8-pin or 11-pin solder connected plug 25 622 301 - 25 622 076

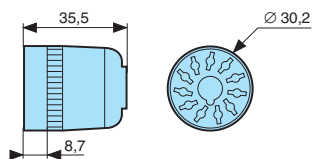

### Connector socket 11-pin 25 622 077 8-pin 25 622 128

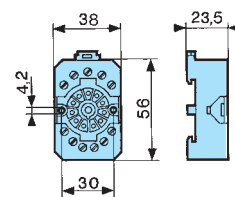

## Connections

### Timer 812 - 11-pin

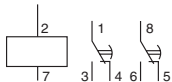

2-7 Supply  
1-3-4 Timed output contact  
8-5-6 Timed output contact

### Timer 814 - 8-pin

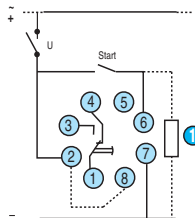

① Other loads may be connected in parallel

### Timer 815 - 11-pin

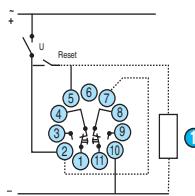

① Other loads may be connected in parallel

### Timer 812 - 8-pin

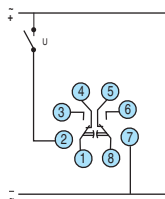

### Timer 814 - 11-pin

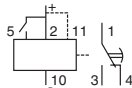

2-10 Supply  
(2-11) Bridge  
2-5 Control contact or reset  
1-3-4 Timed output contact

### Timer 814 - 11-pin

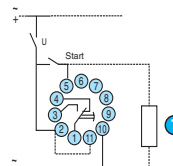

① Other loads may be connected in parallel

### Timer 814 - 8-pin

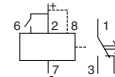

2-7 Supply  
(2-8) Bridge  
2-6 Control contact reset  
1-3-4 Timed output contact

### Timer 815 - 11-pin

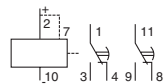

2-10 / 2-7 Supply  
(2-7) Bridge  
1-3-4 Timed output contact  
8-9-11 Timed or instantaneous output contact

3

# 816 digital timers

## → 816

### Relay output

- Multi-range
- Multi-voltage
- 1 relay output
- Access to programming locked
- Up or down timing mode
- Internal power supply by battery (10 years / 20°C)



### Specifications

Type	Functions	Connections	Relay outputs	Supply voltage	Nominal rating	Code
Timer 816	A, B, C, D, Di, H	8-pin plug-in	1 timed changeover	24 V AC DC/48 V AC DC	8 A	88 857 604
	A, B, C, D, Di, H	8-pin plug-in	1 timed changeover	24 V AC DC/110 V AC	8 A	88 857 607
	A, B, C, D, Di, H	8-pin plug-in	1 timed changeover	24 V AC DC/220.240 V AC	8 A	88 857 601
	A, B, C, D, Di, H	11-pin plug-in	1 timed changeover	24 V AC DC/48 V AC DC	8 A	88 857 704
	A, B, C, D, Di, H	11-pin plug-in	1 timed changeover	24 V AC DC/48 V AC DC	8 A	88 857 707
	A, B, C, D, Di, H	11-pin plug-in	1 timed changeover	24 V AC DC/220. 240 V AC	8 A	88 857 701

### Accessories

	Code
Asymmetrical adaptor A	79 694 005
8-pin solder-connected plug	25 622 301
11-pin solder-connected plug	25 622 076
8-pin solder-connected base	79 694 016
Spring clips	79 237 790
11-pin connector socket	25 622 077
8-pin connector socket	25 622 128
11-pin rear base	79 694 002

### Connections

#### Timer 816 - 11-pin

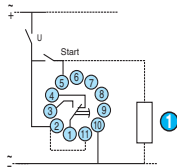

① Other loads may be connected in parallel

#### Timer 816 - 8-pin

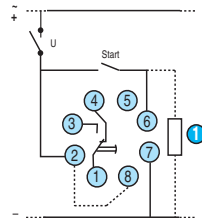

① Other loads may be connected in parallel

#### Timer 816 - 11-pin

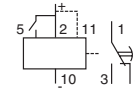

2-10 Supply  
(2-11) Bridge for 24 V supply  
2-5 Control contact reset  
1-3-4 Timed output contact

#### Timer 816 - 8-pin

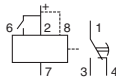

2-7 Supply  
(2-8) Bridge for 24 V supply  
2-6 Control contact reset  
1-3-4 Timed output contact

## General characteristics

### Display

Number of digits	4
Height of digits	7 mm

### Precision

Timing ranges	99 → 99 s 999 → 9 s 9999 s 99 mn 59 s 99 → 99 mn 999 → 9 mn 9999 mn 99 h 59 mn 99 → 99 h 999 → 9 h 9999 h
---------------	---

Repetition accuracy (with constant parameters)	± 0.03 % ± 20 ms
Display accuracy	± 0.03 % ± 20 ms
Min. control pulse	50 ms
Maximum reset time by de-energisation during timed delay	50 ms
Maximum reset time by de-energisation after timing	50 ms

### Output specification

Nominal rating	8 A AC 8 A DC
Max. breaking voltage	250 AC 30 V DC
Maximum power rating (resistive)	2000 VA - 190 W
Maximum admissible current	15 A < 0.01 s
Minimum current	100 mA
Electrical life at I max., 250 V AC resistive (cycles)	10 <sup>5</sup>
Max. permitted number of operations at 1 max 250 V AC resistive per hour	600
Mechanical life (operations)	5 x 10 <sup>6</sup>

### Function and use

Voltage variation	+ 10 % - 15 %
Immunity from micro power cuts	< 0.03 s
Maximum power consumption	0.5 W/24 V 1.5 W/48 V 1 VA/24 V 1, 5, VA/48 V 4 VA/110 V 12 VA/230 V
Temperatures limits use (°C)	-10 → +60
Temperature limits stored (°C)	-30 → +70
Degree of protection front face	IP65
Insulation according to standard VDE 0110-IEC 255 group C	•
Protection class according to UTE C 20010 - IEC 529 - DIN 40050	•
Conformity to standards ICE 255 - VDE 0435 - 2021	•
Mounting Front panel, by clip	•
Mounting base-mounted on socket	•
Material	Self-extinguishing UL 94 grade V0
Weight (g)	100

## Curves

### Function A

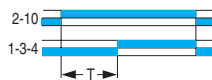

Delay on energisation 1 timed relay

### Function D

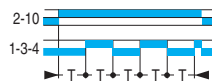

Flip-flop

### Function B

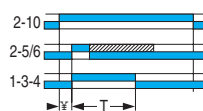

Timing on impulse (on shot)

### Function Di

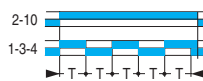

Flip-flop

### Function C

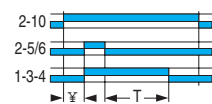

Timing after impulse (delay off)

### Function H



Timing or energisation

## Dimensions

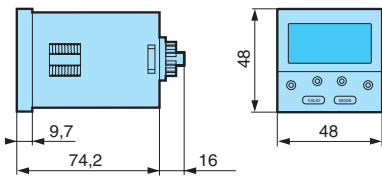

11-pole rear base 79 694 002 Panel-mounted

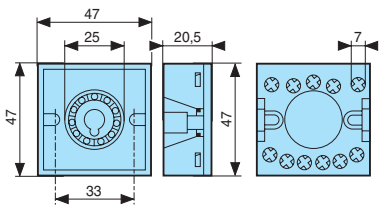

Connector socket 11-pin 25 622 077  
8-pin 25 622 128

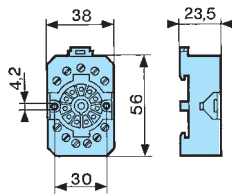

### Panel cut-out

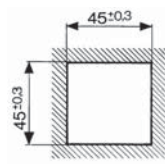

8-pin or 11-pin solder-connected plug  
25 622 076 - 25 622 301

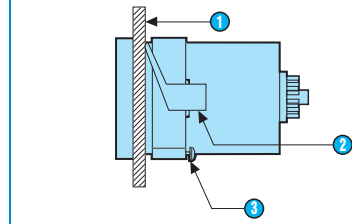
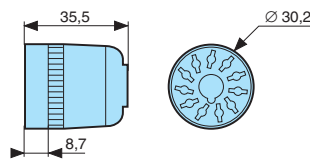

- 1 Panel thickness 1 to 3.5 mm
- 2 Clip for panel-mounting
- 3 Positioning screw

8-pin solder-connected base  
79 694 016

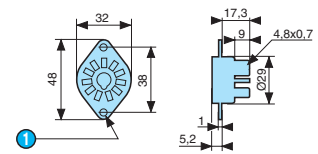

- 1 2 holes





# MBA Ø 22 panel-mounted timers

## → MBA

### Solid state output

- Panel-mounted pushbutton-type timer
- Function A delay on energisation
- 10 timing ranges : 0.05 s to 60 min
- Supply 24 V DC and 110 → 240 V DC AC 50 → 60 Hz
- Fast adjustment of timing period on PLCs (compatible with IEC1131)
- IP 65



### Specifications

Type	Functions	Time ranges	Output	Supply voltage	Nominal rating	Code
MBA2F	A	0.1 s → 1 s	State	100 → 240 V AC/DC	400 mA	88 901 308
	A	0.5 s → 10 s	State	100 → 240 V AC/DC	400 mA	88 901 328
	A	3 s → 60 s	State	100 → 240 V AC/DC	400 mA	88 901 348
	A	0.5 min → 10 min	State	100 → 240 V AC/DC	400 mA	88 901 378
	A	3 min → 60 min	State	100 → 240 V AC/DC	400 mA	88 901 398
MBA3F	A	0.1 s → 1 s	State	24 V DC	200 mA	88 901 302
	A	0.5 s → 10 s	State	24 V DC	200 mA	88 901 322
	A	3 s → 60 s	State	24 V DC	200 mA	88 901 342
	A	0.5 min → 10 min	State	24 V DC	200 mA	88 901 372
	A	3 min → 60 min	State	24 V DC	200 mA	88 901 392

### General characteristics

#### Precision

Repetition accuracy (with constant parameters)	+/-0.2 %
Display accuracy	± 5 %
Maximum reset time by de-energisation MBA3F during timed delay	7 ms
Maximum reset time by de-energisation MBA3F after timing	5 ms
Maximum reset time by de-energisation MBA2F after timing	60 ms
Maximum reset time by de-energisation MBA2F after timing	30 ms

#### Output specification

Solid state open collector PNP output	•
Voltage drop at terminals	MBA2F : ≤ 5 V AC MBA3F : ≤ 3 V DC
Nominal rating	MBA2F : 400 mA at 200C (derating 5 mA/°C) MBA3F : 200 mA at 20 °C (derating 1.5 mA/°C)
Leakage current	MBA2F : ≤ 5 mA AC MBA3F : ≤ 0.1 mA DC
Electrical life (number of operations)	> 10 <sup>8</sup>
Protection against polarity inversions	MBA3F
Protection against load short circuits	MBA3F
Immunity from micro power cuts	•

#### Function and use

Display of output state by LED : output in operation	•
Display of output state by LED : Power on	•
Dielectric strength	1500 V / 50 Hz / 1 min
Ripple	± 10 %
Consumption	•
Temperatures limits use (°C)	-20 → +60
Temperature limits stored (°C)	-20 → +80
Varistor protection against overvoltage	•
Drift Temperature	+/- 0.05 %/°C
Drift Voltage	+/- 0.2 %/V
Conformity to standards VDE 0435 / ICE 255 / ICE 1131 / ICE 801 4	•
Protection class according to NFC C 20010-IEC 529-DIN 40050 Panel-mounted	IP65
Protection class according to NFC C 20010 - IEC 529 - DIN 40050 Terminal	IP10
Material housing	•
Terminal capacity Single-wire	1 x 4 mm <sup>2</sup>
Terminal capacity Multi-wire with ferrule	1 x 2.5 mm <sup>2</sup>
Terminal screws	M3
Tightening torque (Nm)	0.5 Nm
Weight (g)	27

## Dimensions

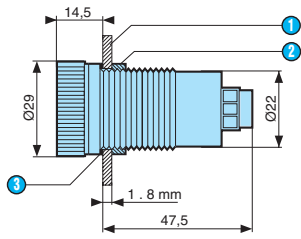

- 1 Panel
- 2 Nut
- 3 Sealing ring

## Panel cut-out

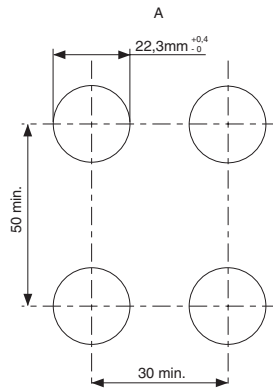

## Connections

### Version 110 - 240 V DC AC 50 - 60 Hz

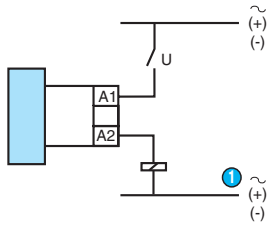

- 1 Load

### Version 24 V DC on relay

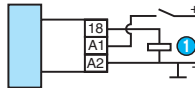

- 1 Load

### Version 24 V DC on PLC

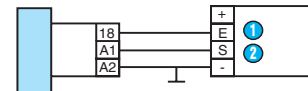

- 1 Input
- 2 Output

# Panel-mounted electromechanical timers

## → Top 2000

### Relay output

- Mono-voltage
- 1 timed changeover and 1 instantaneous contact
- Elapsed time can be saved mechanically in the event of a break in supply
- Progress of cycle displayed
- Housing 48 x 48 mm
- Connection by screw-terminal base or 8-pin base



### Specifications

Type	Relay outputs	Functions	Voltages	Code
6 s - 12 mm	1 time changeover 5 A 1 instantaneous	Multi-function 2 - 3 - 4	24 V AC	88 226 013
			42 → 48 V AC	88 226 019
			110 → 127 V AC	88 226 012
			220 → 240 V AC	88 226 011
			24 V AC	88 226 501
			42 → 48 V AC	88 226 502
			110 → 127 V AC	88 226 503
6 min - 12 h	1 timed changeover 5 A 1 instantaneous	Multi-function 2 - 3 - 4	220 → 240 V	88 226 504
			24 V AC - 50 Hz	88 226 016
			24 VAC 50 Hz	88 226 505
			42 → 48 V AC - 50 Hz	88 226 017
			42 → 48 VAC 50 Hz	88 226 506
			110 → 127 V AC - 50 Hz	88 226 015
			110 → 127 VAC 50 Hz	88 226 507
			220 → 240 V AC - 50 Hz	88 226 014
			220 → 240 VAC 50 Hz	88 226 508

### Accessories

	Code
Solder tag connector 8-pin	25 622 301
8-pin connector base	25 622 128
Invertor for DC supply CC24 148 V DC	84 861 501
Invertor for DC supply CC110 1127 V DC	84 861 503

### Curves

#### Function 2



#### Function 3

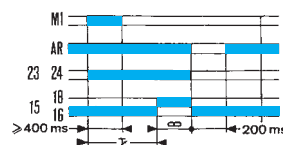

#### Function 4



On energisation, chance of contact bounce on instantaneous contact for 250 ms.

## General characteristics

### Precision

Precision limit error	± 2 % (± 5 %/6 s)
Repetition accuracy	± 1.5 % (± 4 %/6 s)
Selection precision	See "timing ranges" table for scale graduation
Reset time	0.20 s

### Output specification

Timed two-pole	1
Instantaneous single pole	1
Thermal rating	6.3 A
Rating (cos φ = 0.41) 10 <sup>4</sup> operations	5 A - 230 V

### Function and use

Absorbed power--motor	3 VA cos φ 0.8
Voltage variation at maximum temperature of 55 °C according to IEC 255 100	24 V +10 % - 42 V -15 % 48 V +10 % - 110 V -20 % 127 V 0 % - 220 V -20 % 240 V 0 %
Operator factor	100 %
Temperatures limits use (°C)	-10→ +55
Temperature limits stored (°C)	-20→ 70
Environmental protection Tropicalised to IEC 68-2-10	•
Vibration withstand on 3 axes (Veritas standard)	4 G - 55 Hz
Dielectric test voltage according to IEC 255 5 or VDE 0435	1000 V - Un ≤ 60 V 2000 V - Un > 60 V
Insulation according to standard VDE 0110 group C	380 V AC - 440 V DC
Protection Housing	IP 40
Protection Terminal	IP 10
Conformity to standards NFC 45250 - VDE 0110 - 0435 - 0660 or ICE 529	•
Connection : Screw/saddle	•
Terminal capacity Single-wire 1 or 2 leads Multi-wire	0.75 - 2.5 mm <sup>2</sup>
Terminal capacity Multi-wire 1 or 2 leads	0.5 - 1 mm <sup>2</sup>
Mounting : Base mounting on 8-pin socket	•
Weight (g)	185

## Dimensions

88 226 0

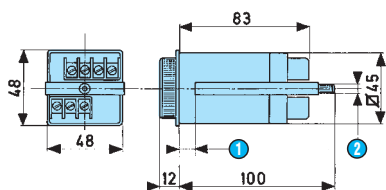

- ① Panel depth 10 mm max.
- ② M3 screw

**Solder tag connector**  
25 622 301 - 8-pin

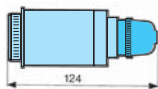

**Screw terminal or connector socket**  
26 622 128 - 8-pin

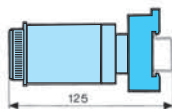

88 226 5

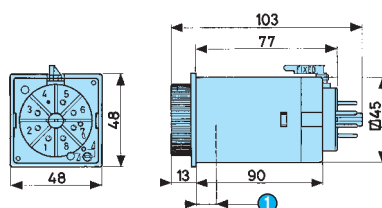

- ① Panel depth 10 mm max.

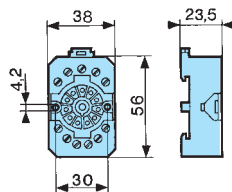
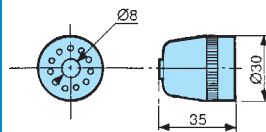

Panel cut-out

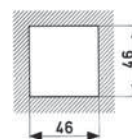

**Inverter for DC supply**  
84 861 501 : 24 - 48 V DC  
84 861 503 : 110 - 127 V DC  
Weight 150 g

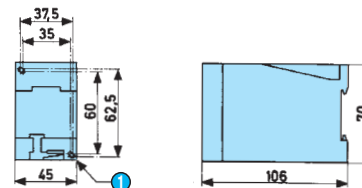

- ① Fixing holes ø 5

## Connections

### Function 2

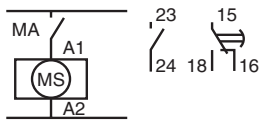

#### Internal layout 88 226 0

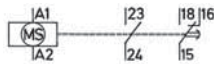

#### Terminal identification 88 226 5

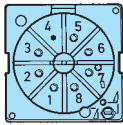

- 2-7 Supply
- 8-5-6 Timed contact
- 3-1 Instantaneous contact

### Function 3

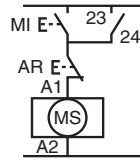

#### Terminal identification 88 226 0

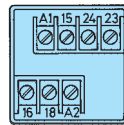

- A1-A2 Supply
- 15-16-18 Timed contact
- 23-24 Instantaneous contact

### Function 4

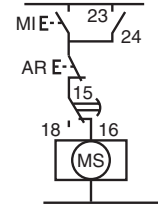

#### Internal layout 88 226 5

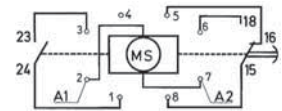



# Panel-mounted electromechanical timers

## → Manual reset

### Relay output

- Mono-function
- Mono-range
- Mono-voltage
- Manual reset
- Progress of cycle displayed
- Output : 1.2 or 3 changeover contacts (max of 16 A per contact)
- Mounting option



## Specifications

Type	Voltage	Relay outputs	Breaking capacity per contact	Version	Maximum available timing	Dial graduation	Code				
882564	127/230 V AC 50 Hz	1 timed	16 A	5 min	4 min 40 s	15 s	<b>88 256 401</b>				
				15 min	14 min	30 s	<b>88 256 402</b>				
				30 min	28 min	1 min	<b>88 256 403</b>				
				60 min	56 min	2 min 30 s	<b>88 256 404</b>				
				120 min	1 h 53 min	5 min	<b>88 256 405</b>				
				5 h	4 h 43 min	5 min	<b>88 256 406</b>				
				15 h	14 h 10 min	30 min	<b>88 256 407</b>				
				30 h	28 h 20 min	1 h	<b>88 256 408</b>				
				882565	127/230 V AC 50 Hz	2 timed	16 A	5 min	4 min 40 s	15 s	<b>88 256 506</b>
								15 min	14 min	30 s	<b>88 256 507</b>
30 min	28 min	1 min	<b>88 256 508</b>								
60 min	56 min	2 min 30 s	<b>88 256 509</b>								
120 min	1 h 53 min	5 min	<b>88 256 510</b>								
5 h	4 h 43 min	5 min	<b>88 256 511</b>								
15 h	14 h 10 min	30 min	<b>88 256 512</b>								
30 h	28 h 20 min	1 h	<b>88 256 513</b>								
882569	127/230 V AC 50 Hz	3 timed	16 A					5 min	4 min 40 s	15 s	<b>88 256 906</b>
								15 min	14 min	30 s	<b>88 256 907</b>
				30 min	28 min	1 min	<b>88 256 908</b>				
				60 min	56 min	2 min 30 s	<b>88 256 909</b>				
				120 min	1 h 53 min	5 min	<b>88 256 910</b>				
				5 h	4 h 43 min	5min	<b>88 256 911</b>				
				15 h	14 h 10 min	30 min	<b>88 256 912</b>				
				30 h	28 h 20 min	1 h	<b>88 256 913</b>				

## Accessories

	Code
Invertor for DC supply 24 . 48 V	<b>88 861 501</b>
Invertor for DC supply 110 . 127 V	<b>88 861 503</b>

## General characteristics

Precision	
Precision limit error	± 4 %
Output specification	
Timed two-pole	1 or 2 or 3
Thermal rating	20 A
Mechanical life (operations)	> 10 <sup>7</sup>
Rating (cos φ = 0.41) 10 <sup>4</sup> operations	16 A - 230 V
Function and use	
Voltage variation at maximum temperature of 55 °C according to IEC 255 100	+10 % -15 % Un
Absorbed power--motor	3.1 VA cos φ 0.8
Operator factor	100 %
Temperatures limits use (°C)	-5→+70
Temperature limits stored (°C)	-40→+80
Environmental protection Protected metal components - Insulated motor coil	•
Vibration withstand on 3 axes (Veritas standard)	4 G - 55 Hz
Dielectric test voltage according to IEC 255-5 or VDE 0435	1000 V - Un ≤ 60 V
Insulation according to standard VDE 0110 group C	380 V AC, 440 V DC
Protection : terminal	IP10
Operating position- any	•
Connection : Tags	6.35
Connection : Motor leads	250 mm
Mounting by screw	2 x M3 - 2 x M4
Weight (g)	225 / 245

To order, see page 6



## Dimensions

### Panel cut-out

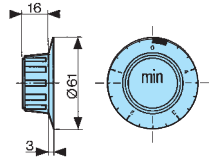
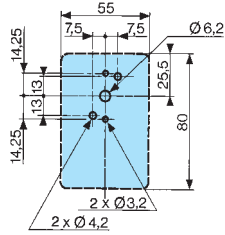

Inverter for DC supply  
 84 861 501 : 24 - 48 V DC  
 84 861 503 : 110 - 127 V DC  
 Weight 150 g

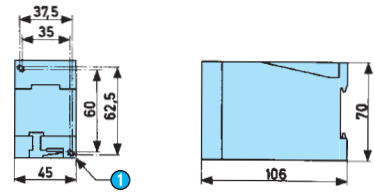

1 Fixing holes  $\varnothing 5$

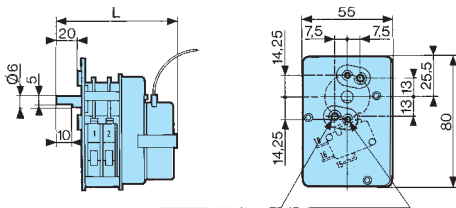

88 256 4 : L = 72 mm  
 88 256 5 : L = 83,5 mm  
 88 256 9 : L = 94 mm

## Connections

### 1 pole

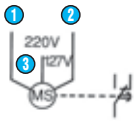

- 1 Red
- 2 Blue
- 3 White

### 2 poles

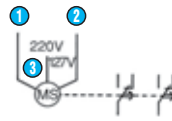

- 1 Red
- 2 Blue
- 3 White

### 3 poles

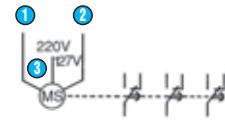

- 1 Red
- 2 Blue
- 3 White

### 1 pole

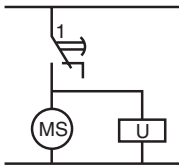

### 2 poles

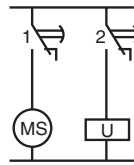

### 3 poles

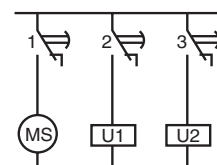

### 2 poles

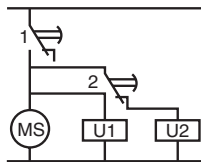

## Curves

### 1 pole

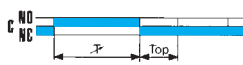

### 2 poles

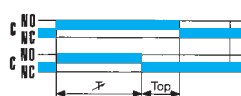

### 3 poles

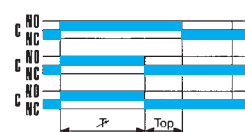



# Control relays



Control relays



4



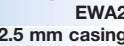

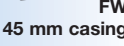



Control function	Output relay	Operating range	Designation	Power supply		
• Loss or inversion of one of the phases	1 changeover	3 x 230 to 440 V AC	EWS	3 x 200 to 500 V AC	Page 120	
	2 changeovers		EWS2			
• Total phase failure • Phase sequence • Voltage drop on one or more phases	2 changeovers	3 x 230 V AC	EW2	3 x 230 V AC	Page 122	
		3 x 400 V AC		3 x 400 V AC		
• Total phase failure • Phase sequence • Voltage drop on one or more phases • Asymmetry between phases of 5 to 15%	2 changeovers	3 x 230 V AC	EWA2	3 x 230 V AC	Page 122	
		3 x 400 V AC		3 x 400 V AC		
• Phase sequence • Loss of one or more phases • Undervoltage • Supply voltage setpoint adjustable by potentiometer	2 changeovers	180 to 260 V AC	FW	3 x 230 V AC	Page 124	
		310 to 440 V AC		3 x 380 V AC		
		320 to 460 V AC		3 x 400 V AC		
		330 to 480 V AC		3 x 415 V AC		
		350 to 510 V AC		3 x 440 V AC		
		380 to 550 V AC		3 x 480 V AC		
460 to 660 V AC	3 x 575 V AC					
• Asymmetry between phases of 5 to 20 % • Phase sequence • Loss of one or more phases with 95% regenerated supply voltage	1 changeover	0.8 to 1.2 x supply voltage	FWA	3 x 230 V AC	Page 126	
	2 changeovers			3 x 400 V AC		
			2 changeovers	FWA2		
	2 changeovers			FWA2		

EWA2  
22.5 mm casing

FW  
45 mm casing

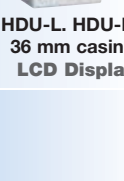



# VOLTAGE control relays

Supply configuration	Self-powered	Measurement range	Designation	Power supply			
Single-phase	No	0.2 to 60 V DC	EUL	24 V DC	Page 138		
		0.2 to 60 V AC/DC		24 V AC			
				120 V AC			
		230 V AC					
		15 to 600 V DC	EUH	24 V DC			
		15 to 600 V AC/DC		24 V AC			
				120 V AC			
		230 V AC					
	Yes	-	-	EUS	24 V DC	Page 140	
					24 V AC		
HDU-L LCD Display				120 V AC			
				230 V AC			
-	-	-	HDU-H LCD Display	24 V DC	Page 130		
				24 V AC			
			EUSF 2 thresholds (high/low)	120 V AC			
				230 V AC			
3-phase	Yes	-	F3US - Phase-to-phase control	12 V DC	Page 142		
				20 to 80 V AC/DC			
			F3USN - Control between phase and neutral	65 to 260 V AC/DC			
				20 to 80 V AC/DC			
65 to 260 V AC/DC							
65 to 260 V AC/DC							
3 x 230 V AC							
3 x 400 V AC							
3 x 230 V AC							
3 x 400 V AC							

EUL  
22.5 mm casing

HDU-L, HDU-H  
36 mm casing  
LCD Display

F3US  
45 mm casing

Control function	Measurement range	Designation	Power supply			
ALTERNATING current	1 to 20 A	MCI	24 V AC/DC - 110 to 240 V AC	Page 134	 MCI 17.5 mm casing	
	10 to 100 A With current transformer (optional)	EIT	24 V DC	Page 136		
			24 V AC			
			48 V AC			
			120 V AC			
230 V AC						
DIRECT current	2 to 500 mA	EIL	24 V DC	Page 136	 EIH 22.5 mm casing	
	0.1 to 10 A	HDI-L LCD Display	24 V DC	Page 130		
		EIH	24 V AC	Page 136		
		HDI-H LCD Display	24 V DC	Page 130		
		24 V AC	Page 136			
ALTERNATING and DIRECT current	2 to 500 mA	EIL	24 V AC	Page 136	 EIH 22.5 mm casing	
			48 V AC			
			120 V AC			
		230 V AC				
		HDI-L LCD Display	24 V AC			Page 130
			120 V AC			
	230 V AC					
	0.1 to 10 A	EIH	24 V AC	Page 136		 HDI-L, HDI-H 36 mm casing LCD Display
			48 V AC			
			120 V AC			
		230 V AC				
		HDI-H LCD Display	24 V AC			
120 V AC						
230 V AC						

→ Motor LOAD control relay (Cos. φ)

Control function	Output relay	Designation	Power supply		
Controlling motor under/overload by measuring the phase shift between the voltage and the current (φ)	2 changeovers (1 per threshold)	FFP Independent adjustment of min. and max. thresholds	3 x 230 V AC	Page 144	 FFP 45 mm casing
			3 x 400 V AC		
			3 x 440 V AC		
			3 x 480 V AC		
			3 x 575 V AC		

→ Motor UNDERSPEED control relay

Control function	Output relay	Designation	Power supply		
Control of motor underspeed, stopping, running speed or jamming.	1 changeover	FRL	24 V DC	Page 146	 FRL 45 mm casing
			24 V AC		
			110 V AC		
			230 V AC		

→ Motor THERMAL PROTECTION relay

Control function	Output relay	Designation	Power supply		
Control of machine temperatures by integrated PTC probes with line break or probe short-circuit detection.	1 NO contact	ETM	24 V AC/DC	Page 148	 ETM 22.5 mm casing
			120 V AC		
			230 V AC		
	1 changeover	ETM2	24 V AC/DC		
			120 V AC		
			230 V AC		
	2 changeovers	ETM22	24 V AC/DC		
			120 V AC		
			230 V AC		

## Relays for controlling LEVELS of conductive liquids

Control function	Sensitivity	Designation	Power supply		
Filling OR emptying with timing (1 or 2 levels: high/low)	LOW sensitivity 250 Ω - 5 kΩ NORMAL sensitivity 5 kΩ - 100 kΩ HIGH sensitivity 50 kΩ - 1 MΩ	ENRM	24 V AC	Page 106	
			120 V AC		
			230 V AC		
Filling OR emptying (2 levels: high/low)	Without alarm Sensitivity 5 kΩ - 100 kΩ	ENR	24 V AC	Page 104	
			120 V AC		
			230 V AC		
	With alarm (Overflow or running dry) Sensitivity 5 kΩ - 100 kΩ	FN	24 V AC	Page 116	
			48 V AC		
			120 V AC		
Emptying (1 or 2 levels: high/low)	Sensitivity 5 kΩ - 100 kΩ	LN	24 V AC	Page 110	
			120 V AC		
			230 V AC		
Combined filling AND emptying (2 levels: high/low)	Sensitivity 5 kΩ - 100 kΩ	F2N	24 V AC	Page 114	
			48 V AC		
			120 V AC		
		L2N	24 V AC	Page 112	
			120 V AC		
			230 V AC		

ENRM  
22.5 mm casing

FN  
45 mm casing

LN  
45 mm casing

4

## Single-phase 300 W variable speed controller

Function	Control voltage	Power supply	Output	Current	
<ul style="list-style-type: none"> <li>Control fan speeds in air-conditioning applications</li> <li>For 150 to 300 W asynchronous motor with permanent dephasing via capacitor</li> </ul>	0 / 10 V	230 VAC	1 relay	8 A	Page 152



VRT 300

# Level control

## → ENR filling or emptying function

- Regulation of two levels (min./max.)
- Monitoring filling (UP) or emptying (DOWN) , selected by a switch on the front panel.
- Probes supplied with AC current.
- Sensitivity adjustable on front panel from 5 kΩ to 100 kΩ.



### Specifications

Type	Characteristics	Voltages	Code
ENR	Monitoring filling (UP) Monitoring emptying (DOWN)	24 V AC	84 870 201
		48 V AC	84 870 202
		120 V AC	84 870 203
		230 V AC	84 870 204

### General characteristics

Operating range	0.85 → 1.10 x Un
Maximum power consumption	3 VA
Adjustable sensitivity	5 kΩ → 100 kΩ
Measurement accuracy (at maximum sensitivity)	± 30 %
Electrode voltage (max)	24 V AC (50/60 Hz)
Electrode current (maximum)	1 mA (50/60 Hz)
Maximum cable capacity	10 nF
Response time high level	300 ms
Response time low level	500 ms
Output relay (according to AC1 resistive load)	1 AgNi changeover relay 8 A AC max.
Galvanic isolation via transformer (4 kV, 8 mm creepage distance)	Class II VDE 0551
Isolation of contacts and electrodes from power supply	2.5 kV AC
Operating temperature range (°C)	-20 → +50°C
Storage temperature range (°C)	-40 → +70°C
Weight (g)	150

### Dimensions

ENR

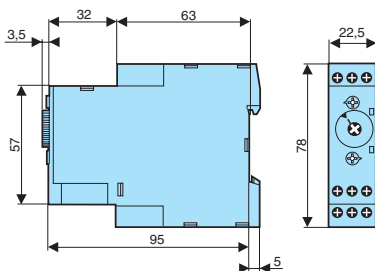

### Connections

ENR

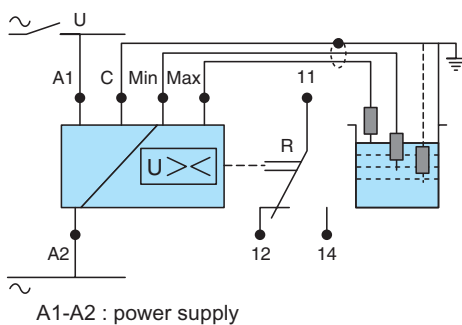

To order, see page 6



## Principles

### Monitoring filling or emptying ENR

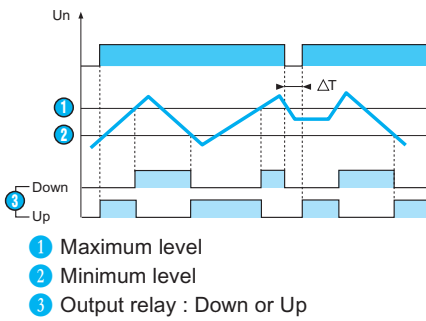

#### Operating principle

Monitoring maximum and/or minimum levels of conductive liquids (tap water, sea water, waste water, chemical solutions, coffee, etc).

The principle is based on measuring the apparent resistance of the liquid between two submerged probes. When this value is lower than the preset threshold displayed on the unit's front panel, the output relay changes state. To prevent any occurrences of electrolysis, an AC current is passed through the probes. Areas of application include the agri-food, chemical and other industries.

#### Adjusting two levels : Minimum/Maximum

The output relay changes state when the level of liquid reaches the maximum electrode, with the minimum electrode submerged. It returns to its initial state when the minimum probe is no longer in contact with the liquid.

#### Note

If the power break T lasts for 1 second or more, the relay reenergises instantly when in "UP" mode and is de-energised when in "DOWN" mode.

## Other information

The probe cable (maximum length 100 metres) does not have to be screened, but avoid mounting it in parallel with the power supply cables. A screened cable can be used with the screening connected to the common terminal.

# Level control

## → ENRM filling or emptying with adjustable time delay

- Regulation of one or two levels (min./max.)
- Monitoring filling (UP) or emptying (DOWN) selected by a switch on the front panel.
- Probes supplied with AC current.
- Sensitivity adjustable on front panel from 250 Ω to 1 MΩ.
- Time delay preventing wave effect adjustable from 0.1 to 5s.



### Specifications

Type	Characteristics	Voltages	Code
ENRM	Monitoring filling (UP) Monitoring emptying (DOWN)	24 V AC	84 870 211
		48 V AC	84 870 212
		120 V AC	84 870 213
		230 V AC	84 870 214

### General characteristics

Operating range	0.85 → 1.10 x Un
Maximum power consumption	3 VA
Adjustable sensitivity	250 Ω → 1 MΩ
Measurement accuracy (at maximum sensitivity)	± 30 %
Electrode voltage (max)	24 V AC (50/60 Hz)
Electrode current (maximum)	1 mA (50/60 Hz)
Maximum cable capacity	10 nF
Response time high level	300 ms
Response time low level	500 ms
Output relay (according to AC1 resistive load)	1 AgNi changeover relay 8 A AC max.
Galvanic isolation via transformer (4 kV, 8 mm creepage distance)	Class II VDE 0551
Isolation of contacts and electrodes from power supply	2.5 kV AC
Operating temperature range (°C)	-20 → +50°C
Storage temperature range (°C)	-40 → +70°C
Weight (g)	150

### Dimensions

#### ENRM

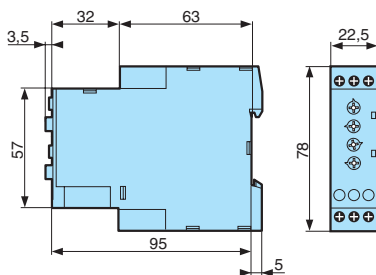

## Connections

### Adjusting two levels Monitoring filling "Up"

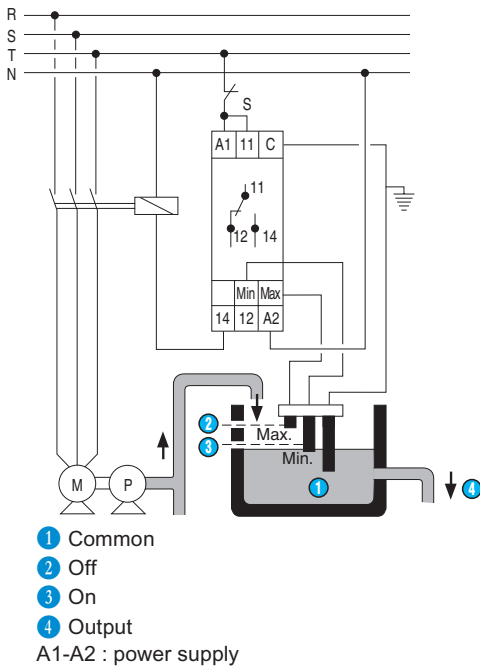

### Monitoring emptying "Down"

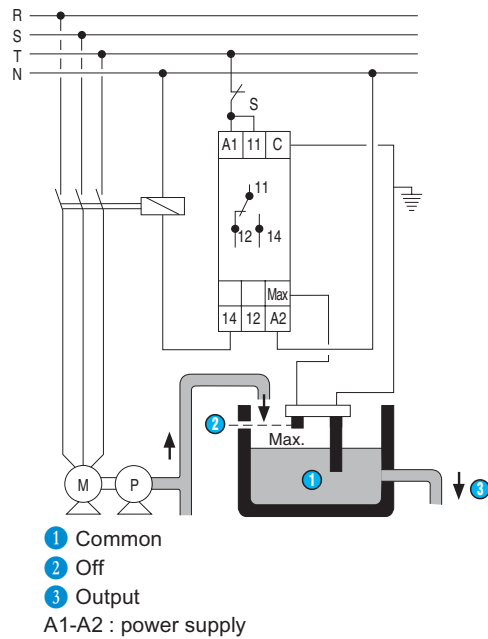

## Principles

### Operating principle

#### General principle :

The ENRM monitors the levels of conductive liquids. The principle is based on measuring the apparent resistance of the liquid between two submerged probes. When this value is lower than the preset threshold displayed on the unit's front panel, the relay changes state. To prevent any occurrences of electrolysis, an AC current is passed through the probes. A rotary switch on the front panel can be used to select the desired function and sensitivity range. A level can be monitored using the 2<sup>nd</sup> rotary switch. In this instance, the max. probe remains above the liquid and an adjustable time delay prevents the wave effect.

A green LED indicates that the supply voltage is present.

A yellow LED indicates the output relay's state.

When the green and yellow LEDs are flashing, this indicates an incompatible adjustment position.

### Rotary switch in mode 2 - Activation time - Filling function

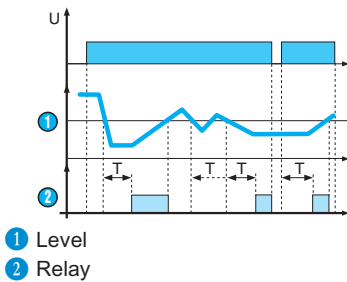

#### Monitoring a level, filling function, activation time

(level : 1 - on delay, function Up LS (Low Sensitivity : 250 W to 5 kW) , Up St (Standard Sensitivity : 5 kW to 100 kW) , Up HS (High Sensitivity : 50 kW to 1 MW).

When the level of liquid drops below the probe for a period exceeding the value of time delay T set on the front panel, the relay energises and remains on until the level of liquid reaches the probe again.

If the level of liquid returns above the level set before the time delay elapses, the relay does not come on.

#### Note

When the power returns after a power break, the output relay only energises after time delay T if the level of liquid is below the threshold.

### Rotary switch in mode 2 - Activation time - Emptying function

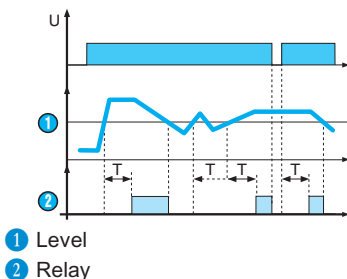

#### Monitoring a level, emptying function, activation time

(level : 1 - on delay, function Dwn LS (Low Sensitivity : 250 W to 5 kW) , Dwn St (Standard Sensitivity : 5 kW to 100 kW) , Dwn HS (High Sensitivity : 50 kW to 1 MW).

When the level of liquid rises above the probe for a period exceeding the value of time delay T set on the front panel, the relay energises and remains on until the level of liquid drops back below the probe.

If the level of liquid drops back below the level set before the time delay elapses the relay does not come on.

#### Note

When the power returns after a power break, the output relay only energises after delay time T if the level of liquid is above the threshold.

### Rotary switch in mode 3 - Deactivation time - Filling function

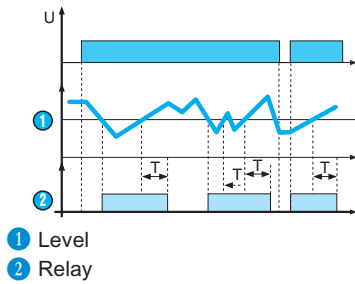

#### Monitoring a level, filling function, deactivation time

(level : 1 - off delay, function Up LS (Low Sensitivity : 250 W to 5 kW) or Up St (Standard Sensitivity : 5 kW to 100 kW) or Up HS (High Sensitivity : 50 kW to 1 MW).

When the liquid level drops below the probe the relay energises immediately and remains on until the level of liquid reaches the probe again and remains above it for a period exceeding time delay T set on the front panel.

If the level of liquid drops back below the level set before the time delay elapses, the relay remains on.

#### Note

When the power returns after a power break, the output relay energises immediately if the liquid level is below the threshold.

### Rotary switch in mode 3 - Deactivation time - Emptying function

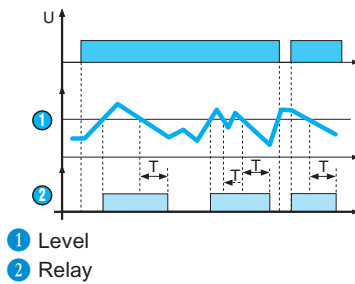

#### Monitoring a level, emptying function, deactivation time

(level : 1 - off delay, function Dwn LS (Low Sensitivity : 250 W to 5 kW) or Dwn St (Standard Sensitivity : 5 kW to 100 kW) or Dwn HS (High Sensitivity : 50 kW to 1 MW).

When the level of liquid rises above the probe the relay energises immediately and remains on until the level of liquid drops back below the probe for a period exceeding the value of time delay T set on the front panel.

If the level of liquid returns above the level set before the time delay elapses the relay remains on.

#### Note

When the power returns after a power break, the output relay energises immediately if the level of liquid is above the threshold.

### Monitoring two levels, emptying function

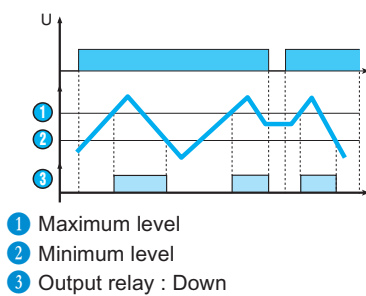

#### Monitoring two levels, emptying function

(level : 2, function Dwn LS (Low Sensitivity : 250 W to 5 kW) , Dwn St (Standard Sensitivity : 5 kW to 100 kW) , Dwn HS (High Sensitivity : 50 kW to 1 MW).

The output relay remains open as long as the level of liquid has not reached the maximum probe. Once the maximum level is reached the contact closes and the tank can then be emptied (valve opened, pump started, etc). When the level drops below the minimum level the contact opens and interrupts the emptying process.

Note : when monitoring two levels the time delay preventing the wave effect is not in operation.

#### Note

When the power returns after a power break, the output relay energises immediately if the level of liquid is above the threshold.

### Monitoring two levels, filling function

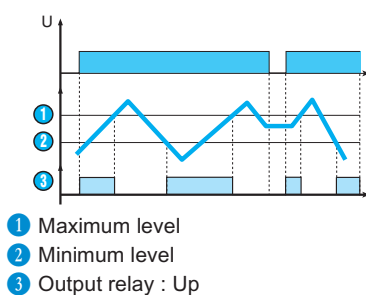

#### Monitoring two levels, filling function

(level : 2, function Up LS (Low Sensitivity : 250 W to 5 kW) or Up St (Standard Sensitivity : 5 kW to 100 kW) or Up HS (High Sensitivity : 50 kW to 1 MW).

The output relay remains on as long as the level of liquid has not reached the maximum probe. As soon as the maximum level is reached the contact opens and pumping stops. When the level drops below the minimum level the contact closes again and pumping restarts to bring the level of liquid back up.

Note : When monitoring the two levels the time delay preventing the wave effect is not in operation.

#### Note

When the power returns after a power break, the output relay energises immediately if the level of liquid is below the threshold.

## Other information

The probe cable (maximum length 100 metres) does not have to be screened, but avoid mounting it in parallel with the power supply cables. A screened cable can be used with the screening connected to the common terminal.



# Level control

## → LN plug-in emptying function

- Relay for controlling level of conductive liquids
- Regulation of two levels :
  - minimum
  - maximum
- Empty function
- Plug in (8 or 11 pins)
- Sensitivity adjustable from 5 kΩ to 100 kΩ



### Specifications

Type	Supply voltage	Base	Code
LN	24 V AC	8-pin	84 870 301
	120 V AC	8-pin	84 870 303
	230 V AC	8-pin	84 870 304
	24 V AC	11-pin	84 870 306
	120 V AC	11-pin	84 870 308
	230 V AC	11-pin	84 870 309
	230 V AC	11-pin (special base)	84 870 807

### General characteristics

Supply voltage $U_n$	230 V, 110 V, 48 V, 24 V AC, 50/60 Hz
Operating range	0.85 → 1.15 x $U_n$
Max. absorbed power	3 VA
Adjustable sensitivity	5 kΩ → 100 kΩ
Measurement accuracy (at maximum sensitivity)	0 → +30 %
Electrode voltage (max)	24 V AC (50/60 Hz)
Electrode current (maximum)	1 mA (50/60 Hz)
Maximum cable capacity	10 nF
Response time high level	300 ms
Response time low level	500 ms
Output relay (according to AC1 resistive load)	1 AgCdO switch 8 A AC max.
Galvanic isolation via transformer (4 kV, 8 mm creepage distance)	Class II VDE 0551
Isolation of contacts and electrodes from power supply	2.5 kV AC
Temperature limit operation (°C)	-20 → +60
Temperature limits stored (°C)	-30 → +70
Weight (g)	140

### Dimensions

LN

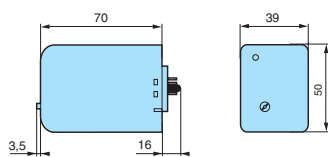

LN

Connector sockets  
11-pin: 25 622 078  
8-pin : 25 622 129

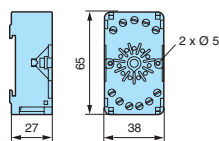

## Connections

LN

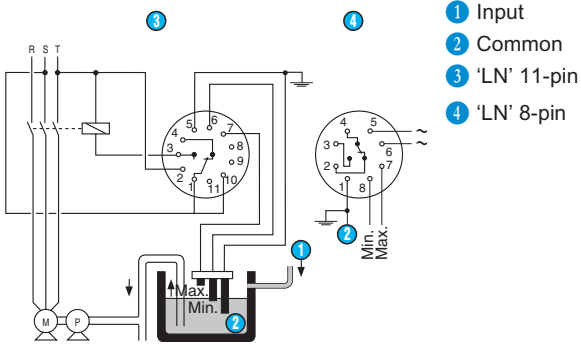

## Principles

### Emptying control

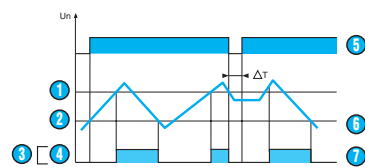

- 1 Max. level
- 2 Min. level
- 3 Output relay
- 4 Down
- 5 Unit power-up
- 6 Controlled level
- 7 Empty function

### Operating principle

Control of maximum and/or minimum levels of conductive liquids (tap water, sea water, waste water, chemical solutions, coffee etc).

The principle is based on measurement of the apparent resistance of the liquid between two submerged probes. When this value is lower than the preset threshold on the unit front face, the output relay changes state. To avoid electrolytic phenomena, an AC current flows across the probes. Applications found in environmental, chemical industries and food technology etc.

### Regulation of two levels : Minimum / Maximum

The output relay changes state when the level of liquid reaches the maximum electrode, with the minimum electrode submerged. It returns to its initial state when the minimum probe is no longer in contact with the liquid.

### Note

The probe wire (maximum 100 metres) does not have to be screened, but avoid mounting it in parallel with the power supply wires. A screened wire can be used, with the screening connected to the common.

# Level control

## → L2N plug-in filling/emptying function

- Relay for controlling level of conductive liquids
- Combined fill and empty functions
- Combined regulation of pumping out a well and filling a tank
- Plug in (11 pins)
- Output relay status display LED
- Sensitivity adjustable from 5 kΩ to 100 kΩ



### Specifications

Type	Supply voltage	Base	Code
L2N	24 V AC	11-pin	84 870 401
	120 V AC	11-pin	84 870 403
	230 V AC	11-pin	84 870 404
	230 V AC	11-pin (special base)	84 870 808

### General characteristics

Supply voltage $U_n$	230 V, 110 V, 48 V, 24 V AC, 50/60 Hz
Operating range	0.85 → 1.15 x $U_n$
Max. absorbed power	3 VA
Adjustable sensitivity	5 kΩ → 100 kΩ
Measurement accuracy (at maximum sensitivity)	0 → +30 %
Electrode voltage (max)	24 V AC (50/60 Hz)
Electrode current (maximum)	1 mA (50/60 Hz)
Maximum cable capacity	10 nF
Response time high level	300 ms
Response time low level	500 ms
Output relay (according to AC1 resistive load)	1 AgCdO switch 8 A AC max.
Galvanic isolation via transformer (4 kV, 8 mm creepage distance)	Class II VDE 0551
Isolation of contacts and electrodes from power supply	2.5 kV AC
Temperatures limits use (°C)	-20 → +60
Temperature limits stored (°C)	-30 → +70
Weight (g)	140

### Dimensions

L2N

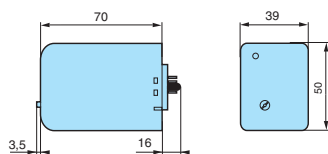

L2N

Connector sockets  
11-pin: 25 622 078  
8-pin : 25 622 129

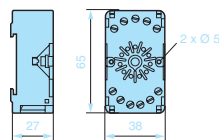

### Connections

L2N

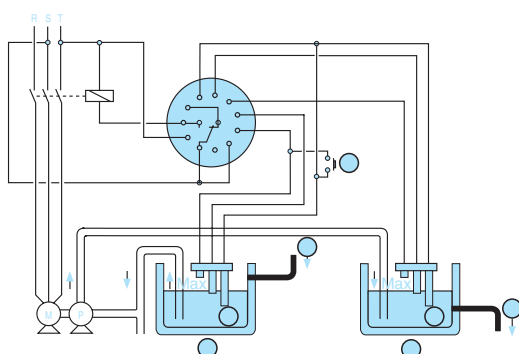

- ① Push button
- ② Output
- ③ Tank
- ④ Input
- ⑤ Common
- ⑥ Wells

To order, see page 6



## Principles

### Emptying control

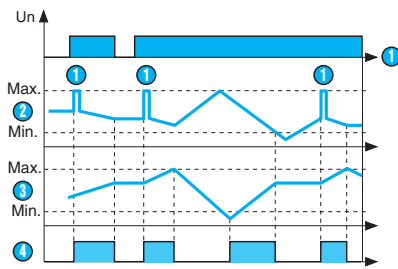

- ① Push button
- ② Well
- ③ Tank
- ④ Output relay

#### Operating principle

Control of maximum and/or minimum levels of conductive liquids (tap water, sea water, waste water, chemical solutions, coffee etc).

The principle is based on measurement of the apparent resistance of the liquid between two submerged probes. When this value is lower than the preset threshold on the unit front face, the output relay changes state. To avoid electrolytic phenomena, an AC current flows across the probes. Applications found in environmental, chemical industries and food technology etc.

#### Combined Fill / Empty function

The output relay changes state when the level of liquid in the tank reaches the "max" electrode, with the "min" electrode submerged. It returns to its initial state when the "min" sensor is no longer in contact with the liquid.

When the level of liquid in the well reaches the "min" electrode, the pump stops.

If, on power-up or after a power break, the "max" electrode in the tank is above the surface, reset the device by pressing the PB pushbutton.

#### Note

The probe wire (maximum 100 metres) does not have to be screened, but avoid mounting it in parallel with the power supply wires. A screened wire can be used, with the screening connected to the common.

# Level control

## → F2N filling/emptying function

- Control and automatic regulation of liquid levels.
- Sensitivity adjustment from 5 to 100 k $\Omega$ .
- Combined regulation : emptying a well and filling a tank
- LEDs indicate power supply and state of the output relay.



### Specifications

Type	Voltages	Code
F2N	24 VAC	84 870 601
	48 VAC	84 870 602
	120 VAC	84 870 603
	230 VAC	84 870 604

### General characteristics

#### Power supply characteristics

Operating range	0.85 to 1.15 Un except 120 V AC : 0.85 to 1.1 Un
Nominal power	3 VA max. to Un + 15 %
Maximal power	4 VA to Un ; 15 %
Immunity from micro power cuts	10 ms
Delay on pick-up	T1 = 400 ms
Response time on power-down	T4 = 500 ms
Insulation coordination	Category III, degree of pollution conforming to IEC 664.1 / VDE 0110 : 4 KV/2

#### Control technical characteristics

Sensitivity range	5 k to 100 k $\Omega$
Display accuracy	$\pm 30$ % with maximum sensitivity
Electrode voltage	15 V AC (50 .. 60 Hz)
Electrode current	1 mA
Accuracy	$\pm 30$ % with maximum sensitivity
Response time on immersion	T2 = 400 ms
Response time on emersion	T3 = 700 ms

#### Output characteristics

Output	1 AgCdO changeover
Breaking capacity	2000 VA - 80 W
Maximum breaking current	8 A AC DC
Minimum breaking current	100 mA AC DC
Max. breaking voltage	250 V AC DC
Mechanical life (operations)	$5 \times 10^6$
Electrical life AC 12	2000 VA - $10^3$ operations
Electrical life AC 15	Cos $\varphi$ = 0.3 - 6000 operations
Electrical life AC 13	L/R = 300 ms - 6000 operations

#### General characteristics

Material housing	Self-extinguishing
Terminal capacity	2 x 1.5 mm <sup>2</sup> with ferrule 2 x 2.5 mm <sup>2</sup> without ferrule
Temperature limit operation (IEC 68.1.14) (°C)	-20 → +60
Temperature limits stored (IEC 68.1.1/2) (°C)	-30 → +70
Relative humidity (no condensation)	93 % (+2 % ; -3 %)
Weight (g)	250

## Dimensions

F2N

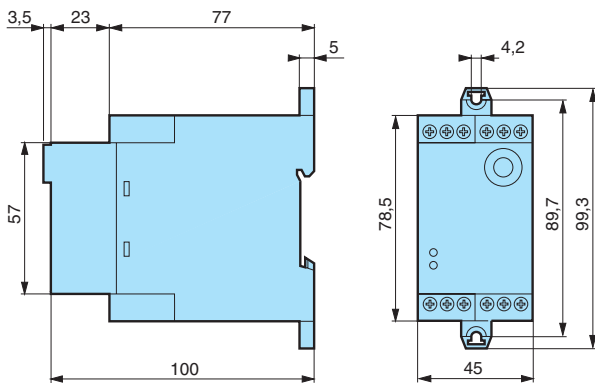

## Connections

F2N

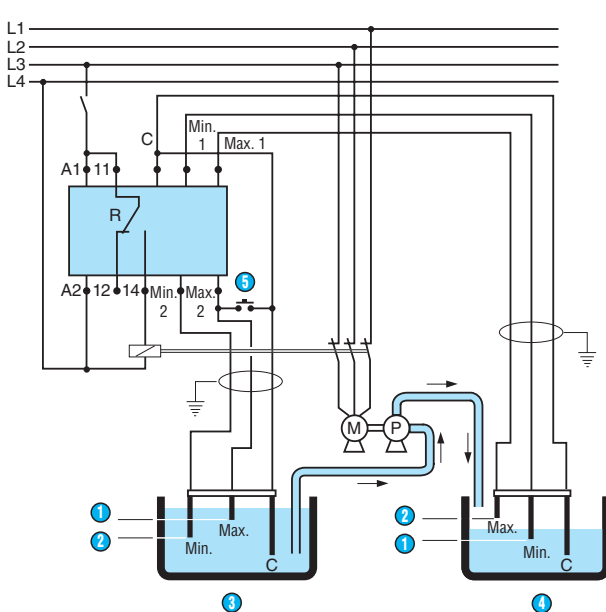

- 1 Start
- 2 Stop
- 3 Well or feeder tank
- 4 Tank
- 5 P.B.

A1 - A2 : Supply voltage  
11 - 12 - 14 : Output relay (R)

C - Min1 - Max1 : Tank probe inputs

C - Min2 - Max2 : Well or feeder tank probe inputs

## Principles

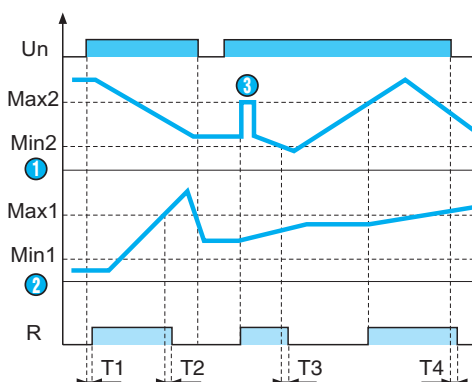

- 1 Min 2 Well
- 2 Min 1 Tank
- 3 P.B.

T1 : Delay on pick-up  
T2 : Response time on emersion  
T3 : Response time on immersion  
T4 : Response time on power-down

### Operating principle

Control of filling a tank at 2 levels (Min1, Max1) with simultaneous emptying control of the well or supply tank at 2 levels (Min2, Max2) in order to protect the pump from draining.

The principle is based on measurement of the apparent resistance of the liquid between the submerged probes. To avoid electrolytic phenomena, an AC current runs across the probes. In certain applications, a slight adjustment of the sensitivity enables the detection of undesirable elements such as the presence of foam or surface bubbles or the appearance of leakage impedance between probes (extended line capacity, humidity, etc).

### Filling / Emptying combined function

The output relay changes state (de-energises) when the level of liquid in the tank reaches the Max1 probe, with the Min1 probe submerged. It returns to its initial state (reattaches) when the Min1 probe is no longer in contact with the liquid.

When the level of liquid in the well reaches the Min2 probe, the pump stops (relay unstuck. Protection : prevents the pump from running when empty).

If the well Max2 probe is not submerged on power-up or after a power cut, the device must be reactivated by pressing the pushbutton (P.B.).

# Level control

## → FN filling/emptying function with alarm

- Automatic control and regulation of liquid levels.
- 2 sensitivity ranges.
- Filling or emptying function selected via dip switch.
- High or low alarm selected via dip switch.
- Memory can be selected.
- LEDs indicate state of power supply, output relay and alarm relay.



### Specifications

Type	Voltages	Code
FN LS	230 VAC	84 870 803
FN	24 VAC	84 870 501
	48 VAC	84 870 502
	120 VAC	84 870 503
	230 VAC	84 870 504

### General characteristics

Power supply characteristics	
Supply voltage Un	230, 120, 48 and 24 V AC 50/60 Hz galvanic isolation via transformer
Operating range	0.85 to 1.15 Un except 120 V AC : 0.85 to 1.1 Un
Nominal power	3 VA at Un
Maximal power	4 VA at Un + 15 %
Immunity from micro power cuts	10 ms
Delay on pick-up	T1 = approx. 2 s
Response time on power up	T4 = 500 ms
Insulation coordination	Category III, degree of pollution 2 conforming to IEC 664.1 / VDE0110 : 4 kV/2
Control technical characteristics	
Sensitivity range FN	5 kΩ → 100 kΩ
Sensitivity range FHLS	250 Ω → 5 kΩ
Display accuracy	± 30 % whith at maximum sensitivity
Electrode voltage	15 V AC (50/60 Hz)
Electrode current	1 mA
Response time on immersion	T2 = 400 ms
Response time on emersion	T3 = 700 ms
Output characteristics	
Output	2 AgCdO changeover
Breaking capacity	FN LS : 2000 VA FN : 80 W
Maximum breaking current	FN LS : 8 A AC FN : 8 A DC
Minimum breaking current	FN LS : 100 mA AC FN : 100 mA DC
Max. breaking voltage	FN LS : 250 V AC FN : 250 V DC
Mechanical life (operations)	2 x 10 <sup>6</sup>
Electrical life AC 12	2000 VA - 10 <sup>5</sup> operations
Electrical life AC 15	Cos φ = 0.3 - 6000 operations
Electrical life AC 13	L/R = 300 ms - 6000 operations
General characteristics	
Material housing	Self-extinguishing
Terminal capacity	2 x 1.5 mm <sup>2</sup> with ferrule 2 x 2.5 mm <sup>2</sup> without ferrule
Temperature limit operation (IEC 68.1.14) (°C)	-20 → +60
Temperature limits stored (IEC 68.1.1/2) (°C)	-30 → +70
Relative humidity (no condensation)	93 % (+2 % ; -3 %)
Weight (g)	280

## Dimensions

FN / FN LS

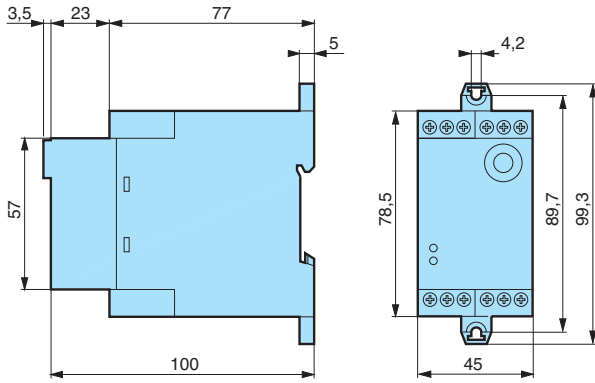

## Connections

Regulating with "up" filling control

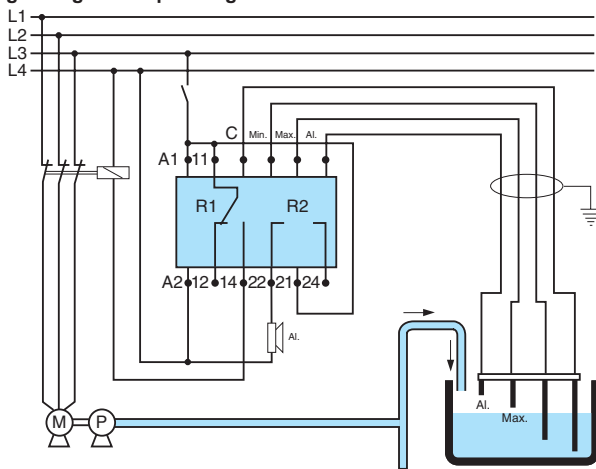

A1 - A2 : Supply voltage  
 11 - 12 - 14 : Output relay (R1)  
 21 - 22 - 24 : Alarm output relay (R2)  
 C - Min - Max - Al. : Probe inputs

## Principles

Filling control with low alarm

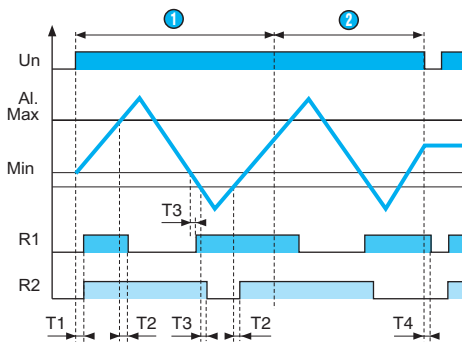

On power-up, probe Al. is submerged, relays R1 and R2 are energised and the pump is ON : filling starts, the LED for relay R1 is lit. When the level reaches the Max probe, relay R1 de-energises and the pump is OFF : filling stops, the LED for relay R1 goes off. Relay R1 re-energises when the Min probe emerges. In the event of a fault (level continues to fall) probe Al. emerges, relay R2 de-energises and the alarm is triggered : the LED for relay R2 is lit. This fault can be stored

- 1 Memory OFF
- 2 Memory ON

T1 : Delay on pick-up  
 T2 : Response time on immersion  
 T3 : Response time on emersion  
 T4 : Response time on power-down

Filling control with high alarm

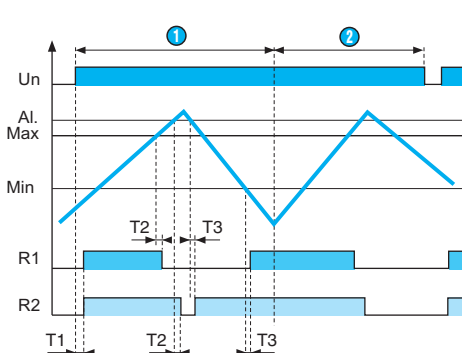

On power-up, the level in the tank is low, relays R1 and R2 are energised and the pump is ON : filling starts, the LED for relay R1 is lit. When the level reaches the Max probe, relay R1 de-energises and the pump is OFF : filling stops, the relay LED goes off. If, in the event of a fault, the level continues to rise and reaches probe Al., relay R2 de-energises and the alarm is triggered : the LED for relay R2 is lit.

- 1 Memory OFF
- 2 Memory ON

T1 : Delay on pick-up  
 T2 : Response time on immersion  
 T3 : Response time on emersion  
 This fault can be stored.

### Emptying control with low alarm

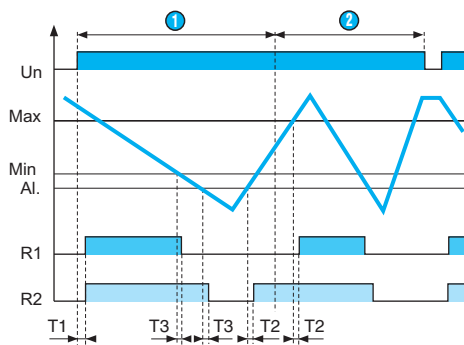

On power-up, probes Min, Max and Al. are submerged, relays R1 and R2 are energised and the pump is ON : emptying starts, the LED for relay R1 is lit. When the Min probe emerges, relay R1 goes off. If, in the event of a fault, the level continues to fall and probe Al. emerges, relay R2 de-energises and the alarm is triggered : the LED relay R2 is lit. This fault can be stored.

- ① Memory OFF
- ② Memory ON

T1 : Delay on pick-up  
 T2 : Response time on immersion  
 T3 : Response time on emersion

### Emptying control with high alarm

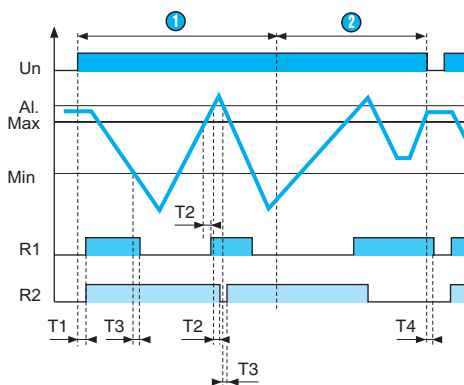

On power-up, probes Min, Max are submerged and probe Al. is above the level of the liquid. Relays R1 and R2 are energised and the pump is ON : emptying starts, the LED for relay R1 is lit. When the Min probe emerges, relay R1 de-energises and the pump is OFF : emptying stops, the LED for relay R1 goes off. If, in the event of a fault, the level continues to rise and reaches probe Al., relay R2 de-energises and the alarm is triggered : the LED for relay R2 is lit. This fault can be stored.

- ① Memory OFF
- ② Memory ON

T1 : Delay on pick-up  
 T2 : Response time on immersion  
 T3 : Response time on emersion  
 T4 : Response time on power-down

### Programming

	1	0
①	OFF	ON
②	③	④
③	⑤	⑥

- ① Memory
- ② Alarm
- ③ Function
- ④ Low
- ⑤ Emptying
- ⑥ High
- ⑦ Filling

### Operating principle

Control of the level of a conductive liquid at specific points (high and low levels) with an alarm for a level which is abnormally high or low.

The principle is based on measurement of the apparent resistance of the liquid between submerged probes. When this value is lower than the present threshold on the unit front face, the output relay R1 and/or the alarm relay R2 change state.

To avoid electrolytic phenomena, an AC current runs across the probes.

### Adjusting sensitivity

Set the sensitivity so that the relay will change state when the probes are in contact with the liquid. Then check that the relay returns to its initial position as soon as the probes emerge.

In certain applications, fine-tuning the sensitivity prevents inappropriate detection, such as the presence of foam or bubbles on the surface or the occurrence of leakage impedance between probes (extended line capacity, humidity, etc).

### Note :

Latching of the alarm relay R2 in de-energised state if a fault occurs can be programmed via a switch on the underside of the underside of the unit (only when the unit is switched off). To reset alarm relay R2, cut the power, as long as the levels are reset.

### Programming

The FN level controller can be programmed using 3 switches on the lower panel :

### Note :

Memory, Alarm and Function must only be selected when the unit is switched off.

# Level control

## → Electrode holders and level probes

### ■ Accessories for level control



### Specifications

Type	Accessories	Operating temperature (°C)	Pressure	Code
S8	A light, compact, 3-probe electrode holder (stainless steel). Electrode holder and 1000 mm probe. Particularly recommended for drinks vending machines and in cases where installation space is limited.	80	Max. : 2 kg/cm <sup>2</sup>	<b>79 696 044</b>
S3	Electrode holder with a single probe supplied in a standard length of 1000 mm. (304 stainless steel) Mounting with external 3/8" BSP thread and hexagonal head. Use 24 mm. spanner for hexagon. Suitable for use on boilers, autoclaves	≤ 200	Max. : 25 Kg/cm <sup>2</sup>	<b>79 696 014</b>
S7	Protected electrode for mounting by suspension. Protective shell : PUC (S7) Electrode : stainless steel Length of cable as requested (ref. C1) : 79 696 001			<b>79 696 043</b>
S5	Suitable for high pressures and high temperatures. Metal parts of stainless steel, isolated by ceramic. 3/8" BSP mounting thread.	≤ 350	Max. : 15 Kg/cm <sup>2</sup>	<b>79 696 006</b>

### Dimensions

#### 79 696 014 - S3

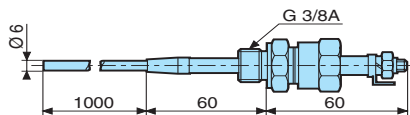

Electrode holder with a single probe supplied in a standard length of 1000mm. (304 stainless steel).

Mounting with external 3/8" BSP thread and hexagonal head.  
Use 24 mm. spanner for hexagon. Suitable for use on boilers, autoclaves and under high temperature conditions up to 200°C and high pressure conditions up to 25 kg/cm<sup>2</sup>

#### 79 696 043 - S7

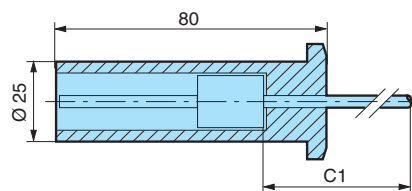

Protected electrode for mounting by suspension.  
Protective shell : PUC (S7)  
Electrode : stainless steel.  
Length of cable as requested (C1) : 79 696 001

#### S5

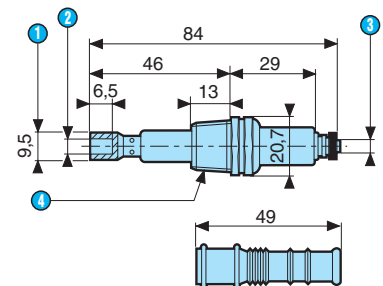

① 9.5 Across flats  
② 1/4 width  
③ 5/32 width  
④ 3/8 tapered NPT  
Suitable for high pressures and high temperatures. For use up to 350 °C and 15 kg/cm<sup>2</sup>.  
Metal parts of stainless steel, isolated by ceramic.  
3/8" BSP mounting thread.

#### 79 696 044 - S8

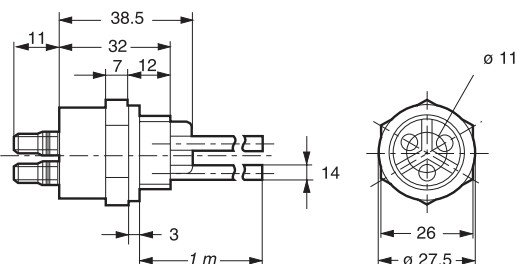

A light, compact, 3-probe electrode holder (stainless steel).  
Electrode holder and 1000 mm probe. Particularly recommended for drinks vending machines and in cases where installation space is limited.

Ambiente température : 80 °C  
Max. pressure : 2 kg/cm<sup>2</sup>

To order, see page 6

For more information [www.crouzet.com](http://www.crouzet.com)

# Phase control

## → EWS / EWS2 phase sequence and loss of phase

- Space savings, accurate measurement and optimized functions all improve the efficiency of your electrical installation.
- Control : You simply install your EWS phase control relay and without any adjustment you can monitor the loss or inversion of one of the phases.
- Safety : The EWS range enables you to choose the level of safety for your installation by using versions with 1, 2 or 3 output changeovers.
- Self-powered : Simple to install, EWS control relays use the controlled mains supply for their own power supply voltage.



### Specifications

Type	Output relay	Code
EWS	1 changeover	84 892 299
EWS2	2 changeovers	84 873 004

### General characteristics

Operating range	200 → 500 VAC
Operating range	3 AC 230...440 V
Frequency	50 / 60 Hz +/- 1 Hz
Maximum consumption	25 VA
<b>Output</b>	
Output relay	1 or 2 changeovers
Type of contacts	No cadmium
Nominal rating	8 A
Maximum breaking voltage	250 V AC
Max. voltage	440 V AC
Nominal breaking capacity	2000 VA
Min. breaking current	10 mA / 5 V
Electrical life (number of operations)	AC12 : 10 <sup>5</sup> operations at 8 A / 250 VAC.
Maximum rate (at full load)	360 operations /hour
Mechanical life (operations)	2 x 10 <sup>7</sup>
Pick-up delay T1	200 ms
Turn-off delay T2	300 ms in the event of phase failure
Connection capacity - without ferrule	2 x 2.5 mm <sup>2</sup> 1 x 4 mm <sup>2</sup>
Connection capacity - with ferrule	2 x 1.5 mm <sup>2</sup>
Max. tightening torque	1 Nm (screw M3 / IEC 947-1)
<b>Environment</b>	
Operating temperature range (°C)	-20 → +50
Storage temperature (°C)	-30 → +70
Material housing	Self-extinguishing
Protection (IEC 60529) - Casing	IP40
Protection (IEC 60529) - Term. block	IP20
Dielectric strength (IEC 60255-5)	2.5 KV / 1 mn / 1 mA / 50 Hz
Insulation coordination (IEC 60664-1)	Overvoltage category III, degree of pollution 3
Weight (g)	110

### Dimensions

#### EWS / EWS2

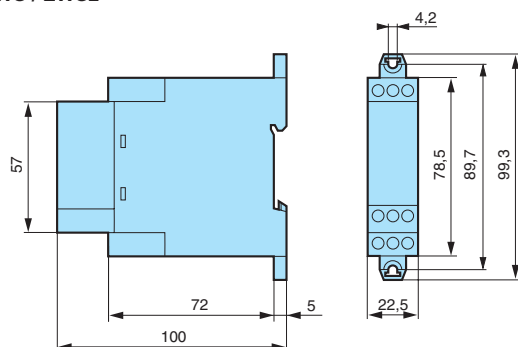

To order, see page 6



## Connections

### EWS

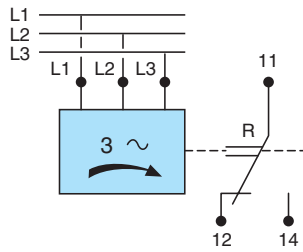

### EWS2

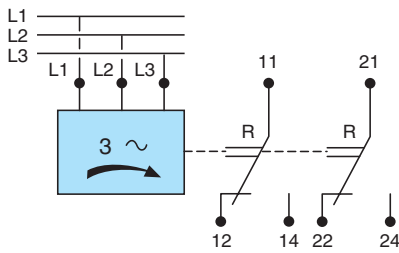

### EWS

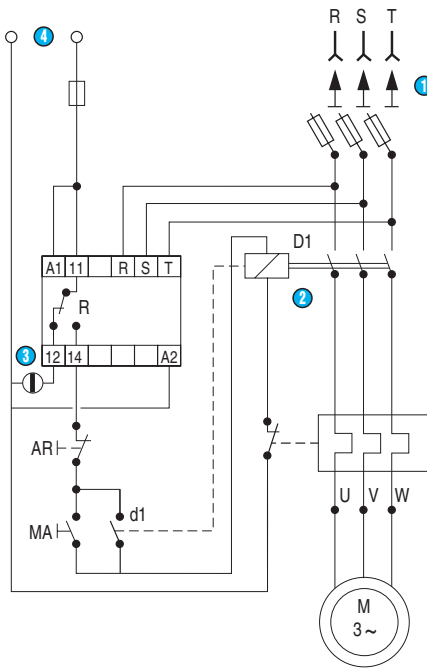

- ① Isolating switch
- ② Contactor
- ③ Alarm
- ④ Auxiliary power supply for contactor coil and signalling

### EWS

Monitoring of three-phase motor.  
Manual re-engage after disappearance of the fault.

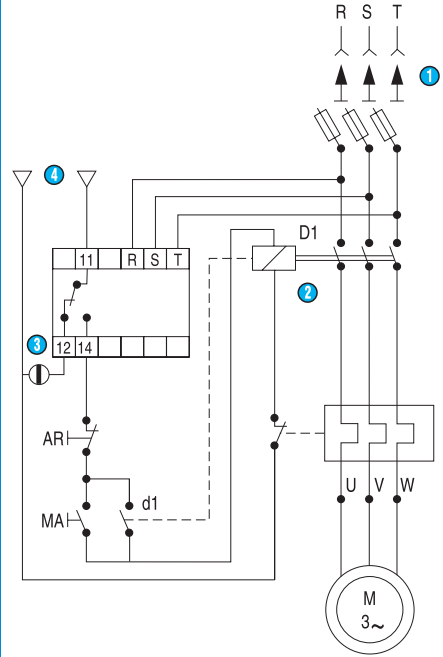

- ① Isolating switch
- ② Contactor
- ③ Alarm
- ④ Auxiliary power supply for contactor coil and signalling

## Principles

### Timing diagrams EWS

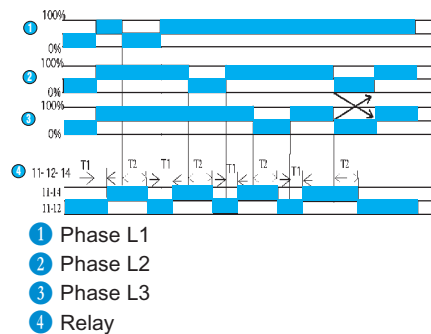

### Timing diagrams EWS2

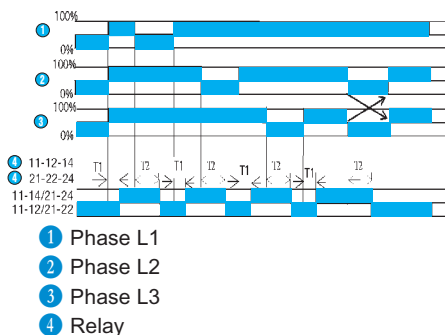

### Operating principle

EWS/EWS2 relays monitor the correct sequencing of phases L1, L2 and L3 as well as the loss of one of these phases.

When the phase sequence is correct, the output relay is energised, indicated by a yellow LED.

The relay de-energises (LED off) if one of the following faults occurs : Incorrect sequence of phases at terminals L1, L2 and L3

Total loss of one phase or all three phases (loss of phase detection threshold < 50 VAC)

# Phase control

## → EW2 / EWA2 phase asymmetry, sequence, loss or volt drop

- **Control :**
  - imbalance (asymmetry) between phases (for EWA2)
  - phase sequence
  - phase failure
  - voltage drop on one or more phases
- **Asymmetry rate can be adjusted on front face from - 5 % to +15 % of Un (for EWA2)**
- **3 x 230 V AC and 3 x 400 V AC power supply**
- **Dual frequency : 50 and 60 Hz.**
- **Indication of phase presence relay state by yellow LED**
- **Output relay : 2 x 8A changeover.**



### Specifications

Type	Voltage	Code
EW2	230 V AC	84 873 511
	400 V AC	84 873 512
EWA2	230 V AC	84 873 501
	400 V AC	84 873 502

### General characteristics

Input	
Nominal supply voltage range Un	3 V AC 230 V 3 V AC 400 V
Operating range	+15/ -20 % de Un
Frequency	50-60 Hz +/-1 Hz
Maximum consumption	17 VA at Un / 50 Hz (20 VA at 60 Hz) 23 VA at Un +15 % / 50 HZ (27 VA at HZ)
Output	
Output relay	2 changeovers
Type of contacts	No Cadmium
Nominal rating	8 A
Maximum breaking voltage	250 V AC / 440 V AC
Nominal breaking capacity	2000 VA
Min. breaking current	100 mA / 12 V
Electrical life (number of operations)	AC12 : 10 <sup>5</sup> operations at 8 A / 250 V AC
Maximum rate (at full load)	360 operations / hour
Mechanical life (operations)	2 x 10 <sup>7</sup>
Fault occurrence time T2	< 200 ms
Fault disappearance time T1	< 200 ms
Connection capacity - without ferrule	2 x 2.5 mm <sup>2</sup> 1 x 4 mm <sup>2</sup>
Connection capacity - with ferrule	2 x 1.5 mm <sup>2</sup>
Max. tightening torque	1 Nm (vis M3 / IEC 947-1)
Environment	
Operating temperature range (°C)	-20 → +50
Storage temperature (°C)	-40 → +70
Relative humidity (no condensation)	95 % HR
Material housing	Self-extinguishing
Protection (IEC 60529) - Casing	IP40
Protection (IEC 60529) - Term. block	IP20
Dielectric strength (IEC 60255-5)	2.5 KV / 1 mn / 1 mA / 50 Hz
Insulation coordination (IEC 60664-1)	Overvoltage category III, degree of pollution 3 : 4 KV / 3
Vibration (IEC 60068-2-6)	Amplitude : 0.35 mm peak Frequency : 10-55 Hz
Weight (g)	120

## Dimensions

EW2

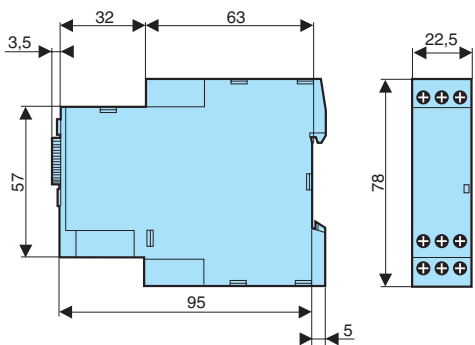

EWA2

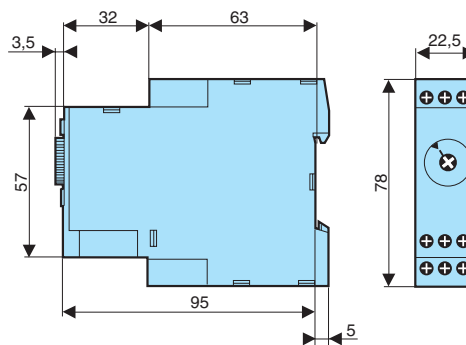

## Connections

EW2

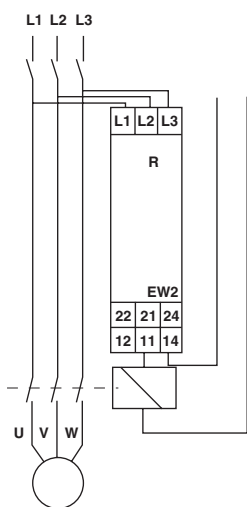

EWA2

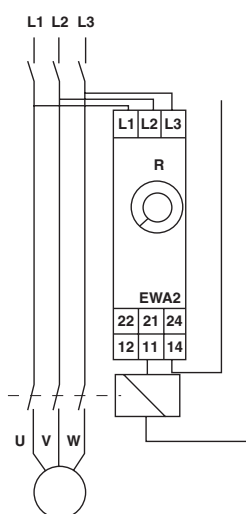

## Principles

EW2 / EWA2

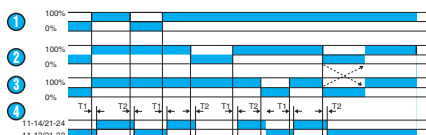

- ① Phase L1
- ② Phase L2
- ③ Phase L3
- ④ Relays

### Operating principle

EW2 relays monitor the correct sequencing of phases L1, L2 and L3 as well as a regeneration rate of 90 % : -10 % of  $U_n$  for EW2 relays.

When the phase sequence is correct, the output relay is energised, indicated by a yellow LED.

The relay de-energises (LED off) if one of the following faults occurs :

- Incorrect sequence of phases at terminals L1, L2 and L3,
- Voltage drop on one or more phases.

### Operating principle

EWA2 relays monitor the correct sequencing of phases L1, L2 and L3 as well as asymmetry rate of -5 to -15% of  $U_n$  for EWA2 relays.

When the phase sequence is correct, the output relay is energised, indicated by a yellow LED.

The relay de-energises (LED off) if one of the following faults occurs:

- Incorrect sequence of phases at terminals L1, L2 and L3
- Voltage drop on one or more phases.

# Phase control

## → FW phase sequence, loss or volt drop

- Controls :
  - phase sequence
  - loss of one or more phases
  - undervoltage
- Control power from sensed circuit
- Potentiometer for adjusting network voltage
- Time delay in the event of a fault adjustable : 0.2 to 10 s
- 2 x 8 changeover relay outputs
- Voltage and relay indication via 2 LEDs



### Specifications

Type	Voltages	Setting range	Code
FW	3 x 230 VAC	180 - 260 V AC	84 873 010
	3 x 380 VAC	310 - 440 V AC	84 873 011
	3 x 400 VAC	320 - 460 V AC	84 873 012
	3 x 415 VAC	330 - 480 V AC	84 873 013
	3 x 440 VAC	350 - 510 V AC	84 873 014
	3 x 480 VAC	380 - 550 V AC	84 873 015
	3 x 575 VAC	460 - 660 V AC	84 873 016

### General characteristics

#### Technical specifications

Supply	Self-powered L1 - L2 terminals
Operating range	0.7 • 1.2 x Un
Frequency (Hz)	50 / 60 Hz
Consumption	6 VA max.
Immunity from micro power cuts	10 ms
Delay on pick-up	500 ms
Insulation coordination	Category III Degree of pollution 2 according to IEC 664-1, VDE 0110 : 4 KV/2

#### Input circuit

Measurement input resistance	1 K $\Omega$ x Un
Regeneration rate	max 70 % of preset threshold
Under-voltage detection (symmetrical drop)	AC 20 % of preset threshold
Threshold display accuracy	$\pm$ 10 %

#### Output circuit

Output relay	2 AgCdO changeovers
Breaking capacity	2000 VA AC - 80 W DC
Maximum breaking current	8 A AC DC
Minimum breaking current	100 mA AC DC
Max. breaking voltage	250 V AC DC
Electrical life (A)	AC 12 : 2000 VA - 10 <sup>5</sup> operations AC 15 : cos $\phi$ = 0.3 - 6000 operations DC 13 : L/R = 300 ms - 6000 operations
Mechanical life (operations)	5 x 10 <sup>5</sup>
Maximum rate (at full load)	360 operations/h

#### General characteristics

Time delay in the event of a fault	0.2 to 10 s (0 • + 50 %)
Display voltage presence	green LED
Display Relay	yellow LED
Housing	Self-extinguishing
Terminals without ferrule	2 x 2.5 mm <sup>2</sup>
Terminals with ferrule	2 x 1.5 mm <sup>2</sup>
Terminals Tightening	0.6 mN max.
Temperature limit operation (°C)	-20 → +60
Temperature limits stored (°C)	-30 → +70
Relative humidity (no condensation)	93 %
Vibration Amplitude	0.35 mm
Vibration Frequency	10 - 55 Hz
Insulation resistance	> 100 M $\Omega$ sous 500 V
Approval UL and cUL	File E 87 133
Dielectric strength	3 kV at 1 mA for 1 minute/50Hz
Weight (g)	350

To order, see page 6

## Dimensions

FW

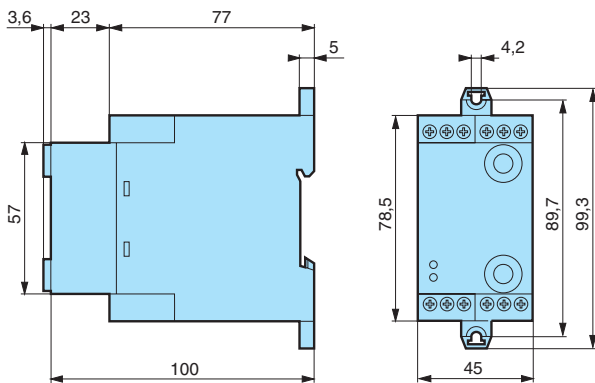

## Connections

FW

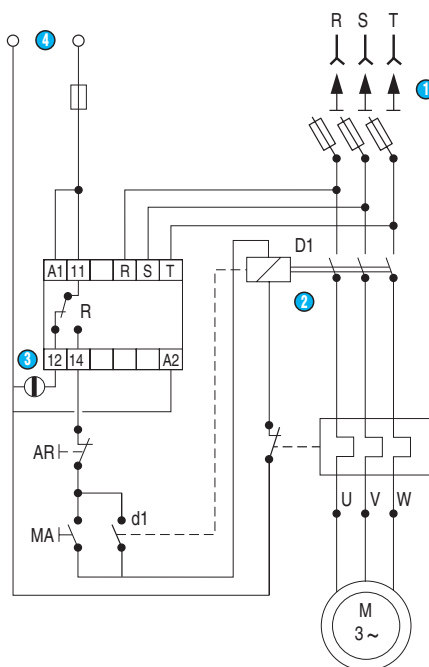

- ① Isolating switch
- ② Contactor
- ③ Alarm
- ④ Auxiliary power supply

FW

**Monitoring of three-phase motor.  
Manual re-engage after disappearance of the fault.**

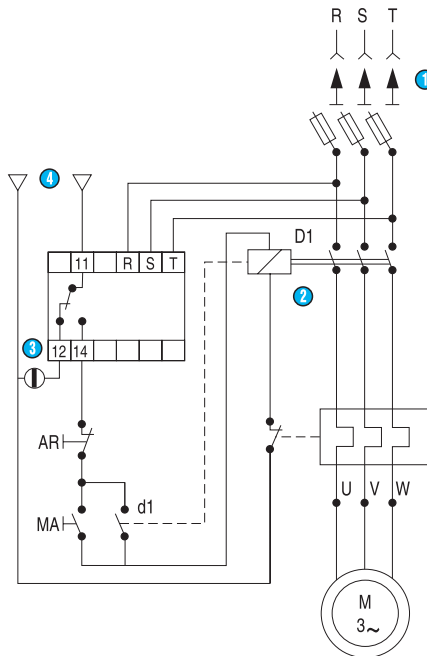

- ① Isolating switch
- ② Contactor
- ③ Alarm
- ④ Auxiliary power supply for contactor coil and signalling

FW

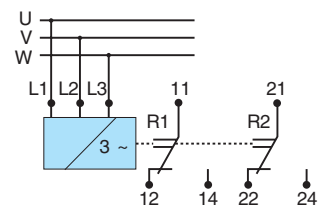

Terminal identification  
L1-L2-L3 3-phase network being monitored  
12-13-14 Output relay  
21-22-24 Output relay

## Principles

FW

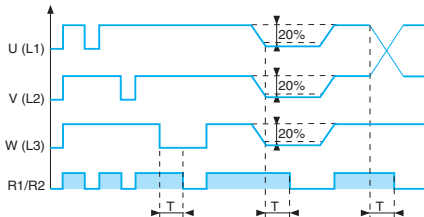

### Operating principle

In a 3-phase network, the FW simultaneously monitors phase sequencing, loss of phase with a maximum regeneration rate of 70 % of the voltage displayed by a potentiometer on the front face, and symmetrical voltage drop on the 3 phases of less than 20 % of the preset value.

When the 3 phases succeed on another, the output relay is activated and indicated via a yellow LED.

The output relay de-energises (LED off) after a time delay T, adjustable between 0.2 and 10 seconds on the front face, if one of the following faults is present :

- reversed direction of phase rotation,
- absence of one or more phases,
- voltage drop.

### Note :

Time delay T is not operational during loss of L1 and L2.

It operates during loss of L3, phase inversion or voltage drop. Its role is to prevent spurious triggering of output relays during transient states, notably during motor starting.

# Phase control

## → FWA/FWA2 phase asymmetry self-powered

- Controls :
  - imbalance (asymmetry) between phases,
  - phase sequencing
  - loss of phase with regeneration of 95 % of  $U_n$ .
- Asymmetry rate adjustable on front face (5 % to 20 %).
- Supply on 3-phase networks 3 x 230 V AC and 3 x 400 V AC.
- Dual frequency : 50 and 60 Hz.
- Presence of phases and state of relay indicated via 2 LEDs.
- Delay in the event of a fault adjustable from 0.5 to 10 seconds.
- Output relay : 2 8A changeover.



### Specifications

Type	Output	Supply voltage	Code
FWA	1 relay	3 x 230 VAC	84 873 300
		3 x 400 VAC	84 873 301
FWA2	2 relays	3 x 230 VAC	84 873 310
		3 x 400 VAC	84 873 311

### Principles

#### FWA / FWA2

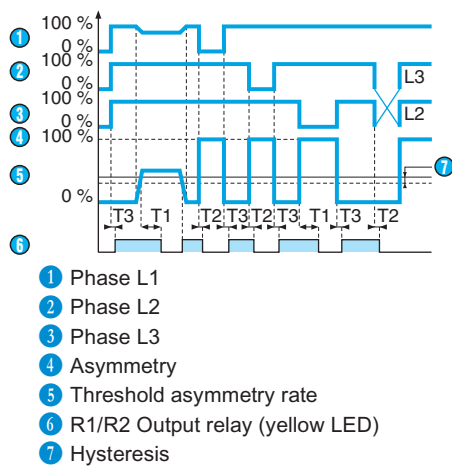

T1 : Delay in the event of a fault  
 T2 : Delay on power-down  
 T3 : Delay on power-up

#### Operating principle

The device is self-powered by two phases.

A green LED indicates the presence of the power supply voltage. When the phase sequence is correct and the asymmetry rate is lower than the threshold displayed on the front face, the output relay is energised, indicated by a yellow LED.

The output relay de-energises after a delay T1, adjustable from the front face, if one of the following faults is present :

- incorrect phase sequence,
- absence of L3,
- asymmetry rate higher than the threshold displayer. This imbalance represents the increase or decrease in the voltage of two phases compared to the voltage of a different phase.

The output relay de-energises instantaneously in the event of a break on L1 or L2.

A hysteresis fixed at approximately 10 % ensures bounce-free relay switching around the threshold.

As differential measurement is used, the FWA does not react to symmetrical increases or decreases in the network.

## General characteristics

### Technical specifications

#### Auxiliary power supply

Auxiliary voltage (self powered from terminals L1 and L2)	230 V AC, 400 V AC
Operating range	0.8 • 1.2 x Un
Frequency (Hz)	50 - 60 Hz
Consumption	4 VA max. to Un/8 VA to Un &plus ; 20 %
Immunity from micro power cuts	10 ms
Delay on power-up T3	1 s max.
Delay on power-down T2	300 ms max.
Insulation coordination	Installation category III, Degree of pollution 2, conforming to IEC 664-1, VDE 0110 : 4 KV/2

#### Input circuit

3-phase network Nominal voltage	FWA: 3 x 230 V AC FWA2: 3 x 400 V AC
3-phase network Operating range	FWA: 185 to 275 V AC FWA2: 320 to 480 V AC
Frequency (can be altered via switch underneath device)	50 and 60 Hz
Regeneration rate	Maximum 95 % Un
Adjustment of asymmetry rate	5 to 20 % Un
Threshold display accuracy (in accordance with VDE0435)	± 20 % at full scale
Temperature drift	0.1 % / °C
Repetition accuracy	± 1 % at full scale
Fixed hysteresis	10 % of displayed threshold

#### Output circuit

Output	volt-free changeover relay
Type of contacts	AgCdO
Breaking capacity	2000 VA - 80 W DC
Max. breaking current	8 V AC DC
Max. breaking voltage	250 V AC DC
Min. breaking current	100 mA AC DC
Electrical life AC 12	2000 VA - 10 <sup>5</sup> operations
Electrical life AC 15	Cos φ = 0.3 - 6000 operations
Electrical life AC 13	L/R = 300 ms - 6000 operations
Maximum rate	360 operations / hour at full load
Mechanical life (operations)	5 x 10 <sup>6</sup>

#### General characteristics

Time delay in the event of a fault T1	0.5 to 10 s (-0 + 60 %)
Display Power supply	green LED
Display Relay	yellow LED
Class of protection (529) - Term. block	IP 20
Class of protection (IEC 529) - Casing	IP 30
Material housing	Self-extinguishing
Mounting	Panel or DIN-rail mounted
Weight (g)	360
Tightening capacity of terminals	2 x 1.5 mm <sup>2</sup> with ferrule, 2 x 2.5 mm <sup>2</sup> without ferrule
Tightening torque (M3 screw / IEC 947.1)	0.6 Nm max
Temperature limits stored (IEC 68.2.1/2) °C	-20 °C • +60 °C
Relative humidity (acc. to IEC 68.2.30)	93 % (+ 2 % - 3 %) no condensation
Vibration (IEC 68.2.6) Amplitude	0.35 mm
Vibration (IEC68.2.6) Frequency	10 to 55 Hz
Insulation resistance (IEC 255.5)	> 100 mΩ at 500 V DC
Breakdown voltage according to IEC 255-5	2.5 KV / 1 mn / 1 mA / 50 Hz
Impulse voltage (IEC 255.5 /664.1)	5 KV / Wave 1.2 - 50 μs

## Dimensions

### FWA/FWA2

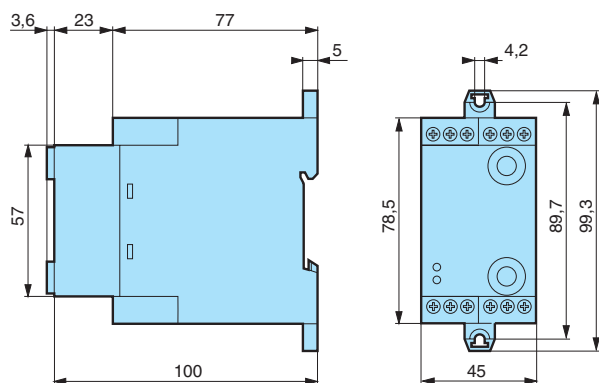

# Connections

FWA/FWA2

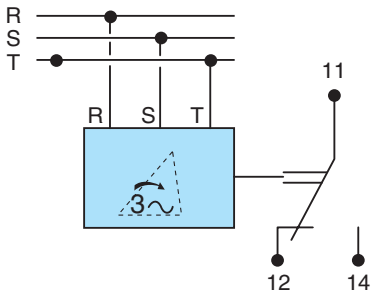

FWA/FWA2

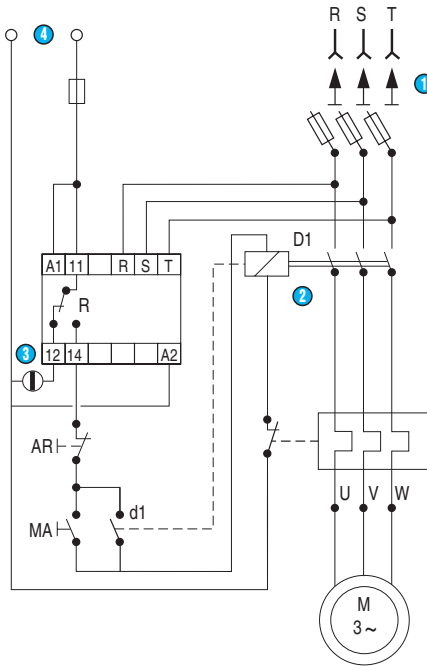

- ① Isolating switch
- ② Contactor
- ③ Alarm
- ④ Auxiliary power supply

FWA/FWA2

Monitoring of three-phase motor.  
Manual re-engage after disappearance of the fault.

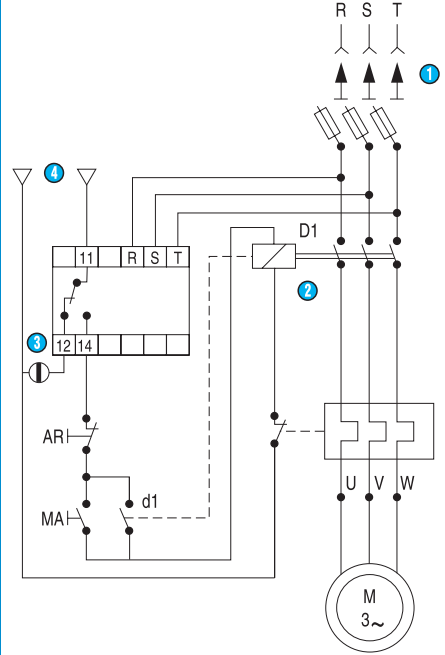

- ① Isolating switch
- ② Contactor
- ③ Alarm
- ④ Auxiliary power supply for contactor coil and signalling

FWA/FWA2

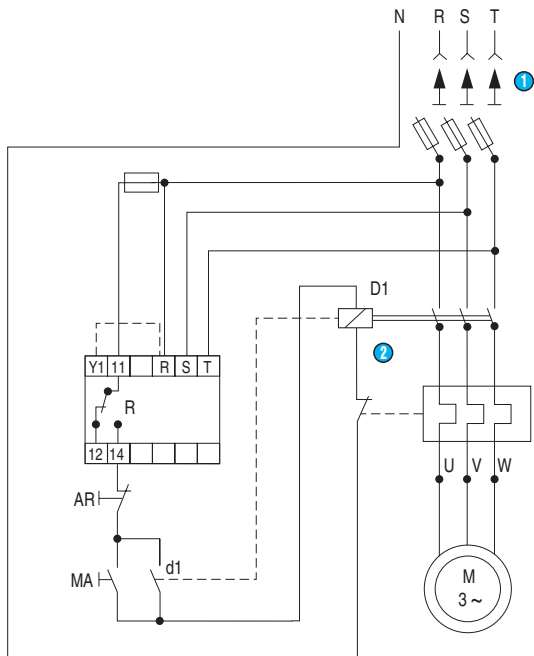

- ① Isolating switch
- ② Alarm

4





# Control with LCD display - Voltage - Current

## → HDU / HDI

- Displays the current value and the preset value on LCD
- Controls AC and DC signals (automatic detection)
- Selectable overload or underload mode
- Threshold and hysteresis can be adjusted separately
- Memory function in case of fault
- Delay on threshold crossing



Non available  
in Germany



Non available  
in Germany

## Specifications

	HDU - L	HDU - H	HDI - L	HDI - H
Measurement ranges	0.2 to 60 V	15 to 600 V	2 to 500 mA	0.1 to 10 A
<b>Supply voltage</b>				
24 DC	<b>84 872 301</b>	<b>84 872 306</b>	<b>84 871 301</b>	<b>84 871 306</b>
24 VAC	84 872 302	84 872 307	84 871 302	84 871 307
120 VAC	84 872 304	84 872 309	84 871 304	84 871 309
230 VAC	84 872 305	84 872 310	84 871 305	84 871 310
<b>Input circuits</b>	E1-M : 0.2 - 2 V E2-M : 1 - 10 V E3-M : 6 - 60 V	E1-M : 15 - 150 V E2-M : 30 - 300 V E3-M : 60 - 600 V	E1-M : 2 - 20 mA E2-M : 10 - 100 mA E3-M : 50 - 500 mA	E1-M : 0,1 - 1 A E2-M : 0,5 - 5 A E3-M : 1 - 10 A
<b>Input resistance</b>	E1-M : 2 kΩ E2-M : 10kΩ E3-M : 60kΩ	E1-M : 100 kΩ E2-M : 300 kΩ E3-M : 650 kΩ	E1-M : 5 Ω E2-M : 1 Ω E3-M : 0,2 Ω	E1-M : 0,1 Ω E2-M : 0,02 Ω E3-M : 0,01 Ω
<b>Maximum permanent voltage at 20 °C</b>	E1-M : 4 V E2-M : 20 V E3-M : 120 V	E1-M : 200 V E2-M : 350 V E3-M : 650 V	E1-M : 40 mA E2-M : 200 mA E3-M : 1 A	E1-M : 2 A E2-M : 10 A E3-M : 14 A
<b>Peak overload &lt; 1ms at 20 °C</b>	E1-M : 50 V E2-M : 100 V E3-M : 300 V	E1-M : 2 kV E2-M : 2 kV E3-M : 2 kV	E1-M : 1 A E2-M : 5 A E3-M : 8 A	E1-M : 17 A E2-M : 20 A E3-M : 50 A
<b>Max. line voltage</b>	Mains 277 / 480 VAC	Mains 277 / 480 VAC	Mains 277 / 480 VAC	Mains 277 / 480 VAC

## Dimensions

### HDI / HDU

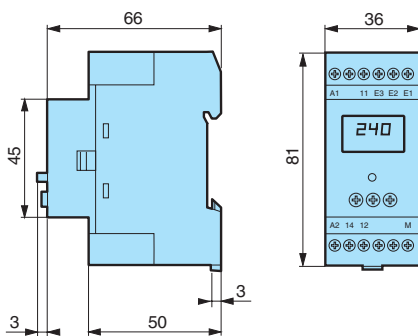

## General characteristics

### Supply

Supply voltage	230, 120, 24 V AC - 50 / 60 Hz 24 V DC no galvanic isolation protected against polarity reversal
Operating range	0.85 to 1.10 x Un
Maximum power consumption	3 VA at 230, 120 and 24 V AC 1 W at 24 VDC
Immunity from micro power cuts	10 ms
Delay on pick-up	500 ms
Insulation coordination	Category III Degree of pollution 2 according to IEC 664-1 VDE 0110 : 4 KV/2

### Output circuit

Output	1 AgCdO changeover relay - 5 A - 250 V
Minimum current	100 mA
Mechanical life (operations)	5 x 10 <sup>6</sup>
Maximum rate	360 operations / h at full load
Electrical life (A)	AC 12 : 1250 VA - 10 <sup>5</sup> operations AC 15 : cosφ = 0.3 - 6000 operations DC 13 : L/R = 300 ms - 6000 operations

### General characteristics

Delay on threshold crossing	0.1 to 3 sec ± 10 %
Display on LCD	Relay status OVER or UNDER mode Memory function Type of signal (AC or DC) Measurement overflow
Class of protection (529) - Term. block	IP 20
Protection class (IEC 529) - Panel-mounted	IP 40
Class of protection (IEC 529) - Casing	IP 50
Material housing	Self-extinguishing
Weight (g)	160
Terminal capacity	2 x 1.5 mm <sup>2</sup> with ferrule 2 x 2.5 mm <sup>2</sup> without ferrule
Tightening	0.6 mN max.
Temperature limits used (°C)	- 20 • + 60 °C
Temperature limits stored (°C)	-30 • +70 °C
Relative humidity (no condensation)	93 % (+2 % -3 %)
Dielectric strength	CEI 255.5, 2.5 KV / 1 min / 1 mA / 50 Hz
Hysteresis	Adjustable from 5 to 50 % of threshold
Frequency of measured signal	40 → 500 Hz
Threshold display accuracy	± 10 %
Repetition accuracy (with constant parameters)	±0.1 %
Drift Temperature	±0.05 % / °C
Drift Voltage	≤ 0.5 %

# Connections

## HDI / HDU

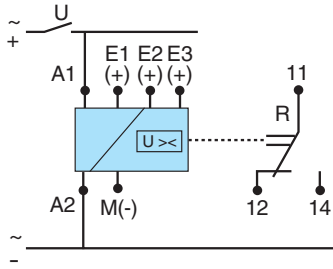

## HDU

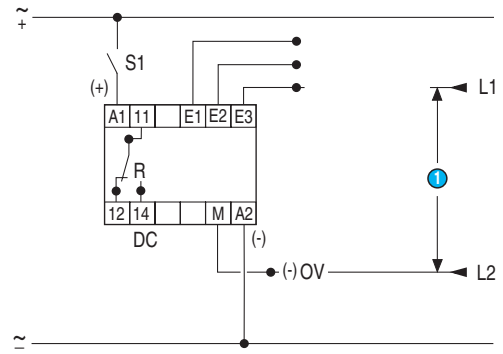

1 AC or DC voltage to be controlled

## HDI

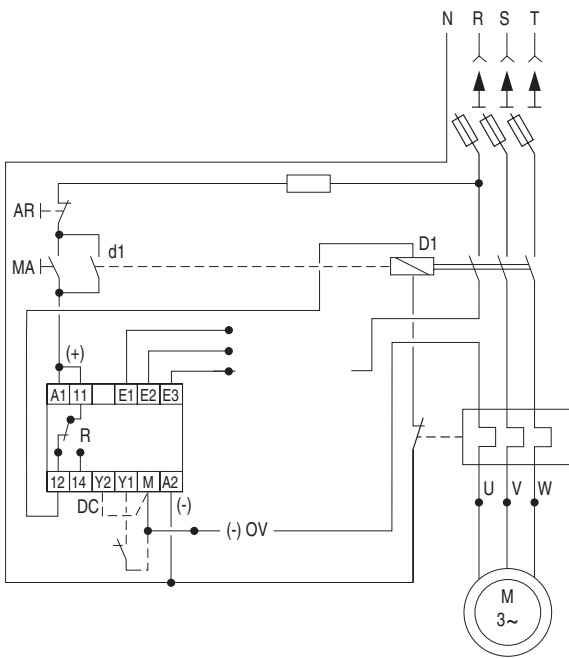

## Principles

### Operating principle

These devices are designed to control an AC or DC electrical signal : voltage using HDUs, current using HDIs.

The threshold and hysteresis can be adjusted separately via two potentiometers on the front face. Before powering up the device, the operating mode should be selected using two dipswitches located under the device (with/without memory, over/under value). The mode is validated when power is applied to terminals A1 - A2.

The signal to be monitored is connected between terminals E1, E2, or E3 (depending on the range) and terminal M.

### Control of voltage (HDU) or current (HDI) without memory

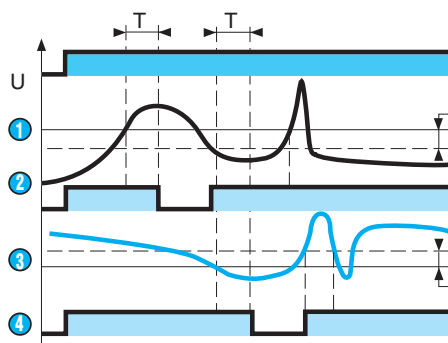

When the value of the controlled signal, AC or DC, reaches the threshold set on the front face, the output relay opens (failsafe) at the end of time delay T. It closes immediately when the signal goes below (or above in under value mode) the threshold minus hysteresis (plus hysteresis in under value mode).

#### Notes

The threshold crossing time delay T, which can be adjusted on the front face from 0.1 to 3 sec, ensures immunity to transients and other interference, thus preventing spurious triggering of the output relay.

In "under value" mode, the absolute value of the hysteresis cannot be more than the maximum of the measurement range.

- ① Threshold
- ② Oper. R Overload
- ③ Threshold
- ④ Oper. R Underload
- ⑤ Hysteresis

### Control of voltage (HDU) or current (HDI) with memory

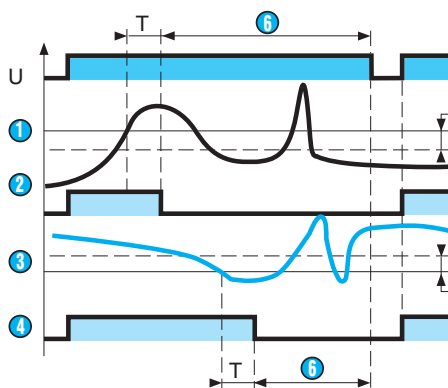

When the threshold is reached, the output relay opens at the end of time-out T and remains in that position.

To reset the relay, the supply must be cut.

This operating mode enables the detection of over or under values of short duration.

- ① Threshold
- ② Oper. R Overload
- ③ Threshold
- ④ Oper. R Underload
- ⑤ Hysteresis
- ⑥ Memory

# Current control

## → MCI AC current control

- Current transformer fitted by passing a cable through the front
- AC current threshold adjustable from 1 to 20 A AC (30 Hz to 400 Hz) via button on front
- Relay output 5 A - 250 V AC - 1N/O contact.
- Multivoltage power supply : 110 to 230 AC 50-60 Hz 24 V AC DC
- 17.5 mm casing clips on symmetrical DIN rail



### Specifications

Type	Supply voltage	Code
MCI	24 V AC DC / 110-240 VAC	84 871 102

### General characteristics

#### Characteristics

Supply voltage Un	24 V AC DC/110 - 240 V AC
Frequency (Hz)	50 / 60 Hz
Operating range	± 15 % for 24 V AC DC -15 % to 10 % of 110 V to 240 VAC
Maximum consumption	1 VA to 24 VAC 9 VA to 240 VAC 0.6 W to 24 VDC
Drift Temperature	0.06 % / °C
Repetition accuracy	0.45 %
Relative humidity	95 % HR

#### Input

Measured current range	from 1 A to 20 sinusoidal
Frequency range of measured current	from 30 Hz to 400 Hz
Display accuracy	± 10 % of the max. scale value
Switching hysteresis	15 % of the value displayed
Maximum permanent current	40 A
Accidental overload current	100 A / 3 s
Response time to sensing T2	400 ms ± 50 %
Response time to sensing T3	120 ms ± 50 %
Delay on pick-up T1	500 ms maximum

#### Output circuit

Output	One normally open contact
Breaking capacity	1250 VA
Maximum breaking current	5 A AC DC
Minimum breaking current	10 mA AC DC
Max. breaking voltage	250 V AC DC
Electrical life (A)	10 <sup>5</sup> operations to 1250 VA resistive
Mechanical life (operations)	30 x 10 <sup>6</sup>
Type of contacts	AgCdO
Tightening capacity of terminals	2 x 1.5 mm <sup>2</sup> with ferrule or 2 x 2.5 mm <sup>2</sup> without ferrule
Temperature limit operation (°C)	-20 °C → +60 °C
Temperature limits stored (°C)	-30 °C → +70 °C
Weight (g)	80
Dielectric strength	2.5 KV / 1 mn / 1 mA / 50 Hz (CEI 255.5)

## Dimensions

MCI

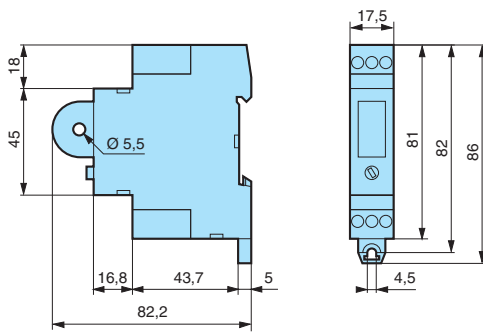

## Connections

MCI

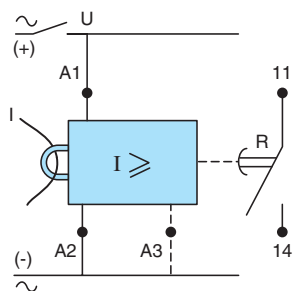

A1 - A2 : Power supply 110...240 VAC  
A1 - A3 : Power supply 240 VAC

## Principles

MCI

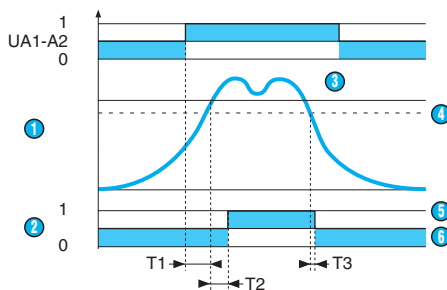

- ① threshold
- ② Relay
- ③ Amplitude of measured current
- ④ Hysteresis = Threshold - 15 %
- ⑤ Closed
- ⑥ Open

### Operating principle

The relay contact (11 and 14) closes if the current is greater than the threshold.  
The relay contact (11 and 14) opens if the current is less than 15 % (hysteresis) of the threshold.

### Note :

Delay on pick-up (T1) 500 ms maximum. Response time to sensing (T2) 400 ms  $\pm$  50 %.  
Response time to turn-off (T3) 120 ms  $\pm$  50 %.

The graduated set-point scale on the front relates to sinusoidal or delta current measurement. The MCI can measure non-sinusoidal currents, for example currents subject to phase control. In this case, the display may be affected by an error coefficient which is a function of the tripping angle of the phase controller (form factor).

# Current control

## → EI AC/DC current control

- Space savings, accurate measurement and optimized functions all improve the efficiency of your electrical installation.
- Control : Select "Over-current" or "Under-current" control mode, by means of a dip switch on the underside of the unit.
- Safety : Choose whether or not to activate the fault memorisation function, and set the threshold crossing delay T1 and the inhibit time delay T2 in the same way. In addition, AC/DC mode is detected automatically.
- Accuracy : 3 products, EIL, EIH or EIT enable you to choose the best product for greater accuracy of measurement, provided by a microcontroller.



### Specifications

	EIL	EIH	EIT
<b>Supply voltage</b>			
24 V DC	84 871 020	84 871 030	84 871 040
24 V AC	84 871 021	84 871 031	84 871 041
48 V AC	84 871 022	84 871 032	84 871 042
120 V AC	84 871 023	84 871 033	84 871 043
230 V AC	84 871 024	84 871 034	84 871 044
<b>Measurement range</b>	2 → 500 mA	0.1 → 10 A	10 → 100 A with current transformer
<b>Inputs</b>	E1-M E2-M E3-M	E1-M E2-M E3-M	E1-M
<b>Sensitivity</b>	E1-M : 2 → 20 mA E2-M : 10 → 100 mA E3-M : 50 → 500 mA	E1-M : 0.1 → 1 A E2-M : 0.5 → 5 A E3-M : 1 → 10 A	10 → 100 A
<b>Input resistance</b>	E1-M : 5 Ω E2-M : 1 Ω E3-M : 0.2 Ω	E1-M : 0.1 Ω E2-M : 0.02 Ω E3-M : 0.01 Ω	20 Ω

### Accessories

	Code
Current transformers for EIT 100 A / 50 mA	26 852 304

### General characteristics

Supply voltage Un	230 V, 110 V, 48 V, 24 V ac 50 / 60 Hz (galvanic isolation by transformer) 24 V DC (No galvanic isolation). In this case, the product power supply and measuring circuit power supply must be electrically isolated.
Operating range	0.85 → 1.15 Un
Maximum power consumption	3 VA AC 1 W DC
Frequency of measured signal	40 → 500 Hz
Adjustable hysteresis	5 → 50 % of the displayed threshold
Threshold value	10 → 100 % of the measurement range
Display accuracy of the preset threshold	±10 %
Repetition accuracy with constant parameters	±0.1 %
Drift Voltage	±0.1 % (±10 % Un)
Drift Temperature	±0.02 %
Delays on power up (T2)	1 s → 20 s ±10 %
Delay on energisation T1	0.1 s → 3 s ±10 %
Delay on pick-up	500 ms
Output relay	1 changeover AgNi, 8A AC max
Temperature limit operation (°C)	-20 → +50
Temperature limits stored (°C)	-40 → +70
Weight (g)	140

To order, see page 6



## Dimensions

EIL / EIH / EIT

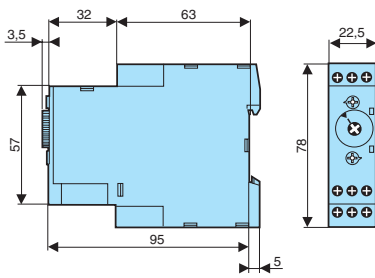

## Connections

EIL / EIH

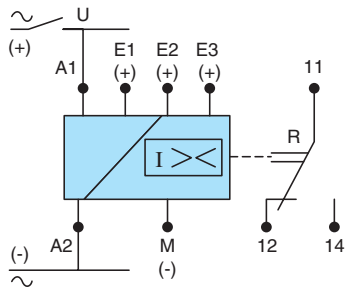

EIT

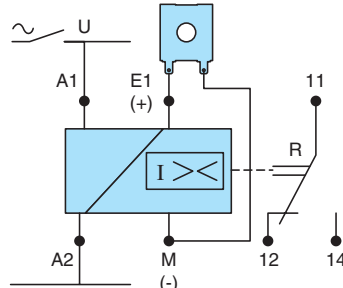

A1 - A2 : Supply voltage

## Principles

AC/DC control with memory

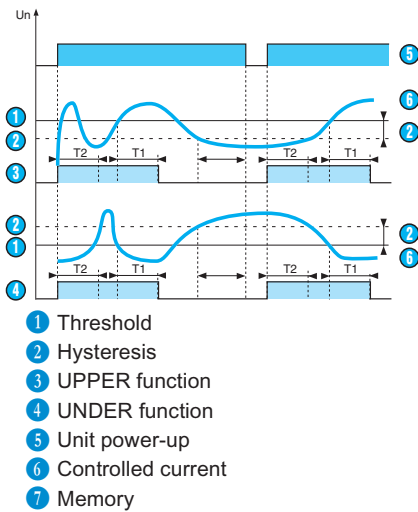

Operating principle

### AC/DC control without memory

When the value of the controlled current, either AC or DC, reaches the threshold displayed on the front face, the output relay changes state at the end of time delay T1. It returns instantly to the initial state when the current drops below the hysteresis threshold, or when the power supply is disconnected.

### AC/DC control with memory

The output relay changes state at the end of time delay T1 and remains latched in this position. To reset the memory function the auxiliary supply must be disconnected.

### Over-current function (UPPER)

The time delay on energisation T2 prevents current peaks due to motor starting. The delay on upward crossing of threshold T1 provides immunity to transients and other interference, thereby preventing spurious triggering of the output relay.

### Under-current function (UNDER)

The time delay on energisation T2 prevents the occurrence of current troughs. The delay on downward crossing of threshold T1 provides immunity to random dips, thereby preventing spurious triggering of the output relay.

**Note :** In underload function, the absolute value of the hysteresis cannot be greater than the measurement range maximum.

AC/DC control without memory

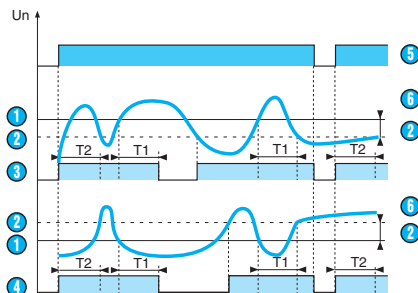

- 1 Threshold
- 2 Hysteresis
- 3 UPPER function
- 4 UNDER function
- 5 Unit power-up
- 6 Controlled current

# Voltage control

## → EUL/EUH AC/DC voltage control

- Voltage monitoring
- 2 relays to cover 6 ranges of measurement : 0.2V to 600V
- Automatic recognition AC/DC
- Frequency up to 500 Hz



### Specifications

	EUL	EUH
<b>Supply voltage</b>		
24 V DC	84 872 020	84 872 030
24 V AC	84 872 021	84 872 031
120 V AC	84 872 023	84 872 033
230 V AC	84 872 024	84 872 034
<b>Measurement range</b>	0.2 → 60 V	15 → 600 V
<b>Input</b>	E1-M E2-M E3-M	E1-M E2-M E3-M
<b>Sensitivity</b>	E1-M : 0,2 to 2V E2-M : 1 to 10V E3-M : 6 to 60V	E1-M : 15 to 150V E2-M : 30 to 300V E3-M : 60 to 600V
<b>Input resistance</b>	E1-M : 2kΩ E2-M : 10kΩ E3-M : 60kΩ	E1-M : 100kΩ E2-M : 300kΩ E3-M : 600kΩ

### General characteristics

Supply voltage $U_n$	24 V, 120 V, 230 V, 50/60 Hz (galvanic isolation via transformer) 24 V (no galvanic isolation). In this case, the product power supply and measuring circuit power supply must be electrically isolated.
Operating range	0.85 1.15 $U_n$
Maximum power consumption	3 VA / 1 W
Frequency of measured signal	40 500 Hz
Threshold $U_e$	Adjustment from 10 to 100 % of the measurement range
Hysteresis	Adjustment from 5 to 50 % of the displayed threshold
Display accuracy	± 10 % of the full scale
Delay on energisation T1	0.13 s ±10 %
Output relay	1 AgNi changeover, 8 A max
Temperature Use (°C)	-20 → +60
Storage temperature (°C)	-30 → +70

### Dimensions

#### EUL / EUH

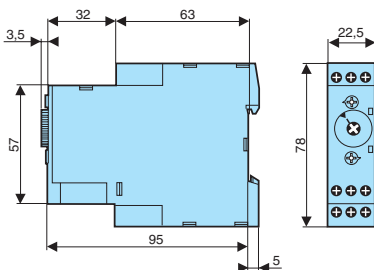

To order, see page 6

## Connections

### EUL

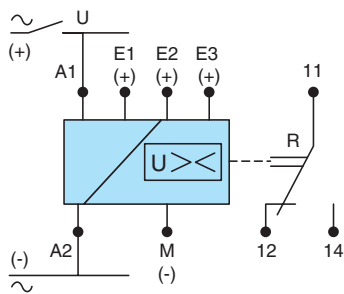

A1 - A2 : Supply voltage

### EUL / EUH

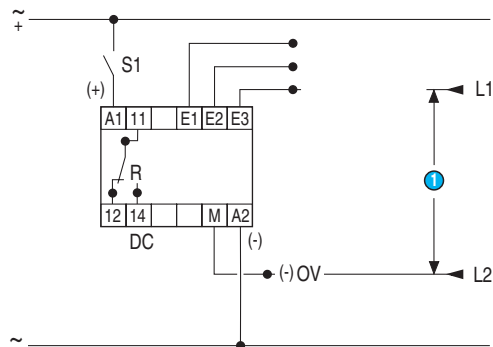

① Supply voltage to be monitored

## Principles

### Control of AC/DC voltage without memory

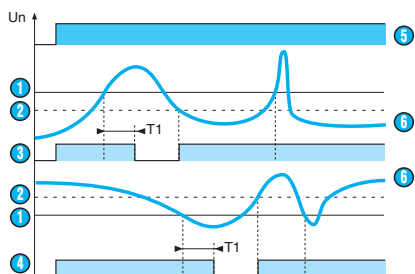

When the value of the controlled voltage, AC or DC, reaches the threshold  $U_e$  displayed on the front face, the output relay changes state at the end of a time delay  $T_1$ , which can be set on the front face at between 0.1 and 3s.

Once the voltage drops below 5 to 50 % of the threshold (hysteresis), the output relay changes state again instantly. Changing the hysteresis on the front face does not therefore modify the value of the preset threshold.

- ① Threshold  $U_e$
- ② Hysteresis
- ③ UPPER function
- ④ UNDER function
- ⑤ Unit power-up
- ⑥ Controlled voltage

### Control of AC/DC voltage with memory

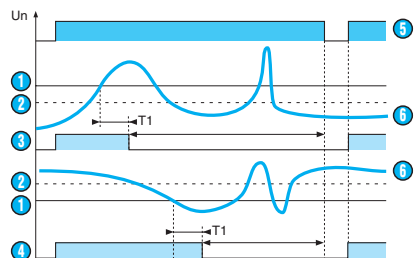

When the value of the controlled voltage, AC or DC, reaches the threshold  $U_e$  displayed on the front face, the output relay changes state at the end of a time delay  $T_1$ , which can be set on the front face at between 0.1 and 3s and remains latched in this position.

- ① Threshold  $U_e$
- ② Hysteresis
- ③ UPPER function
- ④ UNDER function
- ⑤ Unit power-up
- ⑥ Controlled voltage
- ⑦ Memory

# Voltage control

## → EUS/EUSF AC/DC voltage control with memory function

- Control their own supply
- Automatically detect the AC or DC signal
- EUS for the control of over/under voltage (selectable)
- EUSF for the control between 2 values (window function)
- Fault memory selectable



### Specifications

	EUS	EUSF
<b>Supply voltage</b>		
12 V DC	<b>84 872 040</b>	
20-80 V AC/DC	<b>84 872 046</b>	<b>84 872 056</b>
65-260 V AC/DC	<b>84 872 047</b>	<b>84 872 057</b>
<b>Supply voltage</b>	7.5 to 18 V DC 15 to 150 V AC/DC 50 to 275 V AC/DC with protection against connection errors	20 to 80 V AC/DC 65 to 260 V AC/DC with protection against connection errors
<b>Threshold Ue</b>	Direct adjustment 9.6 to 15.6 V DC 20 to 80 V AC/DC 65 to 260 V AC/DC	Adjustable from 20 to 80 V AC/DC 65 to 260 VAC/DC
<b>Hysteresis</b>	Adjustment from 5 to 20 %	Fixed 5 %
<b>Display</b>	Green LED : Supply Fixed yellow LED : relay state over voltage High LED : relay state	Fixed yellow LED : Relay state over voltage Flashing yellow LED : Relay state undervoltage

### General characteristics

Maximum power consumption	0.5 W at 12 V DC 0.5 VA at 80 V and 260 VAC 1.5 W at 80 V and 260 V AC
Frequency of measured signal	50/60 Hz
Display accuracy (of the full scale)	± 10 %
Delay on upward crossing of threshold	0.13 s ± 10 %
Output relay	1 AgNi changeover 8 A max
Temperature Use (°C)	-20 → +60
Storage temperature (°C)	-30 → +70

### Dimensions

#### EUS / EUSF

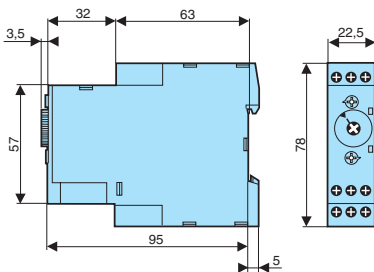

To order, see page 6

## Connections

### EUS / EUSF

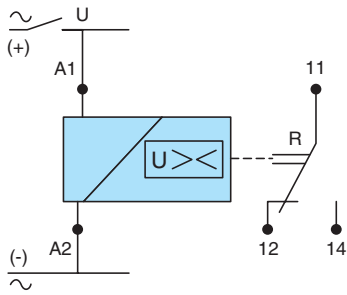

### EUS / EUSF

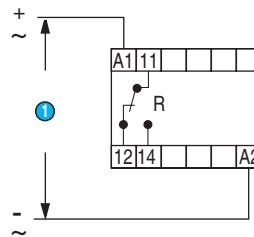

- ① Supply voltage to be monitored

## Principles

### EUS: voltage control without memory

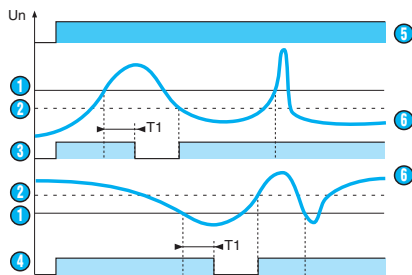

- ① Threshold  $U_e$
- ② Hysteresis
- ③ UPPER function
- ④ UNDER function
- ⑤ Unit power-up
- ⑥ Controlled voltage

### EUS: voltage control with memory

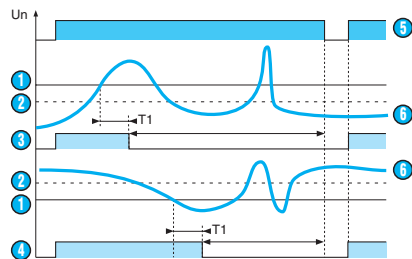

- ① Threshold  $U_e$
- ② Hysteresis
- ③ UPPER function
- ④ UNDER function
- ⑤ Unit power-up
- ⑥ Controlled voltage
- ⑦ Memory

### EUSF

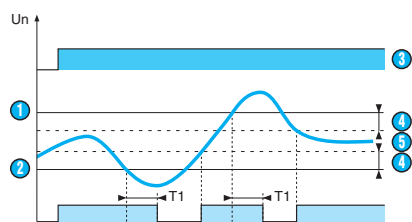

- ① High threshold
- ② Low threshold
- ③ Unit power-up
- ④ Hysteresis
- ⑤ Controlled voltage

### Operating principle

**EUS** - The operating principle of the EUS control relays is identical to that for the EU control relays.

- Two operating mode are available :
- AC / DC voltage control without memory
  - AC / DC voltage control with memory

**Note** : Time delay T1 on crossing the upper and lower thresholds provides protection to transients, thus preventing spurious triggering of the output relay.

### Operating principle

**EUSF** - The EUSF window threshold relay controls an electrical voltage which acts as its own power supply (simplified wiring). When the value of the controlled voltage, AC or DC, goes outside the window, the output relay de-energises at the end of a time delay T1 which can be set on the front face at between 0.1 and 3s.

It switches back on when the voltage returns within the window and stays between the upper and lower thresholds displayed by two potentiometers on the front face. Fixed hysteresis ensures bounce-free relay switching around the threshold.

**Note** : Time delay T1 on crossing the upper and lower thresholds provides protection to transients, thus preventing spurious triggering of the output relay.

# Voltage control

## → F3US / F3USN 3-phase voltage control

- Controls over- and undervoltages on own power supply (window-type).
- F3US : phase-to-phase / F3USN : phase and neutral.
- Minimum and maximum thresholds can be adjusted separately
- Detects absence of neutral on F3USN.
- Delay on crossing upper or lower threshold adjustable between 0.1 and 10 sec. on front face.
- 2 yellow LEDs indicate over- and undervoltages.
- 1 green LED indicates presence of power supply.
- 2 output relays : high and low threshold.
- 2 separate time delays.



### Specifications

Type	Supply voltage	Lower treshold	Upper treshold	Code
F3US	3 x 230 V AC	195 to 225	235 to 264	84 873 200
	3 x 400 V AC	340 to 392	408 to 460	84 873 201
F3USN	3 x 230 V AC	112 to 130	135 to 152	84 873 210
	3 x 400 V AC	195 to 225	235 to 264	84 873 211

### General characteristics

#### Power supply characteristics

Supply voltage Un on terminals L1 - L2	230 and 400 V AC $\pm$ 20 % -50 / 60 Hz
Power (W)	4 VA maximum to Un 8 VA maximum to Un +20 %
Delay on pick-up	Approximately 3 s
Immunity from micro power cuts	10 ms
Insulation coordination	Installation category III, degree of pollution 2 conforming to IEC 664.1 / VDE 0110 : 4 KV/2

#### Control circuit characteristics

Adjustment of upper threshold	102 to 155 % of Un
Adjustment of lower threshold	85 to 98 % of Un
Fault delay	0.1 to 10 sec (0, +50 %)
Hysteresis	Approximately 3 %
Display accuracy	$\pm$ 10 %
Repetition accuracy	upper threshold : 0.06 %, lower threshold : 0.09 %
Drift Temperature	$\pm$ 0.05 % / °C

#### Output characteristics

Output	2 AgCdO changeover
Breaking capacity	2000 VA - 80 W
Maximum breaking current	8 A AC DC
Max. breaking voltage	250 V AC DC
Minimum breaking current	100 mA AC DC
Mechanical life (operations)	30 x 10 <sup>6</sup>
Electrical life AC 12	2000 VA - 10 <sup>6</sup> operations
Electrical life AC 15	Cos $\phi$ = 0.3 - 6000 operations
Electrical life AC 13	L/R = 300 ms - 6000 operations

#### General characteristics

Delay on threshold crossing	0.1 to 10 s (0 $\pm$ 50 %)
Display Powr supply	Green LED
Display overvoltage relay	Yellow LED
Display undervoltage relay	Yellow LED
Class of protection (529) - Term. block	IP 20
Class of protection (IEC 529) - Casing	IP 50
Material housing	Self-extinguishing
Mounting	Panel or DIN-rail mounted
Weight (g)	310
Tightening capacity of terminals	2 x 1.5 mm <sup>2</sup> with ferrule 2 x 1.5 mm <sup>2</sup> without ferrule
Tightening torque	0.6 Nm maximum (M3 screw / IEC 947-1)
Temperature limits Use (IEC 68.2.14) °C	-20 °C $\rightarrow$ +60 °C
Temperature limits stored (IEC 68.2.1/2) °C	-30 °C $\rightarrow$ +70 °C
Relative humidity (acc. to IEC 68.2.30)	93 % (+ 2 % ; - 3 %) no condensation
Vibration (IEC 68.2.6) Amplitude	0.35 mm
Vibration (IEC68.2.6) Frequency	10 to 55 Hz
Insulation resistance (IEC 255.5)	> 10 M $\Omega$ at 500 V DC
Breakdown voltage according to IEC 255-5	> 2.5 kV / 1 mn / 1 mA / 50 Hz
Impulse voltage (IEC 255.5 /664.1)	5 kV / Wave 1.2 - 50 $\mu$ s

To order, see page 6

## Dimensions

### F3US / F3USN

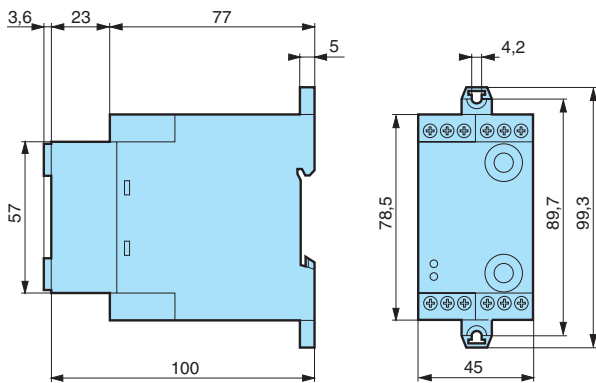

## Connections

### F3US

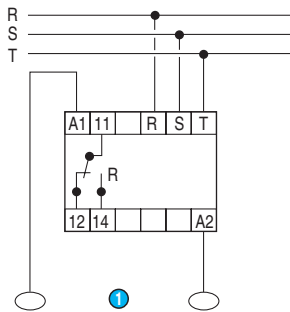

① Auxiliary power supply

### F3USN

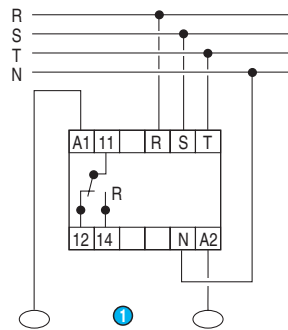

① Auxiliary power supply

### F3US

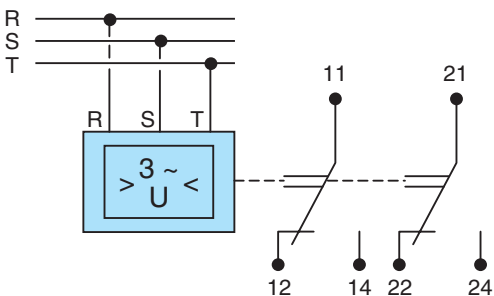

L1 - L2 - L3 : 3-phase network being monitored  
 11 - 12 - 14 : Output relay (R1) lower threshold  
 21 - 22 - 24 : Output relay (R2) upper threshold

### F3USN

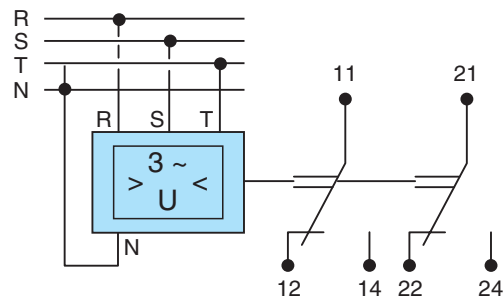

## Principles

### F3US / F3USN

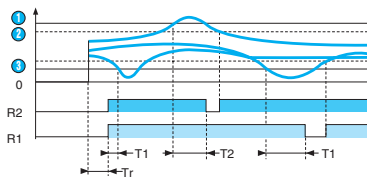

- ① 3-phase network
- ② Upper threshold
- ③ Lower threshold

### Operating principle

The two relays are energised when the measured voltages are between the minimum and maximum thresholds which can be separately adjuste via two potentiometers on the front face. If one or more voltages goes outside the window, the relay corresponding to the fault de-energises following a delay which can be adjusted on the front face. The relays each have individual delays (0.1 to 10 sec.).

A hysteresis fixed at 3 % ensures bounce-free relay switching when the voltage levels return to a value between the upper and lower thresholds.

The unit is not affected by the phase sequence nor by harmonic distortion.

A green LED indicates the presence of the power supply voltage. Two yellow LEDs indicate when the upper and lower thresholds have been exceeded.

The LEDs go out when the voltages are within the set window.

# Motor control

## → FFP motor load (cosine $\phi$ ) control

- Self-powered
- Controls motor overload and underload
- Measures the phase shift between the current and the voltage (cosine  $\phi$ )
- Independent adjustment of min. and max. thresholds from 0.1 to 0.99
- Power-on inhibit time adjustable between 0.5 and 20 sec.
- Fault delay adjustable between 0.3 and 3 sec.
- 2 output relays (one per threshold).
- LEDs indicate power supply and state of output relays.



### Specifications

Type	Supply voltage	Code
FFP	3 x 230 VAC	84 873 400
	3 x 400 VAC	84 873 401
	3 x 440 VAC	84 873 402
	3 x 480 VAC	84 873 403
	3 x 575 VAC	84 873 404

### General characteristics

#### Power supply characteristics

Supply voltage $U_n$	230, 400, 440, 480, 575 V AC - 50/60 Hz Self-powered via L1 and L2
Operating range	0.85 to 1.15 $U_n$
Nominal power	2 VA to $U_n$
Maximal power	3 VA to $U_n + 15\%$
Immunity from micro power cuts	10 ms
Insulation coordination	Category III, degree of pollution 2 conforming to IEC 664.1 / VDE 0110 : 4 KV/2

#### Control / input circuit characteristics

Threshold display	0.1 to 0.99
Voltage input circuit resistance	approx. 2 k $\Omega$ ( $U_n$ )
Current measurement	by internal shunt via 2 terminals
Current range	0.5 to 10 A
Input resistance	20 m $\Omega$
Maximum permanent current	14 A (20 °C)
Peak overload	50 A (< 1 s) (20 °C)
Delays on power up (T2)	0.5 to 20 s - $\pm 20\%$ of full scale
Delay on energisation T1	0.3 to 3 s - $\pm 20\%$ of full scale
Frequency (Hz)	50 / 60 Hz
Hysteresis	10 % fixed for $\text{Cos}\phi \geq 0.4$ 10 % < Hyst. < 30 % for $\text{Cos}\phi < 0.4$
Display accuracy	$\pm 10\%$ of full scale
Repetition accuracy	$\pm 0.8\%$ with constant parameters
Drift Temperature	$\pm 0.05\%$ / °C

#### Output characteristics

Output	2 AgCdO changeover
Breaking capacity	2000 VA - 80 W
Maximum breaking current	8 A AC DC
Minimum breaking current	100 mA AC DC
Max. breaking voltage	250 V AC DC
Mechanical life (operations)	30 x 10 <sup>6</sup>
Electrical life AC 12	200VA - 10 <sup>5</sup> operations
Electrical life AC 15	$\text{Cos}\phi = 0.3$ - 6000 operations
Electrical life AC 13	L/R = 300 ms - 6000 operations

#### General characteristics

Material housing	Self-extinguishing
Terminal capacity	2 x 1.5 mm <sup>2</sup> with ferrule 2 x 2.5 mm <sup>2</sup> without ferrule
Temperature limit operation (IEC 68.1.14) (°C)	-20 → +60
Temperature limits stored (IEC 68.1.1/2) (°C)	-30 → +70
Relative humidity (no condensation)	93 % (+2 % ; -3 %)
Weight (g)	360



## Dimensions

### FFP

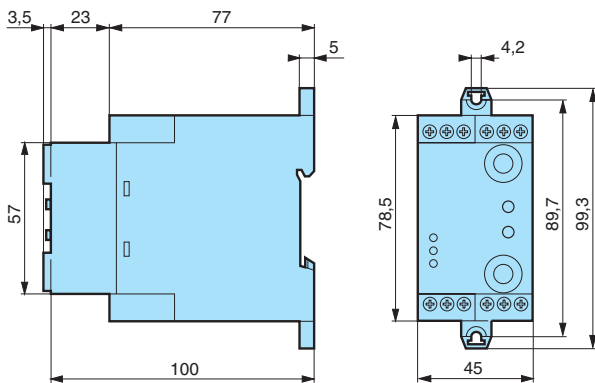

## Connections

### FFP

#### Operation on 3-phase network I < 10 A AC

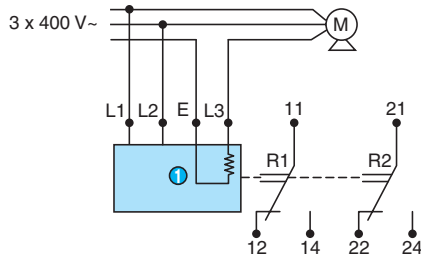

① Internal shunt

L1 - L2 - L3 : Network to be monitored  
 E : Current read output  
 11 - 12 - 14 : Low threshold output relay (R1)  
 21 - 22 - 24 : High threshold output relay (R2)

### FFP

#### Operation on 3-phase network I > 10 A AC

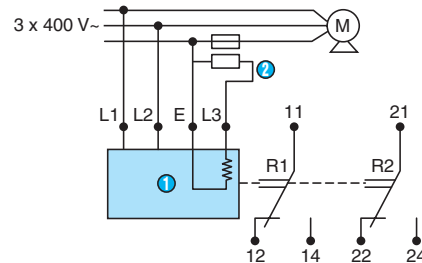

① Internal shunt  
 ② External current transformer

L1 - L2 - L3 : Network to be monitored  
 E : Current read output  
 11 - 12 - 14 : Low threshold output relay (R1)  
 21 - 22 - 24 : High threshold output relay (R2)

### FFP

#### Operation on single phase network 230 V AC

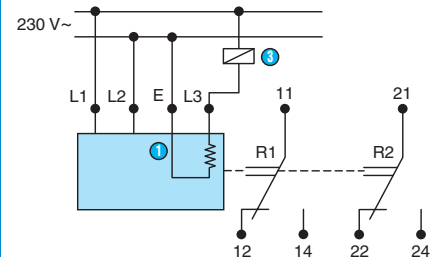

① Internal shunt  
 ② Charge

L1 - L2 - L3 : Network to be monitored  
 E : Current read output  
 11 - 12 - 14 : Low threshold output relay (R1)  
 21 - 22 - 24 : High threshold output relay (R2)

## Principles

### FFP

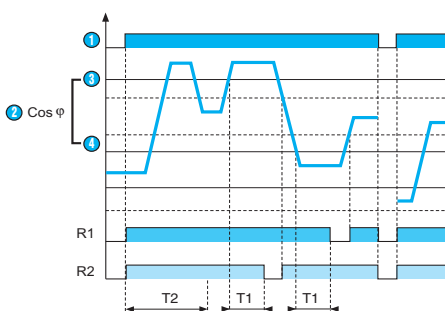

① 3-phase network  
 ② Cos φ  
 ③ Maximum  
 ④ Minimum

### Operating principle

The FFP control relay is used for motor protection. The variation in the power factor (current / voltage phase-shift or cosine  $\varphi$ ) is related to the variation in the mechanical load of the motor. The FFP control relay monitors the power factor, and therefore the mechanical load, and ensures that it stays between two defined, adjustable limits.

A green LED indicates presence of the power supply. Two yellow LEDs display the state of the output relays.

On power-up, both output relays are closed for the duration of the inhibit time (T2 adjustable between 0.5 and 20 seconds).

If the value of the power factor is between the two threshold values set, both relays are closed.

If the power factor exceeds the maximum threshold value set by the user, the high threshold relay de-energises after a delay T1 (adjustable between 0.3 and 3 seconds). During this delay, the green LED flashes (1 Hz). The relay closes again when the measured value drops below the threshold less the hysteresis.

If the power factor drops below the minimum threshold value set by the user, the low threshold relay de-energises after a delay (T1 adjustable between 0.3 and 3 seconds). During this delay, the green LED flashes. The relay closes again when the measured value is (1 Hz) above the threshold plus the hysteresis.

If the value of the high threshold is set as less than or equal to the low threshold value, the green LED flashes quickly (2 Hz).

# Motor control

## → FRL motor underspeed control

- Control of underspeed, stopping, running speed, or jamming of a motor.
- Data collected by three-wire or NAMUR sensor, or by contact or voltage
- Delay adjustable from 100 ms to 10 min in 4 sub-ranges.
- Delay on energisation adjustable from 0.3 to 30 sec.
- LEDs indicate power supply and state of output relay.



### Specifications

Type	Supply voltage	Code
FRL	24 VDC	84 874 300
	24 VAC	84 874 301
	110 VAC	84 874 303
	230 VAC	84 874 304

### General characteristics

#### Power supply characteristics

Supply voltage Un	24, 120, 230 VAC 50 / 60 Hz Galvanic isolation via transformer 24 V DC without galvanic isolation
Operating range	0.85 to 1.15 UN
Maximum power consumption - Version AC	3.5 VA max. at UN and 5 VA at Un +15 %
Maximum power consumption - Version DC	1 W max. at Un and 1.5 W at Un +15 %
Immunity from micro power cuts	10 ms
Insulation coordination	Category III, degree of pollution 2 conforming to IEC 664.1 / VDE 0110 : 4 KV/2

#### Control / input circuit characteristics

Input circuit 3-wire sensors	24 V PNP (50 mA max.)
Input circuit NAMUR sensor	8.2 V on 1 kΩ
Input circuit Contact	Volt-free
Input circuit Voltage input	30 V max.
Input resistance	16 kΩ except for NAMUR 1 kΩ
High state	Min. 4.5 V, max. 30 V
Low state	Min. 0 V, max. 1 V
Breaking frequency	200 Hz
Minimum pulse time	5 ms
Minimum time between pulses	5 ms
Selection of delay and memory function	8-position switch on front face
Selection of delay and memory function - No memory	0.1 to 1s, 1 to 10 s, 0.1 to 1 min, 1 to 10 min
Selection of delay and memory function - With memory	0.1 to 1s, 1 to 10 s, 0.1 to 1 min, 1 to 10 min
Hysteresis	5 % of treshold displayed
Display accuracy	10 % of full scale (@ 25°C)
Repetition accuracy	± 0.5 % with constant parameters
Drift Temperature	± 0.5 % / °C
Voltage-dependent drift	±1 % / V
Reset time	200 ms minimum
Reset time S2	100 ms minimum
Inhibit time delay	0.3 to 30 s ± 10 %

#### Output characteristics

Output	1 AgCdO changeover
Breaking capacity	2000 VA - 80 W
Maximum breaking current	8 A AC DC
Minimum breaking current	100 mA AC DC
Max. breaking voltage	100 V AC DC
Mechanical life (operations)	5 x 10 <sup>6</sup>
Electrical life	AC12 : 2000 VA - 10 <sup>5</sup> operations AC15 : Cos φ = 0.3 - 6000 operations DC13 : L/R = 300 ms - 6000 operations
Maximum rate	360 operations / hour at full load

#### General characteristics

Material housing	Self-extinguishing
Terminal capacity	2 x 1.5 mm <sup>2</sup> with ferrule 2 x 1.5 mm <sup>2</sup> without ferrule
Temperature limit operation (IEC 68.1.14) (°C)	-20 → +60
Temperature limits stored (IEC 68.1.1/2) (°C)	-30 → +70
Relative humidity (no condensation)	93 % (+2 % ; -3 %)
Weight (g)	255

To order, see page 6

## Dimensions

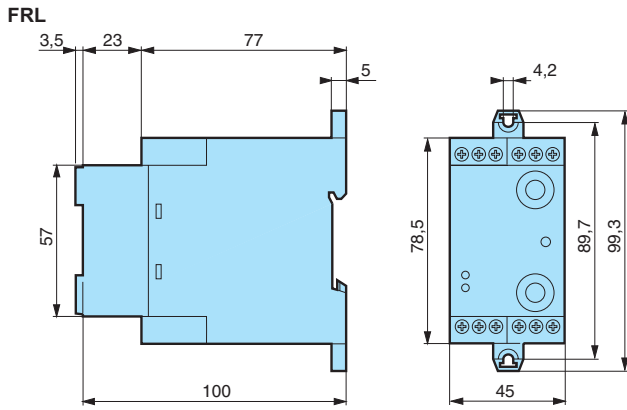

## Connection

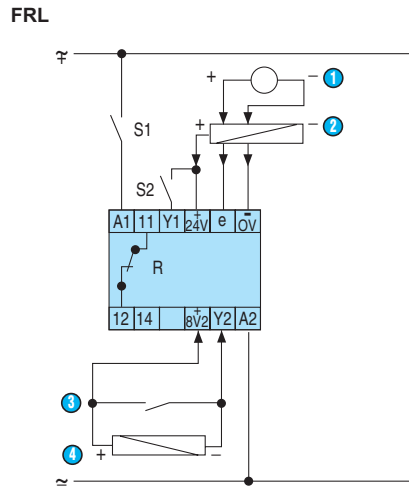

- ① Voltage
  - ② 3-wire PNP
  - ③ Volt-free contact
  - ④ Namur
- A1 - A2 : Supply voltage  
 11 - 12 - 14 : Output relay (R)  
 +24 V - E - 0 V : PNP three-wire sensor  
 E - 0 V : Voltage input  
 +8 V 2 - Y2 : Contact / NAMUR sensor input

## Principles

### Without latching

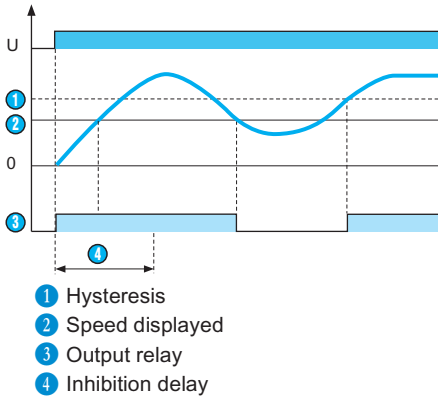

### Operating principle

The FRL control relay can be used to solve underspeed problems : conveyor belts, conveyors, etc where the crossing of a low speed threshold should trigger an alarm. Speed data is collected via a sensor such as a three-wire output proximity sensor, an NAMUR sensor or by volt-free contact or voltage.

On power-up, to allow the process which is being controlled to reach its operating speed, control is inhibited for a time of between 0.3 and 30 sec, which can be adjusted on the front face. If starting requires an inhibition time above 30 seconds, external contact S2 must be closed during starting to inhibit the FRL (during this time the yellow LED flashes), then opened when the nominal speed has been reached.

On each cycle of the process being controlled, the sensor sends a pulse to the FRL. Each of these pulses resets the internal time delay of the FRL. If the time between two pulses is less than the value set on the FRL, the delay is reset on each pulse and the output relay remains closed.

If the speed of the process decreases, the time between pulses increases. When the time between two pulses is greater than the value set on the FRL, the controlled process is in underspeed mode, the output relay of the FRL changes state (opens). The output relay closes again when the speed of the controlled process exceeds the preset value plus the hysteresis (5 % of the value displayed).

If "memory" mode is activated, the relay remains open when an underspeed fault is detected. In this case, the output relay can only close again after a manual reset has been performed by closing external contact S2.

A yellow LED indicates the state of the relay.  
 A green LED indicates the presence of the power supply.

### With latching

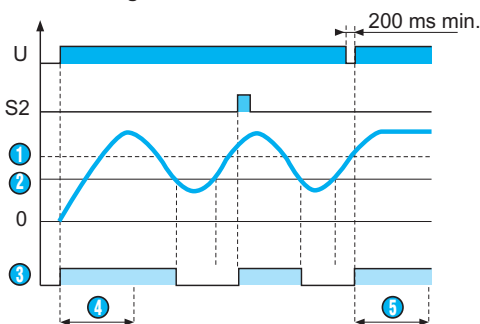

# Motor control

## → ETM / ETM2 / ETM22 motor thermal protection

- Controls temperature of machines using built-in PTC probes
  - Line break or probe short-circuit detection
- Version ETM2 / ETM22 :
- Fault latching function
  - Pushbutton for local reset
  - Remote reset via external contact
  - Pushbutton test facility
  - 2 LEDs to indicate relay and power supply status



### Specifications

Type	Output	Supply voltage	Code
ETM	1 N/O contact	24 V AC/DC	84 874 015
	1 N/O contact	120 V AC	84 874 013
	1 N/O contact	230 V AC	84 874 014
ETM2	1 changeover	24 V AC/DC	84 874 025
	1 changeover	120 V AC	84 874 023
	1 changeover	230 V AC	84 874 024
ETM22	2 changeovers	24 V AC	84 874 035
	2 changeovers	120 V AC	84 874 033
	2 changeovers	230 V AC	84 874 034

### General characteristics

#### Power supply characteristics

Supply voltage Un	230, 120 and 24 VAC 50 / 60 Hz Galvanic isolation by transformer 24 VDC no galvanic isolation
Operating range	0.85 to 1.10 Un
Nominal power	3 VA
Maximal power	5 VA
Immunity from micro power cuts	10 ms
Delay on pick-up	500 ms
Insulation coordination	Category III, degree of pollution 2 conforming to IEC 664.1 / VDE 0110 : 4 KV/2

#### Input circuit characteristics

Max. resistance of cold probes	1500 Ω
Trip threshold	3100 Ω ± 10 %
Reset threshold	1650 Ω ± 10 %
Short-circuit detection	0 - 10 Ω
Measurement voltage as per IEC 34-11	≤ 2.5 V
Repetition accuracy with constant parameters	± 0.05 % with constant parameters
Temperature drift	± 0.05 % / °C
Voltage-dependent drift	-2 %

#### Output characteristics

Output	AgNi 90/10
Breaking capacity	2000 VA - 80 W
Max. breaking current	8 A AC
Max. breaking voltage	440 V AC
Min. breaking current	100 mA AC DC
Maximum rate	360 operations / hour at full load
Mechanical life (operations)	5 x 10 <sup>6</sup>
Electrical life	AC12 : 2000 VA - 10 <sup>5</sup> operations AC15 : Cos φ = 0.3 - 6000 operations DC13 : L/R = 300 ms - 6000 operations

#### General characteristics

Reset time	≤ 500 ms
Response time	≤ 500 ms
Display on ETM2/ETM22 - power supply	green LED
Display on ETM2/ETM22 - Relay	yellow LED
Class of protection (529) - Term. block	IP 20
Class of protection (IEC 529) - Casing	IP 50
Material housing	Self-extinguishing
Weight (g)	145
Terminal capacity	2 x 1.5 mm <sup>2</sup> with ferrule 2 x 2.5 mm <sup>2</sup> without ferrule
Temperature limit operation (IEC 68.1.14) (°C)	-20 → +60 °C
Temperature limits stored (IEC 68.1.1/2) (°C)	-30 → +70 °C
Relative humidity (no condensation)	93 % (+2 % ; -3 %)

To order, see page 6

## Dimensions

### ETM / ETM2 / ETM22

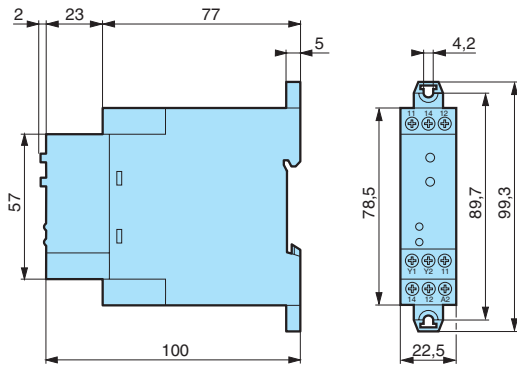

## Connections

### ETM

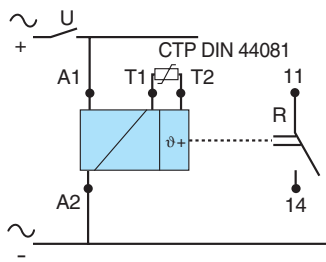

A1 - A2 : Supply voltage  
11 - 14 : Output relay  
T1 - T2 : External PTC probe

### ETM2

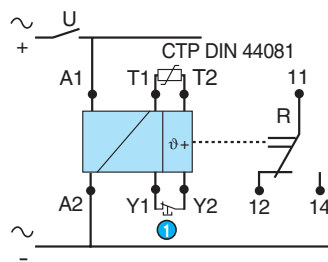

**1** Fault memory  
A1 - A2 : Supply voltage  
11 - 12 - 14 : Output relay  
T1 - T2 : External PTC probe  
Y1 - Y2 : Remote reset contact

### ETM22

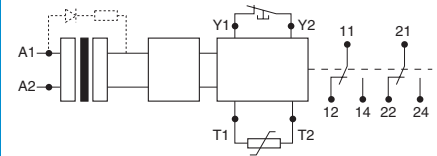

A1 - A2 : Supply voltage  
11 - 12 - 14 : Low threshold output relay (R1)  
21 - 22 - 24 : High threshold output relay (R2)  
T1 - T2 : External PTC probe  
Y1 - Y2 : Remote reset contact

### ETM

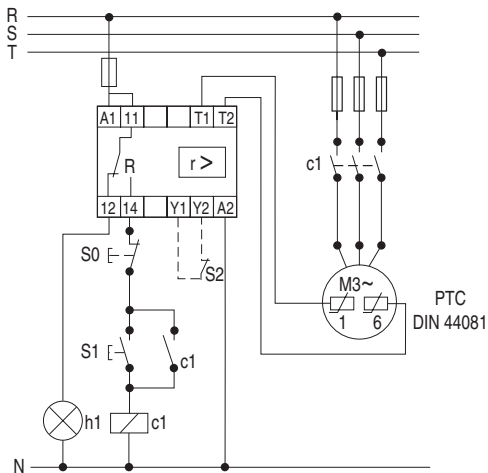

C1 : Contactor  
S1 : ON button  
S0 : OFF button  
S2 : Remote reset contact  
h1 : Fault indicator

## Principles

### Reset WITHOUT fault latching (Y1 and Y2 not connected for ETM2/ETM22)

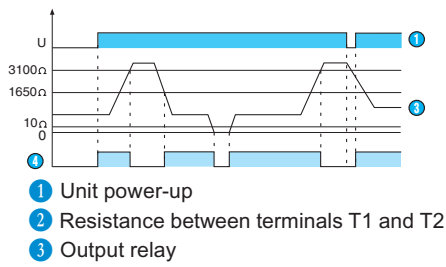

#### Operating principle

Control relay is used in combination with PTC thermistor probes (not supplied) for thermal protection of machines (motors, alternators, transformers, etc). The probes are placed at critical points on the equipment to be protected (normally inserted into the stator windings of motors). The resistance of the PTC probe has a positive temperature coefficient. As soon as the nominal trip temperature of the probe is exceeded, the resistance of the probe increases rapidly. Protection relay detects this and opens the power supply circuit of the protected equipment (eg motor) and the yellow fault indicator LED lights up (version ETM2/ETM22).

#### Test button

The ETM2/ETM22 has a TEST button which can be used to simulate a thermal overload in order to test the service condition of the relay.

#### Tripping

The relay drops out as soon as the protected equipment is subjected to a thermal overload, short-circuit or break in the probe measuring circuit.

#### Early warning of tripping

If the equipment being protected has another PTC probe with a lower nominal trip temperature, a second ETM/ETM2/ETM22 relay can be used to give early warning of tripping and thus prevent breaks in operation.

Control relay ETM/ETM2/ETM22 is automatically reset as soon as the temperature drops below the trip threshold (the yellow fault indicator LED goes out).

### PTC probe specification According to standard DIN 44081 (or IEC 34-11)

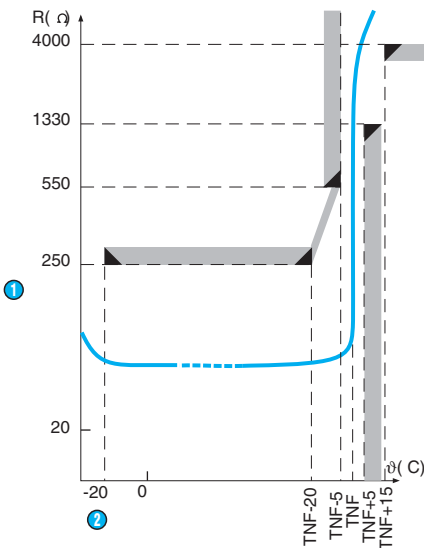

### Reset WITH fault latching (only for ETM2/ETM22) (Y1 and Y2 connected)

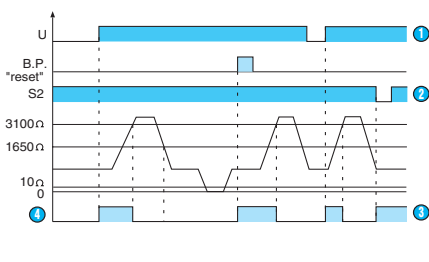

The relay is reset either using the RESET pushbutton on the front face or by opening the external contact S2 (remote reset), or by cutting the auxiliary power supply (terminals A1 - A2).

If the auxiliary power is cut for a period of time greater than the reset time (500 ms), the relay is reactivated if the probe detects a normal temperature when the power supply voltage is restored.



# Variable speed

## → Single-phase 300 W

- Control fan speeds in air-conditioning applications
- For 150 to 300 W asynchronous motor at 230 V AC with permanent dephasing via capacitor
- 0 / 10 V control input
- Quiet



### Specifications

Type	Designation	Code
VRT 300	VRT 300	84 886 019

### Dimensions

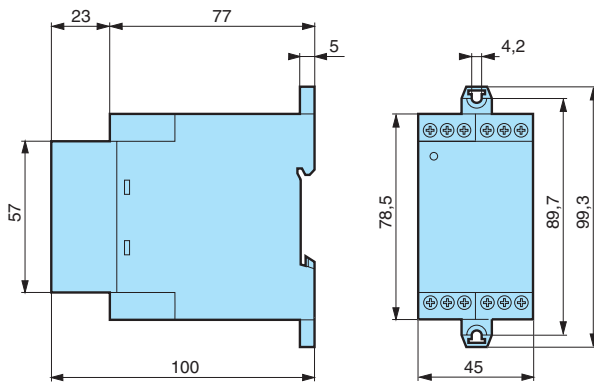

### Connections

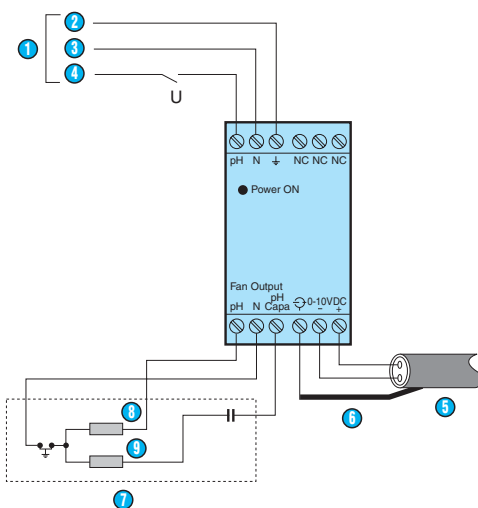

- 1 230 V AC mains input 50 Hz single-phase
- 2 Earth
- 3 Neutral
- 4 Phases
- 5 0 - 10 V DC control input cable (2-wire screened)
- 6 Screening
- 7 Single-phase asynchronous motor (230 V ; 50 Hz) with permanent dephasing via capacitor
- 8 Main phase
- 9 Auxiliary phase



## General characteristics

### Technical specifications

#### Supply

Voltage	230 V AC $\pm$ 15 %
Frequency	50 Hz $\pm$ 2 Hz
Power consumption	2.5 VA
Internal protection	Against voltage surges

#### 0 - 10 V input

Input voltage	0 $\rightarrow$ 10 V DC
Max. voltage	40 V DC
Input impedance (k $\Omega$ )	20 k $\Omega$
Protection	Against reversal of direction
Transfer characteristics	Linearized

#### Motor control

Characteristics of the load	
Supply	230 V AC $\pm$ 15 % ; 50 Hz $\pm$ 2 Hz
Absorbed power	150 $\rightarrow$ 300 W
cos $\phi$	0.95 $\rightarrow$ 0.99 at 230 V AC 0.9 to 80 V AC

#### Voltage range (RMS) at 230 V AC nominal

0 - 10 V control input	80 V $\rightarrow$ 225 V ( $\pm$ 15 V)
Relay breaking capacity	8 A / 250 V AC / AC 1

#### Display

LED on	Power supply present
LED off	Power supply missing

### Environmental characteristics

#### Climatic environment

##### Operation

Temperature ( $^{\circ}$ C)	+5 $\rightarrow$ +40
Relative humidity	85 % to 40 $^{\circ}$ C

##### Storage

Temperature ( $^{\circ}$ C)	-10 $\rightarrow$ +60
Humidity	< 70 %

### Mechanical environment

#### Resistance to vibrations

Amplitude	0.35 mm
Frequency range (Hz)	10 $\rightarrow$ 55
Number of axes	3
Cycle duration (min)	5
Number of cycles	20
Weight (g)	210
Dimensions	45 x 78 x 105 mm
Connection solid without ferrule	2 x 2.5 mm <sup>2</sup>
Connection stranded without ferrule	2 x 1.5 mm <sup>2</sup>
Mounting	DIN rail or panel mounted
Material housing	Self-extinguishing
Material terminal block	Self-extinguishing
Packaging	Individual Packed in lots of 5

### Electromagnetic environment

Product EMC standard	IEC 1800-3 (09/96)
Environment	Domestic and similar (residential, commercial and light industry)
Immunity to bursts of fast transients	Tested in accordance with IEC 1000-4-4 Power supply : 1 kV (direct) 0-10 V input : 0.5 kV (connection)
Immunity to electrostatic discharges	Tested in accordance with IEC 1000-4-2 Discharges on contact : 6 kV Discharges into the air : 8 kV
Immunity to impulse voltage	Tested in accordance with IEC 1000-4-5 Power supply : 1 kV (line-to-line connection) Power supply : 2 kV (connection btwn line & earth)
Immunity to radiated electromagnetic fields	Tested in accordance with IEC 1000-4-3 Frequency range 26 MHz to 1 GHz Level of severity : 3 V/m
Immunity to harmonic distortion	Tested in accordance with IEC 1000-2-2 (class 2) THD in steady state 8 %
Immunity to voltage fluctuations	Tested in accordance with IEC 1000-2-4 (class 2) Level $\pm$ 10 % Duration < 60 s
Immunity to frequency variations	Tested in accordance with IEC 1000-2-2 (class 2) Level $\pm$ 2 Hz
Conducted emissions	Tested in accordance with EN 55022 (94) / 11 group 1 Level of severity : Class B Frequency range : 0.15 to 30 MHz
Radiated emissions	Tested in accordance with EN 55022 (94) / 11 group 1 Level of severity : Class B Frequency range : 30 MHz to GHz
Dielectric withstand to impulses	Tested in accordance with IEC 664-1 Impulse : 1.2 / 50 $\mu$ s Level : 2.5 kV

## Principles

### Basic controller

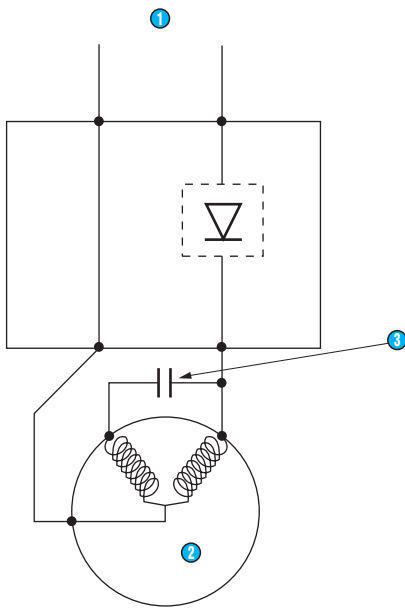

The current harmonics circulate in both motor phases and generate constant noise.

- 1 230 V AC mains
- 2 Motor
- 3 Dephasing capacitors

### Crouzet controller

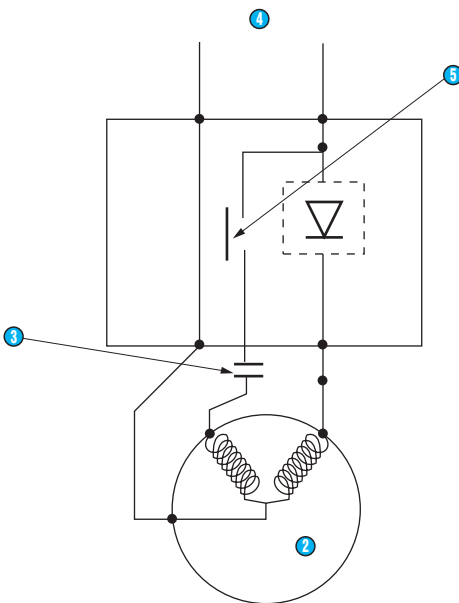

The current harmonics circulate in a single phase and generate very little noise.

- 2 Motor
- 3 Dephasing capacitors
- 4 230 V AC mains
- 5 Auxiliary phase power-up contact

## Curves

### Operating principle

Phase control by modification of the aperture angle of a triac.

#### 0 - 10 V input :

Motor control activated when input higher than  $2 \text{ V} \pm 150 \text{ mV}$ .

#### Comment :

When the motor starts, control is forced to full speed for 2 seconds.

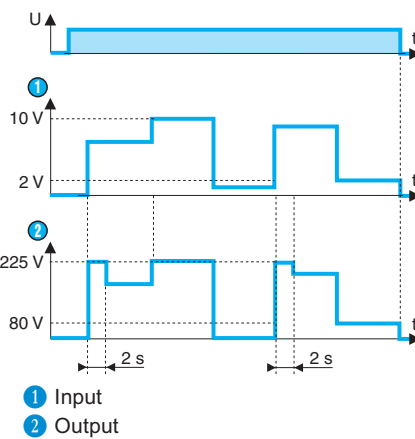

### Transfer function

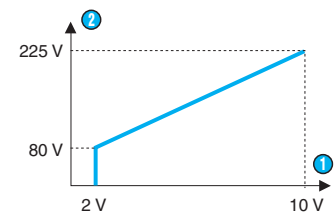

- 1 Input
- 2 Output

# Solid state relays

Solid state relays



## → Solid state relays - resistive and inductive load

Mains supply	Current*	Output voltage	Control voltage	Designation	Resistive load	Inductive load		
Single-phase	3 A	5 to 48 V DC	4 to 32 V DC	GMS	Page 179			
	5 A	12 to 280 V AC	4 to 32 V DC	GMS	Page 179	Page 179		
	10 A	1 to 200 V DC	24 to 280 V AC	3 to 32 V DC	GN	Page 176	Page 176	
				4 to 32 V DC				
		18 to 36 V AC / DC						
		90 to 280 V AC / DC						
	48 to 660 V AC	18 to 36 V AC / DC	90 to 280 V AC / DC	4 to 32 V DC				
				18 to 36 V AC / DC				
	12 A	24 to 280 V AC	24 to 280 V AC	4 to 32 V DC	GRD Integrated heatsink	Page 162		
				180 to 280 V AC / DC				
	15 A	1 to 100 V DC	24 to 280 V AC	90 to 140 V AC	GN	Page 170		
				3 to 32 V DC				
	25 A	24 to 280 V AC	48 to 660 V AC	4 to 32 V DC	GRD Integrated heatsink	Page 162	Page 162	
				180 to 280 V AC / DC				
				90 to 140 V AC				
				4 to 32 V DC				
		24 to 280 V AC	18 to 36 V AC / DC	90 to 280 V AC / DC	4 to 32 V DC	GN	Page 176	Page 176
					18 to 36 V AC / DC			
					90 to 280 V AC / DC			
					4 to 32 V DC			
	48 to 660 V AC	18 to 36 V AC / DC	90 to 280 V AC / DC	4 to 32 V DC				
				18 to 36 V AC / DC				
				90 to 280 V AC / DC				
				4 to 32 V DC				
	30 A	1 to 50 V DC	24 to 280 V AC	3 to 32 V DC	GN	Page 170		
				4 to 32 V DC				
	35 A	48 to 660 V AC	24 to 280 V AC	4 to 32 V DC	GRD Integrated heatsink	Page 164	Page 164	
				90 to 280 V DC				
45 A	48 to 660 V AC	24 to 280 V AC	4 to 32 V DC	GRD Integrated heatsink	Page 164	Page 164		
			90 to 280 V AC					
50 A	24 to 280 V AC	48 to 660 V AC	4 to 32 V DC	GN	Page 176	Page 176		
			18 to 36 V AC / DC					
	90 to 280 V AC / DC							
	4 to 32 V DC							
75 A	24 to 280 V AC	48 to 660 V AC	18 to 36 V AC / DC	GN	Page 176	Page 176		
			90 to 280 V AC / DC					
	4 to 32 V DC							
	18 to 36 V AC / DC							
100 A	24 to 280 V AC	48 to 660 V AC	90 to 280 V AC / DC	GN	Page 176	Page 176		
			4 to 32 V DC					
	18 to 36 V AC / DC							
	90 to 280 V AC / DC							
125 A	24 to 280 V AC	48 to 660 V AC	4 to 32 V DC	GN	Page 176	Page 176		
			18 to 36 V AC / DC					
	90 to 280 V AC / DC							
	4 to 32 V DC							
48 to 660 V AC	18 to 36 V AC / DC	90 to 280 V AC / DC	18 to 36 V AC / DC					
			90 to 280 V AC / DC					

GMS

GRD 22.5 mm

GRD 45 mm

GRD 90 mm



GN with cover

GN without cover

\*The current ratings should be checked against the thermal curves (see catalogue) in order to select the appropriate heatsink  
 For a GN relay with cover 84 137 102  
 For a GN relay without cover 84 134 102

5

THYRISTOR

	Mains supply	Current*	Output voltage	Control voltage	Designation	Resistive load	Inductive load	
THYRISTOR	Two-phase	2 x 35 A	48 to 660 V AC	4 to 32 V DC	GRD	Page 168	Page 168	
				90 to 280 V AC / DC				
		25 A	24 to 280 V AC	4 to 15 V DC	DUAL	Page 174	Page 174	
				17 to 32 V DC				
		40 A	24 to 280 V AC	4 to 15 V DC	DUAL	Page 174	Page 174	
				17 to 32 V DC				
	Three-phase	3 x 25 A	48 to 660 V AC	4 to 32 V DC	GRD	Page 166	Page 166	
				90 to 280 V AC / DC				
		3 x 10 A	24 to 660 V AC	4 to 32 V DC	GA3	Page 190	Page 190	
				90 to 280 V AC				
3 x 25 A		24 to 660 V AC	4 to 32 V DC	GA3	Page 190	Page 190		
			90 to 280 V AC					
3 x 45 A	24 to 660 V AC	4 to 32 V DC	GA3	Page 190	Page 190			
		90 to 280 V AC						
Three-phase changeover	3 x 25 A	24 to 280 V AC	3 to 32 V DC	GA0		Page 188		
TRIAC	Single-phase	10 A	24 to 280 V AC	3 to 32 V DC	GNA5	Page 172		
				18 to 36 V AC / DC				
				90 to 280 V AC / DC				
		25 A	24 to 280 V AC	3 to 32 V DC	GNA5	Page 172		
				18 to 36 V AC / DC				
				90 to 280 V AC / DC				

\*The current ratings should be checked against the thermal curves (see catalogue) in order to select the appropriate heatsink  
 For a GN relay with cover **87 137 102**  
 For a GN relay without cover **87 134 102**

## → Solid state relays – GA1 and GA8 range

	Mains supply	Current*	Output voltage	Control voltage	Designation	Resistive load	Inductive load	
TRIAC	Single-phase	3 A	24 to 280 V AC	3 to 32 V DC	GA8	Page 182	Page 182	
		4 A	24 to 280 V AC	3 to 32 V DC	GA1	Page 182		
					GA8			
		5 A	24 to 280 V AC	3 to 32 V DC	GA8	Page 182	Page 182	

\*The current ratings should be checked against the thermal curves (see catalogue) in order to select the appropriate heatsink to connect

## → Solid state relays - GZ

	Mains supply	Current*	Output voltage	Control voltage	Designation	RC Circuit	Resistive load	Inductive load	
TRIAC	Single-phase	12 A	24 to 280 V AC	4 to 15 V DC	GZ	No	Page 186	Page 186	
						Yes			
			36 to 530 V AC			No			
						Yes			
		20 A	24 to 280 V AC	4 to 15 V DC	GZ	No	Page 186	Page 186	
						Yes			
			36 to 530 V AC			No			
						Yes			

\*The current ratings should be checked against the thermal curves (see catalogue) in order to select the appropriate heatsink to connect

→ Relay-heat-sink assembly for DIN rail mounting

Mains supply	Designation	Resistive load	Inductive load	Designation	Resistive load	Inductive load
Single-phase	GA0 25 A		x	GA3 25 A	x	Page 180
	GA0 45 A	x		GA3 10 A		

→ Solid state relays - RHP

Function	Current	Output voltage	Control voltage	Designation	
AC control contactor	20 A single-pole	90 to 260 V AC	90 to 260 V AC	RHP	Page 160
DC control contactor	20 A single-pole	90 to 260 V AC	4 to 32 V DC	RHP	Page 160
Day/night contactor	20 A single-pole	90 to 260 V AC	90 to 260 V AC	RHP	Page 160
Impulse relay	20 A single-pole	90 to 260 V AC	90 to 260 V AC	RHP	Page 160



RHP

→ SMART MODULE - Control module for “Hockey puck” type solid state relays

Function	Current	Output voltage	Control voltage	Désignation	
<ul style="list-style-type: none"> <li>Provides both visual and electrical information if a fault occurs in the circuit or on the solid state relay being controlled.</li> <li>For mounting on single-phase "hockey puck" type solid state relays.</li> </ul>	15 to 35 A	4 to 32 V DC	5 to 24 V DC	SMART MODULE	Page 184





# Hybrid power relays

## → RHP

- 20 A in a case only 17.5 mm wide
- Service life > 5 million operations at full load
- Silent operation
- Functions : contactor - impulse relay - day / night contactor
- Clips onto a 35 mm DIN rail
- UL/UL (listed) approval
- NF-USE label
- "CE" / Low Voltage Directive conformity



## Specifications

Type	Input voltage	Frequency	Thresholds OFF control	Thresholds ON control	Code
Day/night contactor	90 → 260 V AC	50 / 60 Hz	0 → 46 V AC	76 → 260 V AC	84 138 201
Impulse relay	90 → 260 V AC	50 / 60 Hz	0 → 46 V AC	76 → 260 V AC	84 138 101
Contactor	90 → 260 V AC	50 / 60 Hz	0 → 46 V AC	76 → 260 V AC	84 138 001
	4 → 32 V DC	50 / 60 Hz	0 → 1 V DC	4 → 32 V DC	84 138 000
	18 → 36 V AC	50 / 60 Hz	0 → 1 V AC	18 → 36 V AC	84 138 002

## General characteristics

### Input characteristics

Minimum duration of the control 50 ms

### Output characteristics

Max. current	20 A (AC1 / AC51 / AC7a)
Overload current 20 A (IEC 60947-4-3)	AC-51 : 1.25 x I <sub>e</sub> - 60 s : 50-30
Minimum current	100 mA (AC1 / AC51 / AC7a)
Frequency	50 / 60 Hz
Contact	N.O
Number of operations	> 5 000 000
Leakage current	< 5 mA
Acoustic noise in steady state	< 35 dB at 1 m
Acoustic noise on switching	< 50 dB at 0.5 m
Tightening capacity of terminals	2 x 1.5 mm up2 ; with ferrule 2 x 2.5 mm up2 ; without ferrule 1 x 4 mm up2 ; without ferrule
Tightening torque	1 Nm max. M3 screw (IEC60947-1)
Operating temperature (°C)	-5 → +55
Storage temperature (°C)	-40 → +85
Relative humidity (no condensation)	90 → 95 %
Material housing	Self-extinguishing
Protection (IEC 529) Housing	IP20
Protection (IEC 529) Terminal	IP50
Weight (g)	70

## Dimensions

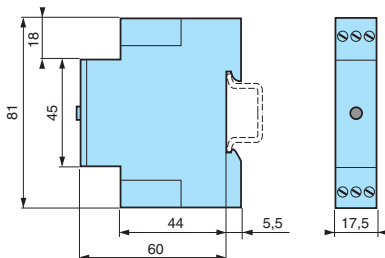



## Connections

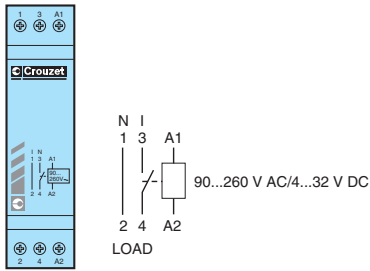

## Principles

### Operating principles

#### Contactor

The contactor output is closed when the control voltage is present at the control input terminals.  
The contactor output is open when there is no voltage at the control input terminals.  
The LED is lit when the output is active.

#### Impulse relay

The impulse relay output changes state on each impulse at the control input terminals, and remains in that state between each impulse. The output changes state on the rising edge of the control state change.

The pushbutton on the front can be used to select an operating mode : Automatic (LED lit) : Impulse relay function (Auto)

Forced operation (LED flashing) : output closed (ON)

Stop (LED not lit) : output open (OFF)

#### Day/night contactor

The contactor output is closed when the control voltage is present at the control input terminals. The contactor output is open when there is no voltage at the control input terminals.

The pushbutton on the front can be used to select an operating mode : Automatic (LED lit) : Day/night contactor function (Auto)

Forced operation (LED flashing) : output closed (ON)

When the control changes state, the day/night contactor reverts to automatic mode.

Stop (LED not lit) : output open (OFF)

#### Conformity with standards

IEC/EN 60947-4-3 (industrial environment)

IEC/EN 60669-2-1 (domestic environment)

IEC/EN 60601-1 (medical environment)

IEC/EN 60947-7-1 (connection for industrial env.)

IEC/EN 60998-2-1 (connection for domestic env.)

#### Insulation coordination:

Installation category: 3

Degree of pollution: 3

According to IEC/EN60669-2-1:

Breakdown voltage according to IEC/EN60669-2-1:

2 KV/1Min / 1mA / 50 Hz

Insulation resistance according to IEC/EN60669-2-1:

> 5M $\Omega$  /500VDC / 1Min

Vibrations according to IEC/EN60068-2-6: frequencies: 10 to 55Hz

amplitude: 0.35 mm

# GRD single or double phase DIN rail mounting

## → GRD range 22.5 mm single phase

- Single phase
- Complete, compact units
- Tailor-made solution to current sinks
- DIN rail and panel mounting
- Rating : 12 and 25 A (Triac) -25 A (SCR)
- Protection by RC filter
- Optional protection by removable varistor
- LED display of input status
- UL-Cul approval and CE marking



### Specifications

Type	Current	Output voltage	Input voltage	Code
Zero voltage switching (Triac)	12 A	24 - 280 V AC	90 - 140 V AC	84 130 150
			4 - 32 V DC	84 130 101
			180 - 280 V AC/ DC	84 130 100
	20 A	24 - 280 V AC	90 - 140 V AC	84 130 152
			4 - 32 V DC	84 130 103
			180 - 280 V AC/ DC	84 130 102
Zero voltage switching (SCR)	25 A	48 - 660 V AC	180 - 280 V AC DC	84 130 118
			4 - 32 V DC	84 130 116
			90 - 140 V AC	84 130 158
Instantaneous switching (SCR)	25 A	48 - 660 V AC	4 - 32 V DC	84 130 117

### Connections

#### GRD range - single-phase with triac

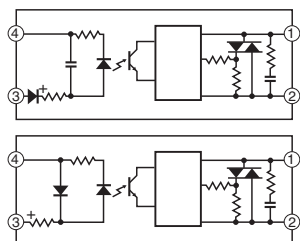

#### GRD range - single-phase with SCR Zero voltage switching

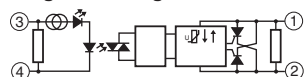

#### GRD range - single-phase with SCR Instantaneous switching

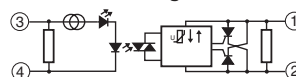

### Curves

#### GRD range 22.5 mm - 12 A (Triac)

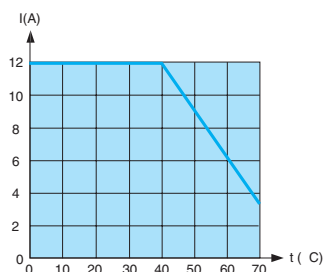

#### GRD range 22.5 mm - 25 A (Triac)

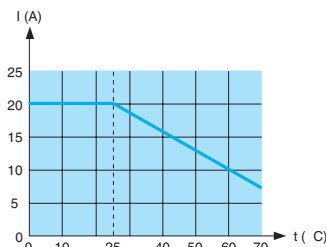

#### 25 A (SCR)

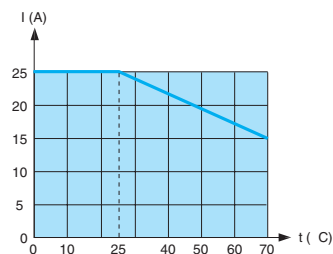

## General characteristics

### Output characteristics

Voltage range (Vrms max)	Triac : 24-280 Thyristor : 48-660
Peak voltage - t = min (V)	Triac : 600 Thyristor : 1200
Maximum off-state leakage at Vmax and T = 25 °C (mAeff per phase)	Triac : 15 Thyristor : 20
Minimum current mA(rms) per phase	Triac : 50 Thyristor : 100
Max. 1-cycle surge A(peak)	Triac : 100-250 Thyristor : 750
Max. 1-second surge A(peak)	Triac : 30-75 Thyristor : 145
On-state voltage drop at I max V(peak)	Triac : 1.6 Thyristor : 1.6
I t (t = 10 ms) (A²s)	Triac : 312-750 Thyristor : 1250
Static (off-state) dv/dt (V/µs)	Triac : 200 Thyristor : 500
Supply frequency range	Triac : 47 → 80 Hz Thyristor : 47 → 80 Hz
Cos φ (Zero voltage)	Triac : > 0.5 Thyristor : > 0.5
Rth junction / ambient air (°C/W)	Triac : 4.9 - 3.6 Thyristor : 2.5

### Inputs specifications

Input voltage	Triac : 90-280 AC/DC Thyristor : 4-32 DC
Turn-off voltage (V)	Triac : 10 Veff Thyristor : 1 VDC
Maximum current at Vmax	Triac : 5.5 mAeff Thyristor : 12 mA
Nominal input resistance (kΩ)	Triac : 45 Thyristor : 3
Response time (close) (ms)	Triac : 20 ms Thyristor : 0.5 cycle max.
Response time (open) (ms)	Triac : 30 ms Thyristor : 0.5 cycle max.

### General characteristics

Operating temperature (°C)	-20 → +80
Storage temperature (°C)	-40 → +100
Input to output insulation voltage V(rms)	4 000
Dielectric strength V(rms)	2 500
Input/output capacitance (pF)	8
Material housing	Self-extinguishing (UL 94 V0)
Material baseplate	Aluminium
Weight (g)	250
Terminal capacity	Ø 2 mm max.

## Dimensions

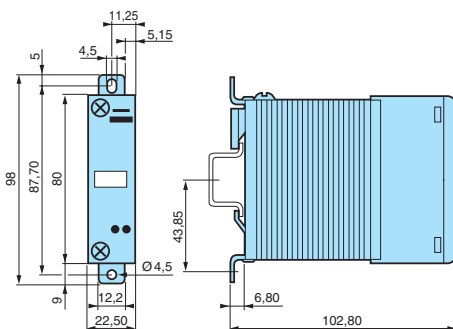

# GRD single or double phase DIN rail mounting

## → GRD Range 45 mm single phase

- Single phase
- Complete, compact units
- Tailor-made solution to current sinks
- DIN rail and panel mounting
- Rating : 35 and 45 A
- Back-to-back SCRs
- Protection by RC filter
- Optional protection by removable varistor
- LED display of input status
- UL-Cul approval and CE marking



### Specifications

Type	Current	Output voltage	Input voltage	Code
Zero voltage switching SCR output	35 A	48 - 660 V AC	90 - 280 V AC / DC	84 130 110
			4 - 32 V DC	84 130 111
	45 A	48 - 660 V AC	90 - 280 V AC / DC	84 130 115
			4 - 32 V DC	84 130 113
Instantaneous switching Thyristor output	35 A	48 - 660 V AC	4 - 32 V DC	84 130 112
	45 A			84 130 114

### General characteristics

#### Output characteristics

Voltage range (Vrms max)	48-660
Peak voltage - t = min (V)	1000 <sup>(1)</sup>
Maximum off-state leakage at Vmax and T = 25 °C (mAeff per phase)	4
Minimum current mA(rms)	100
Max. 1-cycle surge A(peak)	750
Max. 1-second surge A(peak)	145
On-state voltage drop at Imax and T = 25 °C V(peak)	1.6
I t (t = 10 ms) (A <sup>2</sup> s)	35A : 1260
	45A : 5000
Static (off-state) dv/dt (V/μs)	500
Supply frequency range	47 → 80
Cos φ (Zero voltage)	> 0.5
Rth junction / ambient air (°C/W)	35A : 3.78 °C
	45A : 1.65 °C/W

#### Inputs specifications

Input voltage	35A : 80-280 AC/DC
	45A : 4-32 DC
Turn-off voltage (V)	35A : 10 Veff
	45A : 1 V DC
Maximum current at Vmax	35A : 10 mAeff
	45A : 12 mA
Nominal input resistance (kΩ)	35A : 45
	45A : 3
Response time (close) (ms)	35A : 20 ms
	45A : 0.5 cycle max.
Response time (open) (ms)	35A : 30 ms
	45A : 0.5 cycle max.

#### General characteristics

Operating temperature	-20 → +80 °C
Temperature stored	-40 → +100 °C
Input to output insulation voltage V(rms)	4000
Dielectric strength V(rms)	2500
Input/output capacitance (pF)	8
Material housing	Self-extinguishing (UL 94 V0)
Material baseplate	aluminium
Weight (g)	490
Input terminal capacity	Ø 2 mm max.
Output terminal capacity	Ø 5.6 mm max.

## Dimensions

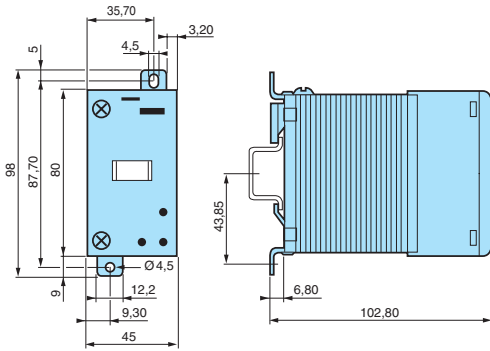

## Connections

GRD range - single-phase with SCR  
Zero voltage switching

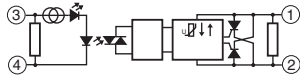

GRD range - single-phase with SCR  
Instantaneous switching

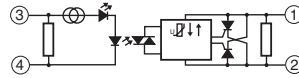

GRD range - single-phase with SCR  
Instantaneous switching

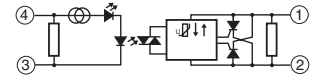

## Curves

GRD range 45 mm - 35 A

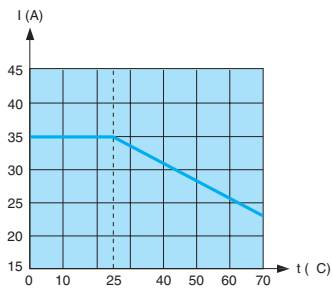

GRD range 45 mm - 45 A

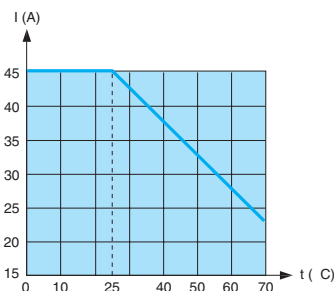

# GRD three-phase DIN rail mounting

## → GRD Range 90 mm 3 phase

- Three-phase
- Complete, compact units
- Tailor-made solution to current sinks
- DIN rail and panel mounting
- Rating : 3 x 25 A
- Back-to-back SCRs
- Protection by RC filter
- Optional protection by removable varistor
- LED display of input status
- UL-Cul approval and CE marking



### Specifications

Type	Current	Output voltage	Input voltage	Code
SCR zero voltage switching	3 x 20 A	48 - 660 V AC	90 - 280 V AC / DC	84 130 311
			4 - 32 V DC	84 130 310
SCR Instantaneous switching	3 x 20 A	48 - 660 V AC	4 - 32 V DC	84 130 312

### General characteristics

#### Output characteristics

Voltage range (Vrms max)	48-660
Peak voltage (1 min) V(peak)	1200
Maximum current	3x35 (A)
Maximum off-state leakage at Vmax and T = 25 °C (mAeff per phase)	20
Minimum current (mArms per phase)	100
Max 1 cycle surge T = 25 °C A(rms)	500
Max 1 second surge T = 25 °C A(rms)	145
On-state voltage drop at Imax and T = 25 °C V(peak)	1.6
I t (t = 10 ms) (A <sup>2</sup> s)	1260
Static (off-state) dv/dt (V/μs)	500
Supply frequency range	47 → 80 Hz
Cos φ (Zero voltage)	> 0.5
Rth junction / ambient air (°C/W)	1 °C/W

#### Inputs specifications

Input voltage	90-280 AC/DC 4-32 DC
Turn-off voltage (V)	10 Veff 1 V DC
Maximum current at Vmax	10 mAeff 10 mA
Nominal input resistance (kΩ)	45 3
Response time (close) (ms)	20 ms 0.5 cycle max.
Response time (open) (ms)	30 ms 0.5 cycle max.

#### General characteristics

Operating temperature (°C)	-20 → +80
Storage temperature (°C)	-40 → +100
Input to output insulation voltage V(rms)	4000
Dielectric strength V(rms)	2500
Material housing	Self-extinguishing (UL 94 V0)
Material baseplate	aluminium
Input/output capacitance (pF)	8
Weight (g)	940

## Dimensions

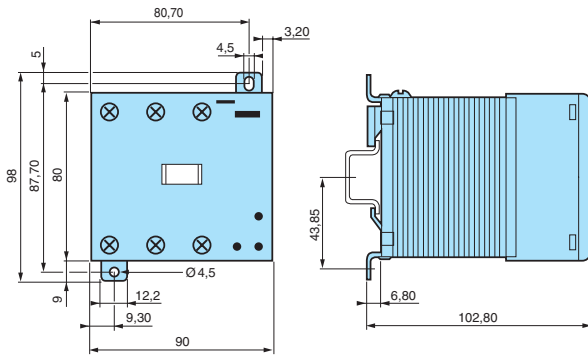

## Connections

### GRD range - three-phase with SCR

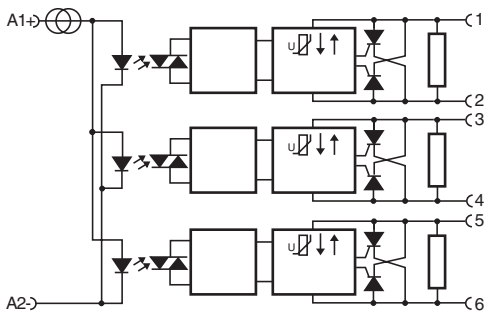

## Curves

### GRD range 90 mm - 3 x 20 A

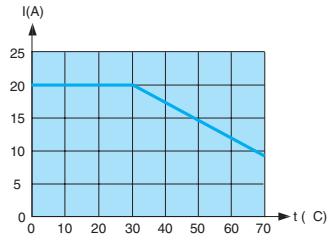

# GRD double phase DIN rail mounting

## → GRD Range 90 mm double phase

- Double phase
- Complete, compact units
- Tailor-made solution to current sinks
- DIN rail and panel mounting
- Rating : 2 x 25 A
- Back-to-back SCRs
- Protection by RC filter
- Optional protection by removable varistor
- LED display of input status
- UL-Cul approval and CE marking



### Specifications

Type	Current	Output voltage	Input voltage	Code
SCR zero voltage switching	2 x 25 A	48 - 660 V AC	90 - 280 V AC / DC	84 130 222
			4 - 32 V DC	84 130 220
SCR Instantaneous switching	2 x 25 A	48 - 660 V AC	4 - 32 V DC	84 130 221

### General characteristics

#### Output specifications

Voltage range (Vrms max)	48-660
Peak voltage (1 min) V(peak)	1200
Maximum current	2500
Maximum off-state leakage at Vmax and T = 25 °C (mAeff per phase)	2x25A
Minimum current (mArms per phase)	100
Max 1 cycle surge T = 25 °C A(rms)	500
Max 1 second surge T = 25 °C A(rms)	135
On-state voltage drop at Imax and T = 25 °C V(peak)	1.6
I t (t = 10 ms) (A <sup>2</sup> s)	1260
Supply frequency range	47 → 80 Hz
Cos φ (Zero voltage)	> 0.5
Rth junction / ambient air (°C/W)	0.95

#### Inputs specifications

Input voltage	90-280 AC/DC 4-32 DC
Turn-off voltage (V)	10 Veff 1 V DC
Maximum current at Vmax	10 mAeff 10 mA
Nominal input resistance (kΩ)	45 3
Response time (close) (ms)	20 ms 0.5 cycle max.
Response time (open) (ms)	30 ms 0.5 cycle max.

#### General characteristics

Operating temperature (°C)	-20 → +80
Storage temperature (°C)	-40 → +100
Input to output insulation voltage V(rms)	4000
Dielectric strength V(rms)	2500
Input/output capacitance (pF)	8
Material housing	Self-extinguishing (UL 94 V0)
Material baseplate	aluminium
Weight (g)	940



## Dimensions

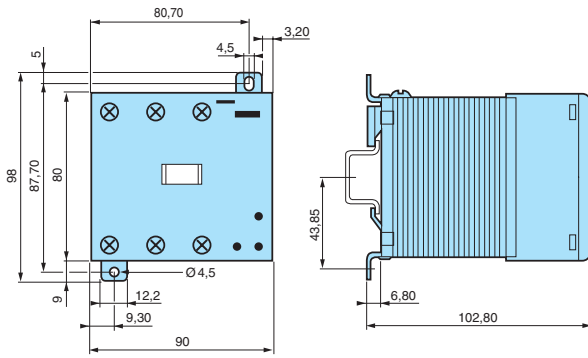

## Curves

GRD range 90 mm - 2 x 25 A

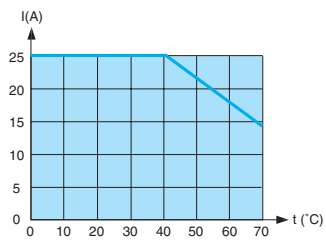

# GN single-phase

## → GND DC output

- FET transistor versions 10, 15 and 30 A
- Bipolar transistor version 10 A
- Control voltage : 3 to 32 V
- Optimum thermal response
- Available with or without protective cover
- UL/Cul, TUV approval and CE marking



### Specifications

Type	Current	Output voltage	Input voltage	Protective cover	Code
FET version	10 A	1 - 200 V DC	3 - 32 V DC	with protective cover	84 137 850
	15 A	1 - 100 V DC	3 - 32 V DC	with protective cover	84 137 860
	30 A	1 - 50 V DC	3 - 32 V DC	with protective cover	84 137 870
	10 A	1 - 200 V DC	3 - 32 V DC	without protective cover	84 134 850
	15 A	1 - 100 V DC	3 - 32 V DC	without protective cover	84 134 860
	30 A	1 - 50 V DC	3 - 32 V DC	without protective cover	84 134 870
Bipolar version	10 A	3 - 60 V DC	3 - 32 V DC	with protective cover	84 137 750
	10 A	3 - 60 V DC	3 - 32 V DC	without protective cover	84 134 750

### General characteristics

#### Output characteristics

Voltage range (Vrms max)	FET 10A : 1 - 200 FET 15A : 1 - 100 FET 30A : 1 - 50 Bipolar 10A : 3 - 60
Minimum current mA(rms)	FET 10A : 14 FET 15A : 1 FET 30A : 1 Bipolar 10A : 10
Max. non-rep. 10 $\mu$ (T=25°C) (A)	FET 10A : 90 FET 15A : 120 FET 30A : 160
Max. non-rep. 1 s surge (T=25°C) (A)	10A : 90
Thermal resistance Junction to casing (°C/W)	FET 10A : 2.25 FET 15A : 2.25 FET 30A : 2.45 Bipolar 10A : 3.75

#### Inputs specifications

Turn-off voltage (V)	1
Max. controlled current (mA)	FET : 20 Bipolar : 14.5
Response time (close) (ms)	FET : 2 Bipolar : 100
Response time on closing (ms)	FET : 100 Bipolar : 200

#### General characteristics

Operating temperature (°C)	-20 → +80
Storage temperature (°C)	-55 → +125 -40 → +100
Input to output insulation voltage V(rms)	4000
Dielectric strength V(rms)	2500
Input/output capacitance (pF)	8
Material housing	UL 94 V
Material baseplate	zamak
Weight	With cover : 114 g Without cover : 97 g

## Dimensions

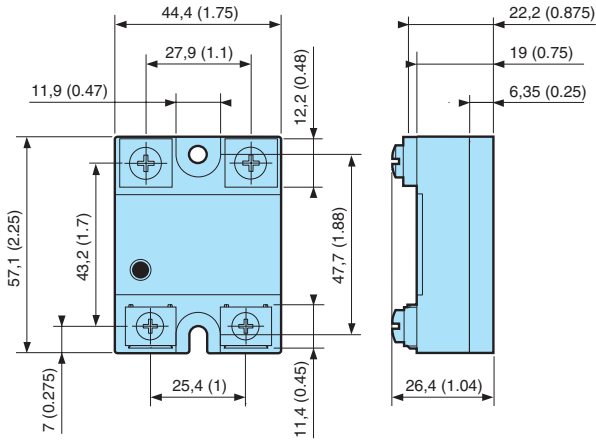

## Curves

GN SSR FET 10 A

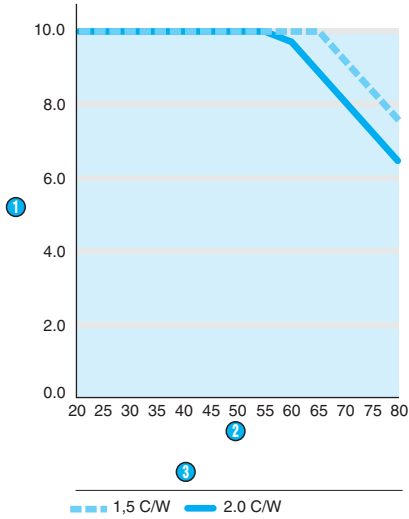

GN SSR FET 15 A

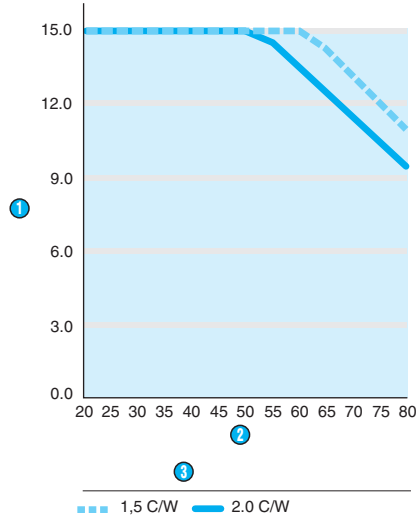

GN SSR FET 30 A

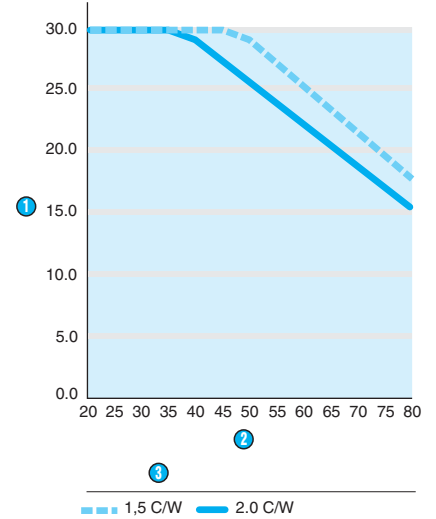

GN SSR BIPOLAR 10 A

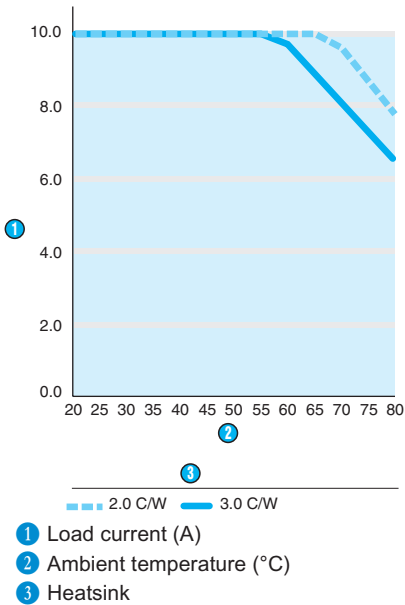

# GN single-phase

## → GNA5 - Triac output

- Intended for resistive loads
- Current ratings 10 and 25 A
- Output voltage 24 to 280 V AC
- "Zero voltage" switching
- Optimum thermal response
- Control input 3-32 V DC, 18 to 36 V AC, 90 to 280 V AC
- Connection via screws or faston connectors
- UL / Cul, TUV approval and CE marking



### Specifications

Type	Current	Output voltage	Input voltage	Code
Screw	10 A	24-280 V AC	3-32 V DC	84 134 900
			18-36 V AC/DC	84 134 902
			90-280 V AC/DC	84 134 901
	25 A	24-280 V AC	3-32 V DC	84 134 910
			18-36 V AC/DC	84 134 912
			90-280 V AC/DC	84 134 911
Fast on	10 A	24-280 V AC	3-32 V DC	84 134 907
			18-36 V AC/DC	84 134 908
			90-280 V AC/DC	84 134 909
	25 A	24-280 V AC	3-32 V DC	84 134 917
			18-36 V AC/DC	84 134 918
			90-280 V AC/DC	84 134 919

### General characteristics

#### Output characteristics

Range	24-280 V AC
Non-rep. peak voltage (Vp)	500
Maximum off-state leakage at Vmax and T = 25 °C (mAeff per phase)	4.75
Minimum current (mA)	100
Max. non-rep.1-cycle surge (T=25 °C) (A)	30 (10 A) 75 (25 A)
Max. non-rep. 1 s surge (T=25 °C) (A)	100 (10 A) 250 (25 A)
I <sup>2</sup> t (50-60 Hz) (A <sup>2</sup> s)	50 - 41 (10 A) 288 - 240 (25 A)
Voltage drop at Imax (T=25°C) (V)	1.65 (10 A) 1.85 (25 A)
Static dv/dt (V/μs)	200
Thermal resistance Junction to casing (°C/W)	3 (10 A) 2 (25 A)

#### Inputs specifications

Range	3-32 V DC 18-36 V AC/DC 90-280 V AC/DC
Turn-off voltage (V)	3-32 V DC : 1 18-36 V AC/DC : 2 90-280 V AC/DC : 10
Max. current (mA)	3-32 V DC : 14 18-36 V AC/DC : 8 90-280 V AC/DC : 8.5
Response time (close) (ms)	3-32 V DC : 8.33 (60Hz) 10 (50Hz) 8-36 V AC/DC : 20 90-280 V AC/DC : 20
Response time on closing (ms)	3-32 V DC : 8.33 (60Hz) 10 (50 Hz) 18-36 V AC/DC : 30 90-280 V AC/DC : 30

#### General characteristics

Operating temperature (°C)	-20 → +80
Storage temperature (°C)	-40 → +100
Input to output insulation voltage V(rms)	4000
Dielectric strength V(rms)	2500
Input/output capacitance (pF)	8
Frequency (Hz)	47 → 63
Material housing	UL 94 V
Material baseplate	zamak
Weight (g)	97

To order, see page 6

## Dimensions

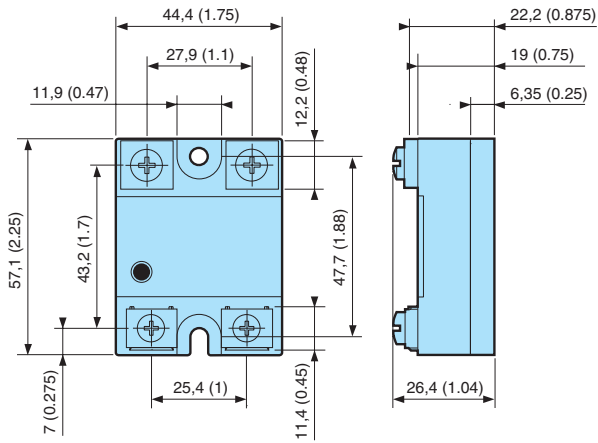

## Curves

10 A

25 A

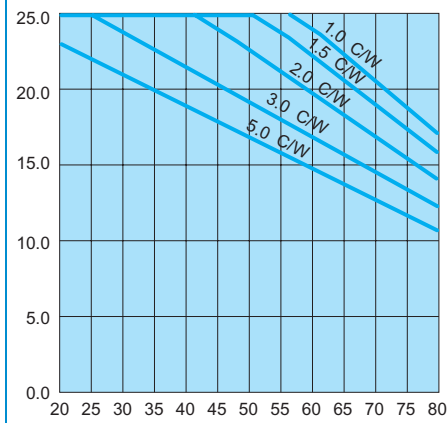
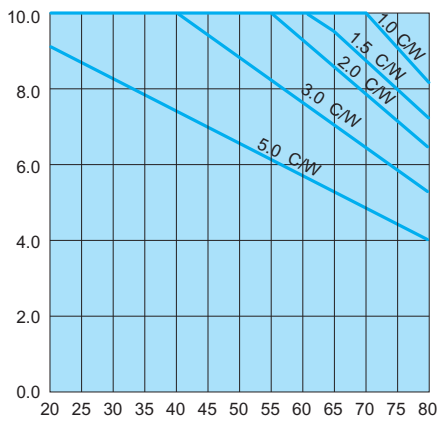

# DUAL two-phase solid state relay

## → DUAL

- Rating 2x25A or 2x40A
- Output voltage 24 to 280 V
- Back-to-back SCR
- Instantaneous or zero volt switching
- Input to output insulation voltage : 4000 V
- Protection by RC filter
- UL-Cul approval Tüv and CE marking



### Specifications

Type	Current	Output voltage	Input voltage	Switching	Code
Dual range	25 A	24 - 280 V AC	4 - 15 V DC	Zero voltage	84 140 000
	25 A	24 - 280 V AC	17 - 32 V DC	Zero voltage	84 140 010
	40 A	24 - 280 V AC	4 - 15 V DC	Zero voltage	84 140 200
	40 A	24 - 280 V AC	17 - 32 V DC	Zero voltage	84 140 210
	25 A	24 - 280 V AC	4 - 15 V DC	Instantaneous	84 140 100
	25 A	24 - 280 V AC	17 - 32 V DC	Instantaneous	84 140 110
	40 A	24 - 280 V AC	4 - 15 V DC	Instantaneous	84 140 300
	40 A	24 - 280 V AC	17 - 32 V DC	Instantaneous	84 140 310

### General characteristics

#### Output characteristics

Peak voltage (1 min) V(peak)	550
On-state voltage drop at I <sub>max</sub> and T = 25 °C V(peak)	1.6
Max. leakage current mA (rms)	7
Minimum current mA (rms)	100
Max 1 cycle surge A (rms) @ 25 °C	500 (25A) 780 (40A)
Max 1 second surge A (rms) @ 25 °C	150 (25A) 234 (40A)
I <sup>2</sup> t A <sup>2</sup> s	1041 (25A) 2435 (40A)
Static (off-state) dv/dt (V/μs)	500
Thermal resistance Junction to casing (°C/W)	0.6 (25A) 0.4 (40A)
Supply frequency range (Hz)	47 → 63
Cos φ (Zero voltage)	> 0.5

#### Inputs specifications

Turn-off voltage (V)	1 V DC
Maximum current at V <sub>max</sub> (mA)	32

#### Characteristics

Operating temperature (°C)	-40 → +80
Storage temperature (°C)	-40 → +100
Input to output insulation voltage V(rms)	4000
Dielectric strength V(rms)	2500
Input/output capacitance (pF)	8
Material housing	Self-extinguishing (UL 94 V)
Material baseplate	Zamak
Weight (g)	97

## Dimensions

B

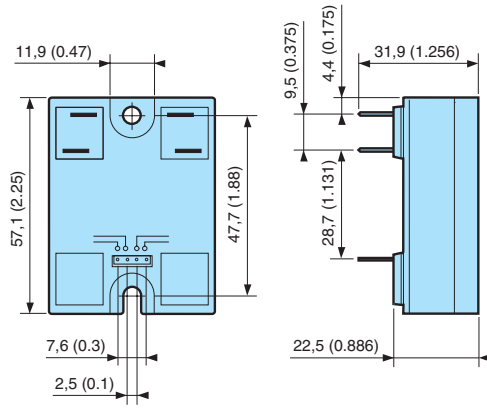

## Connections

Equivalent circuits

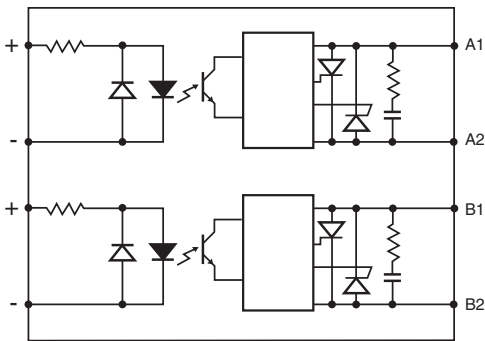

## Curves

25 A

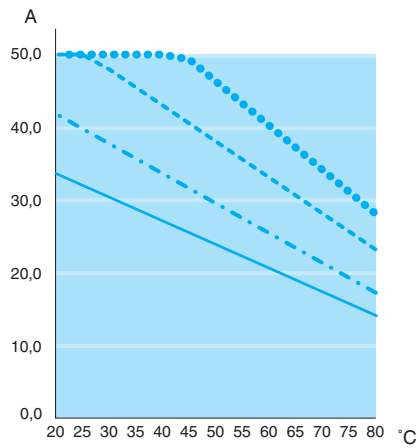

●●●● 0.7°C/W    - - - 1.5°C/W  
- - - 1.0°C/W    ——— 2.0°C/W

Dual SSR thermal curves with both outputs switched on at the same time

40 A

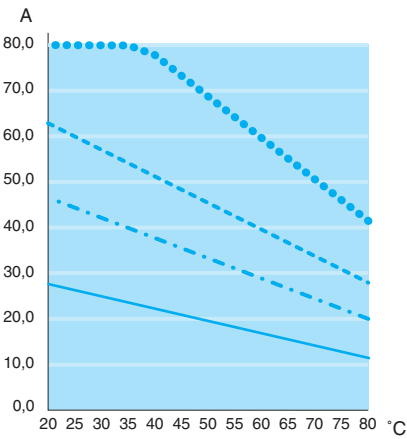

●●●● 0.5°C/W    - - - 1.5°C/W  
- - - 1.0°C/W    ——— 2.9°C/W

Dual SSR thermal curves with both outputs switched on at the same time

# GN single-phase

## → GN AC output

- EMC compatible for industrial environments
- built-in transient protections
- Optimum thermal response
- Regulated control input
- Control status LED
- Available with or without protective cover



### Specifications

Current	Output voltage	Input voltage	Instantaneous		Zero voltage	
			with cover	without cover	with cover	without cover
125 A	48-660 V AC	90-280 V AC/DC	84 137 381	84 134 381	84 137 181	84 134 181
125 A	48-660 V AC	18-36 V AC/DC	84 137 382	84 134 382	84 137 182	84 134 182
125 A	48-660 V AC	4-32 V DC	84 137 380	84 134 380	84 137 180	84 134 180
125 A	24-280 V AC	90-280 V AC/DC	84 137 281	84 134 281	84 137 081	84 134 081
125 A	24-280 V AC	18-36 V AC/DC	84 137 282	84 134 282	84 137 082	84 134 082
125 A	24-280 V AC	4-32 V DC	84 137 280	84 134 280	84 137 080	84 134 080
100 A	48-660 V AC	90-280 V AC/DC	84 137 341	84 134 341	84 137 141	84 134 141
100 A	48-660 V AC	18-36 V AC/DC	84 137 342	84 134 342	84 137 142	84 134 142
100 A	48-660 V AC	4-32 V DC	84 137 340	84 134 340	84 137 140	84 134 140
100 A	24-280 V AC	90-280 V AC/DC	84 137 241	84 134 241	84 137 041	84 134 241
100 A	24-280 V AC	18-36 V AC/DC	84 137 242	84 134 242	84 137 042	84 134 042
100 A	24-280 V AC	4-32 V DC	84 137 240	84 134 240	84 137 040	84 134 040
75 A	48-660 V AC	90-280 V AC/DC	84 137 331	84 134 331	84 137 131	84 134 131
75 A	48-660 V AC	18-36 V AC/DC	84 137 332	84 134 332	84 137 132	84 134 132
75 A	48-660 V AC	4-32 V DC	84 137 330	84 134 330	84 137 130	84 134 130
75 A	24-280 V AC	90-280 V AC/DC	84 137 231	84 134 231	84 137 031	84 134 031
75 A	24-280 V AC	18-36 V AC/DC	84 137 232	84 134 232	84 137 032	84 134 032
75 A	24-280 V AC	4-32 V DC	84 137 230	84 134 230	84 137 030	84 134 030
50 A	48-660 V AC	18-36 V AC/DC	84 137 322	84 134 322	84 137 122	84 134 122
50 A	48-660 V AC	90-280 V AC/DC	84 137 321	84 134 321	84 137 121	84 134 121
50 A	48-660 V AC	4-32 V DC	84 137 320	84 134 320	84 137 120	84 134 120
50 A	24-280 V AC	18-36 V AC/DC	84 137 222	84 134 222	84 137 022	84 134 022
50 A	24-280 V AC	90-280 V AC/DC	84 137 221	84 134 221	84 137 021	84 134 021
50 A	24-280 V AC	4-32 V DC	84 137 220	84 134 220	84 137 020	84 134 020
25 A	48-660 V AC	18-36 V AC/DC	84 137 312	84 134 312	84 137 112	84 134 112
25 A	48-660 V AC	90-280 V AC/DC	84 137 311	84 134 311	84 137 111	84 134 111
25 A	48-660 V AC	4-32 V DC	84 137 310	84 134 310	84 137 110	84 134 110
25 A	24-280 V AC	18-36 V AC/DC	84 137 212	84 134 212	84 137 012	84 134 012
25 A	24-280 V AC	90-280 V AC/DC	84 137 211	84 134 211	84 137 011	84 134 011
25 A	24-280 V AC	4-32 V DC	84 137 210	84 134 210	84 137 010	84 134 010
10 A	48-660 V AC	90-280 V AC/DC	84 137 301	84 134 301	84 137 101	84 134 101
10 A	48-660 V AC	18-36 V AC/DC	84 137 302	84 134 302	84 137 102	84 134 102
10 A	48-660 V AC	4-32 V DC	84 137 300	84 134 300	84 137 100	84 134 100
10 A	24-280 V AC	90-280 V AC/DC	84 137 201	84 134 201	84 137 001	84 134 001
10 A	24-280 V AC	18-36 V AC/DC	84 137 202	84 134 202	84 137 002	84 134 002
10 A	24-280 V AC	4-32 V DC	84 137 200	84 134 200	84 137 000	84 134 000

### Dimensions

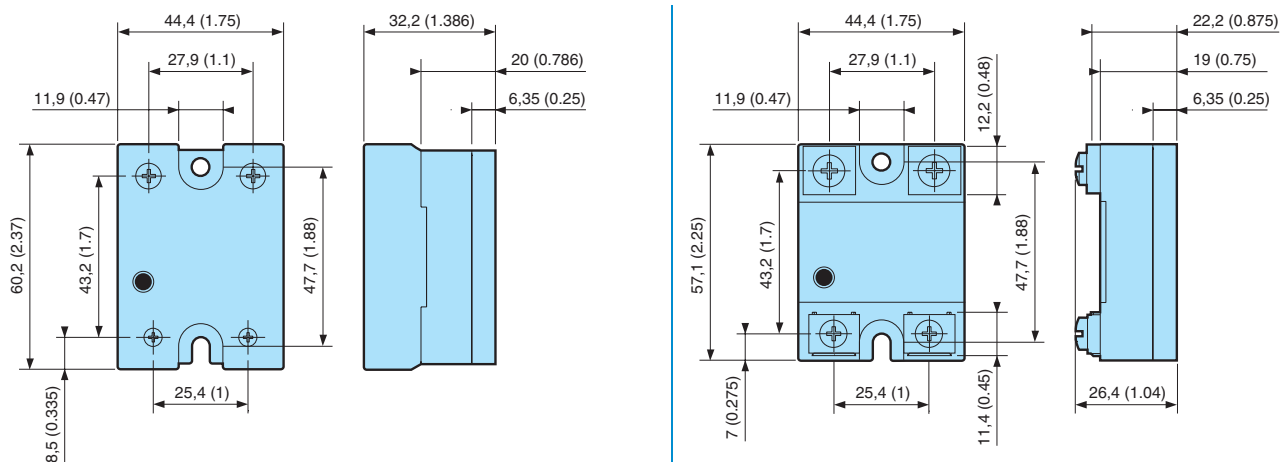

To order, see page 6



## General characteristics

### General characteristics

Operating temperature (°C)	-20 → +80
Storage temperature (°C)	-40 → +100
Input to output insulation voltage V(rms)	4000
Dielectric strength V(rms)	2500
Input/output capacitance (pF)	8
Frequency (Hz)	47 → 80
Material housing	polycarbonate UL-94V
Material baseplate	Zamak
Weight (g)	IP20 : 114 IP00 : 97

### Control specifications

Turn-off voltage (V)	4-32 VDC : 1V 18-36 VDC : 1V 90-280 VDC/AC : 10V
Max. controlled current (mA)	4-32 VDC : 14 18-36 VDC : 20 90-280 VDC/AC : 8.5
Turn-on time (ms) (zero voltage relay)	4-32 VDC : 8.33 (60Hz) - 10 (50Hz) 18-36 VDC : 20 90-280 VDC/AC : 20
Turn-on-time (ms) (instantaneous relay)	0.1
Response time on closing (ms)	4-32 VDC : 8.33 (60Hz) - 10 (50Hz) 18-36 VDC : 30 90-280 VDC/AC : 30

### Output specifications

Non-rep. peak voltage (Vp)	24-280 VAC : 600 48-660 VAC : 1200
Max. non-rep. 1 s surge (T=25 °C) (A)	10A : 300 25A : 500 50A : 780 75A : 1000 100A : 1200 125A : 1700
Max. non-rep.1-cycle surge (T=25 °C) (A)	10A : 80 25A : 150 50A : 235 75A : 300 100A : 360 125A : 510
Maximum off-state leakage at Vmax and T =25°C mA(rms)	24-280 VAC : 2.5 - 4.25 48-660 VAC : 2.75 - 4.75
Minimum current (mA)	100
I <sup>2</sup> t (50-60 Hz) (A <sup>2</sup> s)	10A : 375-450 25A : 1041-1250 50A : 2535-3042 75A : 4166-5000 100A : 6000-7000 125A : 12041-14450
Voltage drop at I <sub>max</sub> (T=25°C) (V)	10A : 1.4 25A : 1.4 50A : 1.35 75A : 1.3 100A : 1.3 125A : 1.25
Static dv/dt (V/μs)	500
Thermal resistance Junction to casing (°C/W)	10A : 0.4 25A : 0.4 50A : 0.25 75A : 0.155 100A : 0.155 125A : 0.15

## Curves

GN 10 AMP SSR (1200 & 600 V)

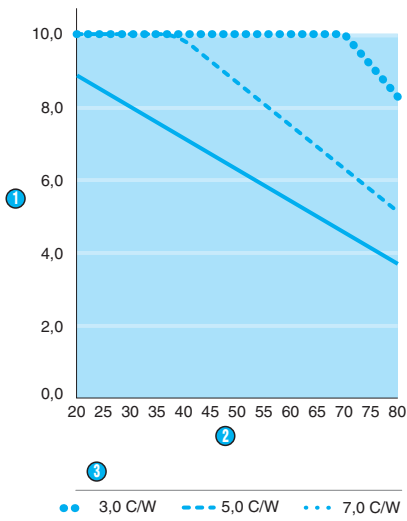

- ① Load current (A)
- ② Ambient temperature (°C)
- ③ Heatsink

GN 25 AMP SSR (1200 & 600 V)

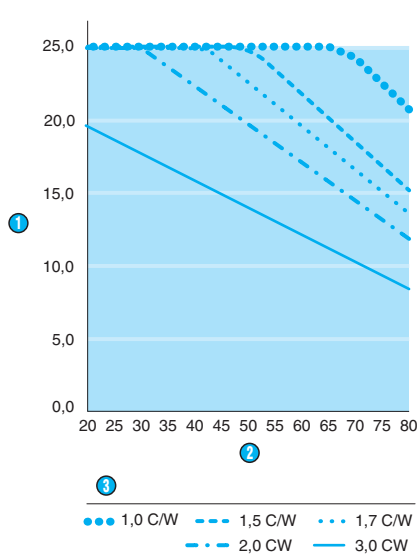

- ① Load current (A)
- ② Ambient temperature (°C)
- ③ Heatsink

GN 50 AMP SSR (1200 & 600 V)

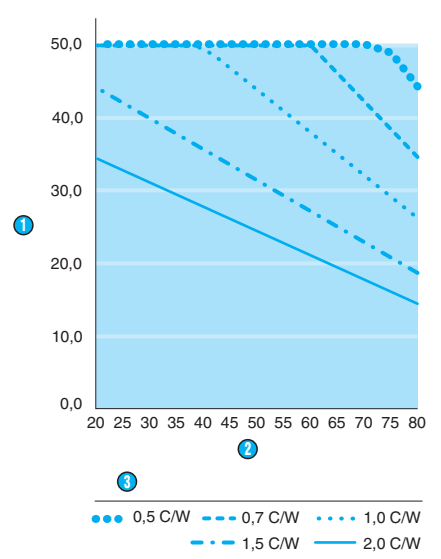

- ① Load current (A)
- ② Ambient temperature (°C)
- ③ Heatsink

GN 75 AMP SSR (1200 & 600 V)

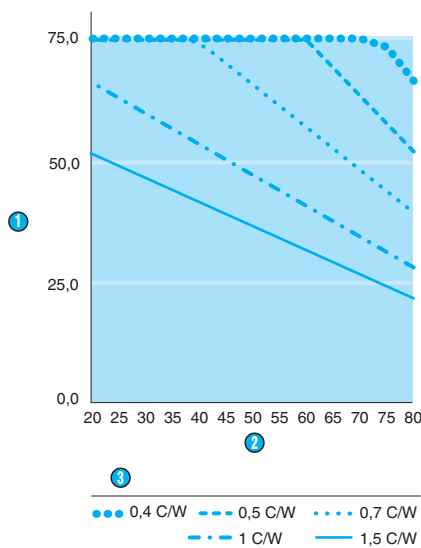

- ① Load current (A)
- ② Ambient temperature (°C)
- ③ Heatsink

GN 100 AMP SSR (1200 & 600 V)

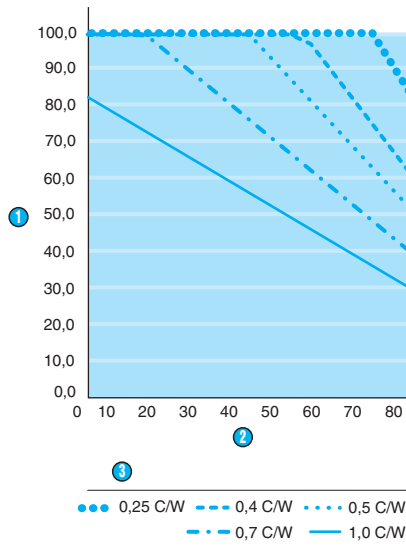

- ① Load current (A)
- ② Ambient temperature (°C)
- ③ Heatsink

GN 125 AMP SSR (1200 & 600 V)

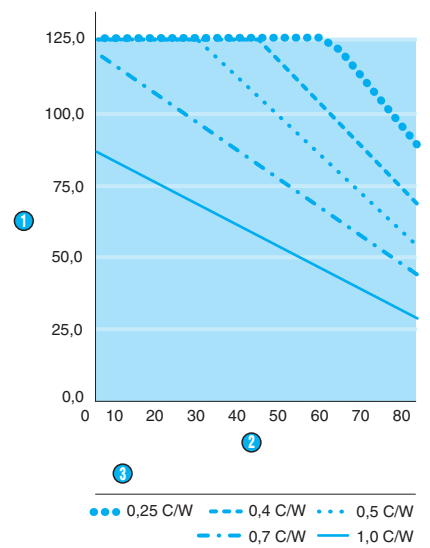

- ① Load current (A)
- ② Ambient temperature (°C)
- ③ Heatsink

5

# GMS single-phase DIN rail mounting

## → GMS range

- Complete, compact units
- DIN rail and panel mounting
- Input voltage 4-32 V DC regulated
- Input to output insulation voltage : 4 Kv
- LED display of input status
- Replaceable protection fuse
- UL-Cul approval and CE marking



### Specifications

Type	Switching	Current	Output voltage	Input voltage	Code
Transistor	zero voltage	3 A	5-48 V DC	4-32 V DC	84 130 104
17.5 mm	Zero voltage	5 A	12 - 280 V AC	4 - 32 V DC	84 130 105
	Instantaneous	5 A	12 - 280 V DC	4 - 32 V DC	84 130 108

### General characteristics

Operating temperature (°C)	-30 to +80
Storage temperature (°C)	-40 to +100
Input to output insulation voltage (Vrms)	4000
Input/output capacitance (pF)	8
Capacity of input and output terminals	With ferrule : 2 x 1.5 mm <sup>2</sup> , Without ferrule : 2 x 2.5 mm <sup>2</sup> and 1 x 4 mm <sup>2</sup>

### Dimensions

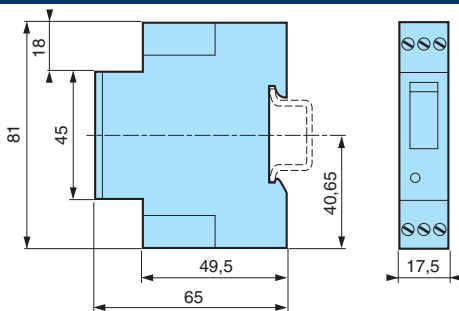

### Equivalent circuits

#### AC output module

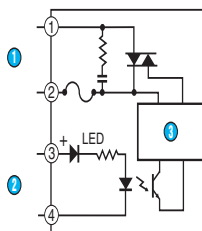

#### DC output module

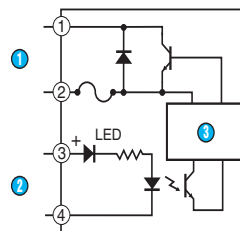

### Curves

#### Sortie AC

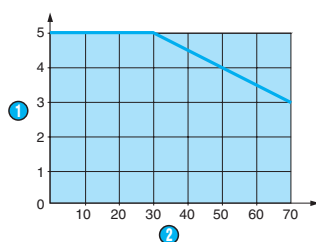

- ① Rating (Amps)
- ② Ambient temperature (°C)

#### Sortie DC

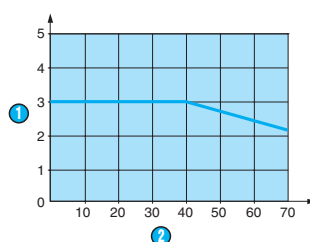

- ① Rating (Amps)
- ② Ambient temperature (°C)

To order, see page 6

For more information [www.crouzet.com](http://www.crouzet.com)

# Relay-heatsink assemblies

## → DIN rail mounting



### Specifications

Type	Relay	Sink	DIN rail adaptor	Protective cover	Code
GA0-25 A	84 067 441	26 532 762	26 532 764	26 532 797	84 067 449
GA3-25 A	84 028 451	26 532 762	26 532 764	26 532 796	84 028 459
GA3-25 A	84 068 451	26 532 762	26 532 764	26 532 796	84 068 459
GA3-25 A	84 068 453	26 532 762	26 532 764	26 532 796	84 068 409
GA3-45 A	84 068 651	26 532 762	26 532 764	26 532 796	84 068 659

Current (A)	Temperatures (°C)						Code
	20	30	40	50	60	70	
21	19	17	15	14	11	84 067 449	
24	22	19	17	15	12	84 028 459	
24	22	19	17	15	12	84 068 459	
24	22	19	17	15	12	84 068 409	
24	22	19	17	15	12	84 068 659	



# PCB-mountable

## → GA1 and GA8

- PCB-mountable (flat pack = GA1, SIP = GA8)
- Rating : 4 A-5 A
- Peak voltage : 600 V
- Will withstand a 1-cycle 100 A surge
- TRIAC outputs
- UL - cUL 3 A approval and CE marking
- Zero voltage or instantaneous switching (5A only)
- Input to output insulation voltage : 4000 V
- Protection by RC filter



### Specifications

Type	Current	Input voltage	Switching	Code
GA1 range	4 A	3 - 32 V DC	Zero voltage	84 064 131
GA8 range	3 A	3 - 32 V DC	Instantaneous	<b>84 025 040</b>
		3 - 32 V DC	Zero voltage	84 065 040
	4 A	3 - 32 V DC	Zero voltage	84 065 131
	5 A	3 - 32 V DC	Instantaneous	<b>84 025 030</b>
		3 - 32 V DC	Zero voltage	84 065 030

### General characteristics

#### Output characteristics

Voltage range V (rms) max	24-280 / 24-480
Peak voltage (1 min) V(peak)	24-280 : 600 24-480 : 850
Maximum current A(rms)	24-280 : 4 or 5 depending on part no. 24-480 : 3
Minimum current mA(rms)	0.05
Max. 1-cycle surge (A <sub>peak</sub> )	100
Max. leakage current (mA <sub>eff</sub> )	6
On-state voltage drop at I <sub>max</sub> and T = 25 °C V(peak)	24-280 : 1.6 24-480 : 1.65
Static (off-state) dv/dt (V/μs)	200
Response time (close) (cycle)	0.5
Frequency (Hz)	47 → 63

#### Inputs specifications

Input voltage	3-32 V DC
Turn-off voltage (V)	1 V DC
Max input current	25 mA (at V <sub>max</sub> )
Nominal input resistance (kΩ)	regulated

#### Characteristics

Operating temperature (°C)	-30 → +80
Storage temperature (°C)	-40 → +100
Input to output insulation voltage V(rms)	4000 V <sub>rms</sub>
Input/output capacitance (pF)	8
Weight (g)	15

## Dimensions

GA1

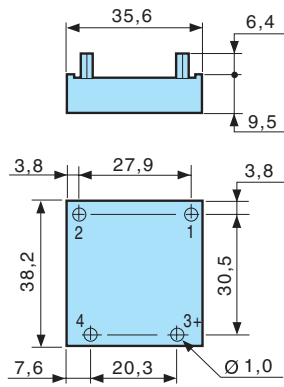

General tolerances  $\pm 0.5$

GA8

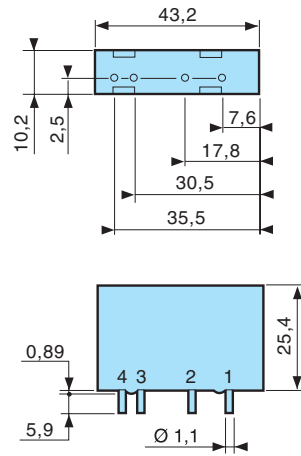

General tolerances  $\pm 0.5$

## Connections

Equivalent circuits

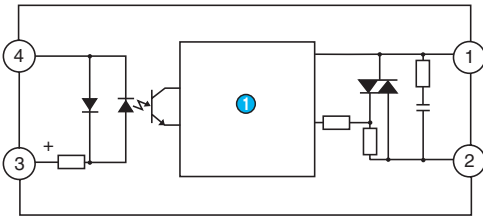

① Matching and trigger circuit (zero voltage)

## Curves

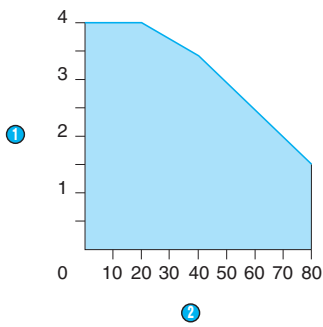

① Rating (Vpeak)  
② Ambient temperature

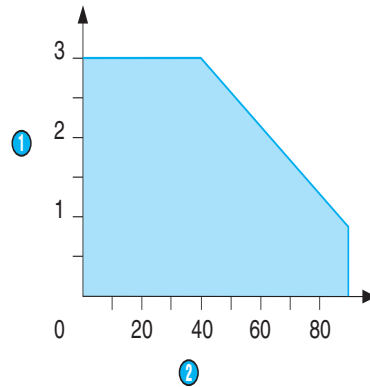

① Rating (Vpeak)  
② Ambient temperature (°C)

# SMART module

## → Control module for solid state relays

- Patented operating principle (96 050 16).
- Provides both visual and electrical information if a fault occurs in the circuit or on the solid state relay being controlled
- For mounting on single-phase "hockey-puck" type solid state relays.
- Peak voltage 1200 V AC : suitable for solid state relays with DC input and A AC output.
- Alarm output : 4-32 V = push-pull transistor.
- Optical isolation 4000 V AC.
- Conforms with EC low-voltage directive.



### Specifications

Type	Current	Output voltage	Input voltage	Code
" hockey puck "	15 → 35 mA	4 → 32 V DC	5 → 24 V DC	84 060 001

### General characteristics

#### Electrical characteristics

Maximum voltage (V DC)	32
Minimum voltage (V DC)	3
Max. voltage in stopped state (V DC)	1
Line voltage V(rms)	48 → 660
Peak voltage (1 min. max) V(peak)	1200
Leaking current (at maximum line voltage) mA (rms)	8

#### DC power supply / Alarm output

Voltage alarm output (V DC)	4 → 32
Current alarm output (mA)	60

#### Characteristics

Operating temperature range (°C)	-20 → +80
Storage temperature range (°C)	-40 → +100
Input / output insulation voltage (limited to 1 mA for 1 sec. - Ta = 25 °C) V(rms)	4000

### Dimensions

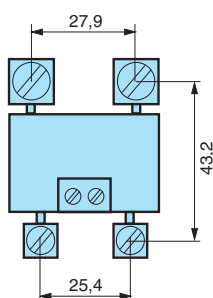



## Connections

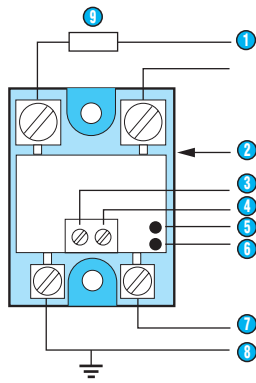

- 1 Mains 48-660 V AC
- 2 Solid state relay
- 3 Alarm output (4-32 V DC) (1)
- 4 Auxiliary power supply (4-32 V DC) (1)
- 5 Red LED : Alarm
- 6 Green LED : Input
- 7 SSR Input (3-32 V DC) (1)
- 8 Common
- 9 Load

The SSR input, the SMART MODULE alarm output and the SMART MODULE + power supply all share the same-terminal

## Curves

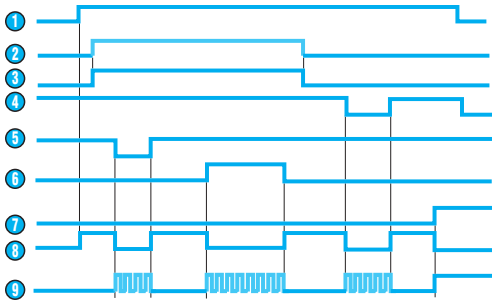

- 1 SMART SSR power supply
- 2 SSR input
- 3 Green LED
- 4 Mains presence
- 5 Load : closed circuit
- 6 SSR : external short-circuit on output terminals
- 7 SSR : output failed (internal short-circuit)
- 8 Alarm output
- 9 Alarm LED

### Operating principle

The SMART MODULE can be mounted on any single-phase solid state relay with DC input / AC output in a "hockey puck" casing. The SMART MODULE has constant power supply to ensure that both the relay and the load being controlled are functioning correctly. The SMART MODULE provides information on the relay status by means of an LED display and an alarm output.

### Operation

Power is supplied to the SMART MODULE between its 4-32 V DC terminal (+) and the - terminal of the solid state relay control input. During correct operation when the relay is not being controlled, the alarm output is at 4-32 VDC and the LED are off. During correct operation when the relay is not being controlled, the green LED is on and the alarm remains at 4-32 VDC. If the mains voltage is lost or there is a short-circuited on the relay output, the alarm output changes to 0 VDC and the red LED flashes. If the relay output is faulty, the alarm output changes to 0 VDC and the red LED comes on.

# Low cost solid state relays

## → GZ range

- Low-cost solid state relay - Triac output
- Extra-slim casing
- Output current 12 and 20 A
- Output voltages 24-280 V AC and 36-530 V AC
- Control input 4-15 V DC
- Version with low off-state leakage (no RC circuit)
- Optical isolation 4 KV
- UL-Cul approval and CE marking



### Specifications

Type	Current	Input voltage	Switching	Circuit RC	Code
GZ range	12 A	4 - 15 V DC	zero voltage	no	84 132 000
			Zero voltage	yes	84 132 200
			Instantaneous	no	84 132 100
			Instantaneous	yes	84 132 300
			Zero voltage	no	84 132 400
			Zero voltage	yes	84 132 600
			Instantaneous	no	84 132 500
	20 A	4 - 15 V DC	Instantaneous	yes	84 132 700
			Zero voltage	yes	84 132 610
			Zero voltage	no	84 132 010
			Zero voltage	yes	84 132 210
			Instantaneous	no	84 132 110
			Instantaneous	yes	84 132 310
			Zero voltage	no	84 132 410
			Zero voltage	no	84 132 510
			Instantaneous	yes	84 132 710

### General characteristics

#### Output characteristics

Voltage range V (rms) max	24-280 / 36-530
Peak voltage (1 min) V(peak)	600 (24-280) 800 (36-530)
Leakage current (mAeff)	24-280 : 4.2 36-530 : 5.3
Off-state leakage at Vmax and 25 °C - Low off-state leakage - no RC circuit (mA)	0.1
Static dv/dt - Standard (V/μs)	500
Static dv/dt Low off-state leakage-no RC circuit (V/μs)	250
Maximum current A(rms)	12 (24-280) 20 (36-530)
Minimum current mA(rms)	100
Max. 1-second surge A(peak)	24-280 : 36 36-530 : 60
Max. 1-cycle surge A(peak)	24-280 : 120 36-530 : 200
On-state voltage drop at I max V(peak)	24-280 : 1.65 36-530 : 1.55
I t (t = 10 ms) (A²s)	55
I²t (t = 8.33 ms) (A²s)	50
Frequency (Hz)	47 → 63
Thermal resistance Junction to casing (°K/W)	24-280 : 3 36-530 : 2.2

#### Inputs specifications

Input voltage	4 → 15 V DC
Turn-off voltage (V)	1
Max input current (mA)	24-280 : 32 ma @ 15 V DC 36-530 : 63 ma @ 15 V DC
Turn-on time (ms) (zero voltage relay)	0.5
Turn-on-time (ms) (instantaneous relay)	0.1
Response time on closing (cycle)	0.5

#### Characteristics

Operating temperature range (°C)	-20 → +80
Storage temperature range (°C)	-40 → +100
Input to output insulation voltage V(rms)	4 000
Dielectric strength V(rms)	2 500
Input/output capacitance (pF)	8

To order, see page 6

## Dimensions

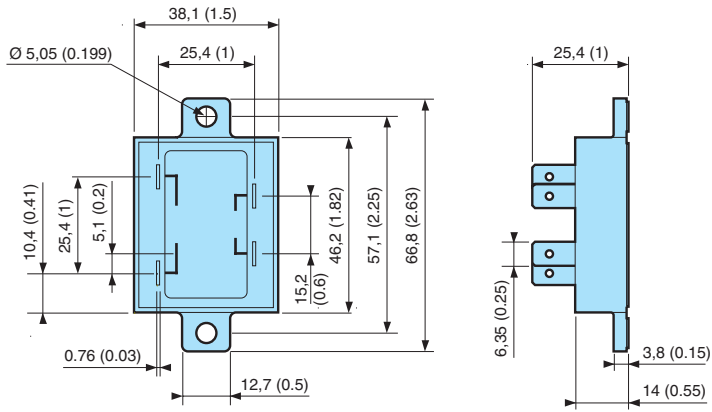

## Connections

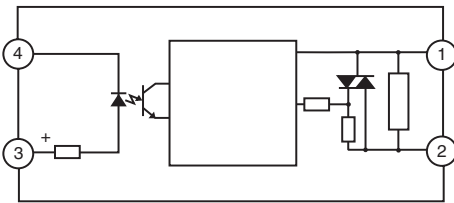

## Curves

### 12 A version

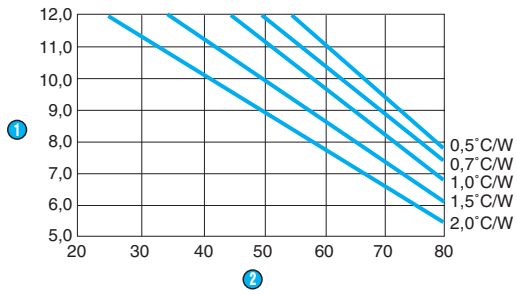

- ① Current A(rms)
- ② Ambient temperature (°C)

### 20 A version

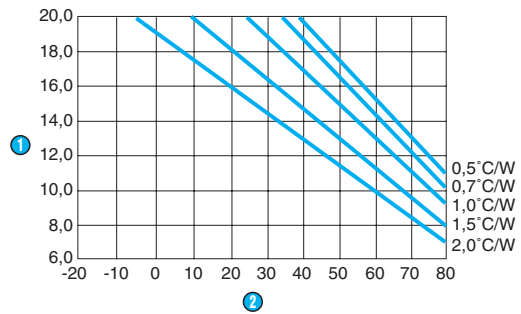

- ① Current A(rms)
- ② Ambient temperature (°C)

# GA three-phase

## → GA0 three-phase changeover

- Reverses rotation of three-phase motors
- Output voltage 24-480 V AC
- Input voltage 3-32 V AC
- Input to output insulation voltage : 100 ms
- Interlock against simultaneous actuation in both directions
- Back-to-back SCRs
- Input to output insulation voltage : 5000 V AC
- Protected by RC filter and overvoltage limiter
- Direction of rotation displayed by 2 green LEDs



### Specifications

Type	Current	Output voltage	Input voltage	Code
Alternative current	25 A	24 - 480 V AC	3 - 32 V DC	84 067 441

### Accessories

	Code
DIN rail heatsinks	26 532 764
Heat transfer compound	18 373 112
Protective cover	26 532 797

### General characteristics

#### Output characteristics

Peak voltage (1 min) V(peak)	1 000
Minimum current (mArms)	200
Max 1 cycle surge T = 25 °C A(rms)	270
Max. leakage current (mAeff)	10
I t (t = 10 ms) (A <sup>2</sup> s)	365
On-state voltage drop at I <sub>max</sub> and T = 25 °C V(peak)	1.6
Thermal resistance Junction to casing (°C / W)	0.2
Static (off-state) dv/dt (V/μs)	500
Frequency (Hz)	47 → 63
Response time (close) (ms)	0.2
Response time (open) (ms)	20
Reversing time (ms)	100

#### Inputs specifications

Input voltage	3 → 32 V DC
Turn-off voltage (V)	1
Max input current	20 mA (input regulated current and limited)
Nominal resistyance (+/-10 % at 25 °C) (kΩ)	1

#### Characteristics

Operating temperature (°C)	-20 → +80
Storage temperature (°C)	- 40 to + 100°C
Input to output insulation voltage V(rms)	5 000 V AC
Dielectric strength V(rms)	4000 V AC
Input/output capacitance (pF)	8
Material housing	Self-extinguishing
Material baseplate	aluminium
Weight (g)	455

## Dimensions

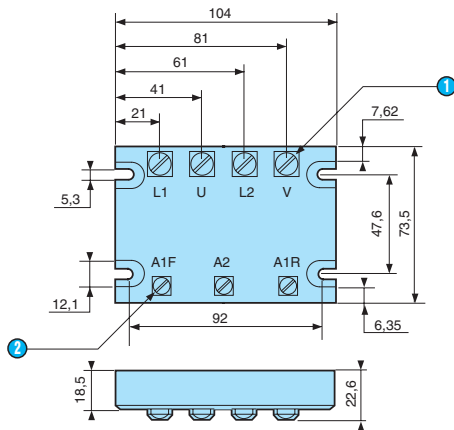

① 4 M4 screw

② 3 M3.5 screws

Tolérances générales  $\pm 0.5$

## Connections

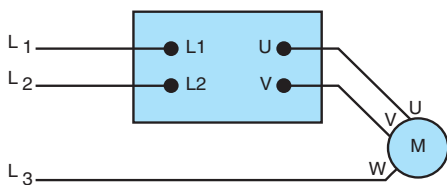

## Equivalent circuits

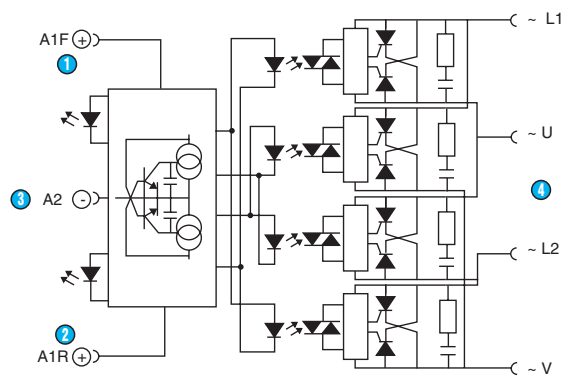

① Front

② Rear

③ Input

④ Output

## Curves

Thermal dissipation curves  
GA0 range - 25 A

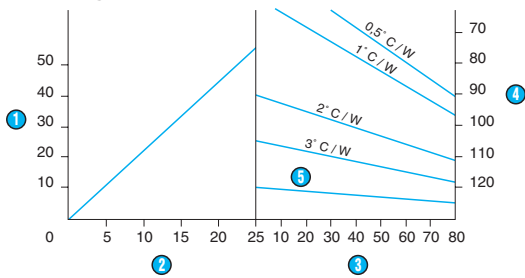

① Dissipated power (W)

② On-state current (A)

③ Ambient temperature ( $^{\circ}\text{C}$ )

④ Basseplate temperature ( $^{\circ}\text{C}$ )

⑤ No heatsink

# GA three-phase

## → GA3 three-phase

- For controlling three-phase loads
- Rating 10, 25, 45 A
- Output voltages to 660 Vrms
- Control voltage 4-32 V = or 90-280 V AC
- Peak voltage : 1200 V
- Back-to-back SCR output
- Input to output insulation voltage : 4000 Vrms
- Protected against overvoltages by RC filter and overvoltage limiter
- Zero voltage or instantaneous switching



### Specifications

Type	Current	Input voltage	Switching	Code
Range GA3	10 A	4 - 32 V DC	Instantaneous	84 028 251
		4 - 32 V DC	Zero voltage	84 068 251
		4 - 32 V DC	Instantaneous	84 028 451
		90 - 280 V AC	Instantaneous	84 028 453
	25 A	4 - 32 V DC	Zero voltage	84 068 451
		90 - 280 V AC	Zero voltage	84 068 453
		4 - 32 V DC	Instantaneous	84 028 651
		90 - 280 V AC	Instantaneous	84 028 653
	45 A	4 - 32 V DC	Zero voltage	84 068 651
		90 - 280 V AC	Zero voltage	84 068 653
		4 - 32 V DC	Instantaneous	84 028 651
		90 - 280 V AC	Instantaneous	84 028 653

### Accessories

	Code
Heatsink	26 532 762
DIN rail heatsinks	26 532 764
Heat transfer compound	18 373 112
Protective cover	26 532 796

### General characteristics

#### Output characteristics

Voltage range V (rms) max	24-660
Peak voltage (1 min) V(peak)	1200
Minimum current mA(rms)	200
Max. 1-cycle surge A(peak)	10A : 160 25A : 270 45A : 450
Leakage current (mAeff)	10
I t (t = 10 ms) (A <sup>2</sup> s)	10A : 128 25A : 365 45A : 1000
On-state voltage drop at I <sub>max</sub> and T = 25 °C V(peak)	1.6
Thermal resistance Junction to casing (°C / W)	10A : 0.25 25A : 0.25 45A : 0.2
Frequency (Hz)	47 → 63
Static (off-state) dv/dt (V/μs)	500
Response time (close) (ms)	10 ms max. (3-32 VDC) 20 ms max. (90-280 VAC)
Response time (open) (ms)	10 ms max. (3-32 VDC) 30 ms max. (90-280 VAC)

#### Inputs specifications

Max input current (mA)	10 (90-280 AC) 20 (4-32 DC)
Turn-off voltage (V)	10 AC (90-280 AC) 1 DC (4-32 DC)
Nominal resistance (kΩ)	1

#### Characteristics

Operating temperature (°C)	-20 → +80
Storage temperature (°C)	-40 to +100
Input to output insulation voltage V(rms)	4000
Breakdown voltage (T=25°C, 1 s) V(rms)	4000
Input/output capacitance (pF)	< 8
Insulation resistance	10 <sup>4</sup>
Material housing	Self-extinguishing
Material baseplate	aluminium
Weight (g)	450

To order, see page 6

## Dimensions

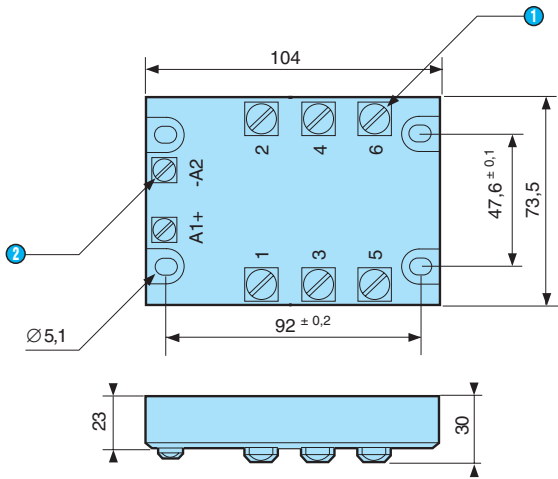

- 1 6 M4 screws
- 2 2 M3.5 screws

## Connections

### Equivalent circuits

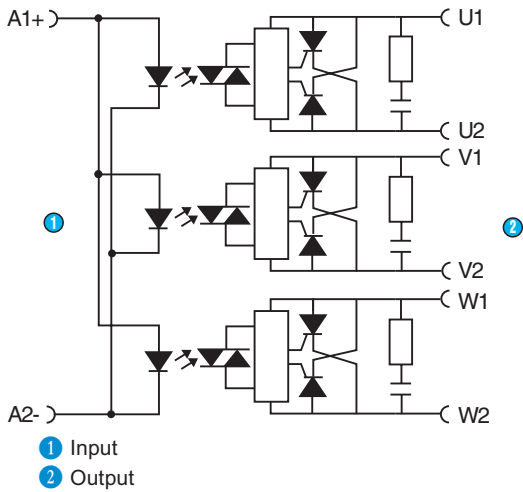

- 1 Input
- 2 Output

## Curves

GA3 range - 10 A

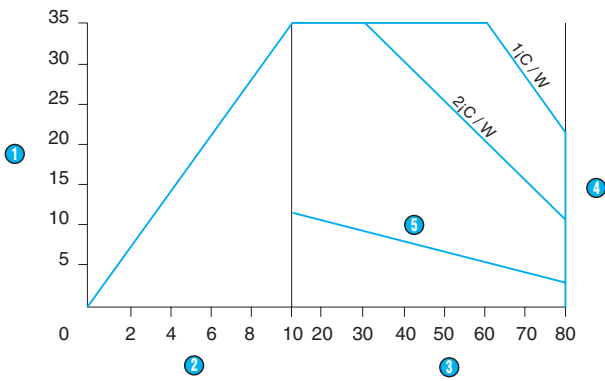

- ① Dissipated power (W)
- ② On-state current (A)
- ③ Ambient temperature (°C)
- ④ Baseplate temperature (°C)
- ⑤ No heatsink

GA3 range - 25 A

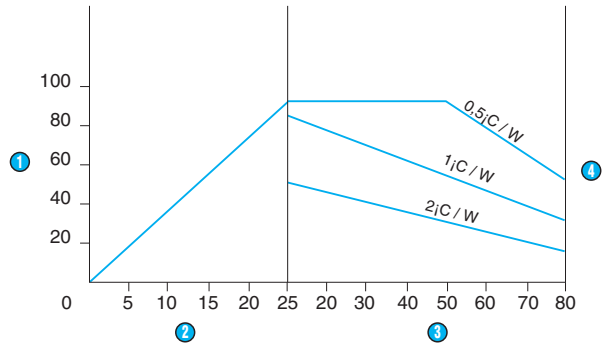

- ① Dissipated power (W)
- ② On-state current (A)
- ③ Ambient temperature (°C)
- ④ Baseplate temperature (°C)
- ⑤ No heatsink

GA3 range - 45 A

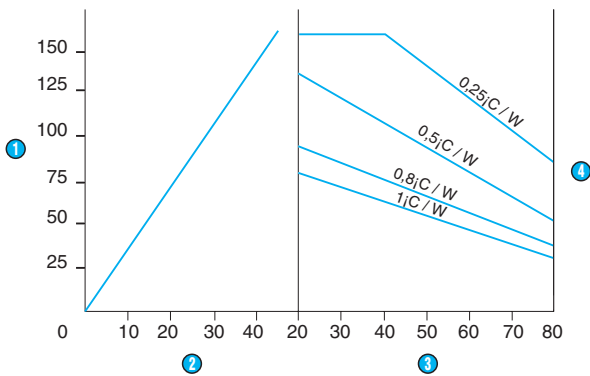

- ① Dissipated power (W)
- ② On-state current (A)
- ③ Ambient temperature (°C)
- ④ Baseplate temperature (°C)



# Accessories for solid state relays

## THERMSTRATE® heat seal

Part numbers **1**

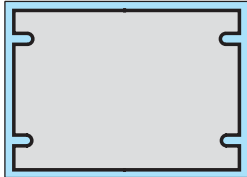
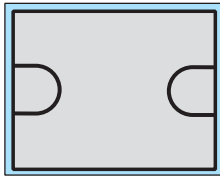

### Characteristics

Particular attention must be paid to thermal considerations in order to improve the reliability and power of solid state relays. It is extremely important to consider the quality of the interface between the relay and the heatsink (ROCs). Air pockets or gaps risk causing hot spots and a significant rise in temperature. Compared with the published thermal dissipation curves, performance is likely to be inferior or inconsistent. See the power curves and the description of heat transfer and of the heatsink presented in the corresponding individual technical data sheets.

We are pleased to offer cut-out pads of Thermstrate® thermal interface which replace messy and uneven heat transfer compounds. This pad is made of an aluminium substrate covered on each side with a "touch-dry" thermal compound. If the temperature exceeds 51°C, the thermal compound wetting action allows it to fill any gaps, while its natural capillary action draws it to the edge of the interface between the mating surfaces, thus preventing it spreading.

To order a supply of pads with the corresponding relay, please specify:

– For the G, GA5, GF and GT ranges	26 532 720
– For the 3-phase GA0 range and the GA3 range	26 532 721

Sold in packs of 25 (representing 1 lot) per part number.

Thermstrate is a registered trademark of Power Devices, Inc.

## Heat transfer compound

Part number **1**

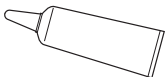

### Characteristics

Material: silicon/zinc oxide paste  
Weight: 20 g

18 373 112

## “FERRAZ” quick-blow fuses

Part numbers **1**

To ensure that the solid state relay is fully protected, we recommend the use of quick-blow fuses. Their role is to protect the solid state relay against short-circuits. The fuse rating is determined as follows :  $I^2t$  fuse <  $I^2t$  relay. Use the table below to determine the appropriate “FERRAZ” fuse for the solid state relay you have selected.

These fuses can be obtained from your usual “FERRAZ” distributor (please consult us for a list of stockists).

- Very high breaking capacity fuses for protecting power semi-conductors.
- $I^2t$  fuse <  $I^2t$  solid state relay

Range	Max. rating (Arms)	$I^2t$ relay (A <sup>2</sup> s)	Fuse part number
GN	10	240	Contact us
	25	310	
	50	2800	
	75	2800	
	100	6000-7000	
GA5	125	12041-14450	
	10	50	
GA3	25	310	
	10	128	
GA0	15	365	
	45	1000	
GA1 / GA8	25	365	
	4		

## Protection for solid state relays

Part numbers **1**

Type	Range		
Varistor	GA3 - G (36-530 V ~ and 48-660 V ~)	In packs of 10	26 532 741
	GA0	Single	26 532 742
Fuses for GMS relays	GMS 3 A and C 4	In packs of 10	26 532 730
	GMS 5 A	In packs of 10	26 532 731

# Accessories for solid state relays

## Heatsinks

Part numbers

1

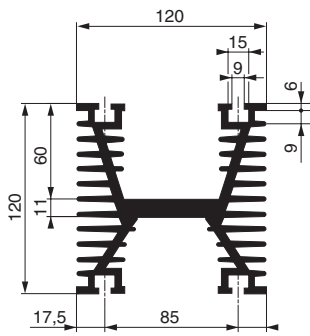

	Range	Thermal resistance	Length	Weight	
1 phase	G, GA5, GT, GF,	0.6° C/W	L = 100 mm	950 g	26 532 790
	GN	1° C/W	L = 60 mm	570 g	26 532 759
Material: black anodised aluminium					

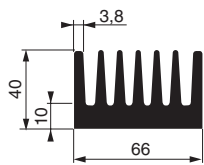

	Range	Thermal resistance	Length	Weight	
1 phase	G, GA5, GT, GF, GN	2° C/W	L = 70 mm	260 g	26 532 760
Material: black anodised aluminium					

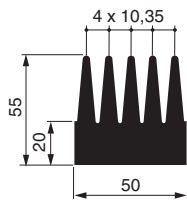

	Range	Thermal resistance	Length	Weight	
1 phase	G, GA5, GT, GF, GN	3° C/W	L = 58 mm	250 g	26 532 761
Material: black anodised aluminium					

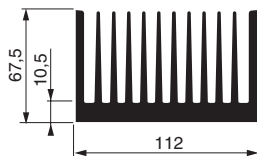

	Range	Thermal resistance	Length	Weight	
3 phases or 2 x 1 phase	2 x G, GA5, GT, GF,	0.7° C/W	L = 75 mm	655 g	26 532 762
	1 x GA0, GA3, GN				
Material: black anodised aluminium					

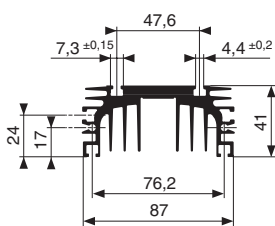

	Range	Thermal resistance	Length	Weight	
1 phase	G, GA5, GT, GF, GN	2° C/W	L = 50 mm	150 g	26 532 758
Material: black anodised aluminium					

## Adaptors for fixing on panel (set of 4)

Part number

1

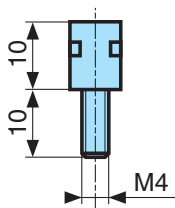

Heatsink	26 532 758	26 532 801
----------	------------	------------

# Accessories for solid state relays

## Protective cover

Part number

1

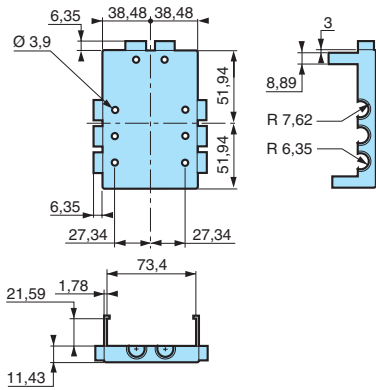

**Characteristics**  
Fits GA3 range

**Material**  
Polycarbonate UL 94 V0

26 532 796

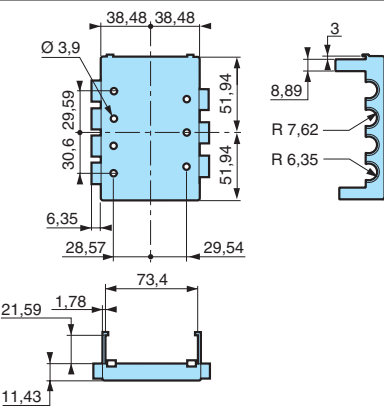

**Characteristics**  
Fits GA0 range

**Material**  
Polycarbonate UL 94 V0

26 532 797

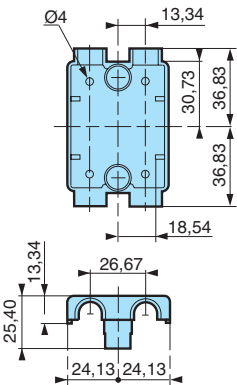

**Characteristics**  
Fits G, GA5, GF  
GA5, GF and GT

**Material**  
Polycarbonate UL 94 V0

**Weight**

5 g

26 532 798

## DIN rail adaptor

Part number

1

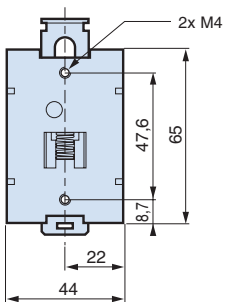

**Characteristics**

Suitable for use with heatsinks  
26 532 760, 26 532 761 and 26 532 762

**Weight**

55 g

26 532 764



# Solid state I/O modules





Module type	Control voltage	Output type	Max. switching voltage	Min. current	Max. current		
Output module	5 V DC	Transistor 2 A	5 to 48 V DC	1 mA	2 A	Page 202	
		Triac 0.5 A	24 to 250 V AC	0.1 mA	0.5 A		
	24 V DC	Transistor 0.5 A	5 to 48 V DC	24 to 250 V AC	0.1 mA	0.5 A	Page 202
		Transistor 2 A			1 mA	2 A	
		Triac 0.5 A	24 to 250 V AC	0.1 mA	0.5 A		
		Triac 1 A	10 to 280 V AC	10 mA	1 A		
		1 changeover relay	250 V AC/DC	10 mA/12 V DC	6 A		
	24 V AC/DC	1 changeover relay	250 V AC/DC	10 mA/12 V DC	6 A	Page 202	
	110 V AC/DC	1 changeover relay	250 V AC/DC	10 mA/12 V DC	6 A	Page 202	
		Transistor 0.5 A	5 to 48 V DC	0.1 mA	0.5 A		
	230 V AC	Triac 0.5 A	24 to 250 V AC			1 mA	2 A
		Transistor 0.5 A	5 to 48 V DC				
		Transistor 2 A					
230 V AC/DC	1 changeover relay	250 V AC/DC	10 mA/12 V DC	6 A	Page 202		
Input module	24 V DC	1 changeover relay	30 V AC/36 V DC	1 mA/12 V DC	50 mA	Page 200	
		1 NO relay	30 V AC/36 V DC				
	24 V AC/DC	1 changeover relay	30 V AC/36 V DC	1 mA/12 V DC	50 mA		
	110 V AC/DC	1 changeover relay	30 V AC/36 V DC	1 mA/12 V DC	50 mA		
	230 V AC/DC	1 changeover relay	30 V AC/36 V DC	1 mA/12 V DC	50 mA		



# Input and output modules

## → Input module SImm

A range of space-saving modules for isolation of input signals.

- Only 6.2 mm wide and 65 mm deep.
- DIN rail mounting.
- Built-in LED shows the status of the input signal for diagnostic purposes.
- Bridges enable quick and easy linking of the common voltages to save time and reduce installation errors.
- Identification zone on front face.
- Connection by screw terminals.



### Specifications

Type	Control voltage	Control voltage range	Current consumption	Code
Changeover relay output 50 mA - 30 VAC / 36 VDC	24 VDC	19.2 → 30 VAC / DC	20 mA	84 145 061
	24 VAC / DC	19.2 → 30 VAC / DC	20 mA	84 145 062
	110 VAC / DC	95 → 121 VAC / DC	5 mA	84 145 064
	230 VAC / DC	195 → 253 VAC / DC	5 mA	84 145 066
Normally open relay output 50 mA - 30 VAC / 36 VDC	24 VDC	19.2 → 30 VDC	20 mA	84 145 071

### General characteristics

Response time (close) (ms)	8
Response time on closing (ms)	10
Operating frequency (maxi)	10 Hz
Mechanical life (operations)	≥ 10 x 10 <sup>6</sup>
Electrical life (number of operations)	6 x 10 <sup>6</sup>
Protection rating	IP 20
Operating temperature (°C)	-25 → +60
Storage temperature (°C)	-40 → +80
Weight (g)	35
Contact	AgSnO <sub>2</sub> gold plated

### Dimensions

#### Changeover relay output

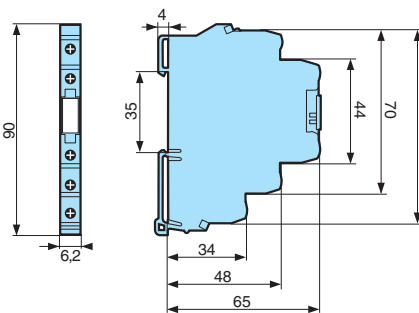

#### Normally open relay output

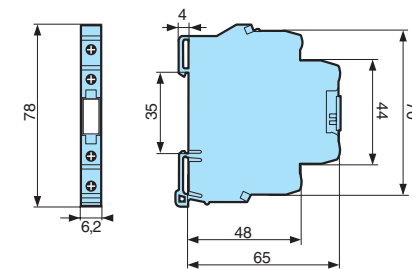

### Connections

#### 84 145 061 / 062 / 064 / 066

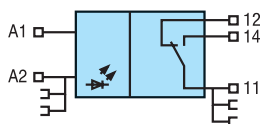

#### 84 145 071

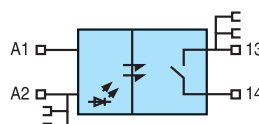



## Curves

84 145 061 / 062 / 064 / 066

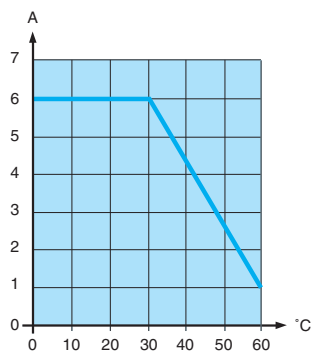

## Using information

Exceeding the value given for the output relay current will remove the gold plating from the contacts and we cannot then guarantee correct operation at low currents.

# Input and output modules

## → Output module SImm

A range of space-saving modules for isolation of input signals.

- Only 6.2 mm wide and 65 mm deep.
- DIN rail mounting.
- Built-in LED shows the status of the input signal for diagnostic purposes.
- Bridges enable quick and easy linking of the common voltages to save time and reduce installation errors.
- Identification zone on front face.
- Connection by screw terminals.



### Specifications

Type	Control voltage	Control voltage range	Turn-off voltage (V)	Max. current	Current consumption	Code
Transistor output 0.5 A - 5 à 48 V DC	24 V DC	10 → 44 V DC	5 V DC	2 A	6 mA	84 145 001
	110 V AC/DC	70 → 130 V AC/DC	30 V AC/DC	2 A	7 mA	84 145 004
	230 V AC	90 → 230 V AC	40 V AC	2 A	8.5 mA	84 145 005
Transistor output 2 A - 5 à 48 V DC	5 V DC	4 → 5.5 V DC	2 V DC	7 A	6 mA	84 145 010
	24 V DC	10 → 44 V DC	3 V DC	7 A	6 mA	84 145 011
	230 V AC	90 → 230 V AC	40 V AC	7 A	7 mA	84 145 015
Triac output 0.5 A - 24 à 250 V AC	5 V DC	4 → 6.2 V DC	2 V DC	2 A	6 mA	84 145 020
	24 V DC	10 → 44 V DC	3 V DC	2 A	6 mA	84 145 021
	110 V AC/DC	70 → 130 V AC/DC	35 V AC/DC	2 A	6 mA	84 145 024
	230 V AC	140 → 250 V AC	80 V AC	2 A	7 mA	84 145 025
Triac output 1 A - 24 à 250 V AC	24 V DC	10 → 44 V DC	3 V DC	40 A	6 mA	84 145 031
Relay output 6 A - 250 V AC	24 V DC	19.2 → 30 V DC	-	-	20 mA	84 145 041
	24 V AC/DC	19.2 → 30 V AC/DC	-	-	20 mA	84 145 042
	110 V AC/DC	95 → 125 V AC/DC	-	-	5 mA	84 145 043
	230 V AC/DC	195 → 253 V AC/DC	-	-	5 mA	84 145 046

### Dimensions

#### Transistor or triac outputs

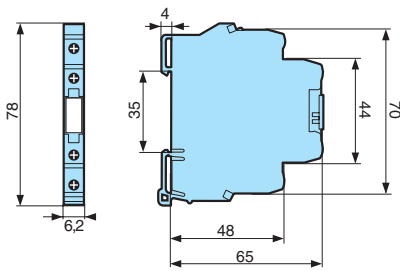

#### Changeover relay output

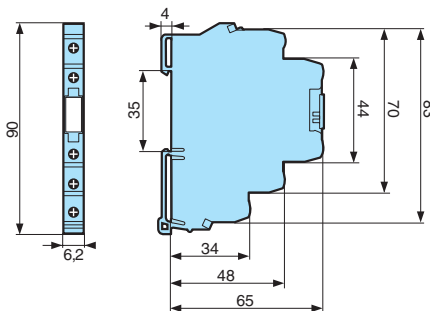

### Connections

84 145 001 / 004 / 005  
84 145 010 / 011 / 015

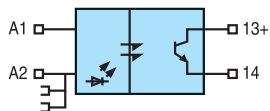

84 145 020 / 021 / 024 / 025

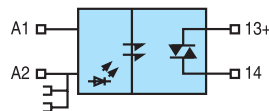

84 145 031

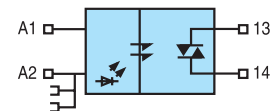

84 145 041 / 042 / 043 / 046

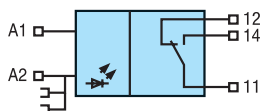

To order, see page 6

## Curves

84 145 001 / 004 / 005

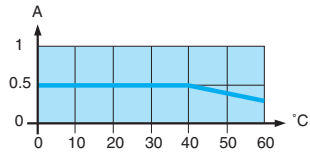

84 145 010 / 011 / 015

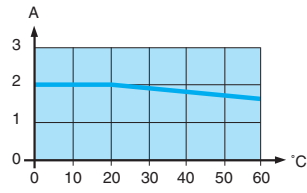

84 145 020 / 021 / 024 / 025

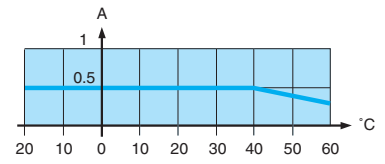

84 145 031

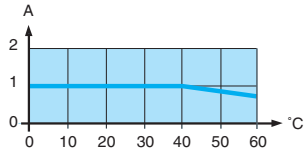

84 145 041 / 042 / 043 / 046

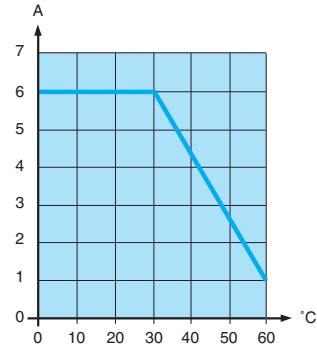

# Solid state I/O **modules** and mounting **boards**

## Industrial format

Its imaginative design enables either input or output modules to be connected to the mounting boards. The boards can be used to create applications with between 4 and 32 channels.



Made to order products : Please consult us

[www.crouzet.com](http://www.crouzet.com)



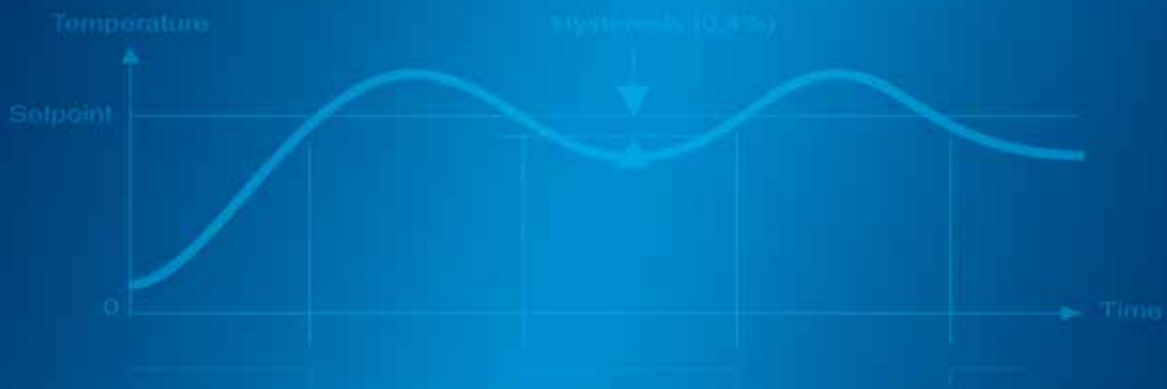

6

# Temperature controllers

429.5°C





Action type	Input type	Control type	Alarm	Number of displays	Designation	Temperature	Output 1	Output 2	Supply voltage		
Heating	Resistance temperature detector PT 100 (2-wire)	Digital or Proportional derivative	-	-	CT 48 A	(-50 to +30°C)	Relay 5A	-	230 VAC	Page 210	
	(0 to +40°C)										
	(0 to +120°C)										
	Thermocouple J					(0 to +200°C)					
	Thermocouple K					(0 to +400°C)					
						(0 to +250°C)					
						(0 to +450°C)					
						(0 to +600°C)					
						(0 to +800°C)					
						(0 to +1200°C)					
Heating AND/OR Cooling	Universal configurable: Resistance temperature detector PT 100 (2-3-wire)/ Thermocouples J-K-R-S-L-N/Voltage	PID with adaptive tune	1	1 (4 digits)	CTD 24		Relay 3A	Relay 3A	100 to 240 VAC	Page 219	
							24 VAC/DC				
	Resistance temperature detector PT 100 (3-wire)/ Thermocouples J-K-R-S-T-L-N/ Voltage/current		2	2 (4 digits)	MIC 48 Without MODBUS J.BUS RS 485 <sup>(1)</sup> link	Relay 3A	Relay 1A	Solid state	100 to 240 VAC	Page 212	
						24 VAC/DC					
					MIC 48 With MODBUS J.BUS RS 485 <sup>(1)</sup> link	Relay 3A		Solid state	100 to 240 VAC		
						Relay 3A			24 VAC/DC		
Heating OR Cooling	Resistance temperature detector PT 100 (3-wire)/ Thermocouples J-K-L-N	PID with adaptive tune	1	1 (3 digits)	CTD 43	Relay 3A	Relay 1A	Solid state	100 to 240 VAC	Page 216	
					24 VAC/DC						
				2 (3 digits)	CTD 46	Relay 3A		Solid state	100 to 240 VAC		
						Relay 3A			24 VAC/DC		
Heating AND Cooling	Resistance temperature detector PT 100 (3-wire)/ Thermocouples J-K-L-N	PID with adaptive tune	-	2 (3 digits)	CTH 46	Relay 3A	Relay 1A	Solid state	100 to 240 VAC	Page 216	
						Relay 3A		Solid state	24 VAC/DC		

(1) Optional Modbus-Jbus RS 485 link on request for MIC 48 controllers

With this function, the controller performs initial auto tuning of the PID control parameters and performs adaptive tuning of these parameters during operation

## COMMON FUNCTIONS FOR THE RANGE OF DIGITAL CONTROLLERS

### SMART function : auto-tune and adaptive tune

The entire range incorporates an algorithm known as SMART. This algorithm calculates the PID control parameters automatically on starting (auto-tune) and during the process if any changes occur (adaptive tune) without any user intervention.

#### → Starting period

The SMART function triggers its auto-tune action to calculate the PID parameters.

This enables an optimum approach to reaching the setpoint.

#### → During the process

The SMART function triggers its adaptive tune action to recalculate the PID parameters if there is a change in the setpoint or a modification to the load.

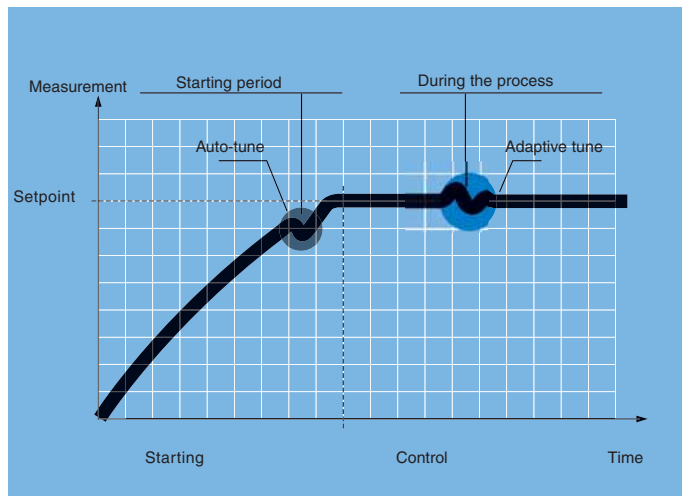

### SOFT-START function : gradual preheating

This function provides gradual preheating of the process.

This makes it possible to prolong the lifetime of the heating element and avoid any thermal shocks.

If you require this function, simply set the required output power (OLH) for preheating as well as its action time (t OL).

On starting, the inhibition function for the temperature threshold alarm ensures that no fault indication will be acknowledged during preheating.

In addition, these controllers also offer the possibility of programming a ramp to gradually increase power to further limit the risk of thermal shocks.

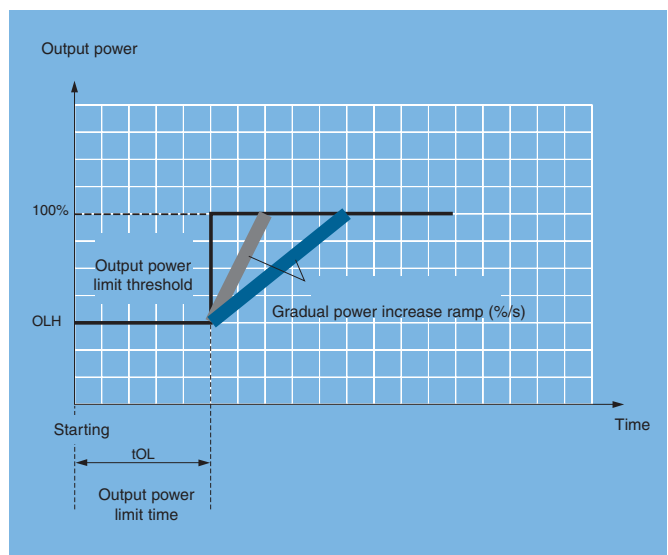

### OFFSET function : constant offset value

There are many applications where it is often difficult to install a sensor in the most ideal location.

Indeed, in several cases, the sensor is installed quite far away from the desired location.

Installing a sensor at such a distance can generate a measured value which is not actually representative of the process value.

It is for this reason that our controllers offer the possibility of programming a constant shift value known as an OFFSET. This OFFSET is the difference between the actual temperature to be measured and the temperature of the location where the sensor is installed. Thus, the value read on the controller is that of the temperature at the monitoring point and not the value at the sensor installation point.

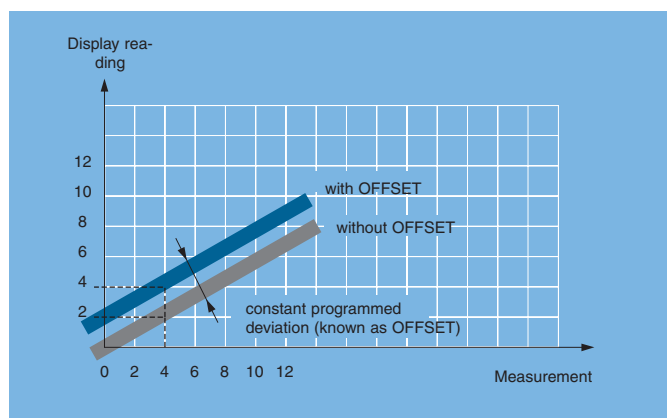



## ADDITIONAL FUNCTIONS ONLY AVAILABLE ON THE MIC 48 AND CTD 24

### Two independent ramps for switching from one setpoint to another.

Some processes require a ramp with a gradual increase in power to reach a new setpoint value. In addition, this ramp may require a different gradient in order to switch from one setpoint to another. This second value may be higher or lower than the original. For example, a process may require a rapid heating period and a slow cooling period.

It is for this reason that the MIC offers these two options. Two ramps can be programmed independently - one to rise from «SP A» to a higher setpoint value «SP B» and the second to reduce to a lower setpoint «SP C».

**Note:**

This function can also be applied to switching from SP to SP2.

SP : Normal operating temperature of the process

SP2 : Temperature when idle.

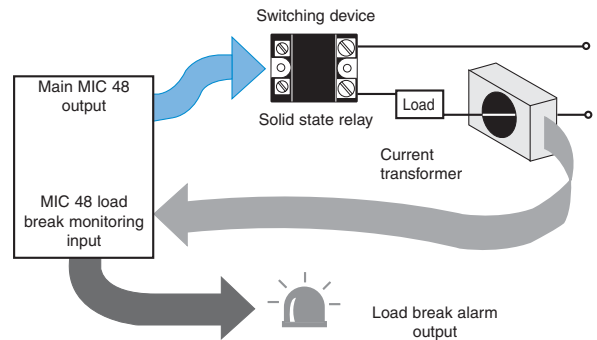
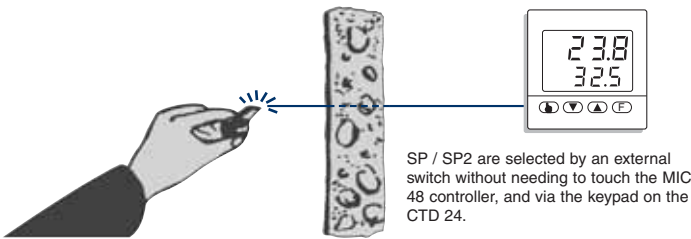
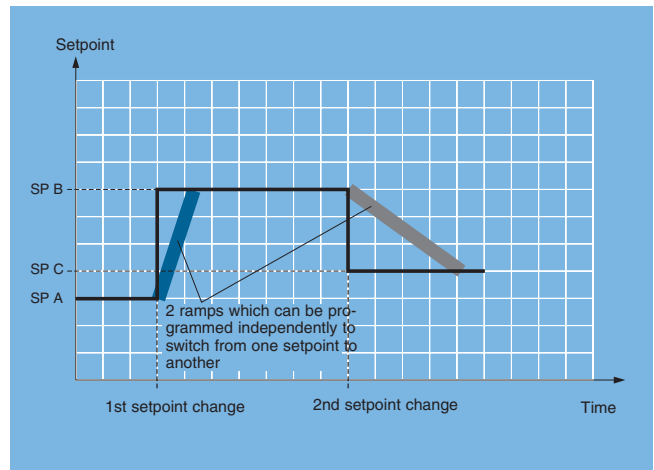

### Heating element break monitoring function

This function continuously monitors current at the load. It informs the user immediately of a break in the heating element. MIC 48: Loads up to 100 A can be checked using an external current transformer. In addition, the load current can be monitored during the process. Its value in amps can be read directly by pressing the (F) key. CTD 24: The software integrates this function without a sensor.

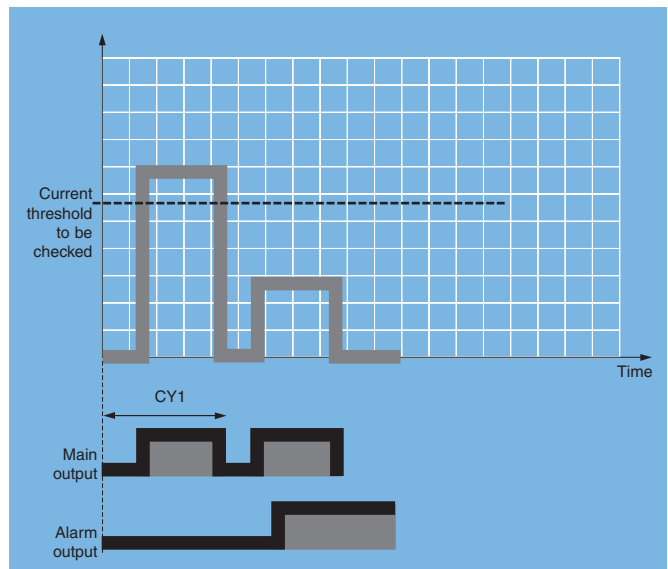

### Communication via the RS 485 serial link compatible with C.BUS, MODBUS and J.BUS protocol

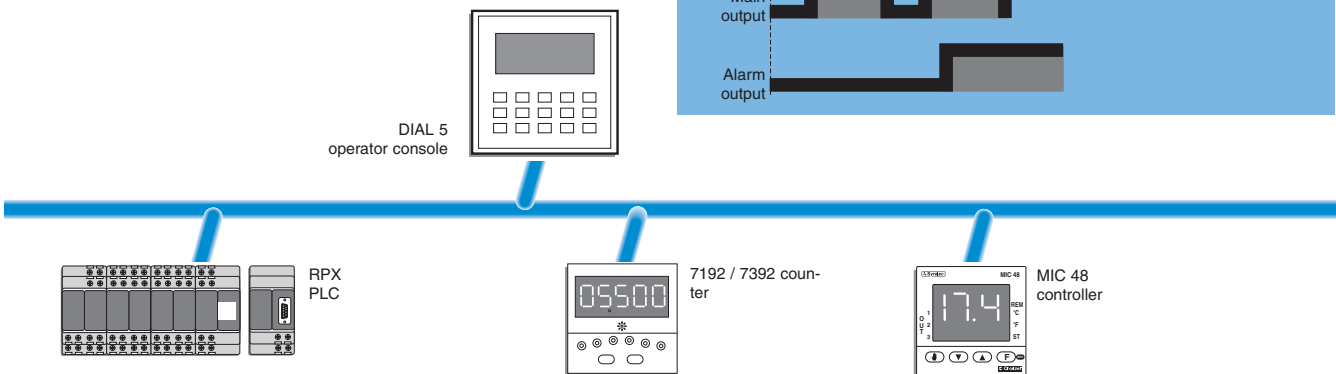

# Analogue temperature controllers

## → CT48A

- Input by J-K thermo-couple or by thermo-resistance Pt 100 (2-wire)
- 2 regulation modes : ON/OFF or proportional derivative selected by wiring
- Relay output



### Specifications

Type	Designation	Temperatures	Scale divisions	Code	
CT48A	Resistance temperature detector PT 100	- 50 + 30	2°C	89 420 207	
		0 + 40	1°C	89 420 217	
		0 + 120	2°C	89 420 227	
		0 + 200	5°C	89 420 237	
		0 + 400	10°C	89 420 257	
		Thermocouple J	0 + 250	10°C	89 420 047
			0 + 450	10°C	89 420 067
			0 + 600	10°C	89 420 097
		Thermocouple K	0 + 800	20°C	89 420 077
			0 + 1200	20°C	89 420 087

### Accessories

	Code
Solder tag connector 8-pin	25 622 301
Screw terminal or connector socket - 8-pin	25 622 303
Protective cover IP 54	79 237 709

### General characteristics

Supply voltage Un	230 to 240 VAC 50/60 Hz
Operating range	0.85 to 1.15 x Un
Maximum power consumption	2 VA
<b>Inputs</b>	
Thermocouple according to IEC 584	J - K
Automatic cold-junction compensation	For J - K : semi-conductor
Max. line resistance	150 Ω
Resist. temp. detector Pt 100 according to IEC 751	2-wire
Derating following line resistance	1 °C / 0.4 Ω
Derating with regard to the setpoint	J - K : ≤ 1 °C
Per 10 °C variation in ambient temperature	Pt 100 : ≤ 0.1 °C
Derating with regard to the setpoint	J - K : ≤ 1 °C
Per 10 Ω of line resistance variation	
Derating with regard to the setpoint	≤ 0.1 %
Per 10% variation in supply voltage	
<b>Operation</b>	
ON/OFF output action	0.4 %
Fixed hysteresis	
Derived proportional output action	3 %
Fixed proportional band (% of full scale)	
Derived proportional output action	22 s
Period proportional band	
<b>Output</b>	
Changeover relay	5 A / 250 V AC max.
Mechanical life (operations)	3x10 <sup>5</sup>
Behaviour in the event of sensor failure	Relay in rest position
Scale evolution	80 mm
Display accuracy J-K (full scale)	± 2 %
Display accuracy Pt 100 (of the full scale)	± 1.5 %
Temperature limit operation (°C)	0 ° → +55
Temperature limits stored (°C)	-20 → +70
Insulation according to standard VDE 0110	Group C for 250
Protection class according to DIN 40050 Casing	IP20
Protection class according to DIN 40050 Front panel	IP41
Mounting	Clip
Connection	Solder terminals socket, 8 poles
Weight (g)	350

To order, see page 6

## Dimensions

### Panel cut-out

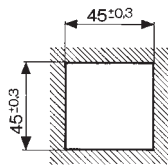

### Connector socket

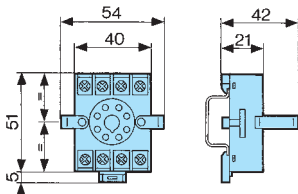

### Screw terminal or connector socket - 8-pin base : ref. 25 622 303 for panel mounting

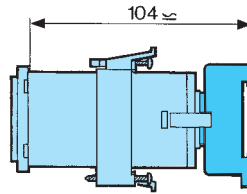

### Screw terminal or connector socket - 8-pin base : ref. 25 622 303 for mounting on DIN rail 35 mm EN 50022

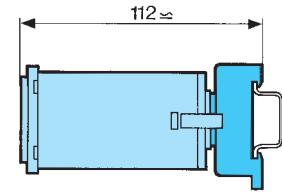

### Solder tag connector, 8-pin : ref. 25 622 301

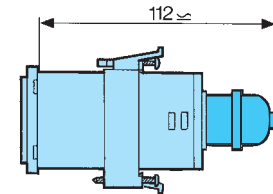
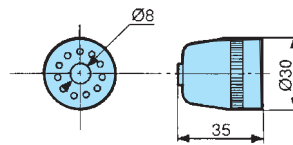

### Protective cover - IP 54 : 79 237 709

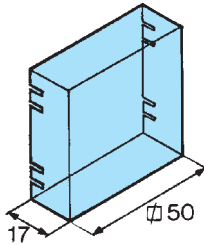

### Dimensions - mounting

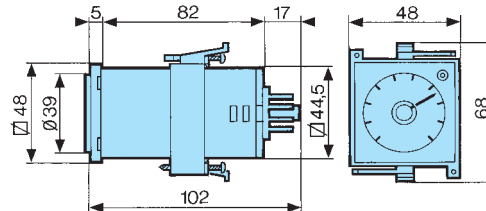

## Connections

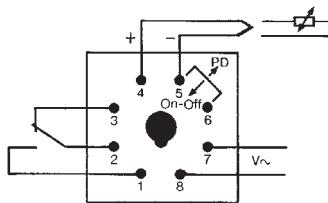

## Curves

### ON/OFF output action - CT48A

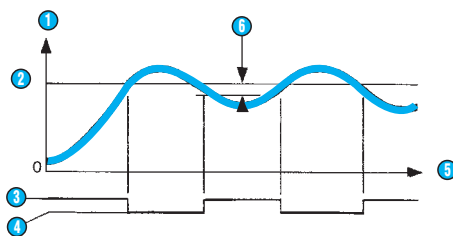

- ① Temperature
- ② Setpoint
- ③ Output ON
- ④ Output OFF
- ⑤ Time
- ⑥ Hysteresis (0.4 %)

### Proportional derivative (PD) action - CT48A

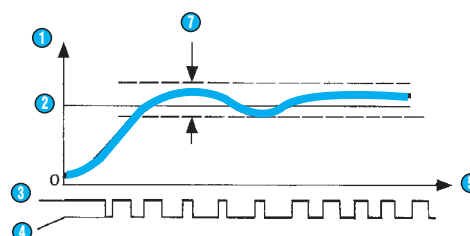

- ① Temperature
- ② Setpoint
- ③ Output ON
- ④ Output OFF
- ⑤ Time
- ⑦ Proportional band (PB)

## Other information

Other possible output type : solid state 0 Other possible supply voltages : 24 V AC and 110 V AC. Please consult us.

# Digital temperature controllers MIC 48

## → MIC48

- Heating and / or cooling function
- 2 independent alarms
- Load break detection
- 2 setpoint which can be selected remotely
- Manual / automatic power adjustment
- RS 485 / MODBUS-JBUS serial communication option



### Specifications

Type	Voltages	Output	Code
Without RS 485 link	100 to 240 VAC	Relay	89 422 008
		Logic	89 422 018
	24 VACDC	Relay	89 422 002
		Logic	89 422 012
With RS 485 link	100 to 240 VAC	Relay	89 422 408
		Logic	89 422 418
	24 VACDC	Relay	89 422 402
		Logic	89 422 412

### Accessories

	Code
Current transformers 10 A / 50 mA	26 852 301
Current transformers 25 A / 50 mA	26 852 302
Current transformers 50 A / 50 mA	26 852 303
Current transformers for EIT 100 A / 50 mA	26 852 304

### Dimensions

MIC 48

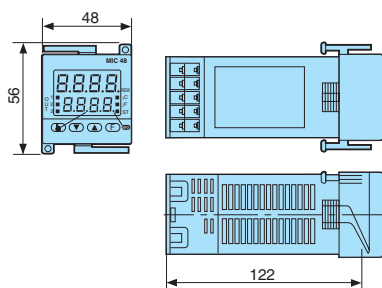

Current transformer

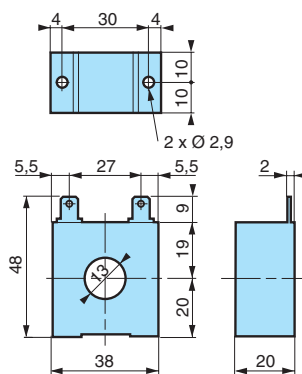

Panel cut-out

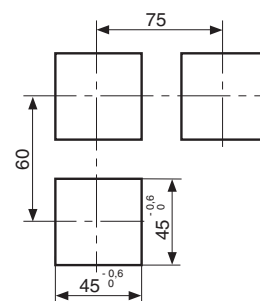

## Connections

### Relay output

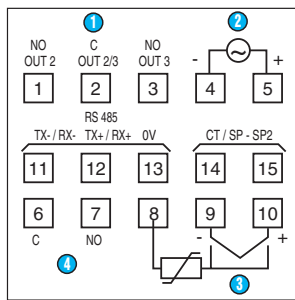

- ① 250 V AC / 2A resistive
- ② Supply
- ③ Linear
- ④ Main output 250 V AC / 3 A resistive

11-12-13 : Serial link  
 14-15 : Input 50 mA AC (Current transformer connected for load break monitoring or selection of 2nd setpoint)

### Logic output

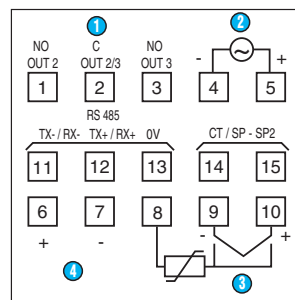

- ① 250 V AC / 2A resistive
- ② Supply
- ③ Linear
- ④ Main output 250 V AC / 3 A resistive

11-12-13 : Serial link  
 14-15 : Input 50 mA AC (Current transformer connected for load break monitoring or selection of 2nd setpoint)

## Applications

### Display

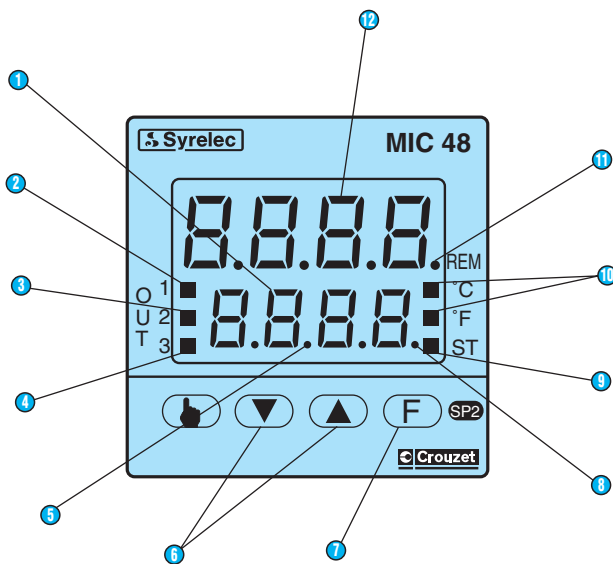

- ① Lower display : - setpoint - output power - heating element consumption (in amps) - abbreviation of the parameter selected during programming
- ② Main output status LED, lit when the output is active.
- ③ Cool output or alarm 1 output status LED, lit when the output is active
- ④ Load break alarm output and/or alarm output 2 status LED, lit when the output is active
- ⑤ Manual/automatic operation. The LED flashes when the controller is in manual mode
- ⑥ Parameter modification and direct access to the setpoint
- ⑦ Parameter selection and validation in configuration and parameter definition modes. This key is also used to display the output power and the heating element consumption
- ⑧ SP2 LED flashes slowly when control occurs at setpoint SP2. SP2 LED flashes rapidly when the setpoint value is programmed via the RS485 serial link
- ⑨ LED indicating the SMART function
- ⑩ When the sensor input is connected to a thermocouple or a Pt100, the LED corresponding to the selected unit of measurement is lit
- ⑪ REM LED on when the controller is communicating via the RS485 serial link
- ⑫ Upper display : -measurement -parameter values during programming

# Digital temperature controllers MIC 48

## → MIC48

General characteristics	
Supply	100 to 240 VAC, 24 VACDC
Frequency (Hz)	50 / 60
Tolerance	-15 % +10 % Un
Consumption	8 VA max.
Display measurement	red LEDs-4 digits, 7 segment , height 10 mm
Display setpoint	green LEDs-4 digits, 7 segment, height 7.5 mm
Serial link	
Type	RS485
Protocol	MODBUS, J.BUS
Address	1 → 255
Number of data bits	8
Transmission speed	600 → 19 200 Bauds
Parity	even, odd, no
Stop bit	1
Physical details and protection	
Insulation resistance conforming to IEC 348	> 100 MΩ
Insulation voltage according to IEC 348	1500 V
Immunity to interference conforming to IEC 801-4	Level 3
Immunity to interference conforming to IEC 801-2	8000 V
Accuracy	± 0.2 % of the full measurement scale ± 1 digit at an ambient temperature of 25 °C at Un
Temperature limit operation (°C)	0 → +50
Temperature limits stored (°C)	-20 → +70 °C
Relative humidity (no condensation)	20 → 85 % Rh
Housing	
Material housing	self-extinguishing UL94 grade VO
Front panel	Polycarbonate membrane
Protection class according to IEC 529 (IEC 70-1)	IP 54
Connection	screw terminals
Weight (g)	250
Approvals	
UL / CSA	in progress
Protection	
Safe-guard	detects a fault in the equipment caused by external interference and activates automatic reset without modification of the process.
Switch	the configuration and calibration are accessed via an internal switch, can only be accessed when the device is unplugged.
Control characteristics	
Control algorithm	PID with auto-tune and adaptive tune : SMART
Control type	heat or cool heat / cool
Sampling time linear input	250 ms
Sampling time TC and RTD input	500 ms
Proportional band Pb heat or cool	1.0 to 100 % of scale amplitude
Proportional band Pb heat - cool	1.5 to 100 % of scale amplitude
Proportional band Pb	-
Note : if Pb = 0 % discrete action	
Hysteresis (during discrete action)	0.1 to 10 % of scale amplitude
Integral time ti	20 s to 20 min
Note : if ti > 20 min	integral action is inactive
Derivative time td.	1 s to 10 min
Note : if td=0	derivative action is inactive
Cycle time heating	1 s → 200 s
Cycle time cooling	1 s → 200 s
Heat-cool control	rC x heat proportional band
Cool proportional band	
Heat-cool control rC : relative gain	0.20 → 1.00
Heat-cool control dead.overlap band	-20 % to + 50 % of the heat proportional band

Characteristics	
Inputs	
Thermocouples J, K, R, S, and N	IEC 584-1
Thermocouples L	DIN 43710
Reference junction	Automatic cold junction compensation : 0 to 50 °C (Thermocouples)
Reference junction drift	0.1 °C / °C
Input impedance (kΩ)	> 1 M Ω
Calibration (IEC 584-1)	•
Resist. temp. detector 3-wire Pt 100 conforming to DIN 43760	•
Line resistance	20 Ω max. (Resistance temperature detector)
Input type and standard range TC	L (0/400°C) (0/1650°F) (0/900°C) J (0/400°C) (0/1830°F) (0/1000°C) K (0/400°C) (0/2190°F) (0/1200°C) N (0/1400°C) (0/2550°F) R (0/1760°C) (0/3200°F) S (0/1760°C) (0/3200°F)
Input types and standard rangeRTD Pt100	(-199.9/400.0°C) (-199.9/400.0°F) (-200/800°C) (-330/1470°F)
Measurement range	
Decimal point	adjustable : - - - - , - - - - . , - - . - - , - - - -
Current transformer input for monitoring the load break	
Input	50 mA AC
Measurement range with transformer	10 A → 100 A
Resolution	10 to 20 A : 0.1 A 21 to 100 A : 1 A
Measurement logic threshold	Relay output : NO or NC Logic output : level 1 or 0
Measurement update period	50 ms
Setpoints	- main setpoint : SP - auxiliary setpoint : SP2
Selection input SP/SP2	50 mA AC selection via external N/C type contact
Output	
Type of output	discontinuous
Action type	can be programmed for heating and/or cooling
Limitation of output power : SOFT-START- heat action	adjustable from 0 to 100 %
Limitation of output power : SOFT-START-heat/cool action	adjustable from -100 to +100 %
Output specification	
OUT 1 Main output N/O contact	3A 250 V AC resistive (N/C contact is possible via a jumper)
OUT 1 Main output logic	Level 0 : <0.5 V DC Level 1 : 14 V DC±20 % @ 20 mA max 24 V DC±20 % @ 1 mA max
Main output cycle time	1 s → 99 s
OUT 2 Cool output or alarm 1 output	N/O-2A contact, 250 V AC resistive output
OUT 3 Load break output and/or alarm 2 output	N/O-2A contact, 250 V AC resistive output
Description of alarms 1 and 2	
Type of output	direct or reverse
Functions	absolute alarm band alarm deviation alarm
Reset to zero	Manual / automatic
Inhibition	Configuration
Alarm threshold - absolute alarm	absolute value independent from SP
Alarm threshold - band alarm	value relative to SP, adjustable from 0 to 500 °C/°F
Alarm threshold - deviation alarm	value relative to SP, adjustable from -500 °C/°F (negative deviation) to + 500°C/°F (positive deviation)
Alarm	0.1 to 10 % of scale amplitude



# Digital temperature controllers CTH/CTD

## → CTD 43/46

### CTH 46

- Heating / cooling function
- Measurement and setpoint display CTD 43

### CTD 43

- Heating or cooling function
- Measurement display
- Measurement deviation display-Setpoint via LED
- 1 configurable alarm CTD 46

### CTD 46

- Heating or cooling function
- Measurement and setpoint display
- 1 configurable alarm



## Specifications

Type	Supply voltage	Output	Code
CTH 46	100 → 240 V AC	Relay	89 422 508
		Logic	89 422 518
	24 V AC DC	Relay	89 422 502
		Logic	89 422 512
CTD 43	100 → 240 V AC	Relay	89 421 108
		Logic	89 421 118
	24 V AC DC	Relay	89 421 102
		Logic	89 421 112
CTD 46	100 → 240 V AC	Relay	89 422 108
		Logic	89 422 118
	24 V AC DC	Relay	89 422 102
		Logic	89 422 112

## Connections

### CTH 46 relay output

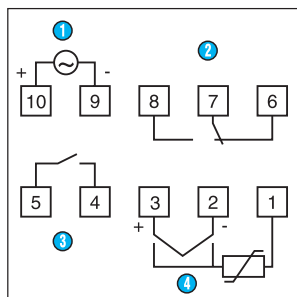

- 1 Supply
- 2 Main output 250 V AC / 3A resistive
- 3 Cool output 250 V AC / 1 A resistive
- 4 14-15 : Input 50 mA AC (Current transformer connected for load break monitoring or selection of 2nd setpoint)

### CTH 46 logic output

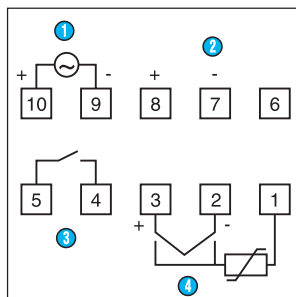

- 1 Supply
- 2 Main output 0-24 V DC / 20 mA max
- 3 Cool output 250 V AC / 1 A resistive
- 4 14-15 : Input 50 mA AC (Current transformer connected for load break monitoring or selection of 2nd setpoint)

### CTD 43 relay output

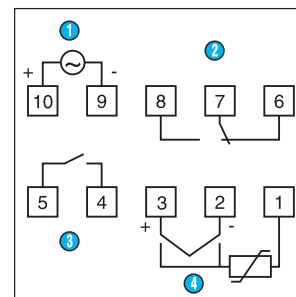

- 1 Supply
- 2 Main output 250 V AC / 3 A
- 3 Alarm output 250 V AC / 1 A
- 4 Thermocouple or resistance temperature detector connection

### CTD 43 logic output

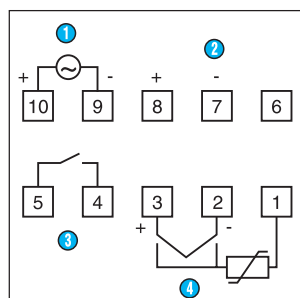

- 1 Supply
- 2 Main output 0-24 V DC / 20 mA max
- 3 Alarm output 250 V AC / 1 A
- 4 Thermocouple or resistance temperature detector connection

To order, see page 6



## General characteristics

Supply	100 to 240 VAC
Frequency (Hz)	50 / 60
Tolerance	-15 % +10 % Un
Consumption	5 VA
Display CTD 43	Measurement or setpoint : red LEDs, 3-digit, 7-segment, height 10 mm
Display CTH 47 / CTD 46	Measurement : red LEDs, 3-digit, 7-segment, height 10 mm Setpoint : green LEDs, 3-digit, 7-segment, height 7.5 mm

### Protection

Switch	the configuration and calibration are accessed via an internal switch, which can only be accessed when the equipment is disconnected
--------	--

### Physical details and protection

Insulation resistance conforming to IEC 348	> 100 MΩ
Insulation voltage according to IEC 348	1500 V
Immunity to interference conforming to IEC 801-4	Level 3
Immunity to interference conforming to IEC 801-2	8000 V
Accuracy	± 0.3 % of the full measurement scale at an ambient temperature of 25 °C at Un
Temperature limit operation (°C)	0 → +50 °C
Temperature limits stored (°C)	-30 → +70 °C
Relative humidity (Rh no condensation)	20 → 85 %

### Housing

Material housing	self-extinguishing UL94 VO grade
Front panel	polycarbonate membrane
Protection class according to IEC 529 (IEC 70-1)	IP 54
Connection	screw terminals
Weight (g)	160
Approvals	UL/CSA

### Characteristics

#### Inputs

Thermocouples J, K, and N	IEC 584-1
Thermocouples L	DIN 43710
Reference junction	Automatic cold junction compensation : 0 to 50 °C (Thermocouples)
Reference junction drift	0.1 °C / °C
Line resistance	100 Ω max
Calibration (IEC 584-1)	IEC 584 - 1
Resist. temp. detector Pt 100 according to IEC 751	3-wire
Line resistance	< 4 Ω
Input type and standard range TC	L (0/800°C) (0/999°F) / J (0/800°C) (0/999°F) K (0/999°C) (0/999°F) / N (0/999°C) (0/999°F)
Input types and standard range RTD Pt100	(-199/500°C) (-19.9/99.9°F) (-199/999°C)

#### Output

Type of output	discontinuous
Action type CTH 46 - CTD 43 - CTD 46	heating-cooling
Limitation of output power : SOFT-START- heat action	adjustable from 0 to 100 %
Limitation of output power : SOFT-START-heat/cool action	adjustable from -100 to + 100 %
Main output changeover relay	3 A 250 V AC resistive
Main output--logic	Max. load : 700 Ω Level 0 : < 0.5 V DC Level 1 : 14 V DC ± 20 % @ 20 mA max 24 V DC ± 20 % @ 1 mA max
Main output cycle time	1 s → 200 s
Cool output CTH 46 only	N/O-1 A contact, 250 V AC resistive
Alarm output CTD 43-CTD 46 only	N/O-1 A contact, 250 V AC resistive

### Control characteristics

Control algorithm	PID with auto-tune and adaptive tune : SMART
Control type CTD 43 CTD 46	heating or cooling
Control type CTH 46	heating-cooling
Sampling time	500 ms
Proportional band Pb CTD 43 - CTD 46	1.0 % to 99.9 % of scale amplitude
Proportional band Pb CTH 46	1.5 % to 99.9 % of scale amplitude
Proportional band Pb. Note : if Pb = 0 % discrete action	•
Hysteresis (during discrete action)	0.1 % to 10 % of scale amplitude
Integral time ti	1 min 20 s to 20 min 0 s (10 s resolution)
Derivative time td. Note : if td=0	1 s to 9 min 59 s
Cycle time heating	1 s → 200 s
Cycle time cooling (CTH46 only)	1 s → 200 s
Heat-cool control CTH 46 : Cool proportional band	rC x heat proportional band
Heat-cool control : rC : relative gain	0.20 → 1.00
Heat-cool control CTH 46 : dead.overlap band	-20 % to + 50 % of the heat proportional band

### Alarms (on CTD 43 and CTD 46 only)

Type of output	direct or reverse
Functions	absolute alarm, band alarm, deviation alarm
Reset to zero	manual
Inhibition	can be configured
Alarm threshold - absolute alarm	absolute value independent from SP
Alarm threshold - band alarm	value relative to SP, adjustable from 0 to 500 °C/°F
Alarm threshold - deviation alarm	value relative to SP, adjustable from -199°C/°F (negative deviation) to +500°C/°F (positive deviation)
Alarm	0.1 to 10 % of scale amplitude

## Dimensions

CTH / CTD

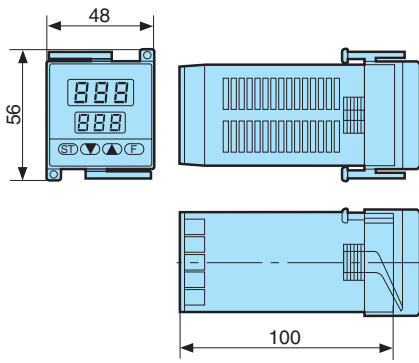

Panel cut-out

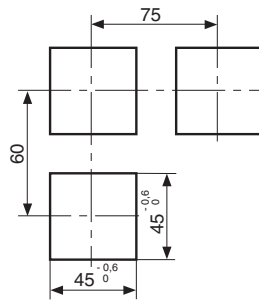

# Temperature controller/indicator CTD 24

## → CTD 24

- Concentrated technology and power, using the minimum of space.
- The Smart function ensures precision auto-tuning of the CTD24



### Specifications

Type	Output 1	Output 2	Supply	Code
CTD 24	relay 3 A-250 V resistive load	relay 3 A-250 V resistive load	100-240 AC	89 422 708
		logic 14 V-20 mA	24 AC-DC	89 422 702
	logic 14 V-20 mA	logic 14 V-20 mA	100-240 AC	89 422 718
		logic 14 V-20 mA	24 AC-DC	89 422 712
			100-240 AC	89 422 728
			24 AC-DC	89 422 722

### General characteristics

Display	4 digits
Universal input (configurable) Thermocouples	J (-100.0/999.9 °C) (-150/1830 °F) K (-100/1370 °C) (-150/2500 °F) R (-50/1760 °C) (-60/3200 °F) S (-50/1760 °C) (-60/3200 °F) T (-199.9/400 °C) (-330/750 °F) L (-100.0/900.0 °C) (-150/1650 °F) N (-100/1400 °C) (-150/2550 °F)
Universal input (configurable) Pt 100	2 and 3-wire (-199.9/850.0°C) (-330/1560 °F)
Universal input (configurable) Linear	0-60 mV, 12-60 mV
Dimensions	24 x 48 x 102 mm
Control	PID algorithm Auto-tune using SMART function Inverse and/or direct action Soft start function for preheating
Alarms	Configurable Control loop monitoring
2 Reference points	Selected with the ramp function between them
Connection	Removable screw terminal block
Weight (g)	90
Degree of protection of front panel	IP 65 - Nema 4X

### Dimensions

#### Outline and cut out dimensions

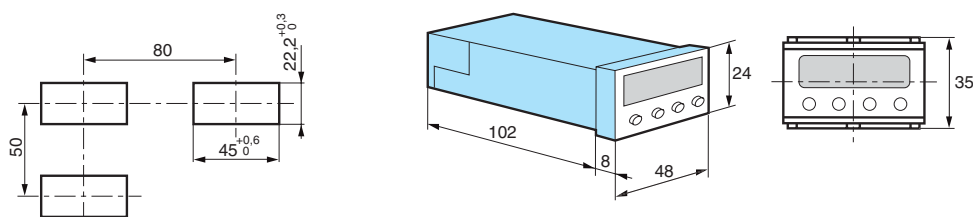

To order, see page 6

For more information [www.crouzet.com](http://www.crouzet.com)

# Temperature probes

## → Temperature probes

- Thermocouple J :
  - Nickel-plated brass eyelet
  - Stainless steel casing
  - Stainless steel sheath
- Thermocouple K
- PT 100 Class B :
  - Stainless steel sheath
  - Aluminium vee
- Connection / Sub-base / Flange



### Specifications

Type	Designation	Temperature	Characteristics	Code
Thermocouple / PT100	Thermocouple probe J	max : 400 °C	Thermocouple probe J with nickel-plated brass eyelet Ø 6.5 mm, connection sleeve Ø 5 x 30 mm in stainless steel 316 L. Glass filament cable with stainless steel braid : 2 m long Hot junction isolated from earth	79 696 030
		max : 600 °C	Thermocouple probe J with casing St. steel 304 L Ø 3 mm : 500 mm long PVC cable : 2 m long Junction cannot be removed Junction isolated from earth	79 696 031
		max : 400 °C	Thermocouple probe J with sheath St. steel 16 L Ø 6 mm : 200 mm long Glass filament cable with stainless steel braid : 2 m long Junction isolated from earth	79 696 032
	Thermocouple probe J with sheath		ST steel 316 L Ø 5 mm : 30 mm long Glass filament cable with stainless steel braid : 2 m long Junction isolated from earth	79 696 033
	Thermocouple probe K	max : 1100 °C	Thermocouple probe K with casing St. steel 304 L Ø 3 mm : 500 mm long PVC cable : 2 m long Junction isolated from earth	79 696 034
PT100 probe Class B	PT100 probe Class B	max : 200 °C	PT100 probe Class B with sheath St. steel 316 L Ø 6 mm : 200 mm long Silicon teflon cable : 2 m long 3-wire assembly	79 696 035
		max : 400 °C	PT100 probe Class B with sheath St. steel 316 L Ø 6 mm : 30 mm long Glass filament cable with stainless steel braid : 2 m long 2-wire assembly	79 696 036
		max : 200 °C	PT100 probe Class B Aluminium vee : 50 mm long Silicom teflon cable : 2 m long 3-wire assembly Supplied with fixing clamp	79 696 037

### Accessories

	Characteristics	Code
Connection	Sliding connection 1/4 " BSP CYL. St. steel 316 L Ø 3 mm	79 696 038
	Sliding connection 1/4 " BSP CYL. St. steel 316 L Ø 6 mm	79 696 039
	Sliding connection 1/2 " BSP CYL. St. steel 316 L Ø 6 mm	79 696 040
Sub-base	Sliding connection 1/4 " BSP CYL Ø 12 mm Nickel-plated steel	79 696 041
Flange	Galvanised steel flange Ø 6 mm	79 696 042

To order, see page 6

## Dimensions

Connection : 79 696 038

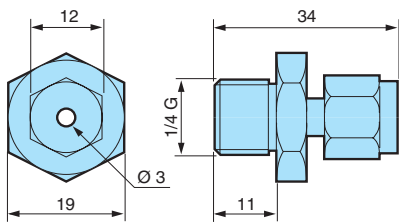

Sub-base : 79 696 041

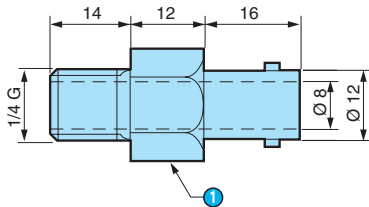

1 17 across flat

Connection : 79 696 039

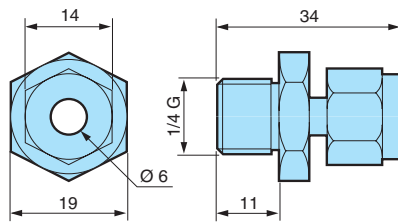

Flange : 79 696 042

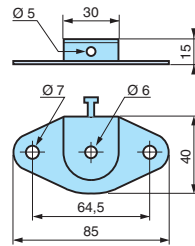

Connection : 79 696 040

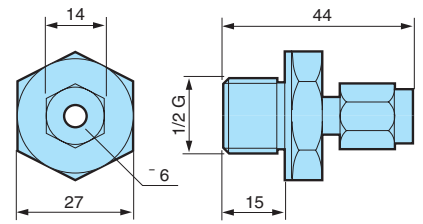

Thermocouple probe J : 79 696 030

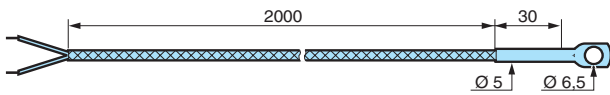

Thermocouple probe J : 79 696 031

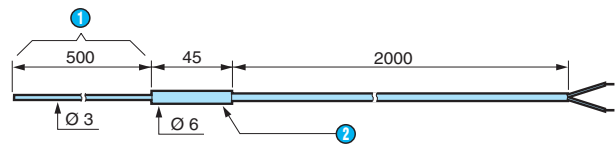

- 1 Flexible
- 2 Stainless steel sleeve

Thermocouple probe J : 79 696 032

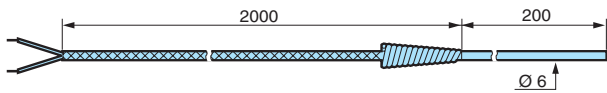

Thermocouple probe J : 79 696 033

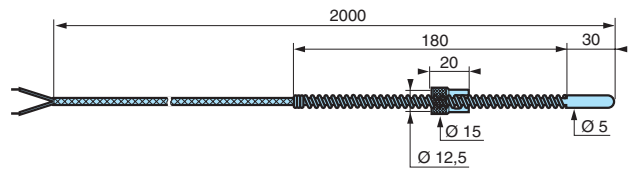

Thermocouple probe K : 79 696 034

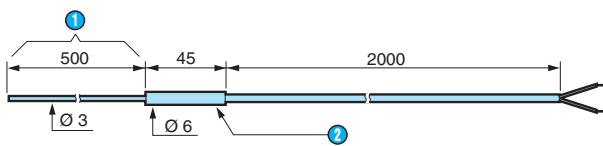

- 1 Flexible
- 2 Stainless steel sleeve

PT100 probe Class B : 79 696 035

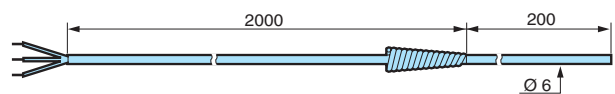

PT100 probe Class B : 79 696 036

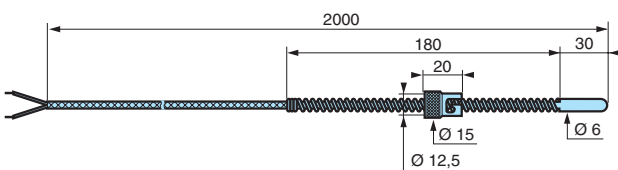

PT100 probe Class B : 79 696 037

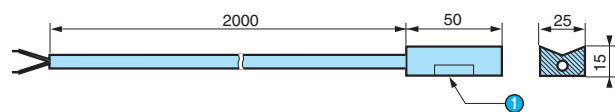

- 1 Aluminium vee



# Counters and Ratemeters

Counters and Ratemeters

002586



OUT 2



ON  
OFF



Function	Dimensions (mm)	Display	Max. counting speed	Counter input	Supply voltage	Manual reset	Designation	Timing range				
Counters and impulse counters	24 x 48	5 digits	-	-	24 V DC	Yes	Electro-mechanical counter 24 x 48 mm	-				
			50 to 60 Hz		24 V AC							
			6 digits		-				115 V AC			
					50 to 60 Hz				230 V AC			
		6 digits	50 to 60 Hz			24 V DC			No	24 V AC		
					115 V AC							
					230 V AC							
					230 V AC							
		LCD 8 digits	100 Hz		Volt-free or Solid state contact	Yes			Lithium battery	CP2 2293	-	Page 250
					Voltage					CP2 2294	-	Page 240
			7 KHz		Volt-free contact. Solid state or Voltage					CP2 2108	-	Page 246
					Solid state					CP2 2231	-	Page 246
	7.5 KHz	7.5 KHz	Voltage	CP2 2232	-	Page 246						
	28 x 53	LCD 8 digits	7.5 KHz	Volt-free contact	Lithium battery	No	C108 sealed version	-	Page 256			
							108	-	Page 258			
						Yes		-				
								-				
	36 x 37	5 digits	50 to 60 Hz	-	-	24 V DC	Yes	Electro-mechanical counter 36 x 37 mm	-			
						24 V AC						
115 V AC												
230 V AC												
6 digits		50 to 60 Hz	24 V DC			No	24 V AC					
			115 V AC									
			230 V AC									
			230 V AC									
36 x 48	5 digits	50 to 60 Hz	-	-	24 V DC	Yes	Electro-mechanical counter 36 x 48 mm	-				
					24 V AC							
					115 V AC							
					230 V AC							
	6 digits	50 to 60 Hz			24 V DC	No			24 V AC			
					115 V AC							
					230 V AC							
					230 V AC							
36 x 72	LCD 8 digits	5 KHz	Volt-free contact. Solid state or Voltage	Lithium battery	Yes	3233	-	Page 254				



Electromechanical counter  
24 x 48 mm



CP2



108

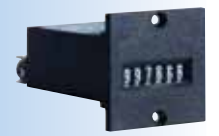





Electromechanical counter  
36 x 37 mm



Electromechanical counter  
36 x 48 mm

WITHOUT PRESELECTION



	Function	Dimensions (mm)	Display	Max. counting speed	Counter input	Supply voltage	Manual reset	Designation	Timing range			
WITHOUT PRESELECTION	Hour counter/Chronometer	24 x 48	LCD 6 digits	7 KHz	Volt-free contact	Lithium battery	Yes	CP2 2108H	Second Minute Hour	Page 240		
	Hour counters	24 x 48	LCD 6 digits	-	Volt-free contact or Solid state	Lithium battery	Yes	CP2 2213	Second Minute Hour	Page 242	CP2	
					Voltage			CP2 2214				
		48 x 48	5 digits	50 Hz	Voltage	18 to 26 V AC 36 to 48 V AC 110 to 127 V AC 220 to 240 V AC 24 to 30 V AC	No	CH 48 G	Hour	Page 266		CH 48 G
			60 Hz	110 to 127 V AC 220 to 240 V AC								
	Hour totalizer module	28 x 53	LCD 8 digits	7.5 KHz	Volt-free contact	Lithium battery	No	C108 sealed version	Hour	Page 256		3293
								108				
108 E												
108 R												
						Yes	108 ER		Page 258			
Totalizer and ratemeter	36 x 72	LCD 8 digits	5 KHz	Volt-free contact. Solid state or Voltage	Lithium battery	Yes	3293	-	Page 254			
Tachometer	36 x 72	LCD 6 digits	5 KHz	Volt-free contact. Solid state or Voltage	Lithium battery	Yes	3253	-	Page 254			

Function	Number of presets		Counting input modes										Dimensions (mm)	Display	Max. counting speed (KHz)	Output	Supply voltage	Designation
			UP	DN	CUMUL	DIR	IND	PH	PH2	PH4	BATCH	Upcounting						

Upcounter Downcounter	1	x	x												48 x 48	LCD 5 digits	5	1 changeover	10 to 30 VDC 20 to 55 VAC 80 to 260 VAC	CP4 4141	Page 232	 CP4 4141	
																		1 contact and 1 solid state	10 to 30 VDC 20 to 55 VAC 80 to 260 VAC				
	1	x	x													48 x 48	LCD red 5 digits	5	1 changeover	10 to 30 VDC 20 to 55 VAC 80 to 260 VAC	CP4 4341	Page 233	
																			1 contact and 1 solid state	10 to 30 VDC 20 to 55 VAC 80 to 260 VAC			
	1	x	x	x	x	x	x	x	x	x	x					72 x 72	LCD 6 digits	5	1 contact and 1 solid state	10 to 30 VDC 20 to 55 VAC 80 to 260 VAC	CP7 7141	Page 236	 CP7 7141
	2	x	x													48 x 48	LCD 5 digits	5	2 contact	10 to 30 VDC 20 to 55 VAC 80 to 260 VAC	CP4 4142	Page 232	
																				2 solid state			10 to 30 VDC 20 to 55 VAC 80 to 260 VAC
2			x	x	x	x									48 x 48	LCD 5 digits	5	2 contact	10 to 30 VDC 20 to 55 VAC 80 to 260 VAC	CP4 4144	Page 232		
																			2 solid state			10 to 30 VDC 20 to 55 VAC 80 to 260 VAC	
2	x	x													48 x 48	LCD red 5 digits	5	2 contact	10 to 30 VDC 20 to 55 VAC 80 to 260 VAC	CP4 4342	Page 233	 CP4 4342	
																			2 solid state				10 to 30 VDC 20 to 55 VAC 80 to 260 VAC
2			x	x	x	x									48 x 48	LCD red 5 digits	5	2 contact	10 to 30 VDC 20 to 55 VAC 80 to 260 VAC	CP4 4344	Page 233		
																			2 solid state			10 to 30 VDC 20 to 55 VAC 80 to 260 VAC	
2	x	x	x	x	x	x	x	x	x						72 x 72	LCD 6 digits	5	2 changeover and 2 solid state	10 to 30 VDC 20 to 55 VAC 80 to 260 VAC	CP7 7142	Page 236	 CP7 7142	

Function	Counting input modes										Dimensions (mm)	Display	Max. counting speed (KHz)	Output	Supply voltage	Designation		
	Number of presets		UP	DN	CUMUL	DIR	IND	PH	PH2	PH4							BATCH	
<b>WITH PRESELECTION</b>  Upcounter Downcounter Batch counter Chronometer Tachometer	2	x	x	x	x	x	x	x	x	x	x	48 x 48	LCD 5 digits	7.5	2 contact	10 to 30 VDC	CP4 4192	Page 232
																20 to 55 VAC		
	2	x	x	x	x	x	x	x	x	x	x	48 x 48	LCD red 5 digits	7.5	2 solid state	10 to 30 VDC	CP4 4392	Page 233
																20 to 55 VAC		
	2	x	x	x	x	x	x	x	x	x	x	72 x 72	LCD 6 digits	7.5	2 changeover and 2 solid state	10 to 30 VDC	CP7 7192	Page 236
													20 to 55 VAC					
	2	x	x	x	x	x	x	x	x	x	x	72 x 72	LCD red 6 digits	7.5	2 changeover and 2 solid state	10 to 30 VDC	CP7 7392	Page 237
													20 to 55 VAC					
																80 to 260 VAC		
																10 to 30 VDC		
																20 to 55 VAC		
																80 to 260 VAC		



CP4 4192



CP7 7392

**Reminder of input counting modes:**

- UP . . . . . Upcounting
- DN . . . . . Downcounting
- CUMUL . . . . . Cumulative counting
- DIR . . . . . Directional up-down counting
- IND . . . . . Independent up-down counting
- PH . . . . . Encoder phase shift
- PH2 . . . . . Encoder phase shift X2
- PH4 . . . . . Encoder phase shift X4
- BATCH . . . . . Batch counting

# Our range of counters will handle a vast variety of applications

## Preselection down counters

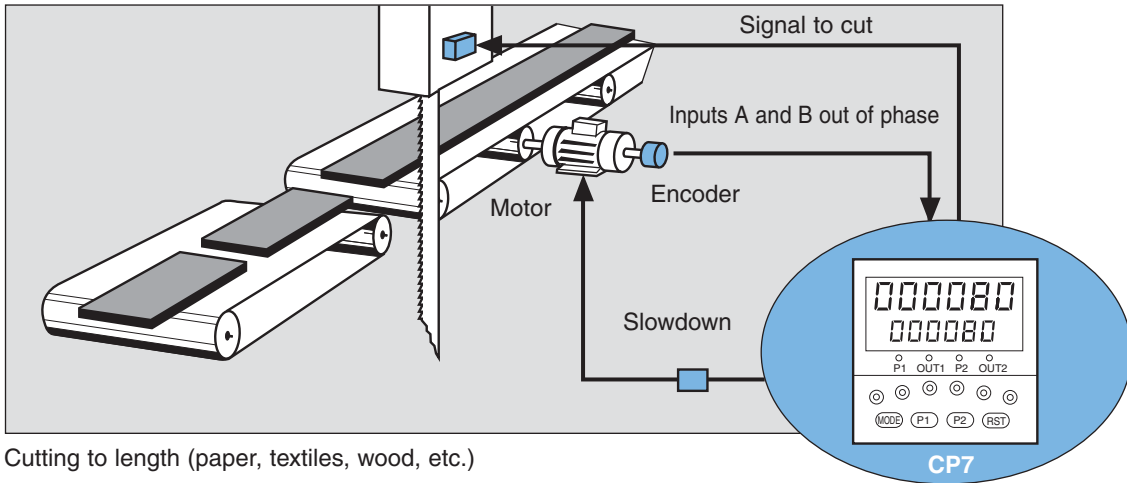

Cutting to length (paper, textiles, wood, etc.)

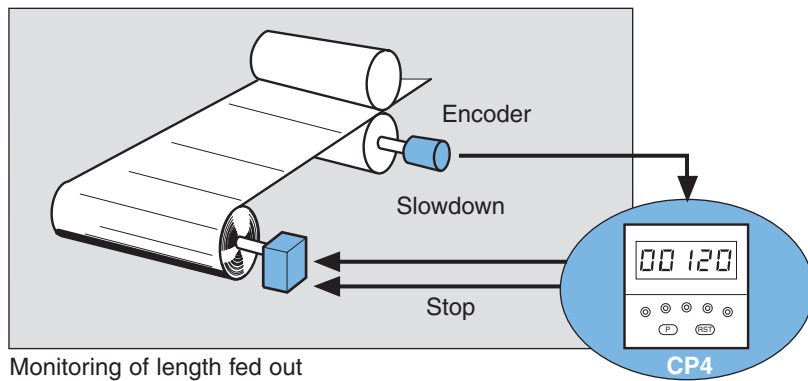

Monitoring of length fed out

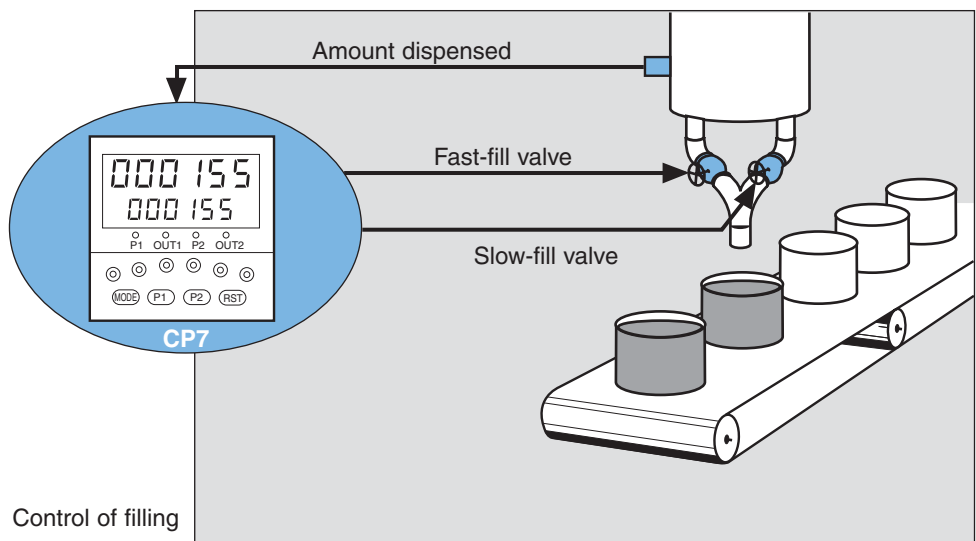

Control of filling

# Impulse / hour totalizers

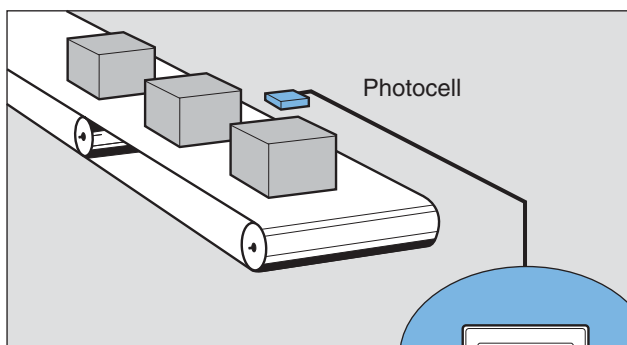

Counting parts

CP2 / 2231

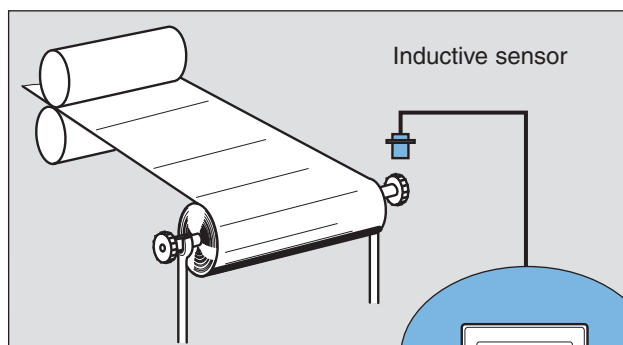

Readout of length drawn off

2293

# Tachometers

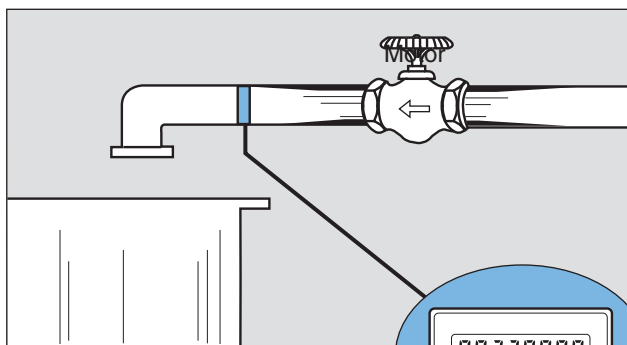

Readout of flow rate

3293

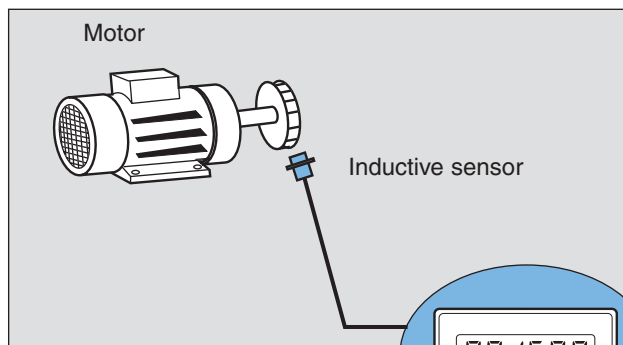

Readout of speed

3253

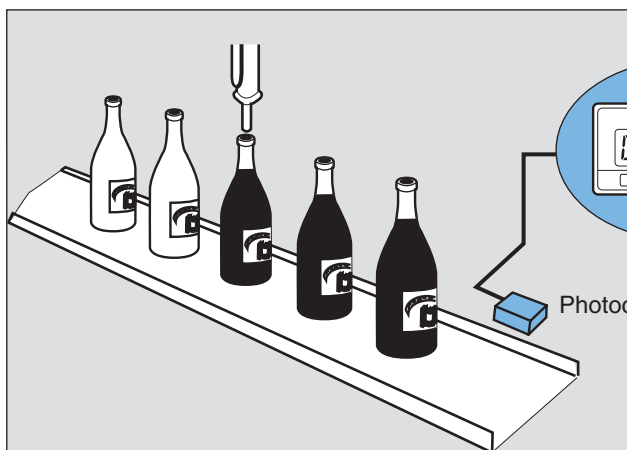

Readout of number of bottles or output rate of filling line

3293

# Basic principles of tachometers

## General

Tachometers can be used to measure speeds (of linear or rotary movement), rates (per minute or per hour), or rates of flow (volumetric, etc.).

Pulses are fed to the tachometer at the frequency to be measured. A scale factor is applied to produce readings of the desired type (linear speeds, flow rates, etc.).

Crouzet/Syrelec tachometers operate on 2 different principles :

- 1 - The fixed time base principle, and
- 2 - The reciprocal principle

### 1 - Principle of the fixed time base tachometer

The tachometer totals the number of pulses received during a fixed period of time known as the time base. At the end of this period, a value for the frequency measured is shown on the display.

The time base can be set at the time of installation. It is calculated from the formula shown below, where :

- B : is the time base being calculated,
- $N_d$  : is the number of pulses per revolution,
- $N_t$  : is the number of revolutions per minute, and
- V : is the value that will appear on the display.

The time base is given by :

$$B = \frac{V \times 60}{N_t \times N_d}$$

Once the time base has been calculated, it is set by means of DIP switches (or changeover switches) situated on the unit.

#### As an example:

Assume a sensor emits 8 pulses per revolution. What you want to see on the display is a speed in revs per minute. The maximum this speed can be is 2000 rpm.

- $N_d = 8$
- $N_t = 2000$
- $V = N_t$  (since what you want displayed is a speed in rpm).

$$B = \frac{2000 \times 60}{2000 \times 8} = 7,5 \text{ secondes}$$

Fixed time base tachometers are useful for high speeds but, if the accuracy obtained is to be good, it is essential for the number of pulses per revolution to be high.

To overcome this drawback, Crouzet Automation can supply reciprocal tachometers. These need only a single pulse per revolution and are able to measure both high and low speeds.

### 2 - Principle of the reciprocal tachometer

This tachometer measures the intervals between n count pulses (the period) and then performs the calculation

$$f = \frac{1}{T}$$

to obtain a frequency.

The parameters which govern this tachometer are the following :

- the sampling time ( $T_r$ )
- the time limit for measurement ( $T_L$ )

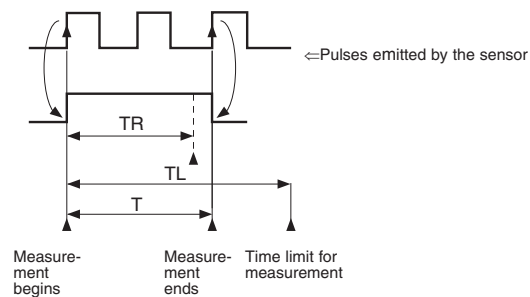

Measurement ends at the rising edge of the first pulse after  $T_r$ . If no pulse is received after  $T$ , the system waits until the time limit  $T_L$  and then shows zero on the display.

If the frequency of the signal is low, conditions are as shown below :

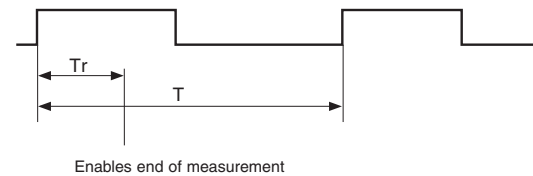

The interval between 2 rising edges is very much longer than  $T_r$ . The tachometer displays 0 until time  $T$ , at which it displays the new value.

# Preselection and multifunction up/down counters 48x48

- CP4 : back-lit LCD display
- CP4 Red illuminated display

Physical details and protection		Inputs specifications	
Immunity from micro power cuts	Version 10 to 30 V DC : 10 ms Version 20 to 55 V AC : 10 ms Version 80 to 260 V AC : 10 ms	2 counting inputs IN1, IN2	•
Relative humidity (no condensation)	95 %	Input modes	4142 - 4341
Altitude	0 - 2000 m	UP, DN, CUMUL, DIR, IND PHASE,	4142 - 4342
Insulation (IEC 664-1)	2.5 kΩ	PHASE x 2	4144 - 4344
Standards	Conforming to IEC 1000.4.2 : Level 3 Conforming to IEC 1000.4.3 : Level 3 Conforming to IEC 1000.4.4 : Level 3 Conforming to IEC 1000.4.6 : Level 3 Conforming to EN 55022/11 group 1 : Class A	PHASE x 4	4192 - 4392
Vibration resistance in 3 axes acc. to IEC 68-2-6	10 - 55 Hz / 0.35 mm	Input by contact, voltage or solid state device for 3-wire and 2-wire detection using external resistor (NPN or PNP if present)	•
Material	Self-extinguishing	Low level	0 → 1 V DC
Connection by screw terminals	•	High level	4 → 30 V DC
Tightening capacity	2 x 1.5 mm <sup>2</sup>	Impedance	10 KΩ
Mounting Front panel, by clip	•	Counting speed	
Front panel protection	IP 54	Counter	5 kHz or 30 Hz 2.5 kHz PH4
Front panel watertight seal	•	Counting speed - Multifunction	
Temperatures limits use (°C)	0 → +55	Counter UP, DOWN, DIR	7.5 kHz
Temperature limits stored (°C)	-25 → +70	Counter non simultaneous IND, CUMUL (IN1 & IN2 non simultaneous)	7.5 kHz
Weight (g)	200	Counter IND, CUMUL (IN1 & IN2 simultaneous)	4.0 kHz
Outputs solid state characteristics		Counter / Tachometer PH, PH2	5.0 kHz
Type NPN open collector	•	Counter / Tachometer PH, PH2 (except in Batch mode)	4.0 kHz
Maximum current	100 mA	Counter PH4	2.5 kHz
Maximum voltage	40 V DC	Tachometer UP, DOWN, DIR	9.0 kHz
Voltage drop	< 1.5 V	Tachometer IND, CUMUL (IN1 IN2 non simultaneous)	9.0 kHz
Response time	< 250 μs	Tachometer IND, CUMUL (IN1 IN2 simultaneous)	5.0 kHz
Response time	< 250 μs	Tachometer PH4	4.0 kHz
Outputs Relay characteristics		Reset	
Current rating	2 A	Reset to zero or to preset	From front panel : if not protected in programming phase Electrical : by contact, voltage or solid state device (NPN or PNP if present)
Maximum voltage	250 V AC	Minimum pulse time	5 ms
Max contact rating (resistive) - AC1	500 VA	Low level	0 → 1 V DC
Rated current	10 mA	High level	4 → 30 V DC
Response time	< 10 ms	Impedance	10 KΩ
Mechanical life (operations)	3 x 10 <sup>6</sup>	Option to protect against reset from front panel	•
Permitted number of operations at 2 A AC1	1 x 10 <sup>5</sup>	Scale factor (each input pulse is multiplied by this figure)	00.001 → 99.999
Output modes : maintained or pulsed	t = 0.1 s to 9.9 s for types 4192 and 4392 t = 500 ms for other types	Decimal point selectable for ease of reading	xxxxx, xxxxx.x, xxx.xx, xx.xxx,
Single shot or repetitive (immediate auto reset)	•	Sensor supply Version AC	12 V DC / 100 mA
Supply (min/max values)	10 → 30 V DC 20 → 55 V AC 80 → 260 V AC	Sensor supply Version DC	Un - 2 V / 100 mA
Maximum consumption - Version DC	4 W	Programming and current value backed up via EEPROM memory	•
Maximum consumption - Version AC	10 VA		
Operating characteristics			
Functions	Preselection up/down counter Multifunction : counters, "Batch" counters, tachometers and chronometers		
Number of presets	1 or 2		
Back-lit LCD or red illuminated display	Current value : 5 digits Preset : 5 digits		
Height of digits	Current value : 8 mm Preset : 4 mm		
Display details	-9999 - + 99 999		
Simultaneous readout of count value and preset	•		

# Preselection and multifunction up/down counters 48x48

## → CP4 : back-lit LCD display

- Presets and scale factor easy to alter
- Large back-lit LCD display or red illuminated display
- Simultaneous display of current value and preset
- Safeguarded : good resistance to interference
- Backed up on EEPROM memory
- Slide-out electronics for easy maintenance



### Specifications

Type	Time base	Counting input modes	Designation	Output	Voltages	Code
4141-1 preset	-	UP, DN, PH	Up/down counter	1 contact and 1 solid state	10 to 30 VDC	87 618 012
					20 to 55 VAC	87 618 014
					80 to 260 VAC	87 618 018
				1 changeover relay	10 to 30 VDC	87 618 042
					20 to 55 VAC	87 618 044
					80 to 260 VAC	87 618 048
4142-2 preset	-	UP, DN, PH	Up/down counters	2 solid states	10 to 30 V	87 618 062
					20 to 55 VAC	87 618 064
					80 to 260 VAC	87 618 068
				2 contacts	10 to 30 VDC	87 618 022
					20 to 55 VAC	87 618 024
					80 to 260 VAC	87 618 028
4144-2 preset	-	DIR, IND, CUMUL, PH	Up/down counters	2 solid states	10 to 30 VDC	87 618 072
					20 to 55 VAC	87 618 074
					80 to 260 VAC	87 618 078
				2 contacts	10 to 30 VDC	87 618 032
					20 to 55 VAC	87 618 034
					80 to 260 VAC	87 618 038
4192-2 preset	99h59min - 99min59s - 99.99s -24h	UP, DN, IND, CUMUL, DIR, PH, PH2, PH4	Multifunctions : Counters - "Batch" counters - tachometers and chronometers	NO, 2 solid states	10 to 30 VDC	87 618 262
					20 to 55 VDC	87 618 264
					80 to 260 VDC	87 618 268
				NO, 2 contacts	10 to 30 VDC	87 618 222
					20 to 55 VDC	87 618 224
					80 to 60 VDC	87 618 228

### Connections

87 618 042      87 618 142  
87 618 044      87 618 144  
87 618 048      87 618 148

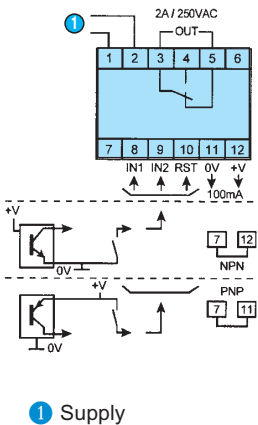

87 618 012      87 618 112  
87 618 014      87 618 114  
87 618 018      87 618 118

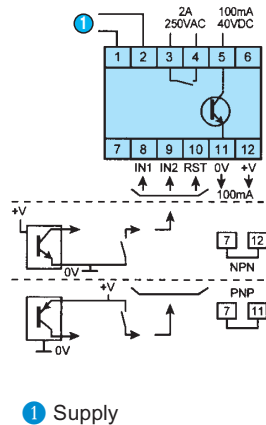

87 618 022      87 618 122  
87 618 024      87 618 124  
87 618 028      87 618 128

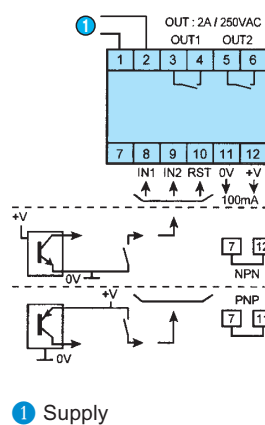

87 618 062      87 618 162  
87 618 064      87 618 164  
87 618 068      87 618 168

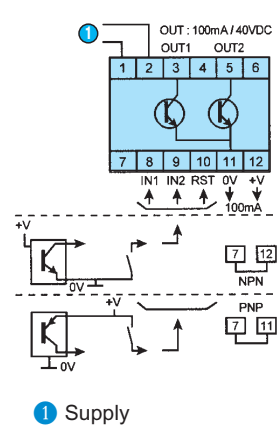



# Preselection and multifunction up/down counters 48x48

## → CP4 Red illuminated display

- Presets and scale factor easy to alter
- Large back-lit LCD display or red illuminated display
- Simultaneous display of current value and preset
- Safeguarded : good resistance to interference
- Backed up on EEPROM memory
- Slide-out electronics for easy maintenance



### Specifications

Type	Time base	Counting input modes	Designation	Output	Voltages	Code
4341-1 preset	-	UP, DN, PH	Up/down counter	NO, 1 contact and 1 solid state	10 to 30 VDC	87 618 112
					20 to 55 VAC	87 618 114
				1 changeover relay	10 to 30 VDC	87 618 142
					20 to 55 VAC	87 618 144
4342-2 preset	-	UP, DN, PH	Up/down counters	NO, 2 solid states	10 to 30 VDC	87 618 162
					20 to 55 VAC	87 618 164
				NO, 2 contacts	10 to 30 VDC	87 618 122
					20 to 55 VAC	87 618 124
4344-2 preset	-	DIR, IND, CUMUL, PH	Up/down counters	NO, 2 solid states	10 to 30 VDC	87 618 172
					20 to 55 VAC	87 618 174
				NO, 2 contacts	10 to 30 VDC	87 618 132
					20 to 55 VAC	87 618 134
4392-2 preset	99h59min - 99min59s - 99.99s - 24h	UP, DN, IND, CUMUL, DIR , PH, PH2, PH4	Multifunctions : Counters - "Batch" counters - Totalizers - Tachometers - Chronometers	NO, 2 solid states	10 to 30 VDC	87 618 362
					20 to 55 VAC	87 618 364
					80 to 260 VAC	87 618 368
					10 to 30 VDC	87 618 322
					20 to 55 VAC	87 618 324
					80 to 260 VAC	87 618 328

### Dimensions

#### CP4

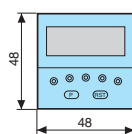
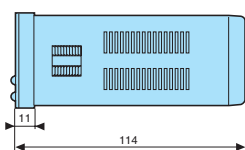

#### Panel cut-out

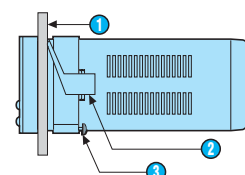
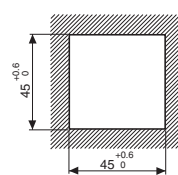

- 1 Panel thickness 1 to 10 mm
- 2 Fixing clip
- 3 Positioning screw

To order, see page 6. Curves : see page 238

For more information [www.crouzet.com](http://www.crouzet.com)



# Preselection and Multifunction up/down counters 72x72

→ CP7 : Back lit display

→ CP7 : red illuminated display

Physical details and protection	
Immunity from micro power cuts	Version 10 to 30 V DC : 10 ms Version 20 to 55 V AC : 10 ms Version 80 to 260 V AC : 10 ms
Relative humidity (no condensation)	95 %
Altitude	0 - 2000 m
Insulation (IEC-664-1)	2.5 kV
Standards	Conforming to IEC 1000.4.2 : Level 3 Conforming to IEC 1000.4.3 : Level 3 Conforming to IEC 1000.4.4 : Level 3 Conforming to IEC 1000.4.6 : Level 3 Conforming to EN 55022/11 group 1 : Class A
Vibration resistance in 3 axes acc. to IEC 68-2-6	10 - 55 Hz / 0.35 mm
Material	Self-extinguishing
Connection by screw terminals	•
Terminal capacity	2 x 1.5 mm <sup>2</sup>
Mounting Front panel, by clip	•
Front panel protection	IP 54
Front panel watertight seal	•
Temperatures limits use (°C)	0 → +55
Temperature limits stored (°C)	-25 → +70
Weight (g)	290
Outputs solid state characteristics	
Type NPN open collector	•
Maximum current	100 mA
Maximum voltage	40 V DC
Voltage drop	< 1.5 V
Response time	< 250 µs
Relay output characteristics	
1 or 2 changeover relays	•
Current rating	2 A
Maximum voltage	250 V AC
Max contact rating (resistive) - AC1	500 VA
Rated current	100 mA
Response time	< 10 ms
Mechanical life (operations)	3 x 10 <sup>7</sup>
Electrical life under I max. resistive AC 1	1 x 10 <sup>5</sup>
Output modes : maintained or pulsed (fixed pulse duration)	t = 0.9 s to 9.9 s for types 7192 and 7392 t = 500 ms for other types
Single shot or repetitive (immediate auto reset)	•
Supply (min/max values)	10 → 30 V DC 20 → 55 V AC 80 → 260 V AC
Maximum consumption - Version DC	< 5 W
Maximum consumption - Version AC	< 13 VA
Operating characteristics	
Functions	Preselection up/down counter Multifunction : counters, "Batch" counters, tachometers and chronometers
Number of presets	1 or 2
Back-lit LCD or red illuminated display	Current value : 6 digits Preset : 6 digits
Height of digits	Current value : 10 mm Preset : 6 mm
Display details	-9999 - + 99 999

Inputs specifications	
2 counting inputs IN1, IN2	•
1 inhibit input	•
Input modes	•
UP, DN, CUMUL, DIR, IND PHASE, PHASE x 2	
PHASE x 4	
Contact, voltage or solid state (NPN/PNP by changeover switch)	•
Low level	0 → 1 V DC
High level	4 → 30 V DC
Impedance	10 kΩ
Counting speed	
Counter	5 kHz (2.5 kHz in phase 4) 30 Hz in debounce mode
Counting speed - Multifunction	
Counter UP, DOWN, DIR	7.5 kHz
Counter non simultaneous IND, CUMUL (IN1 & IN2 non simultaneous)	7.5 kHz
Counter IND, CUMUL (IN1 & IN2 simultaneous)	4.0 kHz
Counter / Tachometer PH, PH2	5.0 kHz
Counter /Tachometer PH, PH2 (except in Batch mode)	4.0 kHz
Counter PH4	2.5 kHz
Tachometer UP, DOWN, DIR	9.0 kHz
Tachometer IND, CUMUL (IN1 IN2 non simultaneous)	9.0 kHz
Tachometer IND, CUMUL (IN1 IN2 simultaneous)	5.0 kHz
Tachometer PH4	4.0 kHz
Totalizer UP, DOWN, DIR	6.0 kHz
Totalizer IND, CUMUL (IN1 & IN2 non simultaneous)	6.0 kHz
Totalizer IND, CUMUL (IN1 & IN2 simultaneous)	3.0 kHz
Totalizer PH, PH2	3.5 kHz
Totalizer PH4	1.5 kHz
Reset	
Reset to zero or to preset	From front panel : if not protected in programming phase Electrical : by contact, voltage or solid state device (NPN or PNP if present)
Minimum pulse time	5 ms
Low level	0 → 1 V DC
High level	4 → 30 V DC
Impedance	10 kΩ
Option to protect against reset from front panel	•
Scale factor (each input pulse is multiplied by this figure)	00.0001 → 99.9999
Decimal point selectable for ease of reading	xxxxxx, xxxxx.x, xxxx.xx, xxx.xxx, xx.xxxx
Sensor supply Version AC	12 V DC / 100 mA
Sensor supply Version DC	Un - 2V / 100 mA
Programming and current value backed up via EEPROM memory	•

# Preselection and Multifunction up/down counters 72x72

## → CP7 : Back lit display

- Presets and scale factor easy to alter
- Large back-lit LCD display or red illuminated display
- Simultaneous display of current value and preset
- Safeguarded : good resistance to interference
- Backed up on EEPROM memory
- Slide-out electronics for easy maintenance



### Specifications

Type	Time base	Counting input modes	Designation	Output	Voltages	Code
7141- 1 preset	-	UP, DN, IND, CUMUL, DIR, PH, PH2, PH4	Up/down counters	1 changeover realy + 1 solid state relay	10 to 30 VDC 20 to 55 VAC 80 to 260 VAC	<b>87 619 012</b> <b>87 619 014</b> <b>87 619 018</b>
7142-2 preset	-	UP, DN, IND, CUMUL, DIR, PH, PH2, PH4	Up/down counters	2 changeover relays + 2 solid states	10 to 30 VDC 20 to 55 VAC 80 to 260 VAC	<b>87 619 022</b> <b>87 619 024</b> <b>87 619 028</b>
7192-2 preset	99h59min - 99min59s - 99.99s - 24h - 999.99h - 999.99min	UP, DN, IND, CUMUL, DIR, PH, PH2, PH4	Multifunctions : Counters - "Batch" counters - Tachometers and chronometers - Totalizers	2 changeover relays + 2 solid states	10 to 30 VDC 20 to 55 VAC 80 to 260 VAC	<b>87 619 222</b> <b>87 619 224</b> <b>87 619 228</b>

### Connections

87 619 012  
87 619 014  
87 619 018

87 619 112  
87 619 114  
87 619 118

87 619 022  
87 619 024  
87 619 028

87 619 122  
87 619 124  
87 619 128

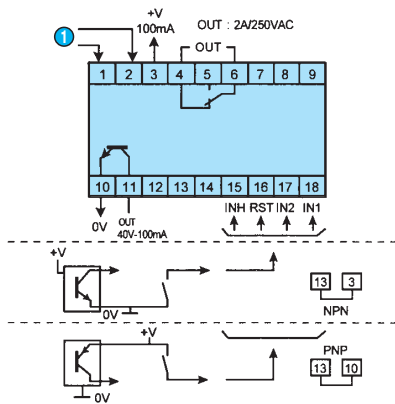

1 Supply

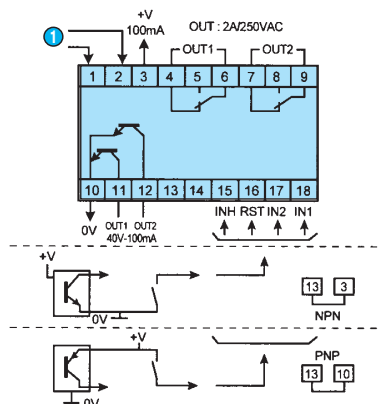

1 Supply

# Preselection and Multifunction up/down counters 72x72

## → CP7 : red illuminated display

- Presets and scale factor easy to alter
- Large back-lit LCD display or red illuminated display
- Simultaneous display of current value and preset
- Safeguarded : good resistance to interference
- Backed up on EEPROM memory
- Slide-out electronics for easy maintenance



### Specifications

Type	Time base	Counting input modes	Designation	Output	Voltages	Code
7341-1 preset	-	UP, DN, IND, CUMUL, DIR, PH, PH2, PH4	Up/down counter	1 changeover relay + 1 solid state	10 to 30 VDC	<b>87 619 112</b>
					20 to 55 VAC	<b>87 619 114</b>
					80 to 260 VAC	<b>87 619 118</b>
7342-2 preset	-	UP, DN, IND, CUMUL, DIR, PH, PH2, PH4	Up/down counter	2 changeover relays + 2 solid states	10 to 30 VDC	<b>87 619 122</b>
					20 to 55 VAC	<b>87 619 124</b>
					80 to 55 VAC	<b>87 619 128</b>
7392-2 preset	99h59min - 99min59s - 99.99s - 24h - 999.99h - 999.99 min	UP, DN, IND, CUMUL, DIR, PH, PH2, PH4	Multifunctions : Counters - "Batch" counters - Totalizers - Tachometers - Chronometers	2 changeover relays + 2 solid states	10 to 30 VDC	<b>87 619 322</b>
					20 to 55 VAC	<b>87 619 324</b>
					80 to 260 VAC	<b>87 619 328</b>

### Dimensions

#### CP7

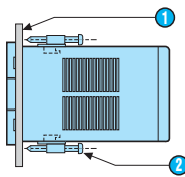
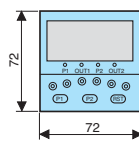
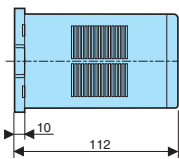

- 1 Panel thickness
- 2 Screw

#### Panel cut-out

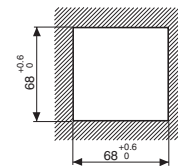

# Preselection and multifunction counters CP4 - CP7

## Input modes

**Input modes**

PNP Count on rising edge  
NPN Count on falling edge

---

**UP**

- Input IN1
- Display

① ②

---

**DN**

- Input IN1
- Display

① ②

---

**IND**

- Input IN1 count in the direction of the cycle
- Input IN2 count in the opposite direction from the cycle
- Display (0 → P)
- Display (P → 0)

① ② ③ ④

---

**CUMUL**

- Input IN1 count in the direction of the cycle
- Input IN2 count in the direction of the cycle
- Display (0 → P)
- Display (P → 0)

① ② ③ ④

---

**DIR**

- Input IN1 pulses
- Input IN2 count in the opposite direction from the cycle
- Display (0 → P)
- Display (P → 0)

① ② ③ ④

---

**PH**

- Input IN1
- Input IN2
- Display (0 → P)
- Display (P → 0)

① ② ③ ④

---

**PH 2**

- Input IN1, counts on rising and falling edges
- Input IN2, direction of count reversed if IN2 in advance of IN1
- Display (0 → P)
- Display (P → 0)

① ② ③ ④

---

**PH 4**

- Input IN1, counts on rising and falling edges
- Input IN2, counts on rising and falling edges, direction of count reversed if IN2 in advance of IN1
- Display (0 → P)
- Display (P → 0)

① ② ③ ④

## Output modes

Count in the direction of the cycle → ← Count in the opposite direction from the cycle

→ **Single shot** *PR nU*

**1 Preset**

PR → 0 P ..... 1 0 -1 -2 ..... -1 0 1 .....  
0 → PR 0 | ..... P-1 P P+1 P+2 ..... P+1 P P-1 .....

**OUT** ON OFF

or **OUT 2**

**2 Presets**

PR → 0 P2 ..... P1+1 P1 P1-1 P1-2 ..... P1-1 P1 P1+1 .....  
0 → PR 0 | ..... P1-1 P1 P1+1 P1+2 ..... P1+1 P1 P1-1 .....

**OUT 1** ON OFF

---

Maintained

**1 Preset**

PR → 0 ..... 1 0 -1 -2 ..... -1 0 1 2 3 .....  
0 → PR 0 | ..... P-1 P P+1 P+2 P+1 P P-1 P-2 .....

**OUT 2** ON OFF

**2 Presets**

PR → 0 P2 ..... P1+1 P1 P1-1 P1-2 ..... P1 P1+1 P1+2 .....  
0 → PR 0 | ..... P1-1 P1 P1+1 P1+2 ..... P1+1 P1 P1-1 .....

**OUT 1** ON OFF

---

Pulsed (transient pulse) (t = 500 ms) t = 0.1s to 9.9s for multifunction

→ **Repetitive cycle** *PR nU*

Pulsed with auto reset to value of P2 (or P for 1 preset) (t = 500 ms) t = 0.1s to 9.9s for multifunction

PR → 0 P2 | P2-1 ..... 1 P2 P2-1 ..... n n+1 ..... P2 P2+1  
0 → PR 0 | ..... P2-1 0 1 ..... n n-1 ..... 0 1 -1

**OUT 2** ON OFF

## Batch counter function

→ **Principle**

P1 is the "batch" preset.

When P2 is displayed, the value displayed on the upper digits represents the current counter value (reset to P2). In this configuration the "RST" key on the front panel reinitialises the current value.

When P1 (batch preset) is displayed, the value displayed on the upper digits represents the value of the Batch counter.

In this configuration the "RST" key on the front panel resets the batch counter. An "electrical" reset (RST terminal) still resets the current counter value and that of the batch counter

→ **Example**

On a packing line, bottles need to be counted into packs of 6 bottles and then dispatched in a box containing a batch of 4 packs.

P2 : current counter preset value : 00006  
P1 : batch counter preset value : 00004

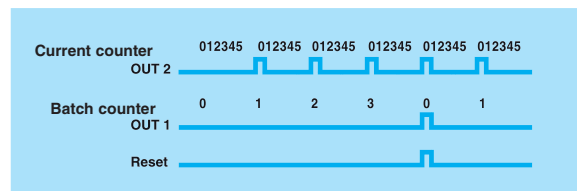

## Totalizer function

- On multifunction CP7
- Totalizer reset via front panel only
  - Current value reset via front panel and electrical.

# Multifunction counters CP4 - CP7

## Tachometer function

### → Measurement principle

Measurement begins on a rising edge of the signal to be measured. The measurement time is greater than TR, but less than TL. Measurement stops at the end of the current period (3), after TR. If the period (3) does not end before TL, the measurement result will be zero (0).

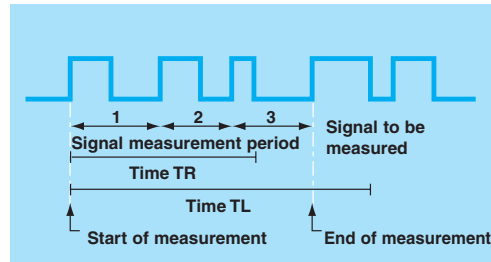

Measurement precision :  $100 + (200 / TR)$  PPM  
 Example : for TR = 1s → 300 PPM (0.03%)

The outputs are updated each time measurement ends according to the selected output mode.

- **Maintained output** : output active if the measured speed is greater than the preset speed.
- **Pulsed output** : output activated during time T, when the preset threshold is crossed.

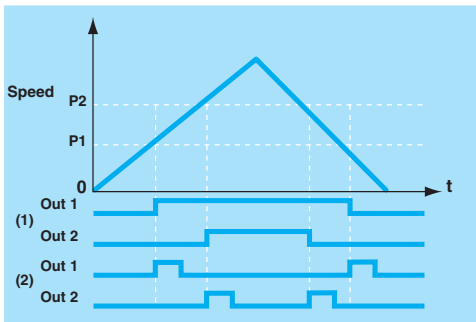

(1) Maintained output (2) Pulsed output

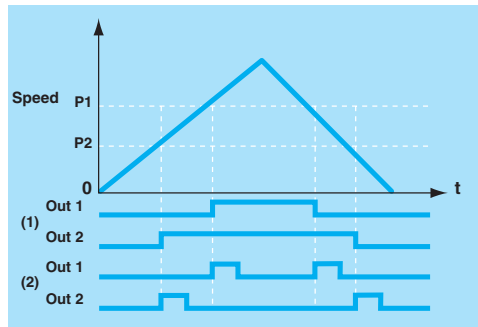

### → Application example

You wish to display a linear speed of 2.00 m/s for a drive pulley rotating at 300 rpm. A sensor on this pulley delivers one pulse per revolution, ie:

$$V = \frac{N_s \cdot \text{Coef} \cdot \text{RPX}}{n}$$

Required display:  $V = 2.00$  (result in m/s → RPX = 1)

Given that:  $n = 1$

$$N_s = \frac{300}{60} = 5$$

$$\text{Hence Coef} = \frac{V \cdot n}{N_s \cdot \text{RPX}} \rightarrow \text{Coef} = \frac{200 \cdot 1}{5 \cdot 1} = 40$$

In addition, the decimal point is positioned in the hundreds (xxxx.xx). Selection of TR : you wish the measurement to be updated every 2 seconds if TR = 2s. Selection of TL > TR, for example TL = 3s.

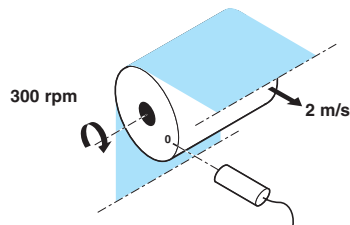

The tachometer function can also be used to calculate a flow rate.

## Chronometer function (Precision : 150 ppm)



- 1 Input IN1
- 2 Display (0 → PR), 1-channel pulse measurement
- 3 Display (PR → 0), 1-channel pulse measurement

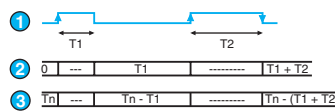

- 1 Input IN1
- 2 Display (0 → PR), 1-channel pulse measurement
- 3 Display (PR → 0), 1-channel pulse measurement

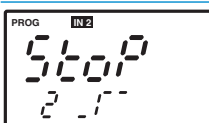
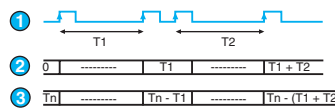

- 1 Input IN1 (start counting)
- 2 Input IN2 (stop counting)
- 3 Display (0 → PR), measurement on 2 separate channels
- 4 Display (PR → 0), measurement on 2 separate channels

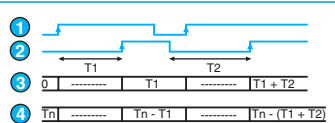

# Totalizers - LCD 24 x 48 (Hour counter/chronometer)

## → CP2 : 2108/2108H

- 8 or 6-figure display, height 7 mm
- Totalizer :
  - 7 kHz and 40 Hz inputs
  - Max. counting capacity 99.999.999 impulses
- Hour counter/chronometer :
  - Start/stop/ inputs
  - 4 time ranges : 99.999.9 hours - 99.999.9 min  
99.999.9 s - 99 h 59 min 59 s
  - Lithium battery powered
  - Reset either from front panel or remotely



### Specifications

Type	Designation	Code
2108	Impulse counter	87 610 340
2108H	Hour counter / chronometer	87 610 440

### Accessories

	Code
Adaptor for cut-out Ø 50 (dimensions Ø 73 mm)	26 546 829
Adaptor for cut-out 45 x 45 mm (dimensions 52 x 52 mm)	26 546 830
Adaptor for cut-out 25x50 mm (dimensions 29x54 mm)	26 546 831

### Dimensions

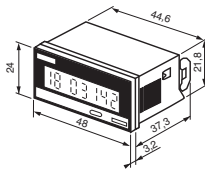

#### Panel cut-out

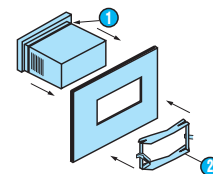
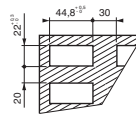

- 1 Seal
- 2 Fixing bracket

Accessory 2108 - 2108H  
26 546 829

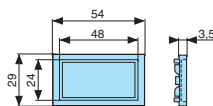

Accessory 2108 - 2108H  
26 546 830

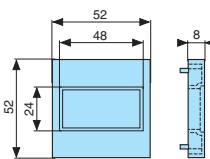

Accessory 2108 - 2108H  
26 546 831

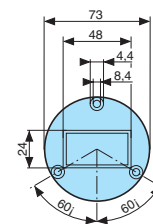

### Connections

#### 2108

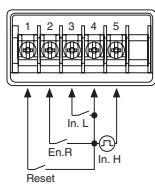

- 1 Reset input
- 2 Enable reset
- 3 Slow counting
- 4 0V
- 5 High-speed counting

#### 2108H

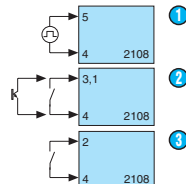

- 1 High-speed counting input
- 2 Slow counting input and reset
- 3 Enable reset input

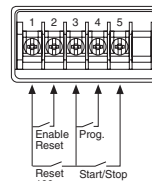

- 1 Reset input
- 2 Enable reset
- 3 Common
- 4 Prog.
- 5 Start/Stop

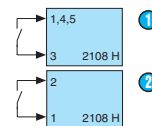

- 1 Start/Stop input Prog. Reset
- 2 Enable Reset input

To order, see page 6



## General characteristics

Functions	Impulse counter (2108) Hour counter/chronometer (2108H)
Solid state input	•
Display	8 digits LCD (2108) 6 digits LCD (2108H)
Height of digits	7 mm
Counting capacity	0 to 99 999 999 (2108)
Time ranges	For the 2108H : 0 to 99 999.9h 0 to 99 999.9min 0 to 99 999.9s 0 to 99h59min59s
Time base	Quartz (precision $\pm 50$ ppm)
Possibility of reloading current value	• (2108H)
<b>Input</b>	
Volt-free contact	For the 2108H : 1 Start/Stop input 40 ms min (terminals 3-5) 1 Reset input (RAZ) 100 ms min (terminals 1-3) 1 Prog input (terminals 3-4) 1 Authorised reset input (terminals 1-2)
Slow counting input (In.L)	For the 2108: 40 Hz TOFF : 12 ms min TON : 12 ms min Current output : 52 $\mu$ A max Leakage current in OFF state 0.2 $\mu$ A max Residual voltage : 0.4 V max Volt-free contact or transistor NPN open collector
High-speed input (In.H)	For the 2108: 7 kHz max TOFF : 70 $\mu$ s min TON : 70 $\mu$ s min Level 0 : 0 to 1 VDC Level 1 : 4 to 30 VDC Current consumption : 6 mA max at 24 VDC
Reset to zero	Volt-free contact or transistor NPN open collector : 12 ms min (2108) 100 ms min (2108H)
Reset via	Front panel
Radiated field	IEC 1000-4-3, level 3, 10 V/ M 26 MHz to 1 GHz
Fast transients	IEC 1000-4-4, level 3, 1KV
Damped oscillatory wave	IEC 255.4, level 3, 1 KV
Electrostatic discharge	IEC 1000-4-2, level 3, 8 KV
<b>Function and use</b>	
Material	Self-extinguishing
Connection by screw terminals at rear of casing	5 terminals
Tightening capacity	2 x 1.5 mm <sup>2</sup>
Mounting	By bracket
Degree of protection front face	IP 64
Temperature limit operation (°C)	0 $\rightarrow$ +55
Temperature limits stored (°C)	-25 $\rightarrow$ +70
Conformity to standards VDE 0110 - ICE 664 - ICE 348 - ICE 255.4 - ICE 255.5 - ICE 801.2- ICE 801.4	•
Weight (g)	60
<b>Supply</b>	
1 lithium battery - Life (years)	8 (2108) 5 (2108H)

# Hour counters - LCD 24 x 48

## → 2213/2214

- Start input and zero reset : solid state (2213) or voltage (2214)
- Integral module for voltage inputs (5-50VAC/VDC, 48-240 VAC)
- 4 time ranges 99.999.9 h, 99.999.9 min, 99.999.9 s, 99 h 59 min 59 s
- Possibility of loading the current value
- Lithium battery supply - 5-year life
- Reset to zero : front panel or external with inhibit facility
- Bezels for 25 x 50, 45 x 45, Ø 50



### Specifications

Type	Designation	Code
2213	Hour counter - LCD 24 x 48 solid state input	87 610 140
2214	Hour counter - LCD 24 x 48 voltage input	87 610 150

### Accessories

	Code
Adaptor for cut-out Ø 50 (dimensions Ø 73 mm)	26 546 829
Adaptor for cut-out 45 x 45 mm (dimensions 52 x 52 mm)	26 546 830
Adaptor for cut-out 25 x 50 mm (dimensions 29 x 54 mm)	26 546 831

### Dimensions

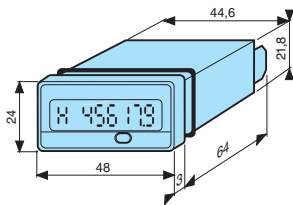

Unit spacing

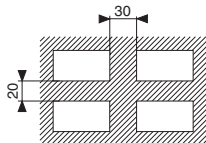

Accessory 26 546 831

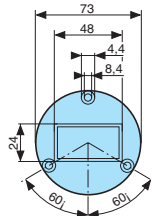

Ratchet action fixing yoke

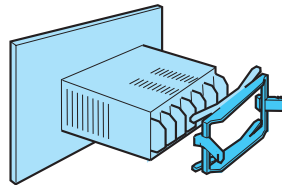

Accessory 26 546 829

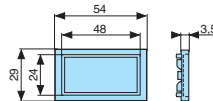

Panel cut-out (Max. thickness 10 mm)  
1 unit

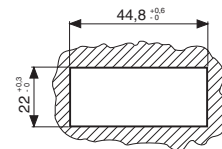

Accessory 26 546 830

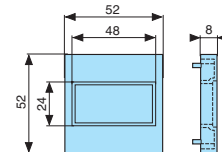

## General characteristics

Functions	Hour counter
Display	6 digits LCD
Height of digits	7 mm
Time ranges	0 to 99 999.9h 0 to 99 999.9min 0 to 99 999.9s 0 to 99h59min59s
Time base : Crystal controlled (Accuracy $\pm$ 50)	•
Possibility of reloading current value	•
<b>Input 2213</b>	
One start/stop input by volt-free contact or NPN/PNP open-collector transistor (terminals 3-4)	•
Minimum time closed	40 ms
<b>Input 2214</b>	
One start/stop input Two voltage levels	•
Terminals 4 - 5	5 - 50 V AC / DC
Terminals 5 - 6	48 - 240 V AC
Minimum pulse time AC	50 ms
Minimum pulse time DC	35 ms
<b>Reset to zero - Panel</b>	
Switch no2 to OFF	inhibited
Switch no2 to ON	active
<b>Reset to zero - External 2213</b>	
Volt-free contact or open collector (terminals 1-2)	•
Min time closed	100 ms
<b>Reset to zero - External 2214</b>	
Voltage - Terminals 2-3	5 - 50 V AC / DC
Voltage - Terminals 1-2	48 - 240 V AC
Minimum pulse time	100 ms
The reset is galvanically isolated from the counting input (2214-only)	•
<b>Supply</b>	
2213 and 2214 1 lithium battery Service life (years)	5
Supply can be switched off by Dipswitch-n° no 1 situated underneath the unit	•
<b>Function and use</b>	
Material	Self-extinguishing
Connection by 6 screw terminals at rear of casing	•
Tightening capacity	2*1.5 mm <sup>2</sup>
Fixed using bracket	•
Degree of protection front face	IP 66
Temperature limit operation (°C)	-10 → +55
Temperature limits stored (°C)	-20 → +70
Conformity to standards VDE 0110 - ICE 664 - ICE 348 - ICE 255.4 - ICE 255.5 - ICE 801.2- ICE 801.4	•
Weight (g)	2213 : 60 2214 : 65

2213

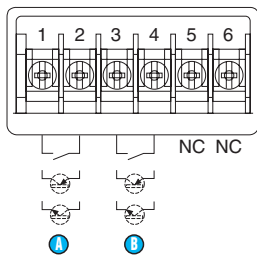

- A Reset inputs
- B Start/stop inputs
- 1 Reset input
- 2 Reset common
- 3 Start/stop common
- 4 Start/stop input
- 5 Not connected
- 6 Not connected

**Start-stop input or reset input - 2213 NPN transistor**

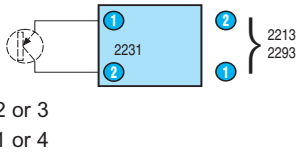

- 1 2 or 3
- 2 1 or 4

**Reset 2214 : voltage**

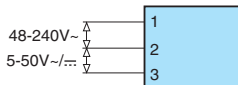

**Start/Stop input 2214 : PNP transistor or 3-wire PNP proximity switch (for switch with leakage current ≤ 0.1 mA)**

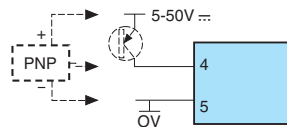

**Reset 2214 : NPN transistor or 3-wire NPN proximity switch (for switch with leakage current ≤ 0.1 mA)**

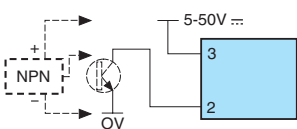

**Start/Stop input 2214 : 2-wire proximity switch**

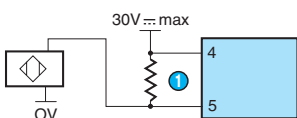

\*\* R= 470 Ω / 2 W for a 2-wire switch with leakage current ≤ 1.5 mA

**Start-stop input or reset input - 2213 Volt-free contact**

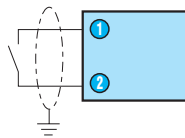

- A Reset inputs
- B Start/stop inputs
- 1 Reset 48 to 240 V AC
- 2 Reset common
- 3 Reset 5 to 50 V AC / DC
- 4 5 to 50 V AC / DC
- 5 Start/stop common
- 6 48 to 240 V AC

**Start-stop input or reset input - 2213 PNP transistor**

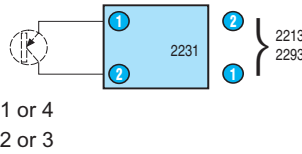

- 1 1 or 4
- 2 2 or 3

**Start/Stop input 2214 : live contact**

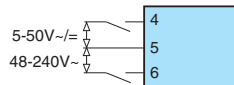

**Reset 2214 : PNP transistor or 3-wire PNP proximity switch (for switch with leakage current ≤ 0.1 mA)**

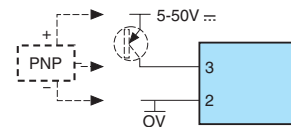

**Start/Stop input 2214 : 2-wire proximity switch**

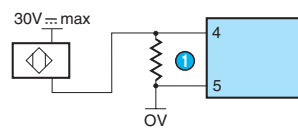

\*\* R= 470 Ω / 2 W for a 2-wire switch with leakage current ≤ 1.5 mA

**Reset 2214 : 2-wire proximity switch**

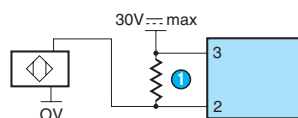

\*\* R= 470 Ω / 2 W for a 2-wire switch with leakage current ≤ 1.5 mA

**Start-stop input or reset input - 2213 Volt-free contact**

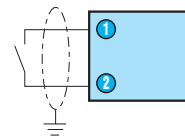

- 1 2 or 3
- 2 1 or 4

**Start/Stop input 2214 : voltage**

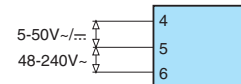

**Reset 2214 : live contact**

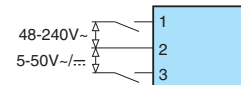

**Start/Stop input 2214 : NPN transistor or 3-wire NPN proximity switch (for switch with leakage current ≤ 0.1 mA)**

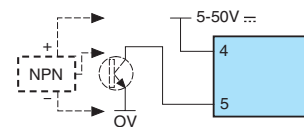

**Reset 2214 : 2-wire proximity switch**

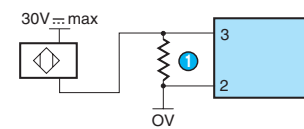

\*\* R= 470 Ω / 2 W for a 2-wire switch with leakage current ≤ 1.5 mA



# Totalizers - LCD 24 x 48

→ CP2 : 2231 / 2232

- Display : 8 digit LCD, 7 mm height
- Supply : alkaline batteries or lithium batteries
- Counting input : solid state (4-30 VDC) or voltage (up to 240 VAC)
- Dimensions DIN - 24 x 48 mm
- Reset to zero : front panel or external with inhibit facility
- Bezels 25 x 50, 45 x 45, Ø50



## Specifications

Type	Designation	Code
2231	Solid state input, lithium battery	87 610 040
2232	Voltage input, lithium battery	87 610 050

## Accessories

	Code
Adaptor for cut-out Ø 50 (dimensions Ø 73 mm)	26 546 829
Adaptor for cut-out 45 x 45 mm (dimensions 52 x 52 mm)	26 546 830
Adaptor for cut-out 25 x 50 mm (dimensions 29 x 54 mm)	26 546 831

## Dimensions

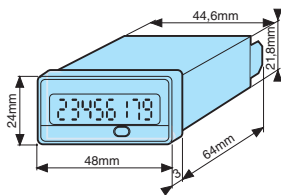

Ratchet action fixing yoke

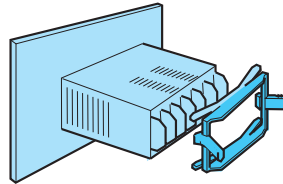

Panel cut-out (Max. thickness 10 mm) 1 unit

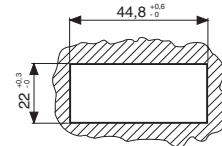

Unit spacing

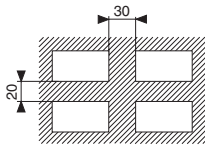

Accessory 26 546 829

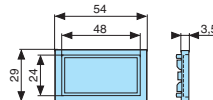

Accessory 26 546 831

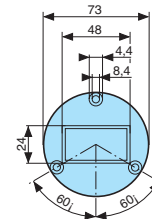

Accessory 26 546 830

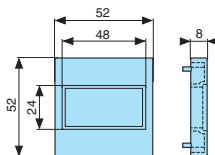

## General characteristics

Functions	Impulse counter
Display	8 digits LCD
Height of digits	7 mm
Counting capacity	0 to 99 999 999

### Input 2231

1 slow counting input for contact closure on NPN open-collector transistor input (terminals 3-4)	•
1 input for high speed counting signal from voltage level (terminals 3-5)	4-30 V DC
Low level	0-0.7 V DC
High level	4-30 V DC

### Input 2232

1 input for slow counting 2 voltage levels	•
Terminals 4 - 5	5-50 V AC / DC
Terminals 5 - 6	48-240 V AC

### Reset to zero - Panel

Switch no.2 to OFF	inhibited
Switch no.2 to ON	active

### Reset to zero - External 2231

Volt-free contact or open collector (terminals 1-2)	•
---	---

### Reset to zero - External 2232

Voltage - Terminals 2-3	5-50 V AC / DC
Voltage - Terminals 1-2	48-240 V AC
The reset is galvanically isolated from the counting input	•
Slow counting	40 Hz
Minimum pulse time.	12 ms
Low level . High level	
High-speed counting (2231)	7.5 kHz max.
High-speed counting (2231)	70 µs
Low level - High level	
Input levels	4 - 30 V DC
Input impedance (kΩ)	3.5 KΩ min

### Supply

2 alkaline batteries - Life (years)	4
1 lithium battery - Life (years)	8
Supply can be switched off by Dipswitch-n° no 1 situated underneath the unit	•

### Function and use

Material	Self-extinguishing
Connection by 6 screw terminals at rear of casing	•
Tightening capacity	2*1.5 mm <sup>2</sup>
Fixed using bracket	•
Degree of protection front face	IP 66
Temperature limit operation (°C)	-10 → +55
Temperature limits stored (°C)	-20 → +70
Insulation resistance (IEC 255.5)	100 MΩ (500 V=)
Breakdown voltage according to IEC 255-5	2000 V / 50 HZ / 1 min.
Conformity to standards VDE 0110 - ICE 664 - ICE 348 - ICE 255.4 - ICE 255.5 - ICE 801.2- ICE 801.4	•
Weight (g)	2231 : 60 2232 : 65

## Connections

### 2231

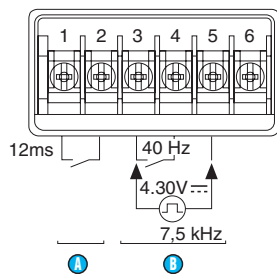

- ① Reset input
  - ② 0 V Reset
  - ③ 0 V counting
  - ④ Slow counting
  - ⑤ High-speed counting
- A : Reset input  
B : Counting inputs

### 2232

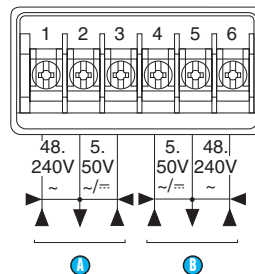

- ① Reset 48 to 240 V AC
  - ② 0 V Reset
  - ③ Reset 5 to 50 V AC / DC
  - ④ 5 to 50 V AC DC
  - ⑤ 0 V
  - ⑥ 48 to 240 V AC
- A : Reset input  
B : Counting inputs

### High-speed counting input 2231

NPN transistor or 3-wire NPN proximity switch

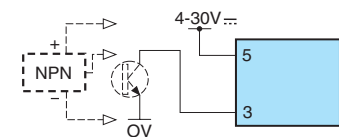

**High-speed counting input 2231**  
Voltage

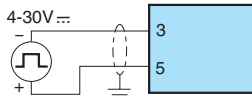

**Slow counting input or reset input - 2231**  
**Start-stop input or reset input - 2213**  
**Counting and general reset input - 2293**

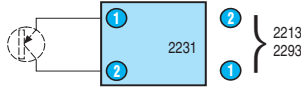

- 1 1 or 5
- 2 2 or 3

**Slow counting input or reset input : 2231**  
Volt-free contact

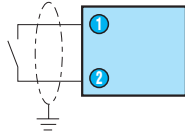

- 1 1 or 4
- 2 2 or 3

**Counting input 2232 :**  
Live contact

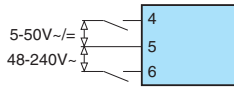

**Reset 2232 :**  
**PNP transistor or 3-wire PNP proximity switch**  
(for switch with leakage current  $\leq 1$  mA)

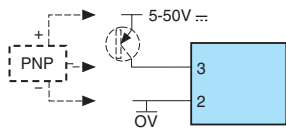

**Counting input 2232 : 2-wire proximity switch\*\***

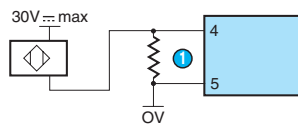

\*\*R = 470  $\Omega$  / 2 W for a 2-wire switch with leakage current  $\leq 1.5$  mA

**Reset 2232 : 2-wire proximity switch\*\***

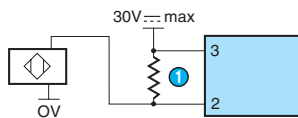

\*\*R = 470  $\Omega$  / 2 W for a 2-wire switch with leakage current  $\leq 1.5$  mA

**Slow counting input or reset input - 2231**  
**Start-stop input or reset input - 2213**  
**Counting and general reset input - 2293**

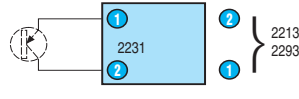

- 1 1 or 4
- 2 2 or 3

**High-speed counting input 2231**  
2-wire proximity switch

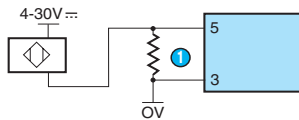

**Counting input 2232 :**  
Voltage

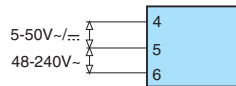

**Reset 2232 :**  
Live contact

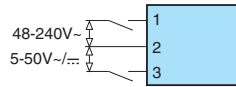

**Counting input 2232 :**  
**NPN transistor or 3-wire NPN proximity switch**  
(for switch with leakage current  $\leq 1$  mA)

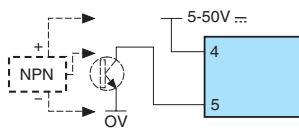

**Reset 2232 : 2-wire proximity switch\*\***

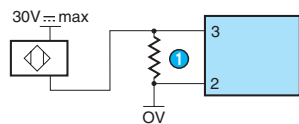

\*\*R = 470  $\Omega$  / 2 W for a 2-wire switch with leakage current  $\leq 1.5$  mA

**High-speed counting input 2231**  
**PNP transistor or 3-wire PNP proximity switch**  
(for switch with leakage current  $\leq 1$  mA)

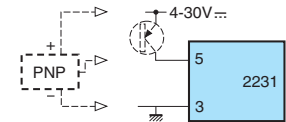

**High-speed counting input 2231**  
2-wire proximity switch

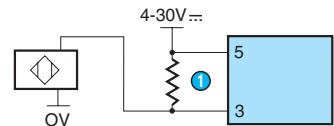

**Reset 2232 :**  
voltage

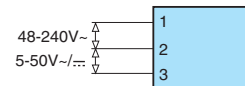

**Counting input 2232 :**  
**PNP transistor or 3-wire PNP proximity switch**  
(for switch with leakage current  $\leq 1$  mA)

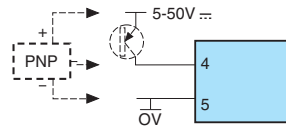

**Reset 2232 :**  
**NPN transistor or 3-wire NPN proximity switch**  
(for switch with leakage current  $\leq 1$  mA)

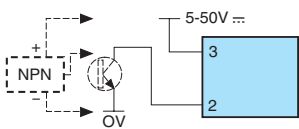

**Counting input 2232 : 2-wire proximity switch\*\***

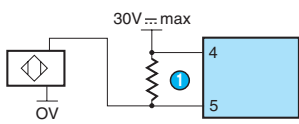

\*\*R = 470  $\Omega$  / 2 W for a 2-wire switch with leakage current  $\leq 1.5$  mA





# Total/partial impulse counters - LCD 24 x 48

→ 2293/2294

- Partial or total count display
- Counting capacity : partial : 0 to 999.999 total : 0 to 99.999.999
- Counting inputs and reset inputs : solid state (2293) voltage (2294)
- Decimal point
- Integral module for voltage inputs (5 to 50 V AC / DC, 48 to 240 V AC)
- Lithium battery. 5 years life
- Panel reset to zero facility for the partial count
- Panel or electrical reset to zero for the total count
- Bezels for 25 x 50, 45 x 45, Ø 50



## Specifications

Type	Designation	Code
2293	Solid state input	87 610 240
2294	Voltage input	87 610 250

## Accessories

	Code
Adaptor for cut-out Ø 50 (dimensions Ø 73 mm)	26 546 829
Adaptor for cut-out 45 x 45 mm (dimensions 52 x 52 mm)	26 546 830
Adaptor for cut-out 25 x 50 mm (dimensions 29 x 54 mm)	26 546 831

## Dimensions

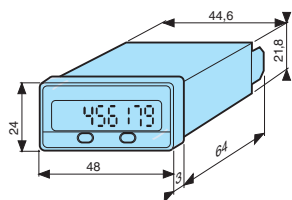

Panel cut-out (Max. thickness 10 mm) 1 unit

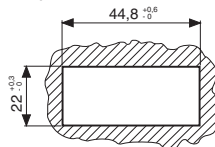

Unit spacing

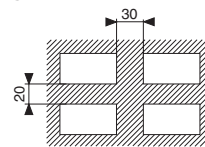

Ratchet action fixing yoke

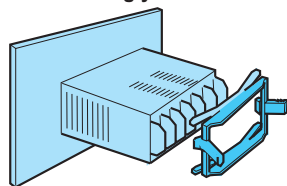

Accessory 26 546 829

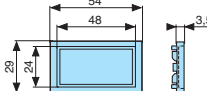

Accessory 26 546 830

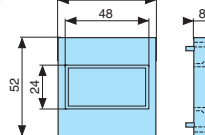

Accessory 26 546 831

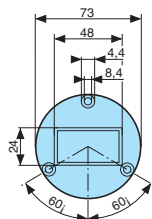

## General characteristics

Functions	Impulse counter
Display	8 digits LCD
Height of digits	7 mm
Counting capacity	0 to 99 999 999
<b>Input 2293</b>	
One counting input by volt-free contact or NPN/PNP open-collector transistor (terminals 3 - 4)	•
Minimum time closed	40 ms
<b>Input 2294</b>	
1 counting input 2 voltages levels	•
Terminals 4 - 5	5-50 V AC / DC
Terminals 5 - 6	48-240 V AC
The inputs are galvanically isolated from one another	•
<b>Reset to zero - Panel</b>	
Always enabled for partial counter	•
<b>Reset to zero - External 2293 (total counter)</b>	
Volt-free contact or NPN open-collector transistor (terminals 1-2)	•
Minimum time closed	40 ms
<b>Reset to zero - External 2294 (total counter)</b>	
Voltage - Terminals 2-3	5-50 V AC / DC
Voltage - Terminals 1-2	48-240 V AC
Minimum time closed	40 ms
The reset is galvanically isolated from the counting input (2294-only)	•
<b>Counting speed</b>	
2293 Selectable from dipswitch n°4	14 or 100 Hz
2294	14 Hz
Slow counting	14 Hz max
Minimum pulse time.Low level . High level	35 ms
High-speed counting	Maximum 100 Hz Minimum pulse time low level 5 ms, high level 5 ms
Minimum pulse time.Low level . High level	5 ms
<b>Supply</b>	
2293 - 2294 - 1 lithium battery Service life (years)	5
Supply can be switched off by Dipswitch-n° no 3 situated underneath the unit	•
<b>Function and use</b>	
Material	Self-extinguishing
Connection by 6 screw terminals at rear of casing	•
Tightening capacity	2 x 1.5 mm <sup>2</sup>
Fixed using bracket	•
Degree of protection front face	IP66
Temperature limit operation (°C)	-10 → +55
Temperature limits stored (°C)	-20 → +70
Conformity to standards VDE 0110 - ICE 664 - ICE 348 - ICE 255.4 - ICE 255.5 - ICE 801.2-ICE 801.4	•
Weight (g)	2293 : 60 2294 : 65

2293

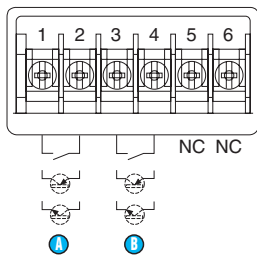

- A General reset input  
 B Counting inputs  
 ① General reset input  
 ② General reset common  
 ③ Count common  
 ④ Counting  
 ⑤ Not connected  
 ⑥ Not connected

**Start/stop input or reset input - 2293**  
 NPN transistor

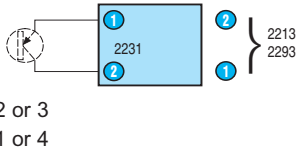

- ① 2 or 3  
 ② 1 or 4

**Reset 2294**  
 Voltage

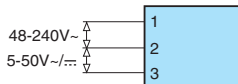

**Reset 2294**  
 PNP transistor or 3-wire PNP proximity switch (for switch with leakage current  $\leq 0.1$  mA)

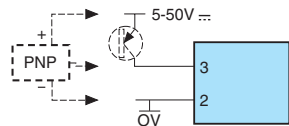

**Reset 2294**  
 NPN transistor or 3-wire NPN proximity switch (for switch with leakage current  $\leq 0.1$  mA)

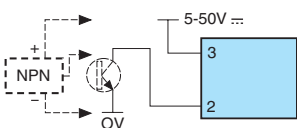

**Counting input 2294**  
 2-wire proximity switch

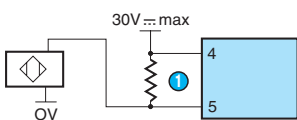

\*\* R = 470  $\Omega$  / 2 W for a 2-wire switch with leakage current  $\leq 1.5$  mA

2294

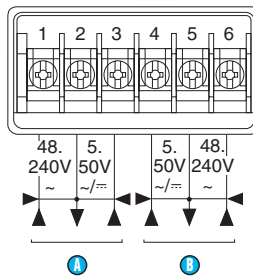

- A General reset inputs  
 B Counting inputs  
 ① Reset 48 to 240 V AC  
 ② General reset common  
 ③ Reset 5 to 50 V AC / DC  
 ④ 5 to 50 AC DC  
 ⑤ Count common  
 ⑥ 48 to 240 V AC

**Counting and general reset input - 2294**  
 PNP transistor

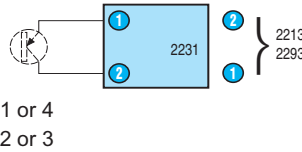

- ① 1 or 4  
 ② 2 or 3

**Counting input 2294**  
 Live contact

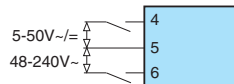

**Counting input 2294**  
 PNP transistor or 3-wire PNP proximity switch (for switch with leakage current  $\leq 0.1$  mA)

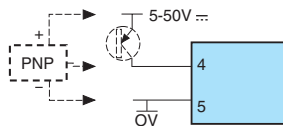

**Counting input 2294**  
 2-wire proximity switch

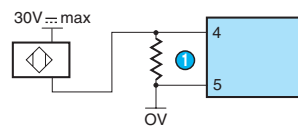

\*\* R = 470  $\Omega$  / 2 W for a 2-wire switch with leakage current  $\leq 1.5$  mA

**Reset 2294**  
 2-wire proximity switch

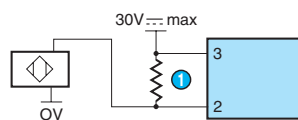

\*\* R = 470  $\Omega$  / 2 W for a 2-wire switch with leakage current  $\leq 1.5$  mA

**Counting and general reset input - 2293**  
 Volt-free contact

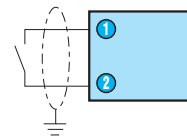

- ① 2 or 3  
 ② 1 or 4

**Counting input 2294**  
 Voltage

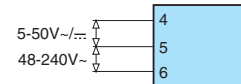

**Reset 2294**  
 Live contact

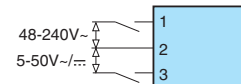

**Counting input 2294**  
 NPN transistor or 3-wire NPN proximity switch (for switch with leakage current  $\leq 0.1$  mA)

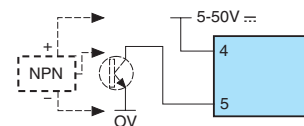

**Reset 2294**  
 2-wire proximity switch

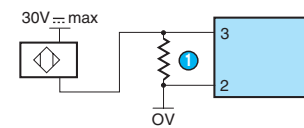

\*\* R = 470  $\Omega$  / 2 W for a 2-wire switch with leakage current  $\leq 1.5$  mA



# Totalizer - Ratemeter - Totalizer and Ratemeter - LCD 36 x 72

→ 3233 / 3253 / 3293

- Display LCD 10 mm
- Input : contact, voltage or solid-state (PNP/NPN)
- Front panel or electrical reset to zero
- Lithium battery - 8 years life
- Scale factor : 0.001 to 9999 (3253 and 3293)
- Decimal point selectable (3253 and 3293)
- Rate (3253 and 3293)



## Specifications

Type	Designation	Code
3233	Totalizer	87 614 040
3253	Ratemeter	87 614 340
3293	Totalizer counter and Ratemeter	87 614 440

## General characteristics

Lithium battery	3 V DC
Life (years)	8
A power supply must be provided for a sensor (12 V DC)	•
Material : self-extinguishing (UL94VO)	•
Degree of protection front face	IP 56
Mounting (panel-mounting/slide-action clips)	•
Connections at rear of case	Screw terminals
Waterproof gasket for panel sealing	•
Temperature limit operation (°C)	0 → +55
Temperature limits stored (°C)	0 → +70
Weight (g)	60

## Dimensions

panel cut-out

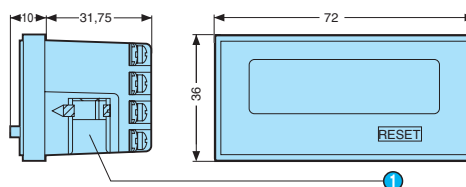
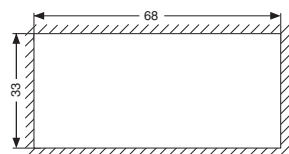

① Mounting

## Connections

### Terminal markings

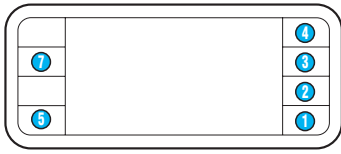

- ① Common 0 V
- ② Slow counting input
- ③ High-speed counting
- ④ Remote reset (3233 - 3293)
- ⑤ Enable/disable front reset button (3233) Programming (3253 - 3293)

### Type 3233

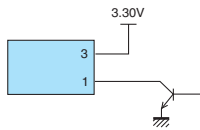

High-speed counting.  
NPN transistor.

### Type 3233 - 3253 - 3293

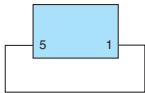

Front reset enable (3233)  
Programming enable (3293, 3253)

### Type 3293 - 3253

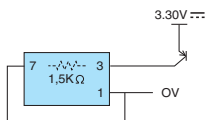

High speed counting. PNP transistor

### Type 3233

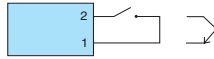

Slow counting  
Volt-free contact or NPN transistor

### Type 3233

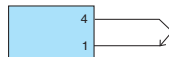

Remote reset.  
By NPN transistor.

### Type 3253 - 3293

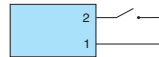

Slow counting.  
Volt-free contact.

### Type 3233 - 3293

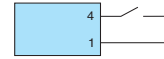

Remote reset by contact (3233)  
Remote reset, volt-free contact (3293)

### Type 3233

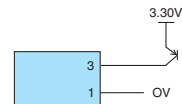

High-speed counting.  
PNP transistor.

### Type 3293 - 3253



High-speed counting.  
By NPN transistor or voltage level.

# Totalizer/hour counter module

## → C108

- Liquid crystal display : 8 digits, 7 mm high
- Low consumption
- Small dimensions
- Time base : Crystal controlled
- Sealed version (C108W)



### Specifications

Type	Designation	Code
C108	Sealed version	87 606 330

### General characteristics

Characteristics	
Functions	Impulse / hour counter
Display	8 digits LCD
Height of digits	7 mm
Counting capacity	0 to 99 999 999
Inputs	
1 input for high-speed counting signal from voltage level	•
Counting speed	7.5 kHz
Minimum pulse time	70 µs
Low level	0 → 0.7 V
High level	3 → 24 V
1 input for slow counting signal from volt-free contact or NPN open-collector transistor	•
Counting speed	40 Hz
Minimum time closed	12 ms
Reset	
Volt-free contact or NPN open-collector transistor	•
Min time closed	12 ms
Supply	3 V
Minimum	2.5 V
Maximum	4 V
Consumption	< 15 µA (typically 6 µA)
Function and use	
Material : Clear polycarbonate	•
Connection solder on to 6 pins or wire wrap	•
Mounted on p.c. by 2 screws and nuts	•
Protection C108	IP 40
Protection C108W	IP 67
Temperature limit operation (°C)	-10 → +50 °C
Temperature limits stored (°C)	-25 → +70 °C
Weight (g)	10

### Dimensions

#### Implantation

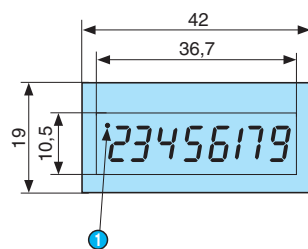
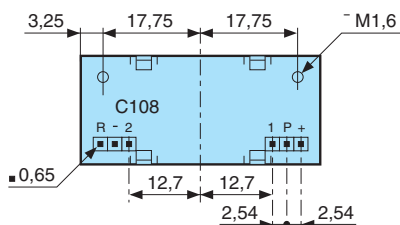

1 Symbol for display overrun

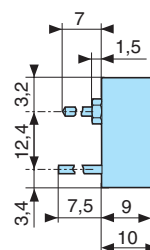



## Connections

### Terminal markings

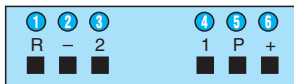

- 1 Reset
- 2 Supply
- 3 Slow input
- 4 High-speed input
- 5 Programming
- 6 Supply

## Applications

### High-speed counting 7.5 kHz

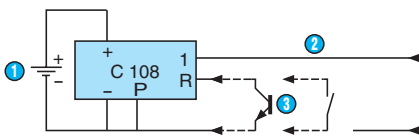

- 1 Battery supply 3 V
- 2 3 to 24 V voltage count
- 3 R to Z

$$U = 5 \text{ V} \rightarrow R = 180 \Omega$$

$$U = 12 \text{ V} \rightarrow R = 1 \text{ k}$$

$$U = 24 \text{ V} \rightarrow R = 2 \text{ k} 2$$

Precautions : these devices use CMOS technology and should be handled accordingly.

### Hour counter

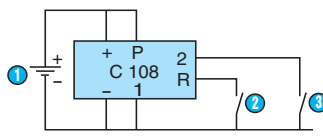

- 1 Battery supply 3 V
- 2 R to Z
- 3 Stop/Start

### High-speed counting 7.5 kHz

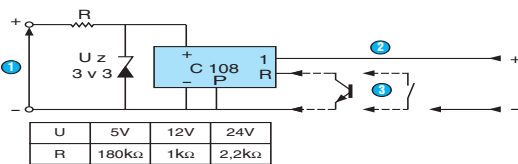

- 1 Supply
- 2 3 to 24 V voltage count
- 3 R to Z

$$U = 5 \text{ V} \rightarrow R = 180 \Omega$$

$$U = 12 \text{ V} \rightarrow R = 1 \text{ k}$$

$$U = 24 \text{ V} \rightarrow R = 2 \text{ k} 2$$

Precautions : these devices use CMOS technology and should be handled accordingly.

### Slow counting (max 40 Hz)

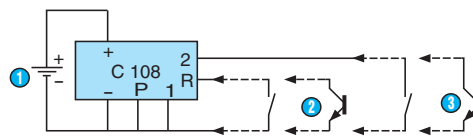

- 1 Battery supply 3 V
- 2 R to Z
- 3 Slow input

# Totalizer/hour counter module

→ 108

- Highly reliable
- Large 8 mm digits
- Very low consumption < 15  $\mu$ A (typically 6  $\mu$ A)
- Small dimensions
- With or without front panel reset



## Specifications

Type	Reset to zero	Version	Code
108	front panel and electrical	108 R	87 606 110
		panel mounting 108 ER	87 606 120
	electrical	108	87 606 010
		panel mounting 108 E	87 606 020

## General characteristics

Characteristics	
Functions	Impulse/hour counter
Display	8 digits LCD
Height of digits	8 mm
Counting capacity	For totalizer : 0 to 99 999 999 For hour counter : 0 to 99 999 h 99
Resolution	1/100h
Inputs	
1 input for high-speed counting signal from voltage level	•
Counting speed	7.5 kHz
Minimum pulse time	70 $\mu$ s
Low level	0 $\rightarrow$ 0.7 V
High level	2.5 • U <sub>e</sub> + 0.3 V
1 input for slow counting signal from volt-free contact or NPN open-collector transistor	•
Counting speed	40 Hz
Min time closed	12 ms
Reset	
Volt-free contact or NPN transistor	•
Minimum time closed	12 ms
Low level max	0.7 V
Supply	3 V
Minimum	2.5 V
Maximum	4 V
Function and use	
Temperature limit operation (°C)	-10 $\rightarrow$ +50 °C
Temperature limits stored (°C)	-25 $\rightarrow$ +70 °C

## Dimensions

### Mounting

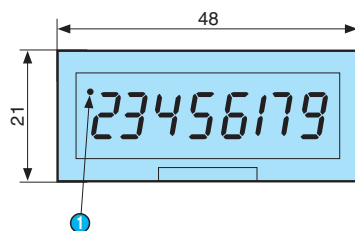
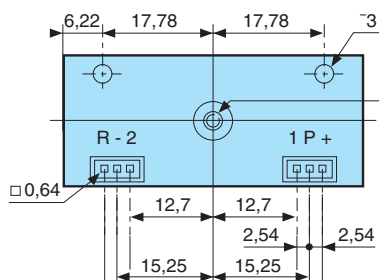

1 Symbol for display overrun

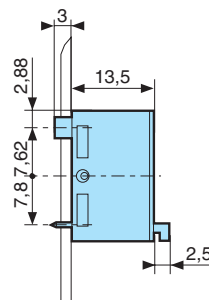

## Connections

### Terminal markings

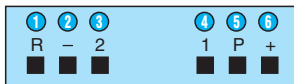

- 1 Reset
- 2 Supply
- 3 Slow input
- 4 High-speed input
- 5 Programming
- 6 Supply

## Applications

### Use of 108 - 108 R - Elapsed time function

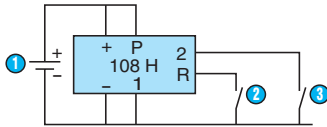

- 1 Battery supply 3 V
- 2 R to Z
- 3 Validation

### High-speed counting 7.5 kHz

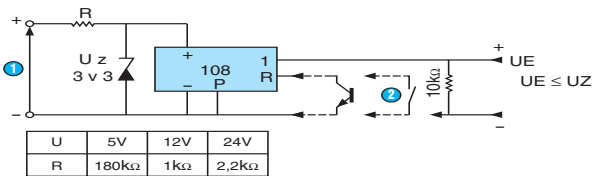

- 1 Supply
- 2 R to Z

### High-speed counting 7.5 kHz

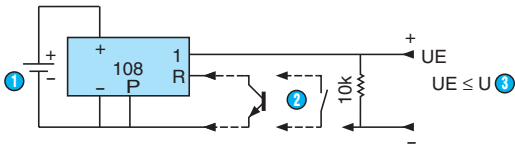

- 1 Battery supply 3 V
- 2 R to Z
- 3 Battery

### High-speed counting 7.5 kHz

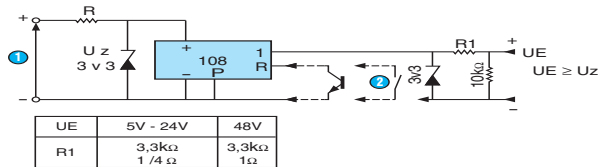

- 1 Supply
- 2 R to Z

### Slow counting (max 40 kHz)

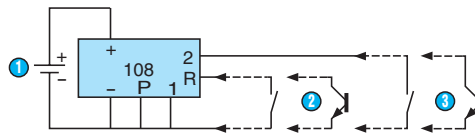

- 1 Battery supply 3 V
- 2 R to Z
- 3 Slow input

# Electro-mechanical impulse counters totalizing - 36 x 37

## → 36 x 37

- Front panel 36 x 37 mm
- 6 or 5 digits, 4 mm in height
- With or without manual zero reset
- White digits on black background



### Specifications

Type	Voltages	Frequency (Hz)	Code
Without zero reset	230 VAC	50 → 60	99 766 601
	115 VAC	50 → 60	99 766 602
	24 VAC	50 → 60	99 766 604
	24 VDC		99 766 607
With zero reset	230 VAC	50 → 60	99 766 610
	115 VAC	50 → 60	99 766 611
	24 VAC	50 → 60	99 766 613
	24 VDC		99 766 616

### General characteristics

Counting capacity	999 999 imp without zero reset 99 999 imp with zero reset
Height of digits	4 mm
Max. count rate	AC 18 imp / s DC 25 imp / s
Min. count rate	AC 28 ms DC 20 ms
Min pause time between 2 pulses	AC 28 ms DC 20 ms
Max. pulse length (count coil)	no limit
Voltage variation	+ 10 % / -15 % from Un
Absorbed power	24 V AC / 115 V AC : 1.1 VA 230 V AC : 2.1 VA 24 V DC : 0.8 W
Mechanical life count function (operations)	> 50 x 10 <sup>6</sup>
Voltage tests to IEC 255 5	U ≤ 60 V : 500 V U > 60 V : 2000 V
Protection Housing	IP 40
Protection Terminal	IP 00
Environmental protection	Metal parts protected (by surface treatment) or non-corroding
Maintenance	None
Operating position	Yes
Temperature limit operation (°C)	-10 → 60
Temperature limits stored (°C)	-40 → +80
Connection	6.35 Faston connectors or link screws
Mounting	2 x Ø 2.5 screws - F 90° on front panel
Weight (g)	50

To order, see page 6

## Dimensions

99 766 60 : 36 x 37 - 6 decades

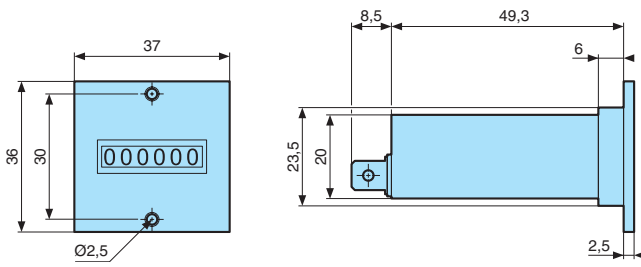

99 766 60 : Rear panels

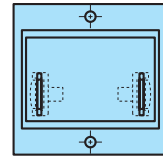

99 766 61 : 36 x 37 - 5 decades

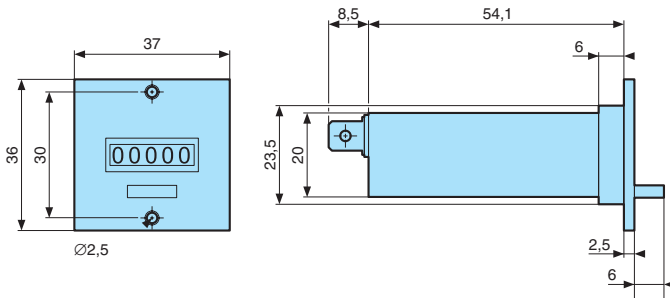

99 766 61 : Rear panels

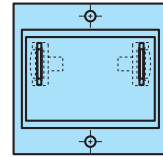

99 766 6 : Panel cut-out

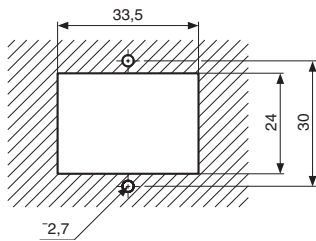

## Using information

No count pulse must be received during the zero reset time. If a pulse is received, damage may be caused.

# Electro-mechanical impulse counters totalizing - 24 x 48

## → 24 x 48

- Front panel 24 x 48 mm
- 6 or 5 digits, 4 mm in height
- With or without manual zero reset
- White digits on black background



### Specifications

Type	Voltages	Frequency (Hz)	Code
Without zero reset	230 VAC	50 → 60	99 766 901
	115 VAC	50 → 60	99 766 902
	24 VAC	50 → 60	99 766 904
	24 VDC		99 766 907
With zero reset (manual)	230 VAC	50 → 60	99 766 921
	115 VAC	50 → 60	99 766 922
	24 VAC	50 → 60	99 766 924
	24 VDC		99 766 927

### General characteristics

Counting capacity	999 999 imp, without zero reset 99 999 imp with zero reset
Height of digits	4 mm
Max. count rate	AC 18 imp/s DC 25 imp/s
Min. count rate	AC 28 ms DC 20 ms
Min pause time between 2 pulses	AC 28 ms DC 20 ms
Max. pulse length (count coil)	no limit
Voltage variation	+ 10 % / - 15 % from Un
Operator factor	100 %
Absorbed power	24 V AC / 115 V AC : 1.1 VA 230 V AC : 2.1 VA 24 V DC : 0.8 W
Mechanical life count function (operations)	> 50 x 10 <sup>6</sup>
Voltage tests to IEC 255 100	U ≤ 60 V : 500 V U > 60 V : 2000 V
Protection Housing	IP 40
Protection Terminal	IP 00
Environmental protection	Metal parts protected (by surface treatment) or non-corroding
Maintenance	None
Operating position	Yes
Temperature limit operation (°C)	-10 → +60
Temperature limits stored (°C)	-40 → +80
Connection	6.35 Faston connectors or link screws
Mounting	2 x M3 screws - F90° on front panel
Weight (g)	50

To order, see page 6

## Dimensions

99 766 90 : 24 x 48 - 6 decades

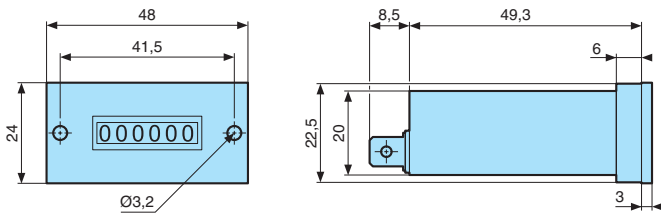

99 766 92 : 24 x 48 - 5 decades

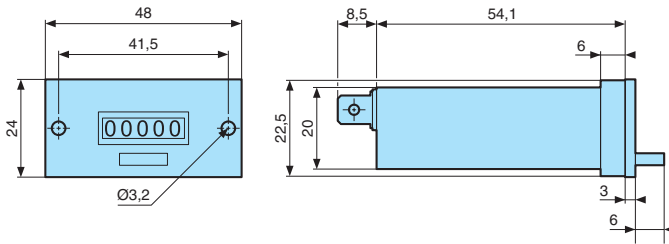

99 766 9 : Panel cut-out

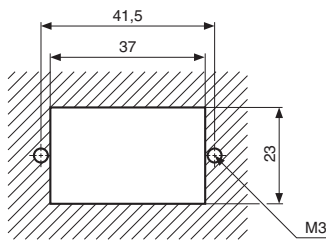

99 766 90 : Rear panels

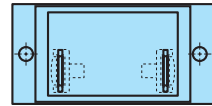

99 766 92 : Rear panels

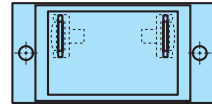

## Using information

No count pulse must be received during the zero reset time. If a pulse is received, damage may be caused.

# Electro-mechanical impulse counters totalizing - 36 x 48

## → 36 x 48

- Front panel 36 x 48
- 6 or 5 digits, 4 mm in height
- With or without manual zero reset
- White digits on black background



### Specifications

Type	Voltages	Frequency (Hz)	Code
Without zero reset	230 VAC	50 → 60	99 766 701
	115 VAC	50 → 60	99 766 702
	24 VAC	50 → 60	99 766 704
	24 VDC		99 766 707
Without zero reset (manual)	230 VAC	50 → 60	99 766 710
	115 VAC	50 → 60	99 766 711
	24 VAC	50 → 60	99 766 713
	24 VDC		99 766 716

### General characteristics

Counting capacity	999 999 imp, without zero reset 99 999 imp, with zero reset
Height of digits	4 mm
Max. count rate	AC 18 imp/s DC 25 imp/s
Min. count rate	AC 28 ms DC 20 ms
Min pause time between 2 pulses	AC 28 ms DC 20 ms
Max. pulse length (count coil)	no limit
Voltage variation	+ 10 % / - 15 % from Un
Absorbed power	24 V AC / 115 V AC : 1.1 VA 230 V AC : 2.1 VA 24 V DC : 0.8 W
Mechanical life count function (operations)	> 50 x 10 <sup>6</sup>
Voltage tests to IEC 255 100	U ≤ 60 V : 500 V U > 60 V : 2000V
Protection Housing	IP 40
Protection Terminal	IP 00
Environmental protection	Metal parts protected (by surface treatment) or non-corroding
Maintenance	None
Operating position	Yes
Temperature limit operation (°C)	-10 → +60
Temperature limits stored (°C)	-40 → +80
Connection	6.35 Faston connectors or link screws
Mounting	2 x Ø 2.5 F90° on front panel
Weight (g)	50

To order, see page 6



## Dimensions

99 766 70 : 36 x 48 : 6 decades

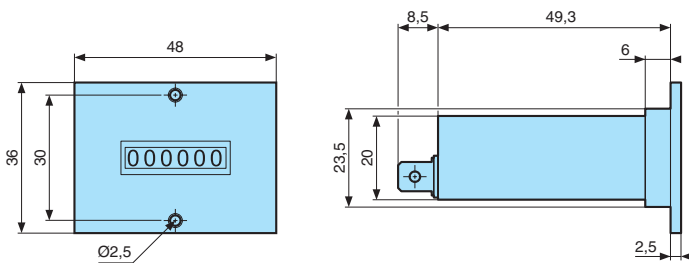

99 766 70 : Rear panels

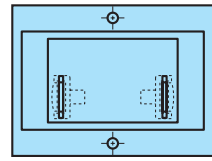

99 766 71 : 36 x 48 - 5 decades

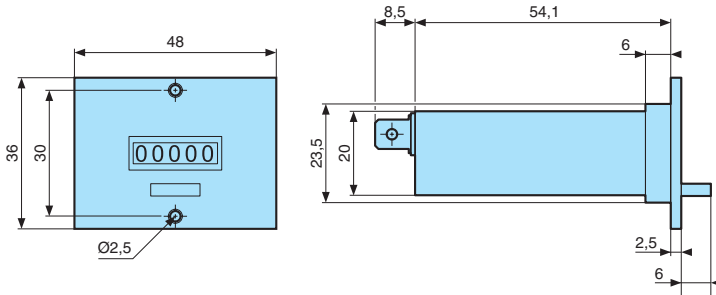

99 766 71 : Rear panels

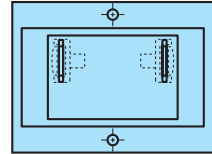

99 766 7 : Panel cut-out

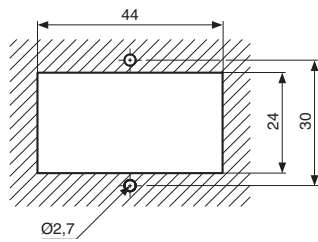

## Using information

No count pulse must be received during the zero reset time. If a pulse is received, damage may be caused.

# Electro-mechanical hour counter CH 48 G

## → CH 48 G

- 48 x 48 front panel
- Capacity 100.000 h (99.999 h)
- Run indicator
- Panel-mounted
- Can be mounted inside cabinet with DIN rail socket connector



### Specifications

Type	Frequency (Hz)	Voltages	Code
CH 48 G	50	220 to 240 VAC	99 761 714
		110 to 127 VAC	99 761 712
		36 to 48 VAC	99 761 711
	60	18 to 26 VAC	99 761 710
		110 to 127 VAC	99 761 715
		220 to 240 VAC	99 761 716
		24 to 30 VAC	99 761 718

### Accessories

	Code
DIN socket rail connector	26 546 803
Bezel (grey) 55 x 55 mm	26 546 805

### General characteristics

Counting capacity	99 999.99
Reset to zero	without
Read accuracy	1 / 100 h
Digit size	H x L : 3.8 x 1.6 mm
Colour of hour numbers	White on black
Colour of decimal digits	Red on black
Voltage variation	+ 10 - 15 % from Un
Time base	Synchronous motor
Max. absorbed power	1 VA
Motor start up	< 1 s
Voltage tests to IEC 255 100	U ≤ 60 V : 500 V U > 60 V : 2000 V
Accuracy	AC mains supply
Environmental protection	Metal parts protected (by surface treatment) or non-corroding Casing in Noryl - UL Listed
Degree of protection front face	IP 40
Operating position	Yes
Temperature limit operation (°C)	-20→ +55
Temperature limits stored (°C)	-40→ +80
Vibration resistance	10-2000 Hz / 0.5 G (IEC 68.2.6)
Approvals	UL - CSA - VDE
Connections (panel mounted version)	Tags 6.35 mm
Connections (DIN rail mounted version)	Screw terminals
Tightening capacity	2.5 mm <sup>2</sup>
Weight (g)	60

## Dimensions

### Panel-mounted

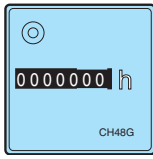

### DIN rail mounted via clip-on connector socket

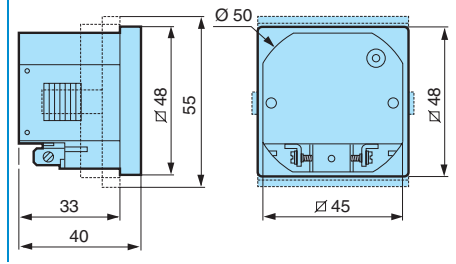

### Circular cut-out

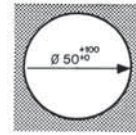

### Square cut-out

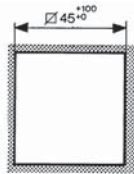

## Using information

with a 380 V AC supply, connect a 50 K $\Omega$ , W resistor in series with the 220 V



# Cam Timers



Features	Number of standard circuits	Rating	Standard cycle duration	Programm storage medium		
With external knob	7	10 A 250 AC	2 s to 24h	- Adjustable cams - Precut cams - Striker cams - Mixed	Page 274	
	12					
	17					
	22					
	31					
40						
With internal knob	5	10 A 250 AC	2 s to 24h	- Adjustable cams - Precut cams - Striker cams - Mixed	Page 274	
	10					
	15					
	20					
	29					
38						
Fast cycle-end or 2 speeds	5	10 A 250 AC	2 s to 24h	- Adjustable cams - Precut cams - Striker cams - Mixed	Page 274	
	10					
	15					
	20					
	29					
38						
6 to 22 circuits	6	10 A 250 AC	2 s to 24h	- Adjustable cams - Precut cams - Striker cams - Mixed	Page 276	
	8					
	10					
	12					
	14					
	16					
	18					
	20					
22						
2 to 4 circuits Panel-mounted	2	10 A 250 AC	2 s to 24h	- Adjustable cams - Precut cams - Striker cams - Mixed	Page 278	
	4					
2 to 4 circuits Base-mounted	2	10 A 250 AC	2 s to 24h	- Adjustable cams - Precut cams - Striker cams - Mixed	Page 278	
	4					
1 to 2 circuits	1	10 A 250 AC	2 s to 24h	- Adjustable cams - Precut cams - Striker cams - Mixed	Page 280	
	2					
1 to 3 circuits	1	10 A 250 AC	1 min to 30h	- Adjustable cams - Precut cams - Striker cams - Mixed	Page 282	
	2					
	3					

# Basic concepts relating to a timer

## Introduction

Our timers are pieces of automatic control equipment which, during a cycle, are intended to operate a series of contacts in a preset order following a program. The cycle may be single (non-repetitive), repetitive, or step by step. Though often decried, timers will greatly simplify automatic control systems and allow much other hardware to be dispensed with.

## Basic concept

They consist of:

- a driving device: gearmotor
- a program storage medium: adjustable, precut or striker cams
- and output devices: microswitches, miniature valves

### → Program storage mediums



Adjustable cam



Striker cam



Precut cam

Max space 180°

### → Program representation

The positions and sequence of the commands in the program will be fully defined by a diagram.

### → Diagram plotting

By convention, the lower line represents the rest position and the upper the working position. The heavy lines mean that the contact is closed. The total cycle duration is represented in degrees for the cams.

### → Important note

Only the **theoretical electrical** (or pneumatic) **values** will be used for plotting the diagrams. The equivalent mechanical values are peculiar to the individual unit and are calculated when setting up the program or cutting the cam contour.

**Example:** Diagramm for a cam timer

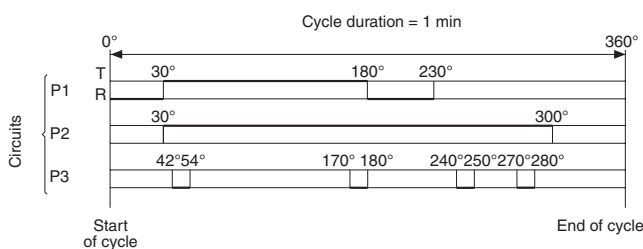

At the same time, a diagram plotted in this way also indicates the contour of the equivalent program storage medium : working = peak (or material present), rest = trough (or material cut away). A heavy line indicates that the contact is closed.

For ease of cutting, the troughs should preferably be shorter than the peaks

## Mechanical and electrical sizes

By convention, we have adopted these definitions:

- **Size of mechanical space** : the actual dimension, measurable on the program storage medium, of the feature which causes the contact to change over
- **Size of electrical** (or pneumatic) **space** : the electrical (or pneumatic) result obtained.

## Accuracy and repeatability

Basic definitions

- **Maximum repeatability error : (a)**  
Maximum possible difference between the theoretical size of a switching interval and the value obtained.
- **Maximum repeatability error :**  
Maximum + or - error from the mean likely to be found for a number of measurements of an interval between two switching points.
- **Switching interval :**  
Interval between any two points at which switching takes place (in the same circuit or two different circuits) in a diagram.

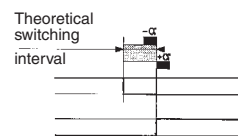

## Minimum time and interval between 2 switching

### → In the same circuit

The minimum time is determined by the speed of cam movement and the technology of each particular unit.

**For cam timers :** by providing a mechanical space sufficiently large to enable the lever of the output device to drop.

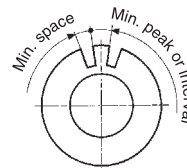

In the individual specifications, the minimum time is given as a proportion of a value which represents the duration of the program.

### → Example :

or the type 88 645 cam timer, the minimum time is equal to 1/60th of the total duration of a cycle. The minimum interval is restricted solely by the mechanical strength of the web of material between two successive spaces or by the thickness of the strikers. It is given as a proportion of the same reference value as the minimum time. For the program storage medium, i.e. the cam, N repetitions of a pairing of minimum time with minimum interval gives the maximum number of switching operations by the output device which are possible. This number is quoted in each specification.

### → Between 2 different circuits

The individual accuracy of any given unit and the scatter caused by the cutting or adjustment of the cams mean that we have to allow for a certain tolerance between the theoretical diagram and that actually obtained. When plotting the theoretical diagram, there are two possible eventualities:

- it is absolutely essential that the chronological order of the changes of state is maintained (Fig.A). When this is the case, the diagram interval between two switching operations must be at least equal to the accuracy.
- the chronological order of the changes of states need not be maintained (Fig. B)

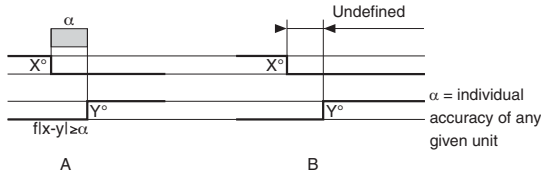

A copy (a photocopy or dyeline print) of the diagram shown below on page 273 will enable you to give us details of the particular profile to be cut in our works. The changeover points will need to be entered in degrees with due allowance for the characteristics of the timer selected. The cams are fitted in ascending numerical order reading away from the drive motor.

## Applications

There are vast numbers of possible applications for these timers. In the commonest application, the timer performs **repeated cycles** which cause contacts to be closed for fixed lengths of time. It may also perform a **single cycle** but the program is still a function of time in this case.

→ **Examples:** movement of automatic milling machine tables, periodic lubrication, animated shop-window displays, staged start-up of sets of pumps, automatic presses, industrial washing machines, etc.

The above applications are termed "open-ended" because the sequential progress of the operations is dependent solely on time and there is no check that the operation called for has actually taken place.

The main application for timers is in sequential automatic control systems where a check on the completion of an operation causes the next operation to begin (limit switch, thermostat, timeclock). When this is the case the timer is used in the **step by step** mode. The program is not run as a function of time but in response to external commands, and the motor merely serves to move the program forward in steps.

Step by step applications of this kind are in fact the ones for which timers can most usefully be employed. Though often decried, they allow automatic control systems to be greatly simplified and much of the hardware, such as relays and memories, needed for other techniques to be dispensed with.

In the same unit, the timer may control not only switching operations which follow one another in a precise order but also series of step by step sequences and sequences proportional to time, sequences run in two directions, and so on.

The circuits used are simple and there is a special technique for them which is easily modelled.

If the power fails, the timers may either:

- remain in position, in which case the orders given are held in store, which is an intrinsic feature of the device, or
- return to their starting point as soon as the power comes back on. The cycle then begins again from the beginning.

→ **Examples of step by step applications** (see page 284)

Control of machine tools, preselection counters, automatic car parks, vulcanising presses, systems for feeding livestock, etc.

## Some typical circuits

See page 284.

## Standards and approvals

Our timers are generally designed according to international standards, IEC, American standards (UL-CSA) and/or European standards (EN), VDE etc.

## Quality

### → Quality control

Our products are quality controlled systematically during assembly and on completion. The overseeing of control checks in the workshop, the use of data collected and possible product assessments which can occur form the essential role of Quality Control. All our products undergo a final check, either at 100% or on a selective basis following French standard X 06-022, which provides for a classification of possible defects in 3 groups : critical, major, minor.

Different tolerance thresholds (matching necessarily varied statistical analyses) are thus determined as a function of the possible repercussions of any anomalies during the life of the product in normal use, such as defined in the preceding sections. The size of the batches, the sampling quantities and the standards selected combine to define the thresholds.

### → Note:

According to customer requirements and for certain product ranges which must meet specific needs expressed in a specification, it is always possible to create or to modify a quality standard on a normal or special existing product and to vary the level of inspection. It can happen that the tolerance level is set at zero for certain parameters directly linked to the completion of a function for which total success must be assured : a defect is therefore fatal. Such specific requirements do, however, lead to a significant increase in product costs.



→ **Precut cam**



The cams are cut in our works to a diagram (see page 273) which you send us with your order.

→ **Adjustable cam**

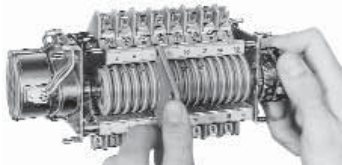

- Grey cam-half: beginning of setting (beginning of rest position)
  - Red cam-half: end of setting (end of rest position)
- The markings are read from the tool, as shown in the illustration above (except in the case of 88 655)

**Note:**

The accuracies quoted will be achieved provided the cams are always adjusted in the same direction of rotation.

A number in line with each cam allows the circuit concerned to be identified easily.

→ **Striker cam**

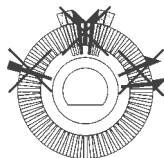
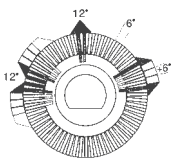

Striker cam part no. 79 222 640  
 (cam with 60 slots, increment 6°)  
 Pack of strikers, part no. 79 222 641  
 Kit comprising :

- 10 strikers for raising and lowering levers
  - 20 spacer strikers with an angular width of 6°
  - pliers for easier fitting and removal of the strikers.
- Other characteristics are the same as for the precut cam.

Setting a timer to the diagram shown below :

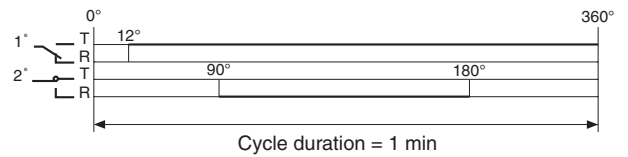

→ **Cam 1:**

(closest to motor) : move one of the segments to the point where the lever drops into the trough and lock it there; this point will form the beginning of the cycle. Switch the motor on for 2 seconds (equivalent to 12°) (starting and stopping are instantaneous). Move the second segment of the cam to the point where the microswitch is to change state and lock it there.

→ **Cam 2:**

Switch the motor on again for 13 seconds (interval between the end of the cam 1 space and the beginning of the cam 2 space). Set the beginning and end of the space in the same way as for cam 1.

→ **Note:**

In the case of simple diagrams which need no great accuracy, such as 2 cams each containing a minimum space, positioned 180° apart, turn the motor shaft by hand to find the points for tripping the microswitches by eye.

→ **Precut cams or complex diagrams:**

We see to the setting and cutting of the cams in our works. Please send us a diagram with your order (see page 273). Do not exceed the limiting characteristics of the timer: minimum space, minimum peak, maximum number of spaces, accuracy, maximum switching rate, etc.

# Cam timers 88 645, 5 to 40 circuits

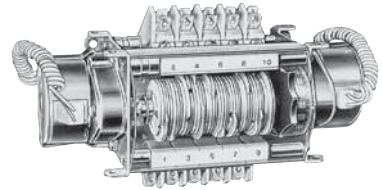
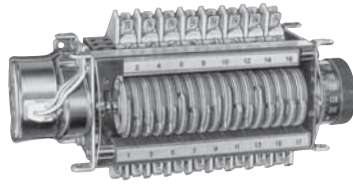
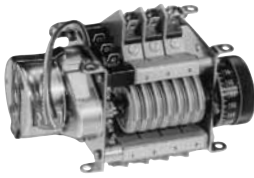

Standard cycle duration	2 s - 24 h	2 s - 24 h	2 s - 24 h
-------------------------	------------	------------	------------

## Types

### Features

Number of standard circuits

With external knob

7	<b>88 645 0</b>
12	<b>88 645 2</b>
17	<b>88 645 4</b>
22	<b>88 645 6</b>
31	<b>88 645 8</b>
40	<b>88 645 8</b>

With internal knob

5	<b>88 645 0</b>
10	<b>88 645 2</b>
15	<b>88 645 4</b>
20	<b>88 645 6</b>
29	<b>88 645 8</b>
38	<b>88 645 8</b>

With fast cycle-end or 2 speeds

5	<b>88 645 1</b>
10	<b>88 645 3</b>
15	<b>88 645 5</b>
20	<b>88 645 7</b>
29	<b>88 645 9</b>
38	<b>88 645 9</b>

## Characteristics

### Drive device

Type of standard gearmotor	82 334 5
Max voltage variation	+ 10 - 15 % of Un
Absorbed power	3.5 W
cos φ	0.6
Transition time	0.7 s
Single direction	1
Stopping performance - No. of rotor revs.	1/5
Number of off-load starts	2 x 106
Mechanical strength of gearbox	5 cm. daN
Method of gearmotor coupling (to cams)	External friction

### Program storage medium

Cams	adjustable, with strikers or precut
Minimum space or pulse (electrical)	12° (1/30 cycle duration)
Min. peak between two spaces (electrical)	12° (1/30 cycle duration)
Max. number of spaces per cam	adjustable : 1 with strikers or precut - 15
Max. switching rate in rotation	30 rpm

### Accuracy

Precision limit error	Adjustable cam ± 6° Precut cam ± 3.5°
Repeat accuracy	Adjustable cam ± 1° Precut cam ± 0.5°
Selection precision	1° (6° for cam with strikers)

### Output specification

Protected microswitch type	83 160 3
Rating	Nominal 10 A - 250 V Thermal 15 A -250 V
Mechanical life	10 <sup>7</sup> operations
Resistive torque per circuit	To trip 3 cm.N Tripped 0.5 cm.N

### General specifications

Permitted voltage variation at 55 °C maximum temperature is in accordance with IEC 255-1-00 (NFC 45250)	●
Duty factor	100 %
Temperature limits	Use -5 + 60 °C Stored -40 + 80 °C
Test voltages under IEC 255-5, VDE 0435/2021, IEC 536 class 1 (protection against electric shocks)	Voltages ≤ 60 V = 1000 V - Voltages > 60 V = 2000 V
Environmental protection	Tropicalised to IEC 68-2.10 standard
Operating position	Any
Protection IEC 529	IP 10
<i>The installer must ensure adequate guarding (&lt; IP20)</i>	
Conformity to standards NFC 45 250, IEC 255-1-00, VDE 0435/2021	●
Connection	Motors : to terminal strip Microswitches : W3 blade (6.35) W3 blade (6.35) See below
Approvals	By 2 screws M4 on Rn 50022 35 mm symmetrical J L DIN rail
* produced on request	
Mounting	See table page 275
Weight	

## Program storage medium

### Standard



Adjustable cam

### To special order



Precut cam (with no selector knob)  
On request

### To special order



Striker cam (strikers supplied with unit)

All 3 types of cam can be fitted to the same timer

## Standard cycle duration

Cycle duration	Gearbox output speed	Cycle duration	Gearbox output speed	Cycle duration	Gearbox output speed
* 2 s	30 rpm	90 s	2/3 rpm	** 1 h	1 rph
* 3 s	20 rpm	2 min	1/2 rpm	** 1 h 30	2/3 rph
* 4 s	15 rpm	3 min	1/3 rpm	** 2 h	1/2 rph
* 6 s	10 rpm	4 min	1/4 rpm	** 3 h	1/3 rph
* 7.5 s	8 rpm	5 min	1/5 rpm	** 4 h	1/4 rph
* 10 s	6 rpm	6 min	1/6 rpm	** 6 h	1/6 rph
* 12 s	5 rpm	10 min	1/10 rpm	** 12 h	1/12 rph
* 15 s	4 rpm	12 min	1/12 rpm	** 24 h	1/24 rph
* 20 s	3 rpm	15 min	1/15 rpm		
30 s	2 rpm	20 min	1/20 rpm		
60 s	1 rpm	30 min	1/30 rpm		

\* For stepping operation please enquire

\*\* At these speeds, allowance must be made for bounce and transition time.

## Direction of rotation

One-way or two-way (standard clockwise direction)  
Two-way motor type 82 524 0 : obtainable speed  $\square$ , for other speeds see motors catalogue

220 volt capacitor 0.1 μF ± 10 %. Ref: 26 231 903

## Supply voltage

Standard	1 direction - dual-voltage 127 / 220 V 50 Hz
	2 directions - single voltage 220 V - 50 Hz

## Accessories

Striker cams	79 222 640
Packet of extra strikers	79 222 641
Inverter for DC supply (for a 50 Hz AC motor of the same voltage)	12 V --- 84 861 502 24 • 48 V --- 84 861 501 110 • 127 V --- 84 861 503
Output power max. of 10 VA	

## Other information

Timers classed as Standard Products are only available from our distributors.

For other voltages and frequencies and DC, please consult us.

Basic concepts see page 271.

For some typical circuits, see page 284.

## Features

### 88 645

- Motor connections to terminal strip
- Easy adjustment with knob or tool

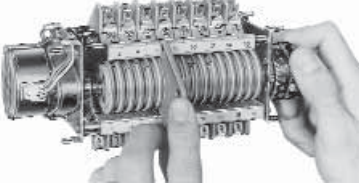

### Internal layout



### Microswitch operating curve

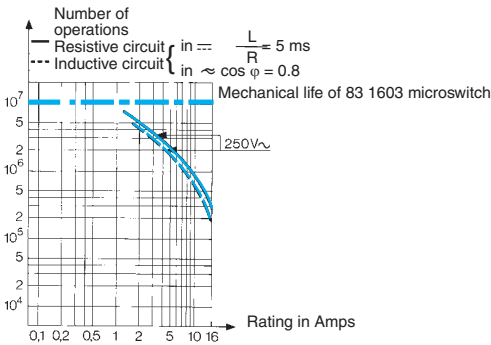

### Diagram

#### Gearmotor options

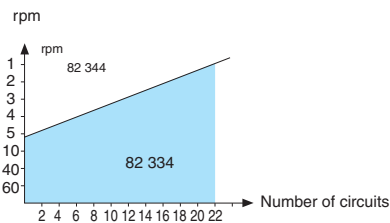

## Operation

The program can only be run in one direction. The gearmotors used are of the Y 82 334 5 type (with roller free-wheel)  
 High-speed gearmotor: max. speed is a function of the resistive torque.  
 Only versions with adjustable and striker cams are supplied with internal knob.  
 Versions with fully precut cams have no knob.  
 A - Low-speed motor clockwise  
 B - High-speed motor anti-clockwise

## Dimensions

### 88 645 0 with external knob

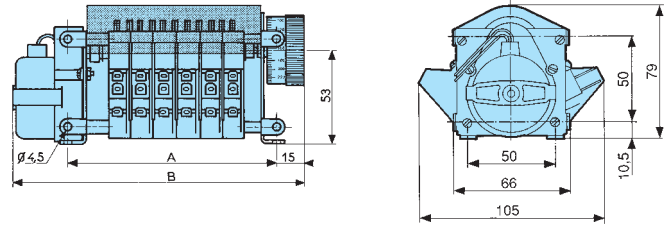

Types	Circuits	Dimension A	Dimension B	Weight (g)
88 645 0	7	82	130	550
88 645 2	12	116	164	750
88 645 4	17	148	196	900
88 645 6	22	148	196	1000
88 645 8	31	239	289	1300
88 645 8	40	310	360	1650

### 88 645 0 with internal knob

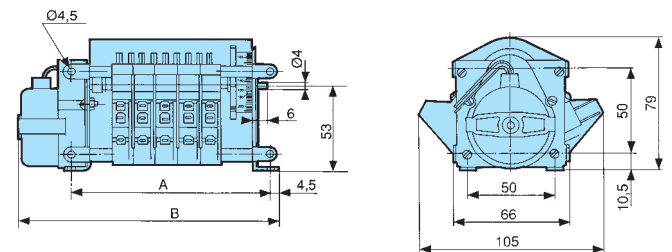

Types	Circuits	Dimension A	Dimension B	Weight (g)
88 645 0	5	82	119	500
88 645 2	10	116	153	700
88 645 4	15	148	185	850
88 645 6	20	180	217	950
88 645 8	29	239	278	1250
88 645 8	38	310	349	1600

### 88 645 0 with fast cycle-end or 2 speeds

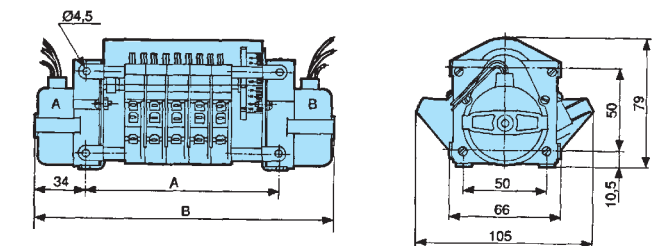

Types	Circuits	Dimension A	Dimension B	Weight (g)
88 645 1	5	82	149	760
88 645 3	10	116	183	960
88 645 5	15	148	215	1110
88 645 7	20	180	247	1210
88 645 9	29	239	308	1510
88 645 9	38	310	379	1860

## To order, specify:

Standard products, stocked

**1** Type

**2** Program storage medium

**3** Cycle duration

**4** Direction of rotation

**5** Supply voltage

**6** Accessory

Standard products, non stocked

Example : Cam timer with external knob 88 645 0 - 7 circuits - Adjustable cams - 60 s - 1 rpm - 127/240 V - 50 Hz - Packet of extra strikers 79 222 641

# Cam timers 88 650 from 6 to 22 circuits

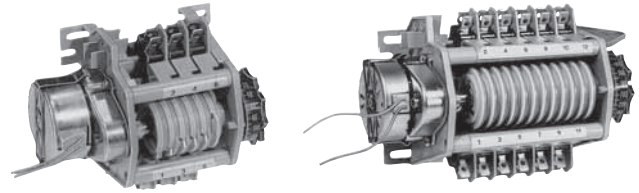

## Characteristics

### Drive device

Type of standard gearmotor depending on number of circuits and speed (see graph)	82 344 0	82 334 5
Max voltage variation	+ 10 - 15 % of Un	+ 10 - 15 % of Un
Absorbed power	3 W	3.5 W
cos φ	0.8	0.6
Transition time	0.7 s	0.7 s
Single direction	1	1
Stopping performance - No. of rotor revs.	1/5	1/5
Number of off-load starts	10 x 10 <sup>6</sup>	2 x 10 <sup>6</sup>
Mechanical strength of gearbox	5 cm. daN	5 cm. daN
Method of gearmotor coupling (to cams)	Friction	Friction

### Program storage medium

Cams	adjustable, with strikers or precut
Minimum space or pulse (electrical)	12° (1/30 cycle duration)
Min. peak between two spaces (electrical)	12° (1/30 cycle duration)
Max. number of spaces per cam	adjustable : 1 - with strikers or precut - 15
Max. switching rate in rotation	30 rpm

### Accuracy

Precision limit error	Adjustable cam ± 5.5° Precut cam ± 3.5°
Repeat accuracy	± 0.4°
Selection precision	1° (6° for cam with strikers)

### Output specification

Protected microswitch type	83 160 3
Rating	Nominal 10 A - 250 V Thermal 15 A - 250 V
Mechanical life	10 <sup>7</sup> operations
Resistive torque per circuit	To trip 3 cm.N Tripped 0.5 cm.N

### General specifications

Permitted voltage variation at 55 °C maximum temperature is in accordance with IEC 255-1-00 (NFC 45250)	•
Duty factor	100 %
Temperature limits	Use: -5 + 60 °C Stored: -40 + 80 °C
Test voltages under IEC 255-5, VDE 0435/2021, IEC 536 class 1 (protection against electric shocks)	Voltages ≤ 60 V = 1000 V - Voltages > 60 V = 2000 V
Environmental protection	Tropicalised to IEC 68-2.10 standard
Operating position	Any
Protection IEC 529	IP 10
<i>The installer must ensure adequate guarding (&lt; IP 20)</i>	
Conformity to standards NFC 45 250, IEC 255-1-00, VDE 0435/2021	•
Connection	Motors: Leads : 250 mm Microswitches: W3 blade (6.35)
Mounting	By 4 screw M4 on Rn 50022 35 mm symmetrical J L DIN rail
Weight	See table page 277

### Other information

Timers classed as Standard Products are only available from our distributors. For other voltages and frequencies and DC, please consult us. Basic concepts see page 271. For some typical circuits, see page 284.

Standard cycle duration

2 s - 24 h

### Types

Number of standard circuits	6	88 650 3
	8	88 650 4
	10	88 650 5
	12	88 650 6
	14	88 650 7
	16	88 650 8
	18	88 650 9
	20	88 650 9
	22	88 650 9

### Program storage medium

#### Standard



Adjustable cam

#### To special order



Precut cam (with no selector knob)  
On request

#### To special order



Striker cam (strikers supplied with unit)

All 3 types of cam can be fitted to the same timer

### Standard cycle duration

Cycle duration	Gearbox output speed	Cycle duration	Gearbox output speed	Cycle duration	Gearbox output speed
* 2 s	30 rpm	90 s	2/3 rpm	** 1 h	1 rph
* 3 s	20 rpm	2 min	1/2 rpm	** 1 h 30	2/3 rph
* 4 s	15 rpm	3 min	1/3 rpm	** 2 h	1/2 rph
* 6 s	10 rpm	4 min	1/4 rpm	** 3 h	1/3 rph
* 7.5 s	8 rpm	5 min	1/5 rpm	** 4 h	1/4 rph
* 10 s	6 rpm	6 min	1/6 rpm	** 6 h	1/6 rph
* 12 s	5 rpm	10 min	1/10 rpm	** 12 h	1/12 rph
* 15 s	4 rpm	12 min	1/12 rpm	** 24 h	1/24 rph
* 20 s	3 rpm	15 min	1/15 rpm		
30 s	2 rpm	20 min	1/20 rpm		
60 s	1 rpm	30 min	1/30 rpm		

\* For stepping operation please enquire

\*\* At these speeds, allowance must be made for bounce and transition time.

### Direction of rotation

1 or 2 directions

### Supply voltage

Standard 220 V 50 Hz

### Accessories

Striker cams	79 222 640
Packet of extra strikers	79 222 641
Inverter for DC supply (for a 50 Hz AC motor of the same voltage)	12 V ≡ 84 861 502 24 • 48 V ≡ 84 861 501 110 • 127 V ≡ 84 861 503
Output power max. of 10 VA	

9

## Features

- Easy adjustment with knob or tool (see page 271)
- Mounting by screws or on Rn 50022 35 mm symmetrical DIN rail (EN 50022)

### Internal layout

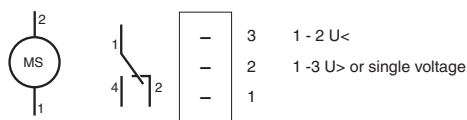

### Microswitch operating curve

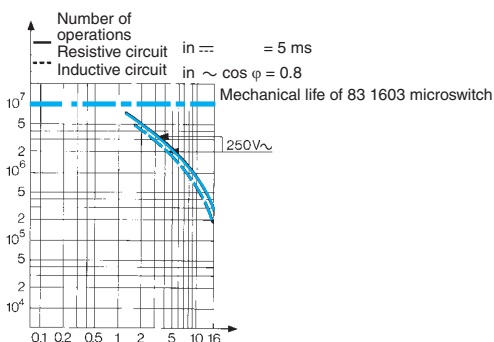

### Diagram

Gearmotor options

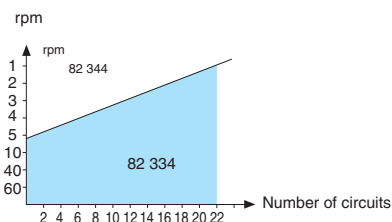

## Dimensions

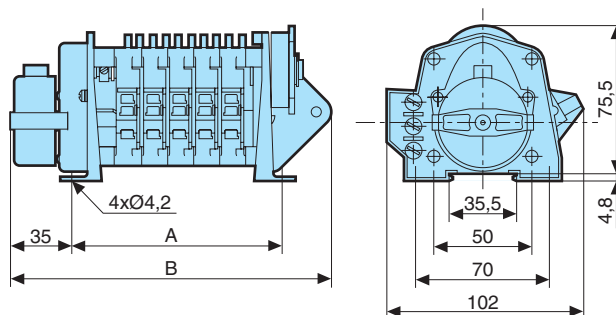

Types	Circuits	Dimension A	Dimension B*	Weight
<b>88 650 3</b>	6	84	142	345
<b>88 650 4</b>	8	97	155	390
<b>88 650 5</b>	10	110	168	435
<b>88 650 6</b>	12	123	181	480
<b>88 650 7</b>	14	136	194	525
<b>88 650 8</b>	16	149	207	570
<b>88 650 9</b>	18	162	220	615
<b>88 650 9</b>	20	175	233	660
<b>88 650 9</b>	22	188	246	705

\* For fitting with motor 82 334 5  
with motor 82 344 0 take off 6 mm

**Cam timers with fully precut cams and selector knob from 6 to 22 circuits**

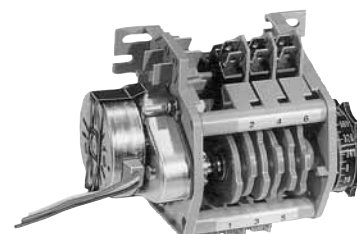

### Type

**88 650**

**1**

Supplied with internal or external selector knob; the graduations in this case merely show the progress of the cycle.

### To order, specify:

- 1 Type
- 2 Program storage medium
- 3 Cycle duration
- 4 Direction of rotation
- 5 Supply voltage
- 6 Accessory

Standard products, non stocked

Example : Cam timer 88 650 3 - Base-mounted - Adjustable cams - 60 s - 1 rpm - 1 direction - 220 V - 50 Hz - Packet of extra strikers 79 222 641

# Cam timers 88 646 from 2 and 4 circuits

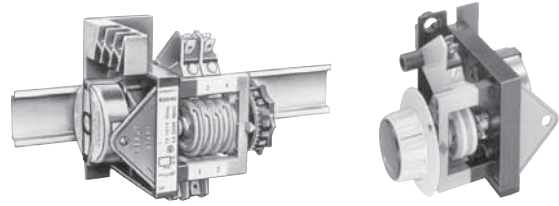

## Characteristics

### Drive device

Type of standard gearmotor	82 344 0	82 334 5>12 rpm
Max voltage variation	+ 10 - 15 % of Un	+ 10 - 15 % of Un
Absorbed power	3 W	3.5 W
cos φ	0.8	0.7
Transition time	0.7 s	0.4 s
Single direction	1	1
Stopping performance - No. of rotor revs.	1/5	1/5
Number of off-load starts	10 x 10 <sup>6</sup>	2 x 10 <sup>6</sup>
Mechanical strength of gearbox	5 cm. daN	5 cm. daN
Method of gearmotor coupling (to cams)	External friction	External friction

### Program storage medium

Cams	adjustable, with strikers or precut
Minimum space or pulse (electrical)	12° (1/30 cycle duration)
Min. peak between two spaces (electrical)	12° (1/30 cycle duration)
Max. number of spaces per cam	adjustable : 1 with strikers or precut - 15
Max. switching rate in rotation	30 rpm

### Accuracy

Precision limit error	Adjustable cam ± 6° Precut cam ± 3.5°
Repeat accuracy	Adjustable cam ± 1° Precut cam ± 0.5°
Selection precision	1° (6° for cam with strikers)

### Output specification

Protected microswitch type	83 160 3
Rating	Nominal 10 A - 250 V Thermal 15 A - 250 V
Mechanical life	10 <sup>7</sup> operations
Resistive torque per circuit	To trip 3 cm.N Tripped 0.5 cm.N

### General specifications

Permitted voltage variation at 55 °C maximum temperature is in accordance with IEC 255-1-00 (NFC 45250)	•
Duty factor	100 %
Temperature limits	Use -5 + 60 °C Stored -40 + 80 °C
Test voltages under IEC 255-5, VDE 0435/2021, IEC 536 class 1 (protection against electric shocks)	Voltages ≤ 60 V = 1000 V - Voltages > 60 V = 2000 V
Environmental protection	Tropicalised to IEC 68-2.10 standard
Operating position	Any
Protection IEC 529	IP 10
<i>The installer must ensure adequate guarding (&lt; IP 20)</i>	
Conformity to standards NFC 45 250, IEC 255-1-00, VDE 0435/2021	•
Connection	Motors : to terminal strip Microswitches :
Approvals	W3 blade (6.35) Bureau véritas Bureau véritas - * produced on request - * CSA - * UL * CSA - * UL
Mounting	By 2 screws M4 on Rn 50022 35 mm symmetrical J L DIN rail
Weight	See table page 279

Standard cycle duration

2 s - 24 h

### Types/Features

Number of standard circuits	2 4	88 646 0 88 646 2	88 646 0 88 646 2
Mounting (see dimension)	Base-mounted (1)		—
	—		Panel-mounted (2)

### Program storage medium

Standard To special order To special order



Adjustable cam



Precut cam (with no selector knob)  
On request



Striker cam (strikers supplied with unit)

All 3 types of cam can be fitted to the same timer

### Standard cycle duration

Cycle duration	Gearbox output speed	Cycle duration	Gearbox output speed	Cycle duration	Gearbox output speed
* 2 s	30 rpm	90 s	2/3 rpm	** 1 h	1 rph
* 3 s	20 rpm	2 min	1/2 rpm	** 1 h 30	2/3 rph
* 4 s	15 rpm	3 min	1/3 rpm	** 2 h	1/2 rph
* 6 s	10 rpm	4 min	1/4 rpm	** 3 h	1/3 rph
* 7.5 s	8 rpm	5 min	1/5 rpm	** 4 h	1/4 rph
* 10 s	6 rpm	6 min	1/6 rpm	** 6 h	1/6 rph
* 12 s	5 rpm	10 min	1/10 rpm	** 12 h	1/12 rph
* 15 s	4 rpm	12 min	1/12 rpm	** 24 h	1/24 rph
* 20 s	3 rpm	15 min	1/15 rpm		
30 s	2 rpm	20 min	1/20 rpm		
60 s	1 rpm	30 min	1/30 rpm		

\* For stepping operation please enquire

\*\* At these speeds, allowance must be made for bounce and transition time.

### Direction of rotation

1 or 2 directions (Motor type depends on the number of circuits and the speed, and is selected by the factory)

### Supply voltage

Standard	1 direction - dual-voltage 127 / 220 V 50 Hz 2 directions - single voltage 220 V - 50 Hz
----------	---

### Accessories

Striker cam	79 222 640
Packet of extra strikers	79 222 641
Inverter for DC supply (for a 50 Hz AC motor of the same voltage)	12 V = 24 • 48 V = 110 • 127 V =
Output power max. of 10 VA	84 861 502 84 861 501 84 861 503

### Other information

Timers classed as Standard Products are only available from our distributors. For other voltages and frequencies and DC, please consult us. Basic concepts see page 271. For some typical circuits, see page 284.

## Features

- Motor connections to terminal strip
- Easy adjustment with knob or tool (see page 271)
- Akulon insulation
- Mounting on DIN rail  $\perp$  35 mm symmetrical (EN 50022)

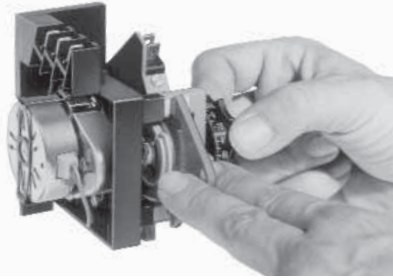

### Internal layout

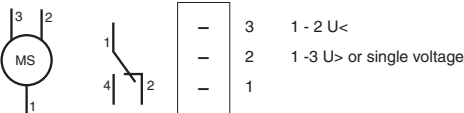

### Microswitch operating curve

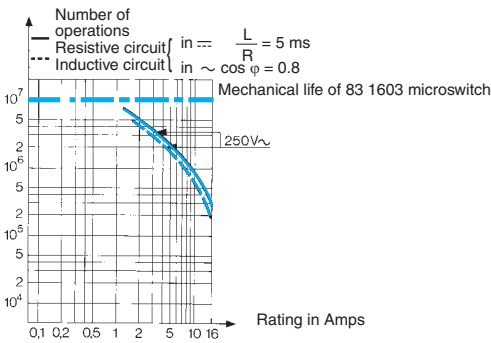

### Diagram

#### Gearmotor options

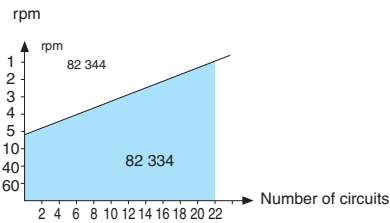

## Dimensions

### Base-mounted

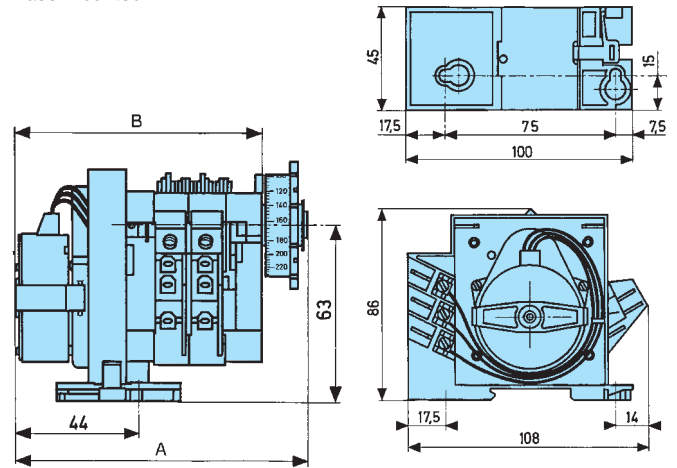

### Fixing from front

#### Details of cut-out and transverse dimensions

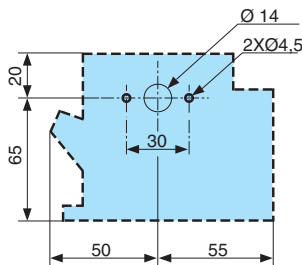

Types	Circuits	Dimension L1		Dimension L1		Weight (g)
		(1)	(2)	(1)	(2)	
<b>88 646 0</b>	2	80	80	95	108	250
<b>88 646 2</b>	4	93	93	108	136	300

## To order, specify:

- 1 Type
- 2 Program storage medium
- 3 Cycle duration
- 4 Direction of rotation
- 5 Supply voltage
- 6 Accessory

Standard products,  
non stocked

Example : Cam timer with external knob 88 645 0 - 7 circuits - Adjustable cams - 60 s - 1 rpm - 127/240 V - 50 Hz - Packet of extra strikers 79 222 641

# Cam timers 88 655 from 1 and 2 circuits

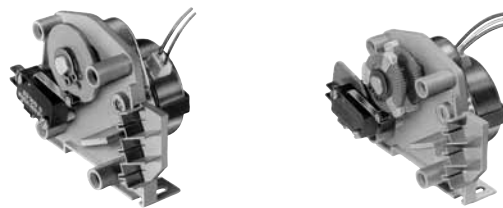

## Characteristics

### Drive device

Type of standard gearmotor depending on number of circuits and speed (see graph)	82 344 0	82 334 5
Max voltage variation	+ 10 - 15 % of Un	+ 10 - 15 % of Un
Absorbed power	3 W	3.5 W
cos φ	0.8	0.4
Transition time	0.7 s	0.4 s
Single direction	1	1
Stopping performance - No. of rotor revs.	1/5	1/5
Number of off-load starts	10 x 10 <sup>6</sup>	2 x 10 <sup>6</sup>
Mechanical strength of gearbox	5 cm. daN	5 cm. daN
Method of gearmotor coupling (to cams)	* By screw	* By screw

\* Friction to special order

### Program storage medium

Cams	with strikers or precut
Minimum space or pulse (electrical)	12° (1/30 cycle duration)
Min. peak between two spaces (electrical)	12° (1/30 cycle duration)
Max. number of spaces per cam	with strikers or precut - 15
Max. switching rate in rotation	30 rpm

### Accuracy

Precision limit error	Precut cam ± 5°
Repeat accuracy	Precut cam ± 0.5°
Selection precision	1° (6° for cam with strikers)

### Output specification

Protected microswitch type	83 160 3
Rating	Nominal 10 A - 250 V Thermal 15 A - 250 V
Mechanical life	10 <sup>7</sup> operations
Resistive torque per circuit	To trip 3 cm.N Tripped 0.5 cm.N

### General specifications

Permitted voltage variation at 55 °C maximum temperature is in accordance with IEC 255-1-00 (NFC 45250)	
Duty factor	100 %
Temperature limits	-5 + 60 °C -40 + 80 °C
Use	Use
Test voltages under IEC 255-5, VDE 0435/2021, IEC 536 class 1 (protection against electric shocks)	Voltages ≤ 60 V = 1000 V - Voltages > 60 V = 2000 V
Environmental protection	Tropicalised to IEC 68-2.10 standard
Operating position	Any
Protection IEC 529	IP 10
<i>The installer must ensure adequate guarding (&lt; IP 20)</i>	
Conformity to standards NFC 45 250, IEC 255-1-00, VDE 0435/2021	
Connection	Leads : 250 mm W3 blade (6.35)
Microswitches	UL (special version) - Veritas test agency (France)
Approvals	By 4 screws M4 on Rn 50022
Mounting	35 mm symmetrical J-L DIN rail
Weight	See table page 281

Standard cycle duration 2 s - 24 h

### Types

Number of standard circuits	1	88 655 1
	2	88 655 2

### Program storage medium

Standard To special order To special order



Adjustable cam



Precut cam (with no selector knob)  
On request



Striker cam (strikers supplied with unit)

All 3 types of cam can be fitted to the same timer

### Standard cycle duration

Cycle duration	Gearbox output speed	Cycle duration	Gearbox output speed	Cycle duration	Gearbox output speed
* 2 s	30 rpm	90 s	2/3 rpm	** 1 h	1 rph
* 3 s	20 rpm	2 min	1/2 rpm	** 1 h 30	2/3 rph
* 4 s	15 rpm	3 min	1/3 rpm	** 2 h	1/2 rph
* 6 s	10 rpm	4 min	1/4 rpm	** 3 h	1/3 rph
* 7.5 s	8 rpm	5 min	1/5 rpm	** 4 h	1/4 rph
* 10 s	6 rpm	6 min	1/6 rpm	** 6 h	1/6 rph
* 12 s	5 rpm	10 min	1/10 rpm	** 12 h	1/12 rph
* 15 s	4 rpm	12 min	1/12 rpm	** 24 h	1/24 rph
* 20 s	3 rpm	15 min	1/15 rpm		
30 s	2 rpm	20 min	1/20 rpm		
60 s	1 rpm	30 min	1/30 rpm		

\* For stepping operation please enquire

\*\* At these speeds, allowance must be made for bounce and transition time.

### Direction of rotation

1 or 2 directions

### Supply voltage

Standard 220 V 50 Hz

### Accessories

Striker cam	79 222 640
Packet of extra strikers	79 222 641
Inverter for DC supply (for a 50 Hz AC motor of the same voltage)	12 V --- 84 861 502 24 • 48 V --- 84 861 501 110 • 127 V --- 84 861 503
Output power max. of 10 VA	

### Other information

Timers classed as Standard Products are only available from our distributors. For other voltages and frequencies and DC, please consult us. Basic concepts see page 271. For some typical circuits, see page 284.



## Features

- Insulating support

### Internal layout

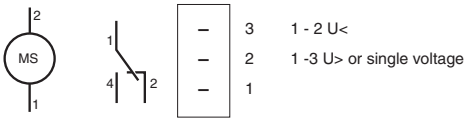

### Microswitch operating curve

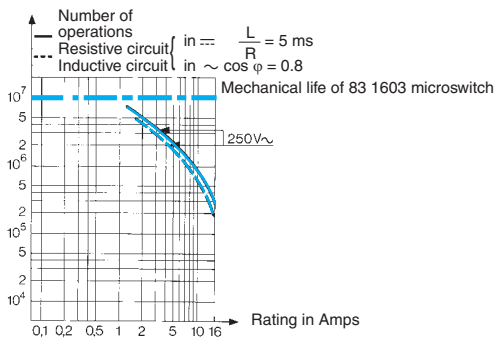

### Diagram

Gearmotor options

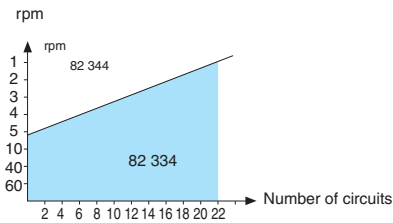

## Dimensions

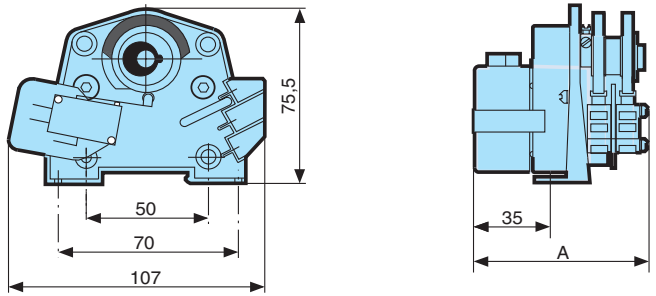

Types	Circuits	Dimension A*	Weight
88 655 1	1	54	210
88 655 2	2	74	230

\* For fitting with motor 82 334 5  
with motor 82 344 0 take off 6 mm

## To order, specify:

- 1** Type
- 2** Program storage medium
- 3** Cycle duration
- 4** Direction of rotation
- 5** Supply voltage
- 6** Accessory

Standard products,  
non stocked

Example : Cam timer 88 655 1 - Adjustable cams - 60 s - 1 rpm - 220 V - 50 Hz - Packet of extra strikers 79 222 641

# Cam timers 88 256 from 1 to 3 circuits

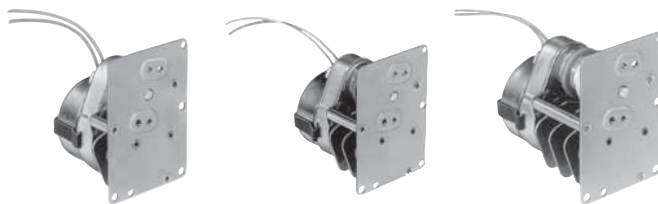

Standard cycle duration 2 s - 24 h

## Types

Number of standard circuits	1	<b>88 256 4</b>
	2	<b>88 256 5</b>
	3	<b>88 256 9</b>

## Program storage medium



Precut cams

## Standard cycle duration

Cycle duration	Gearbox output speed	Cycle duration	Gearbox output speed
60 s	1 rpm	** 1 h	1 rph
5 min	1/5 rpm	** 2 h	1/2 rph
15 min	1/15 rpm	** 5 h	1/5 rph
30 min	1/30 rpm	** 15 h	1/15 rph
		** 30 h	1/30 rph

\*\* At these speeds, allowance must be made for bounce and transition time.

## Direction of rotation

1 or 2 directions (standard clockwise)

## Supply voltage

Standard 220 V - 50 Hz

## Accessories

Inverter for DC supply	12 V $\equiv$	<b>84 861 502</b>
(for a 50 Hz AC motor of the same voltage)	24 • 48 V $\equiv$	<b>84 861 501</b>
	110 • 127 V $\equiv$	<b>84 861 503</b>

Output power max. of 10 VA

## Characteristics

### Drive device

Type of standard gearmotor	82 344 0
Absorbed power	3 W
Motor output	0.16 W
Max. heating-up	50 °C
Number of off-load starts	10 • 10 <sup>6</sup>
Maximum permitted torque from gearmotor under continuous conditions	0.5 N.m
Method of gearmotor coupling (to cams)	Rigid • Friction to special order •

### Program storage medium

Precut cam	•
Minimum space or pulse (electrical) (* cycle duration)	21 ° - 1/17 *
Min. peak between two spaces (electrical) (* cycle duration)	9 ° - 1.5/60 *
Max. number of spaces per precut cam	12
Max. switching rate in rotation (limit on number of circuits) see resistive torque	1 rpm

### Accuracy

Precision limit error : precut cam (* Factory)	± 3.5 °
--	---------

### Output specification

Protected microswitch type	83 160 0
Rating	Nominal 16 A - 250 V ~ Thermal 20 A - 250 V $\equiv$
Mechanical life (operations)	10 <sup>7</sup>
Resistive torque per circuit	To trip 0.06 N.m Tripped 0.01 N.m

### General specifications

Permitted voltage variation at 55 °C maximum temperature is in accordance with IEC 255-1-00 (NFC 45250)	•
Duty factor	100 %
Temperature limits	Use +5 +60 °C Stored -40 +80 °C
Test voltages under IEC 255-5, VDE 0435/2021, IEC 536 class 1 (protection against electric shocks)	≤ 60 V = 1000 V ≥ 60 V = 2000 V
Environmental protection	Protected metal components Insulated motor coil
Operating position	Any
Protection IEC 529	IP 10
<i>The installer must ensure adequate guarding (&lt; IP 20)</i>	
Connection	Motors Leads 250 mm Microswitches W3 blade (6.35)
Mounting	By screw 2xM3 - 2xM4
Weight	See table page 283

## Other information

Timers classed as Standard Products are only available from our distributors.  
For other voltages and frequencies and DC, please consult us.  
Basic concepts see page 271.  
For some typical circuits, see page 284.

### Internal layout

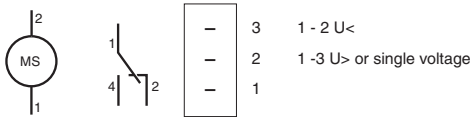

### Microswitch operating curve

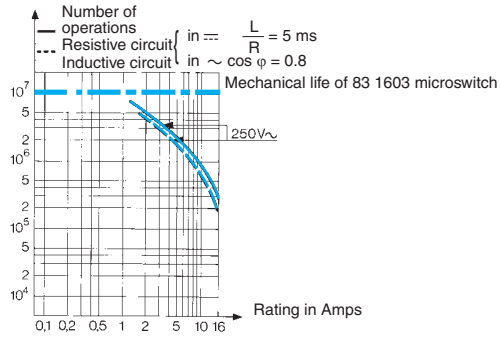

### Dimensions

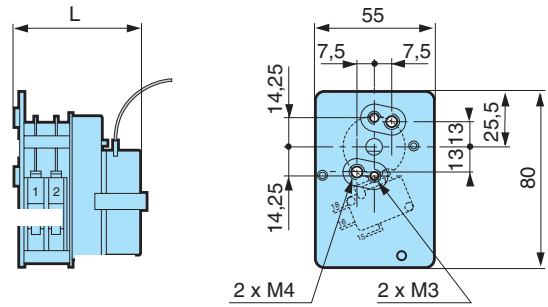

Types	L (mm)	Weight (g)
<b>88 256 4</b>	52	200
<b>88 256 5</b>	63.5	220
<b>88 256 9</b>	74	240

### Diagram

#### Gearmotor options

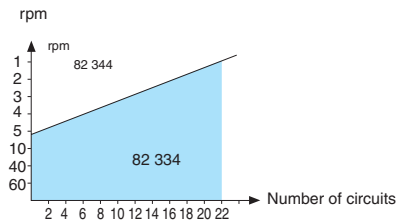

### To order, specify:

- 1** Type
- 2** Program storage medium
- 3** Cycle duration
- 4** Direction of rotation
- 5** Supply voltage
- 6** Accessory

Standard products, non stocked

Example : Cam timer 88 256 4 - Precut cam - 60 s - 1 rpm - 1 direction - 220 V - 50 Hz - Inverter 84 861 502

# Some typical circuits

## One speed of rotation

### Continuous rotation or advance

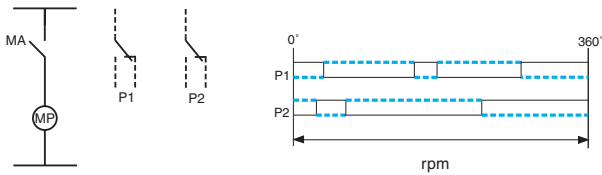

MA = On/off switch  
MP = Timer motor  
P1, P2 etc. = Timer contacts

### Single cycle, start at pulse

#### Short cycle

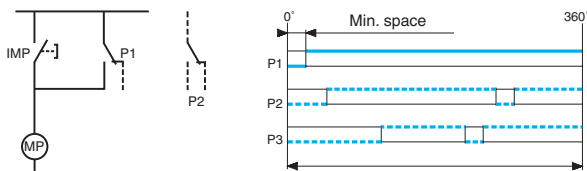

IMP = Push button to start cycle  
MP = Timer motor  
P1, P2 = Timer contacts

$$\frac{\text{rpm} \times \text{min. space}}{360^\circ} < \text{pulse} < 1 \text{ step}$$

#### Long cycle

In the above case, the minimum length of pulse required may be prohibitive. The circuit shown below cuts this minimum length to the pull-in time of the relay.

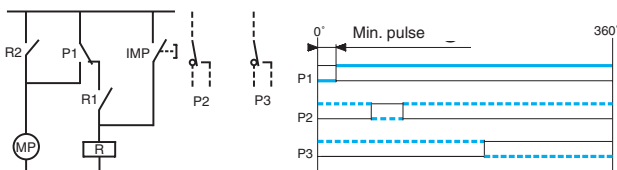

IMP = Starting push button  
R = Relay coil  
R1, R2 = Relay contacts  
MP = Timer motor  
P1, P2 = Timer contacts

#### Note: We do not supply the relay

Pulse from IMP  
R1, R2 change over  
R maintains own supply during space at P1

### Single cycle, started by maintained contact

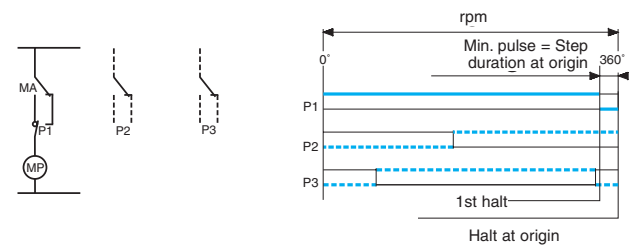

MA = On/off switch  
MP = Timer motor  
P1, P2 etc. = Timer contacts  
1st changeover of MA = Start of cycle  
changeover of P1 = End of cycle  
2nd changeover of MA = Return to origin

**N.B. :** Time for 2nd changeover of MA

$$> \frac{\text{min space} \times \text{rpm}}{360^\circ}$$

### Sequenced step by step

#### By pulse

The layout is identical to that shown for 2 with or without relays. The contour of cam 1 will set the desired number of steps.

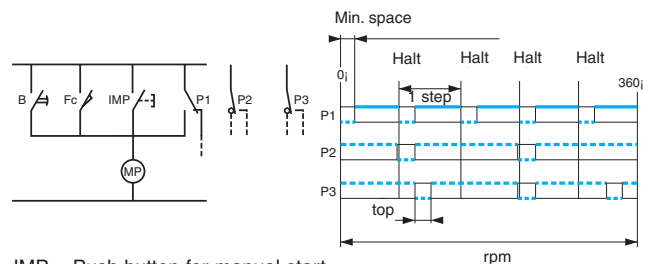

IMP = Push button for manual start  
Fc = Limit switch  
B = Timed contact  
MP = Timer motor  
P1, P2, P3 = Timer contacts

$$\frac{\text{min. space} \times \text{rpm}}{360^\circ} < \text{pulse} < 1 \text{ step}$$

The load circuits change over either at the halt positions (e.g. P2), or during the movement through a step thus setting the output pulses as a function of the size of the space and the duration of the cycle (e.g. P3). Other contacts can be connected in parallel with IMP and each pulse will then cause a fresh step.

**Typical applications :** sequenced control of machine-tools, complex automatic cycles, preselection impulse counters with fixed or multiple settings

**N.B. :** consult us for sequenced step by step operation or for using microswitches as changeover switches

# Some typical circuits

## By maintained contact

The cam profile will determine the number of steps as shown in diagram 3.

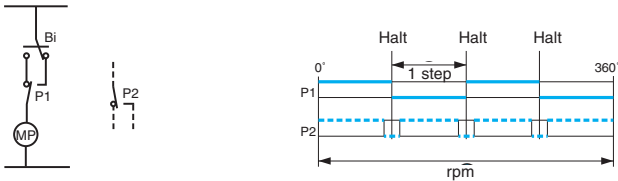

Bi = two-position actuating contact

MP = timer motor

P1, P2 etc. = timer contacts

1st changeover of Bi = advance by one step, P1 changes over

2nd changeover of Bi = advance by one step, P1 changes over

Changeover time of Bi = > 1 step

## Intermittent advance controlled by external time-base

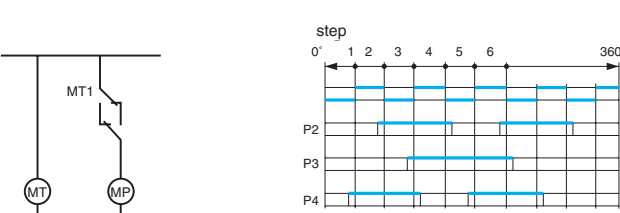

MT = Time-base motor

MP = Timer motor

## Continuous rotation in both directions

### Continuous rotation in forward or reverse

#### Example :

Program which follows a step by step rise and return cycle (symmetrical) in one direction and a continuous return in the other, etc.

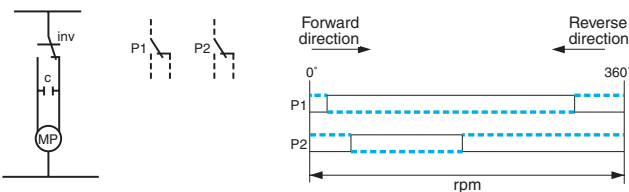

### Continuous single-cycle rotation in forward or reverse direction

#### Example :

Successive start-up of pumps or compressors with shutdown in reverse order. Start position can be returned to in course of rotation.

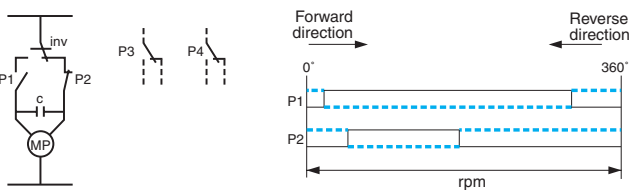

Inv - Direction changer

MP = Reversible motor 82 470

C = Timer capacitor

P1, P2 = Timer contacts

## Two speeds of rotation

As in the case of the basic units, the low-speed motor can be connected for:

- continuous cycling
- single cycles
- stepping action.

The presence of the high-speed motor increases the options available by allowing:

- automatic or controlled fast cycle-end
- reset to origin after power failure
- two-speed stepping action
- two-speed continuous cycling.

### Controlled fast cycle-end with halt at origin

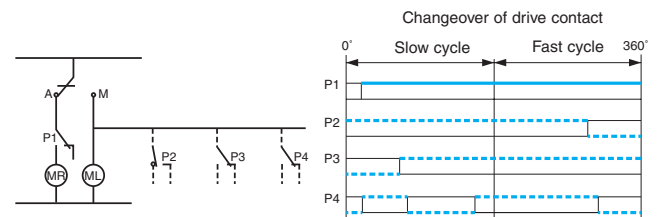

ML = low-speed motor

MR = high-speed motor

M.A. to M = motor ML turns

M.A. to A = motor MR fed from P1, fast reset to origin

### Single-cycle timer - fast cycle-end after voltage off or deliberate halt

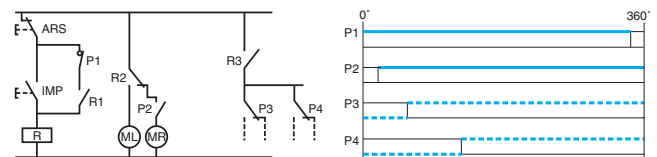

R = relay coil

R1, R2, R3 = relay contacts

ARS = Safety stop-switch

IMP = Start

ML = Low-speed motor

MR = High-speed motor

P1, P2, etc. = Timer contacts

Pulse from IMP - R provides own supply via R1, P1

ML switched on by R2, supply to P3, P4 via R3

Changeover of P1 = End of cycle Voltage off; R1, R2 and R3 change over

Voltage comes back on - supply to MR via P1 and P2; when P1 changes over, supply fed to ML

**Continuous cycling timer - fast cycle-end after voltage off and cycle resumed at slow constant speed**

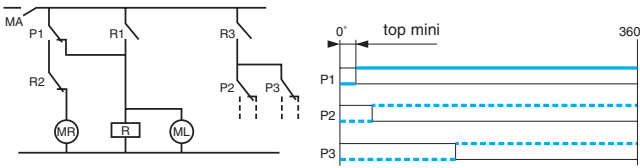

When MA closes, R1, R2 & R3 change over - there is supply to ML so P1 changes over.  
 Voltage off - R1, R2 & R3 change over  
 Voltage back on - MR is supplied via P1 and P2 - when P1 changes over, there is supply to ML

**Single-cycle timer, halt in intermediate position, fast cycle-end after voltage off and cycle resumed at slow speed**

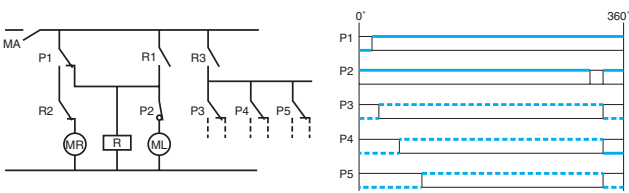

Same operation as in example 3 - ML turns until P2 changes over. There are other possible layouts, please consult us.

**Important note :**

These circuits require one or more control circuits (P1, P2). In your order, be sure to state the total number of control circuits used.

**Reducing the minimum opening or closing time of contacts**

A single minimum time which is too short during a program may sometimes prevent a timer from being used. A special circuit allows this problem to be overcome.



**Example :**

The minimum time normally obtainable with a standard cut-out is 1/60th of the total duration of the cycle, i.e. 1 second.

**Closure of a contact**

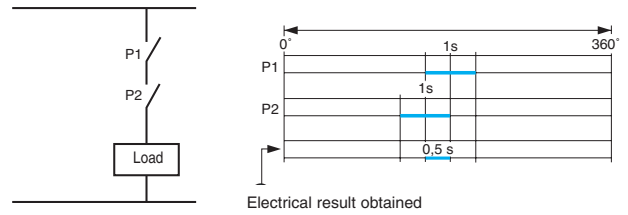

Circuit : a second contact, connected in series with the first, closes out of synchronisation with the first. There is only a supply to the load circuit while both contacts are closed.

**Opening of a contact**

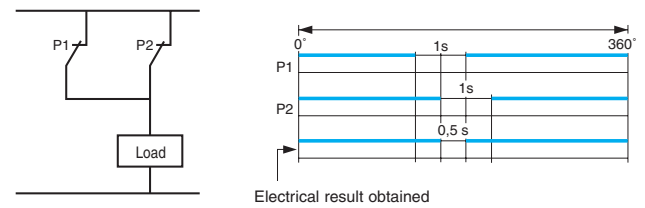

These circuits, which can be used with all timers, allow the minimum time interval to be reduced by approximately half.

**N.B. :** These two circuits can only be obtained with adjustable cams.













# Machine safety

Machine safety





Functions	Level of safety	Output contacts		Supply voltage	Casing	Connection	Designation	
		Safety contacts	Data contacts					
<ul style="list-style-type: none"> <li>Emergency stop</li> <li>Mobile guard monitoring</li> </ul>	3	3	1	24 VAC/DC	22.5 mm	Screw terminals	KNA3 XS	<b>Page 294</b>  <b>KNA3 XS</b>
	4			40 to 60 VAC		Spring terminals	KNAC3 XS	
				24 VAC/DC	Screw terminals	KZP3 RS		
				40 to 60 VAC/DC	Spring terminals	KNAC3 XS		
				115 VAC	Screw terminals	KNA3 RS		
	230 VAC			Spring terminals	KNAC3 XS			
<ul style="list-style-type: none"> <li>2-hand control</li> </ul>	4	3	1	24 VAC/DC	45 mm	Screw terminals	KZH3 RS	<b>Page 306</b>  <b>KZH3 RS</b>
				115 VAC				
				230 VAC				
<ul style="list-style-type: none"> <li>Timed contacts</li> <li>Emergency stop</li> <li>Mobile guard monitoring</li> </ul>	3	1 instantaneous 2 timed	1 timed	24 VAC/DC	45 mm	Screw terminals	KZR3 RS	<b>Page 300</b>  <b>KSW2 RS</b>
				24 VAC/DC				
<ul style="list-style-type: none"> <li>Zero speed monitoring of a motor</li> </ul>	4	2	0	24 VAC/DC	45 mm	Screw terminals	KSW2 RS	<b>Page 304</b>  <b>KSW2 RS</b>
<ul style="list-style-type: none"> <li>Extension of number of contacts for safety relays</li> </ul>	Depending on main relay	3	0	24 VAC/DC	22.5 mm	Spring terminals	KZEC3 XS	<b>Page 302</b>  <b>KZHNV XS</b>
				40 to 260 VAC/DC		Screw terminals	KZE3 XS	
				40 to 260 VAC		Spring terminals	KZEC3 XS	
Screw terminals	KZE3 XS							
<ul style="list-style-type: none"> <li>Relevelling zone control</li> </ul>	4	2	1	24 VAC/DC	22.5 mm	Screw terminals	KZHNV XS	<b>Page 298</b>  <b>KZHNV XS</b>

## Conformity

European "Machinery" Directive 89/392/EEC	•
French Decree 92/765-766-768	•
European "Usage" Directive 89/655/EEC	•
French Decree 93-40 / 93-41	•
European "EMC" Directive 89 336/EEC	•
IEC 61496-1	•
IEC 664-1	•
EN 50081-2	•
EN 50082-2	•
EN 60204-1	•
EN 292-1 and 2	•
EN 574 / 97	• Type III C (KZH2-XS and KZH3-RS)
EN 954-1	•
EN 418	•
EN 1088	•
UL 508	• UL
C22-2 No. 14-M91	• (C) UL
GS-ET-20	• BG

## Harmonised European standards

These standards have been developed to enable designers, manufacturers or any other person to interpret the essential requirements of the directives in order to ensure conformity with European law.

The standards are designed as a framework and general guide for producing machines which will be safe under normal operating conditions

### → Main harmonised standards relating to safety

<b>EN 98/37</b>	Machine safety Basic concepts General design principles	<b>EN 418</b>	Machine safety Emergency stop equipment Functional aspects
<b>EN 60 204-1</b>	Machine safety Electrical machine equipment	<b>EN 1088</b>	Machine safety Latching and interlocking mechanisms Mobile guards
<b>EN 954-1</b>	Machine safety Parts of control systems relating to safety Tables of risks and categories	<b>EN 574</b>	Machine safety 2-hand control device

## Safety category for control systems (according to EN 954-1)

Categories	Summary of requirements	System behaviour	Main basis of safety
<b>B</b>	The part of the machine control system relating to safety and/or protective devices, as well as its components, must be designed, selected, assembled and combined using the most advanced methods in order to be able to cope with expected influences.	- If a fault occurs, it may cause the loss of the safety function. - Certain faults are not detected.	<b>By selecting components and safety principles</b>
<b>1</b>	The requirements of B apply. Proven components and safety principles must be used.	As described for category B, but with greater reliability in relation to the safety of the safety function.	
<b>2</b>	The requirements of B and the use of proven safety principles apply. The safety function must be <b>checked at suitable intervals</b> by the machine control system. <b>Note</b> : suitable times will depend on the application and the type of machine.	- The appearance of a fault may cause the loss of the safety function between checking intervals. - <b>the fault is detected by the check.</b>	<b>By structure</b>
<b>3</b>	The control system must be designed so that : a) a <b>single fault</b> in control does not cause the loss of the safety function. b) if reasonably possible, the single fault must be detected by suitable measures using the most advanced technology.	- When there is a single fault, the safety function continues to operate. - <b>Certain faults are detected, but not all.</b> - The accumulation of non-detected faults may lead to the loss of the safety function.	
<b>4</b>	The requirements of B and the use of proven safety principles apply. The control system must be designed so that : a) a single fault in control does not cause the loss of the safety function, and b) if possible, the single fault should be detected, by the next call to the safety function, or c) if b) is not possible, an accumulation of faults should not cause the loss of the safety function.	- <b>When faults appear, the safety function continues to operate.</b> - Faults will be detected in time to avoid the loss of the safety function.	

## Estimation of the risk in the event of a fault and selection of a suitable category (according to EN 954-1)

Starting point for estimating the risk for the part of the control system relating to safety.

**S Seriousness of injury**  
S1 Slight injury  
S2 Serious, irreversible injury to one or more person(s) or death

**F Frequency and duration of exposure**  
F1 Rare to quite frequent  
F2 Frequent to continuous

**P Possibility of avoiding the dangerous phenomenon**  
P1 Possible under certain conditions  
P2 Rarely possible

**B. 1-4** : Categories for the parts of the control system relating to safety

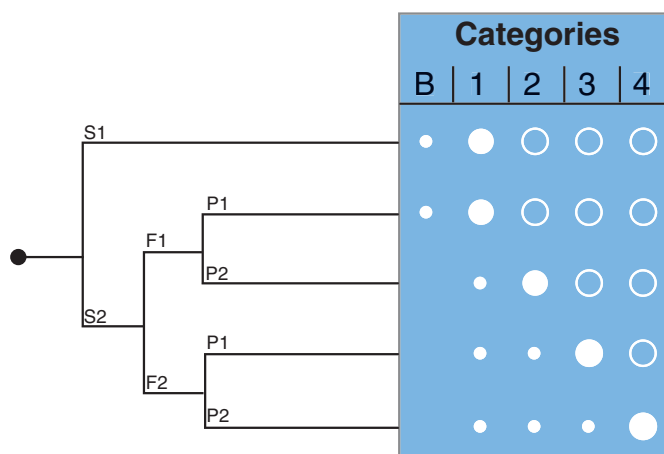

- Normal category for the level of risk
- Go to the next highest category if the solution is standardised
- Go to the next lowest category if the solution is standardised

# Safety relay

## → Emergency stop

### KNA3-XS / KNA3-RS / KZP3-RS

- "Emergency stop" and "mobile guard monitoring" functions
- Control device with one or two channels
- 3 "N/O" safety contacts with linked contacts 6A / 250 AC
- 1 "N/C" signalling contact
- Level 4 according to NF.EN 954-1
- KNA3-RS (45 mm)
  - Integrity check on control devices
  - Separate return loop
- KZP3-RS (45 mm)
  - Four input circuits



### Specifications

Type	Supply voltage	Connections	Weight (g)	Code
KNA3-XS	24 V AC/DC	Screw terminals	310	85 100 036
	40 - 260 V AC	Screw terminals	310	85 100 037
KNAC3-XS	24 V AC/DC	Spring terminals	310	85 101 036
	40 - 260 V AC	Spring terminals	310	85 101 037
KNA3-RS	24 V AC/DC	Screw terminals	310	85 100 436
	115 V AC	Screw terminals	410	85 100 434
	230 V AC	Screw terminals	410	85 100 435
KZP3-RS	24 V AC/DC	Screw terminals	410	85 100 536

### General characteristics

Operating range -15 % / + 10 % of Un for AC  
-15 % / + 15 % of Un for DC

#### Precision

Reset time < 25 ms  
Maximum response time on emergency stop < 50 ms

#### Output specification

Number of safety circuits 3 "N/O" AgSnO2 contacts  
Number of data circuits 1 "NC" AgSnO2 contacts

#### Function and use

Max. absorbed power KNA3-XS / KNA3-RS : AC 1.6 VA / DC 2 W  
KZP3-RS : AC 3 VA / DC 3 W

Dielectric strength 2.95 kV according to CEI 664-1  
Resistance to tracking Material group III

#### EMC immunity according to EN 50082-2

Radiated electromagnetic field 80 MHz to 1 GHz/900 MHz (ENV 50140/204)  
KNA3-XS : 10 V/m Level 3 acc. to IEC 1000.4.3  
KNA3-RS/KZP3-RS : 30 V/m Level X acc. to IEC 1000.4.3

Electrostatic discharge 8 kV in the air acc. to IEC 1000.4.2  
KNA3-RS / KZP3-RS : 15 kV in the air acc. to IEC 1000.4.2

Shock waves KNA3-XS :  
- Common mode 1 kV acc. to IEC 1000.4.5 KNA3-RS / KZP3-RS :  
- Level 3 acc. to IEC 1000.4.5  
- Common mode 2kV for 24 V and 24 V  
- Common mode 4 kV for 230 V (2 kV residual current mode for KNA3-RS)

Radio frequencies in common mode KNA3-XS :  
- 10 V rms Level 3 according to IEC 1000.4.6  
- 150 KhZ TO 80 MHz (ENV 50141) according to IEC 1000.4.11  
KNA3-RS / KZP3-RS :  
- 30 Vrms Level X acc. to IEC 1000.4.6  
150 kHz to 80 MHz (ENV 50141) according to IEC 1000.4.11

## Dimensions

### KNA3-XS

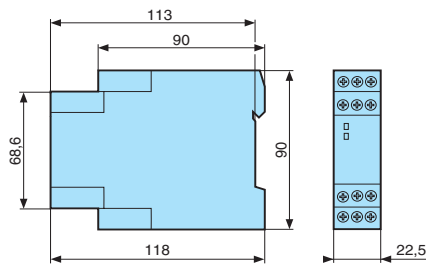

### Mounting - Removing

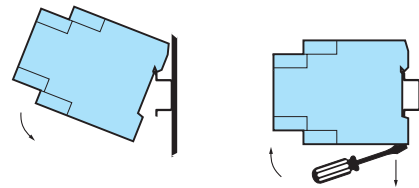

### KNA3-RS / KZP3-RS

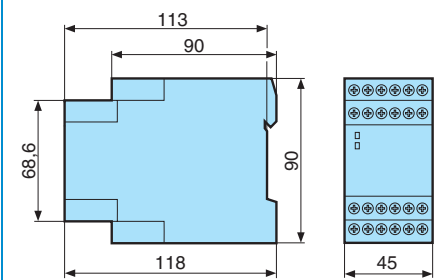

## Connections

### KNA3-XS

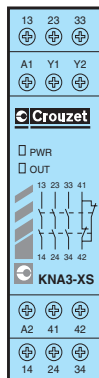

A1-A2 Power supply Control device (s)  
Y1-Y2 Start / validation  
13-14/23-24/33-34 "N/O" safety contacts  
41-42 "N/C" signalling contacts

### KNA3-RS

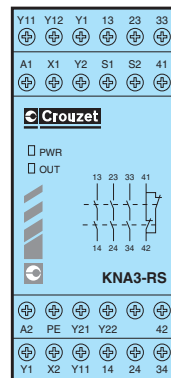

A1-A2 Power supply  
Y11-Y12 / Y21-Y22 Redundant inputs with differentiated voltage for control devices  
Y1-Y2 Start/validation  
S1-S2 Short-circuit protection on start / validation input  
X1-X2 Return loop  
13-14/23-24/33-34 "N/O" safety contacts  
41-42 "N/C" signalling contacts

### KZP3-RS

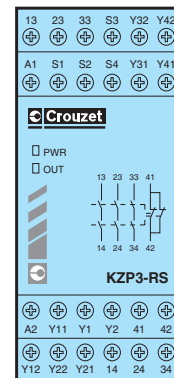

A1-A2 Power supply  
Y11-Y12 / Y21-Y22 Redundant inputs with differentiated voltage for control devices  
Y31-Y32 / T41-T42 Redundant inputs with differentiated voltage for control devices  
Y1-Y2 Start/validation  
S1-S2 / S3-S4 Short-circuit protection on start/validation input  
13-14/23-24/33-34 "N/O" safety contacts  
41-42 "N/C" signalling contacts

## Principles

### Control devices :

The KZP3-RS is used to obtain and maintain a category 4 level of safety for an installation with two control devices.

Depending on the degree of safety required, KNA3-XS / KNA3-RS / KZP3-RS can receive the following components as inputs :

- pushbutton for start or validation (Y1-Y2)
- emergency stop pushbuttons with
  - one or two contacts (A1-A2)
  - two contacts KNA3-RS : Y11-Y12 and Y21-Y22,
  - two contacts KZP3-RS : Y11-Y12 / Y21-Y22 and Y31-Y32 / Y41-Y42
- position sensors (limit switches) with
  - one or two contacts (A1-A2)
  - two contacts KNA3-RS : Y11-Y12 and Y21-Y22,
  - two contacts KZP3-RS : Y11-Y12 / Y21-Y22 and Y31-Y32 / Y41-Y42

A positive break operation device must be used if a single channel is used.

To increase the degree of safety, one "N/C" auxiliary contact per power contactor is wired in series with the start (or validation) pushbutton, to ensure self-checking in this part of the installation.

### Control devices :

The KNA3 / KZP3 has three "N/O" safety contacts (13-14/23-24/33-34) and one "N/C" signalling contact (41-42). One or more control devices may be wired up to the breaking capacity of the safety contacts : 1500 VA. However, to limit internal heating, it is advisable not to exceed 10 A thermal for all three contacts. The signalling contact can be wired on a PLC input or integrated into a fault signalling system.

### Extending the number of contacts :

The number of contacts can be extended and the breaking capacity thus increased. To do this, use the KZE3-XS.

## Applications

**KNA3-XS**  
Category 2

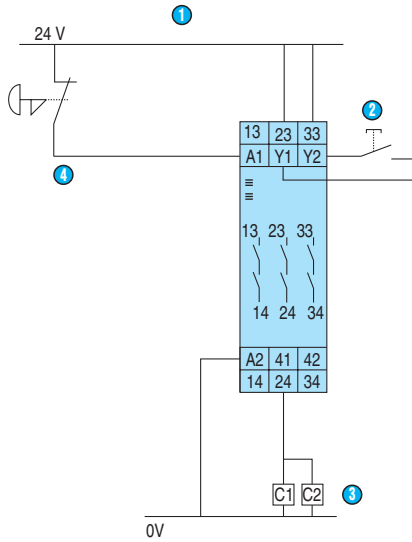

- ① Control device with one channel without return loop
- ② Validation
- ③ Two coils per contact
- ④ Emergency stop

**KNA3-XS**  
Category 3

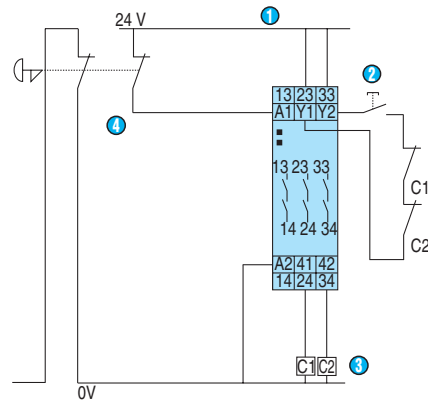

- ① Control channel with 2 channels with return loop
- ② Validation
- ③ One coil per contact
- ④ Emergency stop

**KNA3-RS**  
Category 4

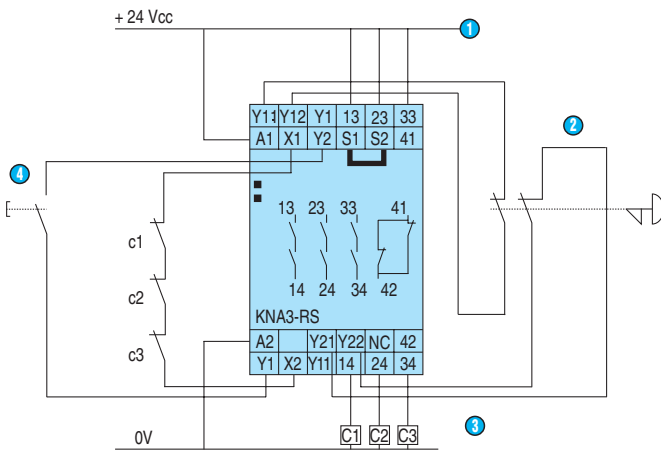

- ① S1 and S2 bridged for start/validation input protection
- ② Emergency stop
- ③ 41-42 to PLC or fault circuit
- ④ Start

**KNA3-RS**  
Category 2

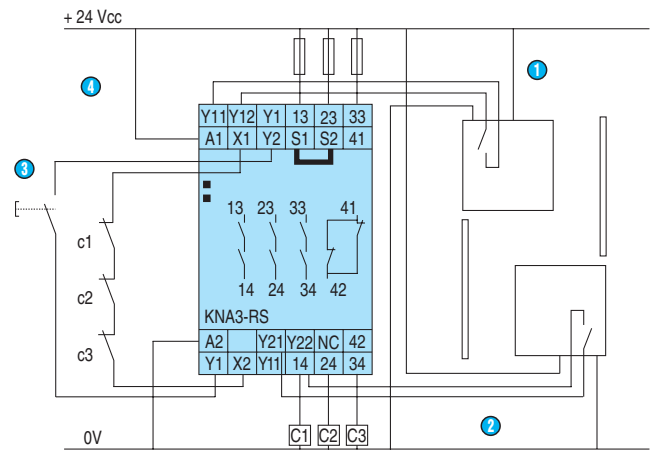

- ① "Light on" reflex cells
- ② 41-42 to PLC or fault circuit
- ③ Start
- ④ Compulsory : S1 and S2 bridged for start/validation input protection



### Level 4 - KZP3-RS

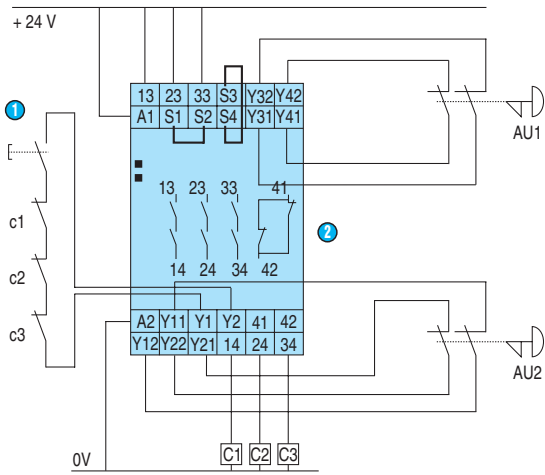

- 1 Start
- 2 S1-S2 and S3-S4 bridged for start/validation input protection

### Level 4 - KZP3-RS

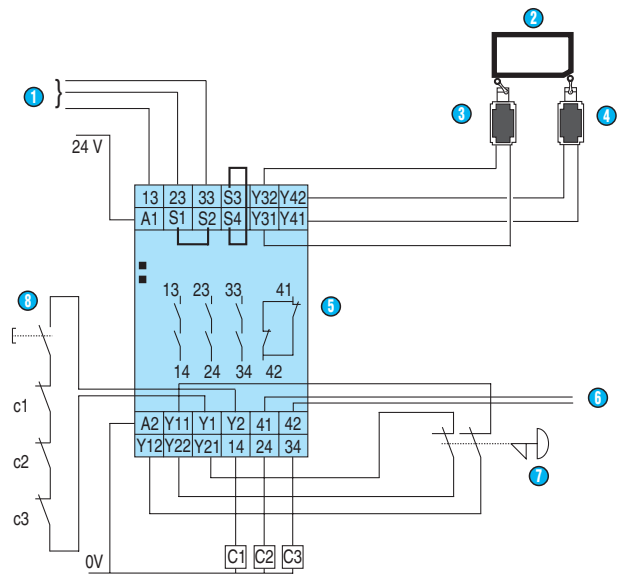

- 1 PLC outputs
- 2 NO
- 3 Cover
- 4 NF
- 5 S1-S2 and S3-S4 bridged for short-circuit protection on the validation line
- 6 PLC input
- 7 Include an "N/C" contact from each power contactor in the start/validation line (return loop)
- 8 Start

# Safety relay

## → Releveling zone check

- "Releveling zone check" functions conforming to EN 81
- Control device with two channels
- 2 "N/O" safety contacts with linked contacts 6A/250 V AC
- 1 "N/C" signalling contact-1A
- Level 4 according to NF.EN 954-1



### Specifications

Type	Supply voltage	Connections	Weight (g)	Code
KZHNV-XS	24 V AC DC	Screw terminal	230	85 100 526

### General characteristics

#### Supply

Operating range	-15 % / + 10 % of Un for AC -15 % / + 15 % of Un for DC
-----------------	--

#### Precision

Synchronisation difference	< 500 ms
Response time on release of control device	< 50 ms

#### Output specification

Number of safety circuits	2 "N/O" AgSnO 2 contacts
Number of data circuits	1 "N/C" AgSnO 2 contacts

#### Function and use

Max. absorbed power	1.5 VA - 24 V AC / 1.5 W - 24 V DC
Dielectric strength	2.95 kV according to IEC 664-1
Resistance to tracking	Material group III

#### EMC immunity according to EN 50082-2

Radiated electromagnetic field	30 V/m Level X acc. to IEC 1000.4.3 80 Mhz to 1 Ghz (ENV 50140/204)
Electrostatic discharge	15 kV in the air (CEI 1000.4.2)
Shock waves	Level 3 (IEC 1000.4.5) Common mode 2 kV for 24 V DC and 24 V AC
Radio frequencies in common mode	10 Vrms on inputs / Level 3 (IEC 1000.4.6) 30 Vrms on supp. / Level X (IEC 1000.4.6) 150 kHz to 80 Mhz (ENV 50141) acc. to IEC 1000.4.11

### Dimensions

#### KZHNV-XS

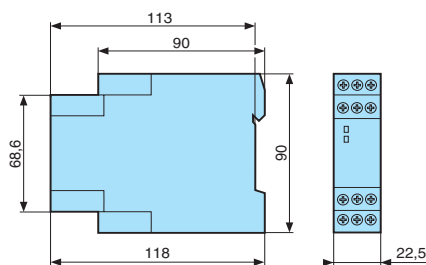

#### Mounting - Removing

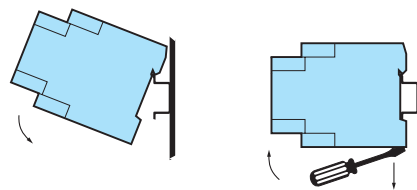

## Connections

### KZHNV-XS



A1-A2 Power supply  
 Y11-Y12 / Y21-Y22 Redundant inputs with  
 differentiated voltage for control devices  
 13-14/23-24 "N/O" safety contacts  
 41-42 "N/C" signalling contacts

## Applications

### KZHNV-XS

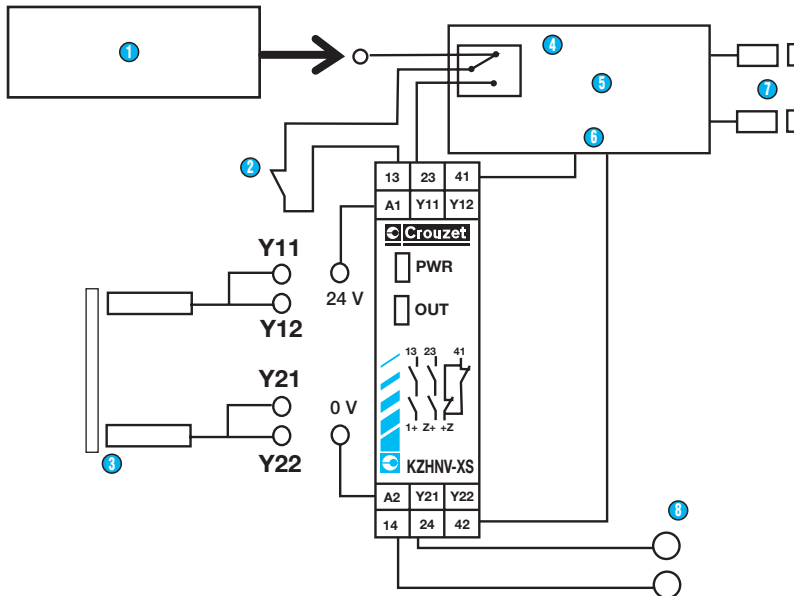

- ① Turn-off information from the enable relay
- ② High speed contactor turn-off contact (optional)
- ③ Relevelling zone
- ④ Enable
- ⑤ Electronic client card
- ⑥ Check state of safety relay
- ⑦ Level sensors
- ⑧ Door safety line shunt

# Safety relay

## → Timed contacts

- "Emergency stop" and "mobile guard monitoring" functions
- Safety timer function from 0.5 s to 30 s
- Integrity check on control devices
- 1 "N/O" instantaneous safety contact with linked contacts-6A/250 V AC
- 1 "N/O" timed safety contact with linked contacts - 6A/250 V AC
- 1 "N/C" timed safety contact with linked contacts-6A/250 V AC
- 1 "N/C" timed signalling contact
- Level 4 according to NF.EN 954-1



### Specifications

Type	Supply voltage	Connections	Weight (g)	Code
KZR3-RS	24 V AC DC	Spring terminals	410	85 100 736

### General characteristics

#### Supply

Operating range	- 15 % / + 10 % of Un for AC - 15 % / + 15 % of Un for DC
-----------------	--

#### Precision

Reset time	< 25 ms
Maximum response time on emergency stop	< 50 ms

#### Output specification

Number of safety circuits	instantaneous : 1 "NO" AgSnO <sup>2</sup> timed : 1 "N/O" + 1 "NC" AgSnO <sup>2</sup> contact
Number of data circuits	1 "NC" AgSnO <sup>2</sup> contact

#### Function and use

Absorbed power	AC 1.6 VA / DC 2 W
Dielectric strength	2,95 kV according to IEC 664-1
Resistance to tracking	Material group III

#### EMC immunity according to EN 50082-2

Radiated electromagnetic field	30 V/m Level X acc. to IEC 1000.4.3 80 MHz to 1 GHz / 900 MHz (ENV 50140/204)
Electrostatic discharge	15 kV in the air acc. to IEC 1000.4.2.
Shock waves	Level 3 acc. to IEC 1000.4.5 Common mode 4 kV for 230 V AC Common mode 2 kV for 24 V DC and 24 V AC
Radio frequencies in common mode	30 V rms Level X acc. to IEC 1000.4.3 150 kHz to 80 MHz (ENV 50141) acc. to IEC 1000.4.11

### Dimensions

#### KZR3-RS

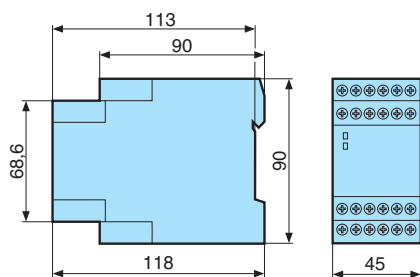

#### Mounting - Removing

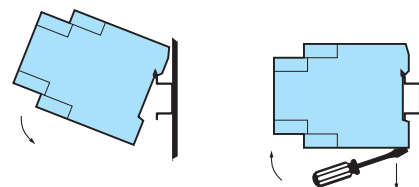

## Connections

### KZR3-RS

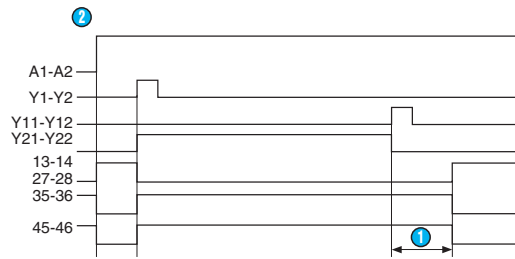
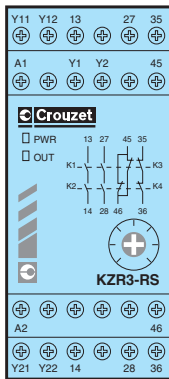

- A1-A2 Power supply
- Y11-Y12 / Y21-Y22 Redundant inputs with differentiated voltage for control devices
- Y1-Y2 Start/validation
- 13-14 "N/O" instantaneous safety contact
- 23-24 "N/O" timed safety contact
- 31-32 "N/C" timed safety contact
- 41-42 "N/C" timed data contact

- 1 Timed
- 2 Power-up

## Principles

### Control devices :

Depending on the degree of safety required, KZR3-RS can receive the following components as inputs :

- emergency stop pushbuttons with two contacts (Y11-Y12 and Y21-Y22)
  - position sensors (limit switches) with one or two contacts (Y11-Y12 and Y21-Y22)
  - auxiliary contact for electromagnetic lock (Y11-Y12 and Y21-Y22)
  - pushbutton for start or validation (Y1-Y2)
- A positive break operation device must be used if a single contact is used.

### Control devices :

The KZR3-RS has one "N/O" instantaneous safety category 4 contact (13-14) , one "N/O" timed safety category 3 contact (23-24) and one "N/C" (41-42) signalling contact. One or more control devices may be wired up to the breaking capacity of the safety contacts : 1500 VA.

### Extending the number of contacts :

The number of contacts of the KZR3-RS can be extended and the breaking capacity thus increased. To do this, use the KZE3-RS.

## Applications

### KZR3-RS used for deferred access

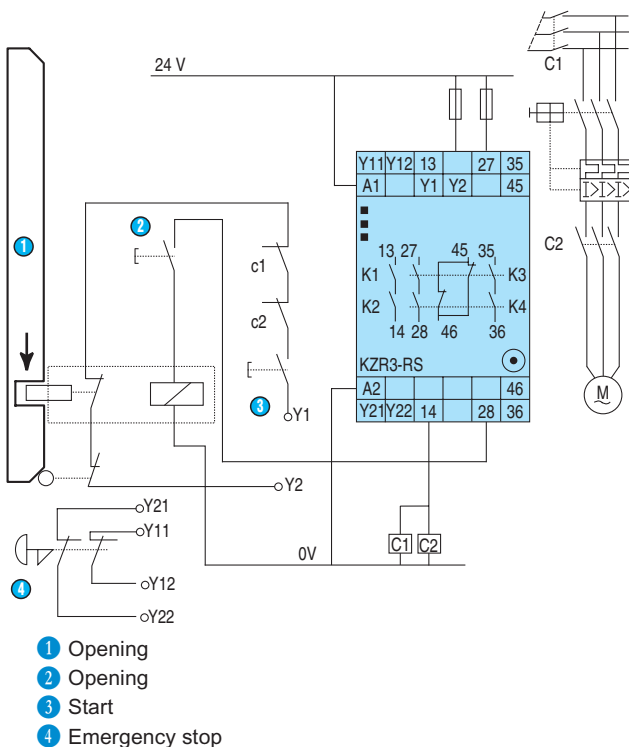

### KZR3-RS used for breaking M1 and M2 in sequence

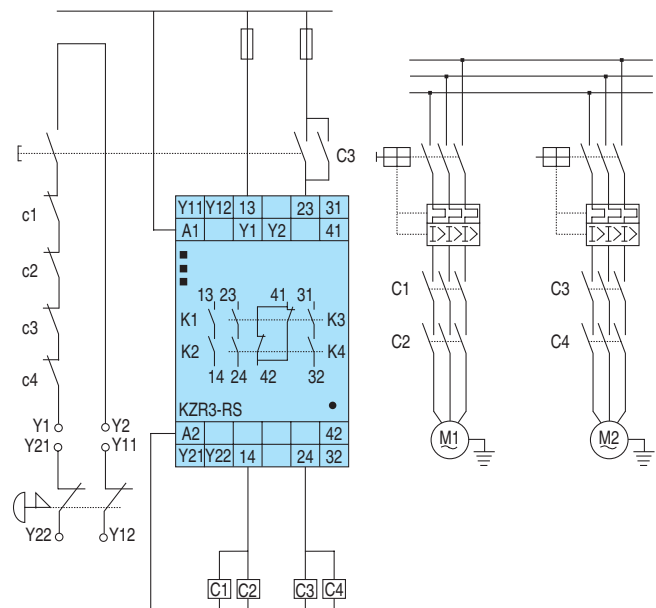

# Safety relay

## → Extension relay

- Extending the number of contacts in a safety relay
- Used to increase the breaking capacity of the main unit
- "CE" conforming product / BG approved
- Safety via redundancy and self-checking
- 3 "N/O" safety contacts with linked contacts  
6 A / 250 V AC
- 1 "N/C" return loop



### Specifications

Type	Supply voltage	Connections	Weight (g)	Code
KZE3-XS	24 V AC DC	Screw terminals	310	85 100 936
	40 / 260 V AC	Screw terminals	310	85 100 937
KZEC3-XS	24 V	Spring terminals	310	85 101 936
	40 - 260 V	Spring terminals	310	85 101 937

### General characteristics

Supply	
Operating range	- 15 % / + 10 % of $U_n$ for AC - 15 % / + 15 % of $U_n$ for DC
Precision	
Synchronisation difference	< 25 ms
Maximum response time on emergency stop at $U_n$	50 ms
Output specification	
Number of data circuits	3 "NO" AgSnO <sub>2</sub> contact
Return loop	1 "NC" AgSnO <sub>2</sub> contact
Function and use	
Max. absorbed power	AC 1.6 VA / DC 2 W
Dielectric strength	2.95 kV according to CEI 664-1
Resistance to tracking	Material group III
EMC immunity according to EN 50082-2	
Radiated electromagnetic field	10 V/m Level 3 acc. to IEC 1000.4.2 80 MHz to 1GHz / 900 MHz (ENV 50140/204)
Electrostatic discharge	8 kV in the air acc. to IEC 1000.4.2
Shock waves	Common mode 1 kV acc. to IEC 1000.4.5
Radio frequencies in common mode	10 Vrms Level 3 acc. to IEC 1000.4.6 150 kHz to 80 MHz (ENV 50141) acc. to IEC 1000.4.11

### Dimensions

#### KZE3-XS

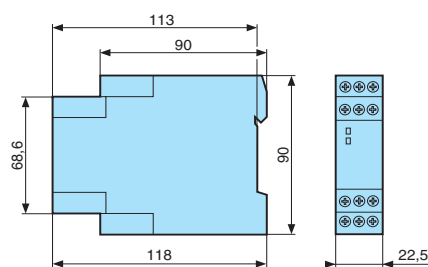

#### Mounting - Removing

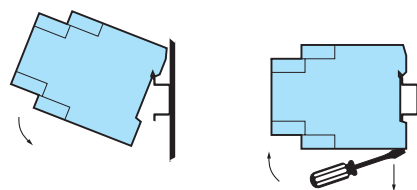

### Principles

#### Control devices :

Depending on the degree of safety required, the KZE3-XS can be controlled by one or two channels. In most cases, control by one channel will be sufficient. Please consult your inspection office for further information.

#### Control devices :

The KZE3-XS has three "N/O" safety contacts (13-14/23-24/33-34) and a return loop (X1-X2) which must be included in the "start / validation" line (Y1-Y2) of the main unit. One or more control devices may be wired up to the breaking capacity of the safety contacts : 1500 VA. However, to limit internal heating in the KZE3-XS, it is advisable not to exceed 10 A thermal for all three contacts.

#### Extending the number of contacts :

It is possible to wire several extension KZE3-XS units in cascade. All the return loops (X1-X2) will be in series with the "start/validation" line (Y1-Y2) of the main unit.

To order, see page 6

## Connections

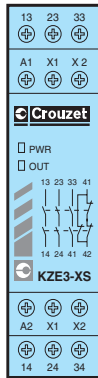

A1-A2 Power supply-Control device (s)  
 41-42 Return contact  
 13-14/23-24/33-34 "N/O" safety contacts  
 X1-X2 Internal return loop

## Applications

**Example of wiring  
 KZE3-XS controlled by a single  
 channel as an extension of a KNA3-XS**

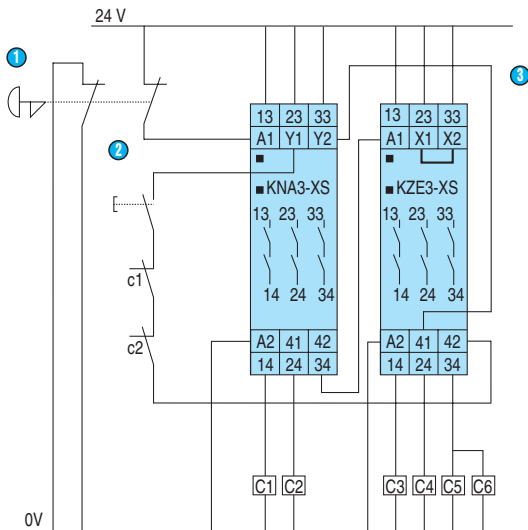

- ① Emergency stop
- ② Start
- ③ X1-X2 of the KZE3-XS bridged

**KNA3-RS with KZE3-XS extension unit**

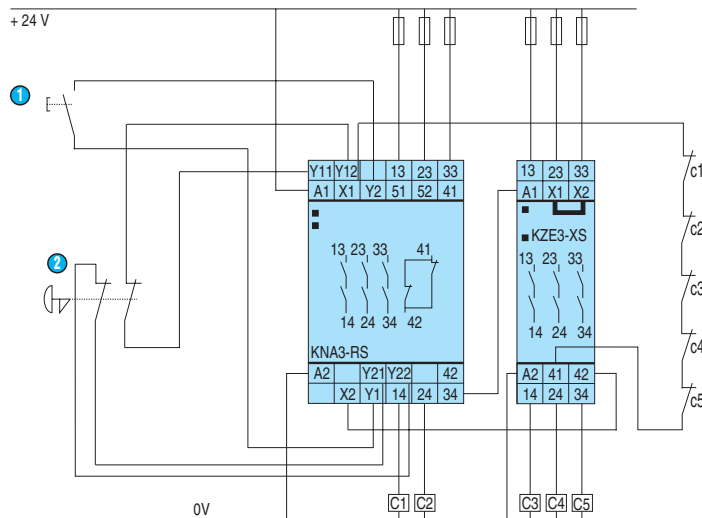

- ① Start
- ② Emergency stop

**Two KZE3-XS as extensions of a KNA3-XS**

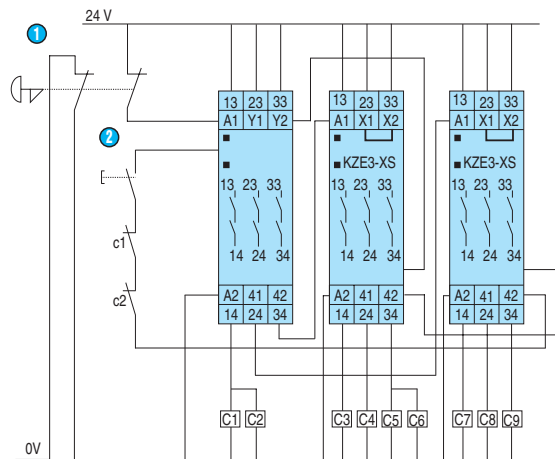

- ① Emergency stop
- ② Start

# Safety relay

## → Zero speed monitoring

- "Zero speed monitoring" function for a single or 3-phase motor
- Detection of actual stopping by measuring remanent voltages
- 1 "N/O" safety contact with linked contacts-6 A / 250 V AC
- 1 "N/C" safety contact with linked contacts-6 A / 250 V AC
- Separate return loop
- Level 4 according to NF.EN 954-1



### Specifications

Type	Supply voltage	Connections	Weight (g)	Code
KSW2-RS	24 V AC DC	Screw terminals	410	85 100 326

### General characteristics

#### Supply

Operating range	- 15 % / + 10 % of Un for AC - 15 % / + 15 % of Un for DC
-----------------	--

#### Precision

Reset time (self-test)	3 s
Setting for channels 1 and 2	20 mV → 500 mV +/-15 %
Synchronisation difference	< 3 s
Hysteresis	40 % +/- 50 %

#### Output specification

Number of safety circuits	1 "N/O" + 1 "NC" contact AgSnO2
---------------------------	------------------------------------

#### Function and use

Max. absorbed power	AC 1.6 VA / DC 2 W
Dielectric strength	2.95 kV according to IEC 664-1
Resistance to tracking	Material group III

#### EMC immunity according to EN 50082-2

Radiated electromagnetic field	30 V/m Level X acc. to IEC 1000.4.3 80 MHz to 1GHz / 900 MHz (ENV 50140 / 204)
Electrostatic discharge	15 kV in the air acc. IEC 1000.4.2
Shock waves	Level 3 according to IEC 1000.4.5 Common mode 2 kV for 24 V DC and 24 V AC
Radio frequencies in common mode	30 V rms Level X acc.to IEC 1000.4.6 150 kHz to 80 MHz (ENV 50141) acc. to IEC 1000.4.11

### Dimensions

#### KSW2-RS

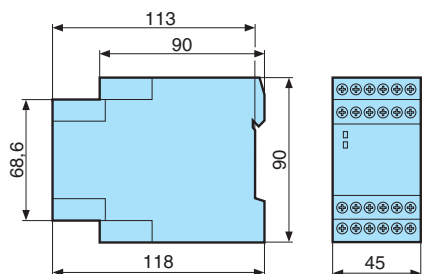

#### Mounting - Removing

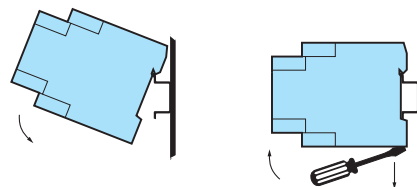



## Connections

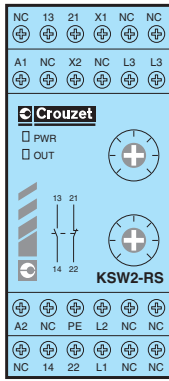

A1-A2 Power supply  
 X1-X2 Return loop  
 L1-L2 Input channel 1 (motor winding)  
 L2-L3 Input channel 2 (motor winding)  
 13-14 "N/O" safety contacts  
 21-22 "N/C" safety contacts

## Principles

### Self-test :

When terminals A1-A2 are powered up, a test sequence is initiated : the output relays (terminals 13-14 and 21-22) are energised for 1.5 s then separate for 1.5 s. If no fault is detected, the relays reattach.

This test checks :

- failure of the output contacts (terminals 13-14 and 21-22)
- breaking of one of the phases (L1, L2 or L3)
- the validity of the return loop (X1-X2)
- the failure of an internal component

### Safety function :

When an electric motor rotates while no longer supplied with power, it behaves like a generator, supplying voltage (called remanent) to the terminals of its windings. This voltage varies according to several parameters : speed of rotation, the motor characteristics, remanent magnetisation, inertia of the mechanical assembly. The KSW2-RS measures this voltage and interprets it so that the doors and mobile guards can only be opened once the motor has actually stopped.

### Setting :

Both channels are set on the front of the KSW2-RS using two potentiometers. This mitigates the effects of any imbalance between the windings or remanent voltages. Setting is within a range of 20 mV to 500 mV in order to adapt a threshold to a slow or zero speed, which is not dangerous for the operator.

### Control devices :

The KSW2-RS has one "N/O" (13-14) and one "N/C" (21-22) safety contact. One or more control devices may be wired up to the breaking capacity of the safety contacts : 1500 VA

### Extending the number of contacts :

The number of contacts of the KSW2-RS can be extended and the breaking capacity thus increased. To do this, use the KZE3-XS

## Applications

### Example

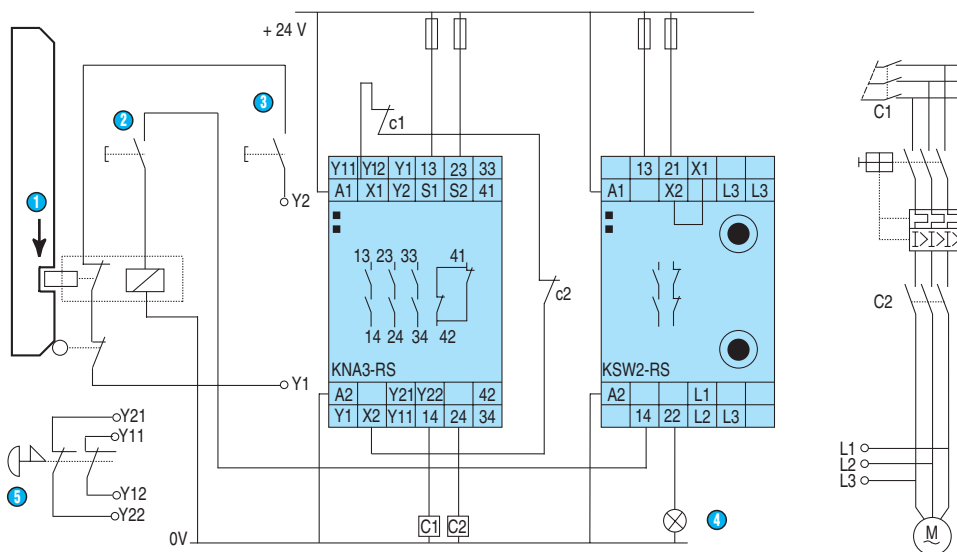

# Safety relay

## → 2-hand control

- Type III C "2-hand control" functions according to EN 574/97
- Control device with two channels
- Level 4 according to NF.EN 954-1
- "KZH2-XS" :
  - 2 "N/O" safety contacts with linked contacts-6A/250 VAC
- "KZH3-RS" :
  - 3 "N/O" safety contacts with linked contacts-6A/250 VAC
  - "NC" signalling contact



### Specifications

Type	Supply voltage	Connections	Weight (g)	Code
KZH2-XS	24 VAC DC	Screw terminal	230	85 100 626
KZH3-RS	24 V AC DC	Screw terminal	310	85 100 636
	115 V AC	Screw terminal	410	85 100 634
	230 V AC	Screw terminal	410	85 100 635

### General characteristics

Operating range	-15 % / +10 % of Un for AC -10 % / + 15 % of Un for DC
Synchronisation difference	KZH2-XS : < 500 ms
Reset time	KZH3-RS / < 500 ms
Response time on release of control device	KZH3-RS : < 20 ms
Maximum response time on emergency stop at Un	KZH3-RS : < 20 ms
Number of safety circuits	KZH2-XS : 2 "N/O" AgSnO2 contacts KZH3-RS : 3 "N/O" AgSnO2 contacts
Number of data circuits	KZH3-RS : 1 "NC" AgSnO2 contacts
Max. absorbed power	KZH2-XS : AC 1.5 VA / DC 1.5 W KZH3-RS : 24 AC 1.5 VA / 24 DC 1.5 W / 115-230 AC 3.2 VA
Dielectric strength	2.95 kV according to IEC 664-1
Resistance to tracking	Material group III
Radiated electromagnetic field	30 V / m Level X acc. to IEC 1000.4.3 80 MHz to 1GHz / 900 MHz (ENV50140 / 204)
Electrostatic discharge	15 kV in the air acc. to IEC 1000.4.2
Shock waves	Level 3 acc. to IEC 1000.4.5 Common mode 2 kV for 24 V DC and 24 V AC KZH3-RS / Common mode 4 kV for 230 V AC 2kV residual current mode
Radio frequencies in common mode	10 V rms on inputs / level 3 acc. to IEC 1000.4.6 30 V rms on supp. / Level X acc. to IEC 1000.4.6 150 kHz to 80 MHz (ENV 50141) acc. to IEC 1000.4.11

### Dimensions

KZH2-XS

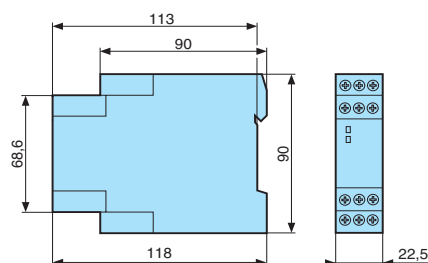

KZH3-RS

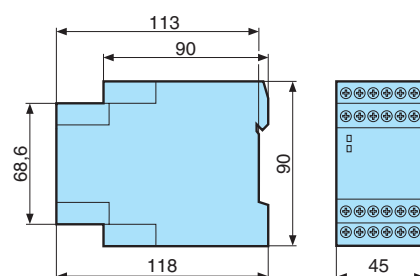

Mounting - Removing

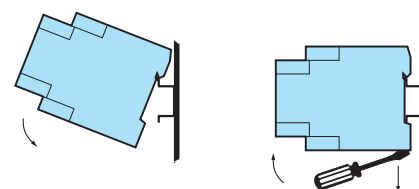

To order, see page 6

## Connections

### KZH2-XS

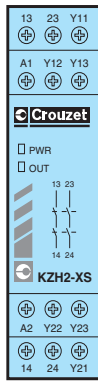

A1-A2 Power supply  
Y11-Y12-Y13 / Y21-Y22-Y23 Redundant inputs with differentiated voltage for control devices  
13-14/23-24 "N/O" safety contacts

### KZH3-RS

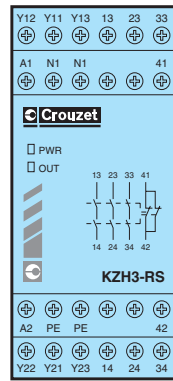

A1-A2 Power supply  
Y11-Y12-Y13 / Y21-Y22-Y23 Redundant inputs with differentiated voltage for control devices  
13-14/23-24/33-34 "N/O" safety contacts  
41-42 "N/C" signalling contacts

## Principles

### Control devices :

The KZH2-XS and KZH3-RS can receive the following components as inputs :  
- two pushbuttons with two positions "N/O" + "N/C" (Y11-Y12-Y13 and Y21-Y22-Y23)  
- one or two emergency stop pushbuttons with one or two channels (A1-A2).

### Control devices :

The KZH2-XS has two "N/O" safety contacts (13-14/23-24). One or more control devices may be wired up to the breaking capacity of the safety contacts : 1500 VA. However, to limit internal heating in the KZH2-XS, it is advisable not to exceed 8 A thermal for both contacts.

The KZH3-RS has three "N/O" safety contacts (13-14/23-24/33-34) and one "N/C" signalling contact (41/42). One or more control devices may be wired up to the breaking capacity of the safety contacts : 1500 VA. However, to limit internal heating in the KZH3-RS, it is advisable not to exceed 10 A thermal for both contacts.

### Extending the number of contacts :

The number of contacts can be extended and the breaking capacity thus increased. To do this, use the KZE3-XS.

## Applications

### KZH2-XS

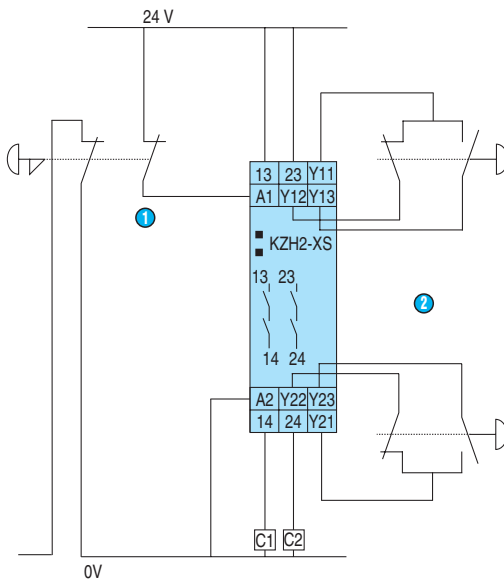

- ① Emergency stop
- ② 2-hand control console

### KZH3-RS

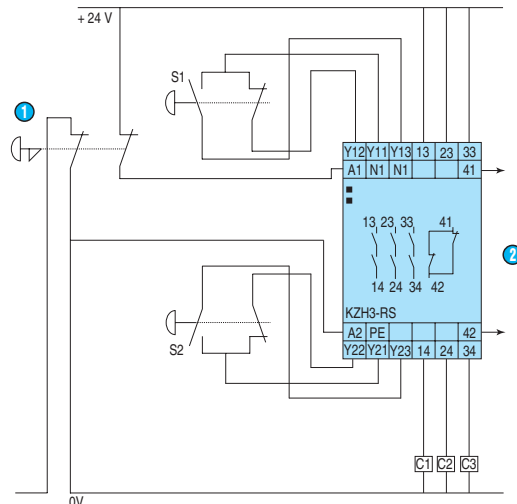

- ① Emergency stop
- ② Signalling

KZH3-RS with KZE3-X3 extension module

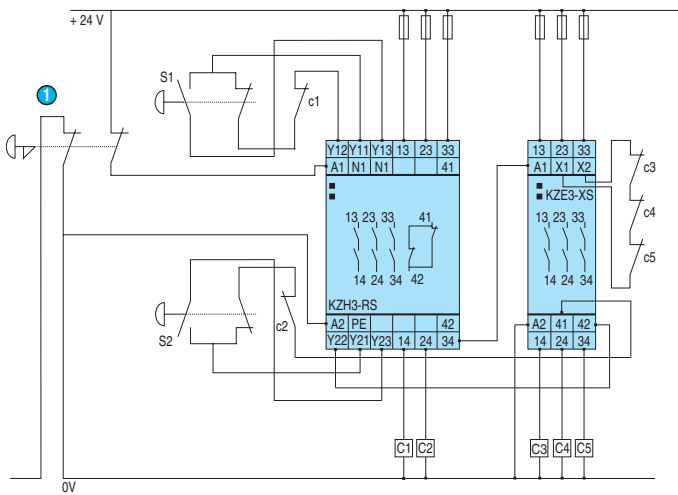

1 Emergency stop

## Safety relay: general characteristics

- Emergency stop
- Timed contacts
- Extension relay
- Zero speed monitoring
- 2-hand control

Supply	
Supply voltage	24 V AC 50 / 60 Hz 24 V DC maximum ripple 10 %
On/off indication	1 power supply voltage LED
Output specification	
Type	Volt-free outputs
Breaking capacity (V resistive)	1500 VA
Max. breaking current	6.82 A
Max. breaking voltage	440 V AC
Electrical endurance	10 <sup>6</sup> operations at 1500 VA resistive 5.10 <sup>6</sup> operations at 500 VA resistive
Mechanical life (operations)	10 <sup>7</sup>
Function and use	
On/off indication	1 internal relay status LED
Operating temperature (°C) IEC 68-2-14	0 → +50
Storage temperature (IEC 68-2-12) (°C)	-20 → +70
Internal voltage	24 V DC
EMC immunity according to EN 50082-2	
fast transients	2kV directly acc. to IEC 1000.4.4 4 kV directly for the 230 V <ac> version 2 Kv when coupled
Drop-out / short breaks / microbreaks	Un-30 % for 10 ms every 1 s Un-60 % for 100 ms every 1 s according to IEC 61496-1/97 Un-100 % for 10 ms every 100 ms Un-50 % for 20 ms every 200 ms Un-50 % for 500 ms every 5 s
Material	Polycarbonate Self-extinguishing-UL94 class VO
Protection Housing	IP 40
Protection Terminal	IP 20
Tightening capacity	2 x 1.5 mm <sup>2</sup> multicore with ferrule 2 x 2.5 mm <sup>2</sup> solid conductor
Spring terminals, 2 terminals per connection point - rigid wire	2.5 mm <sup>2</sup>
Spring terminals, 2 terminals per connection point - flexible wire	1.5 mm <sup>2</sup>

# Two-hand control console

## → Two-hand control

- Used in conjunction with a "KZH3" safety start module for two-hand control applications : folding, clipping, punching, rail-cutting, bending, drilling, presses, etc.
- Supplied with an emergency stop button and 2 spring-return mushroom head pushbuttons.
- Conforms to EN 574 concerning safety applications



### Specifications

Type	Designation	Code
KSP	KSP2 two-hand control console	85 100 293
	KSP console fixing foot	85 100 292

### Accessories

	Code
Mushroom head emergency stop	79 697 001
Spring-return pushbuttons	79 697 101

### Dimensions

85 100 291

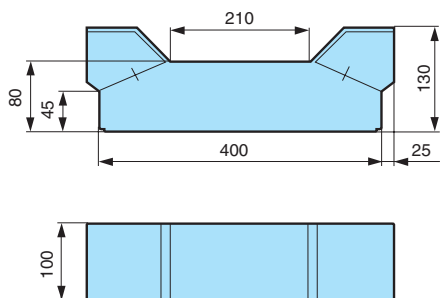

85 100 292

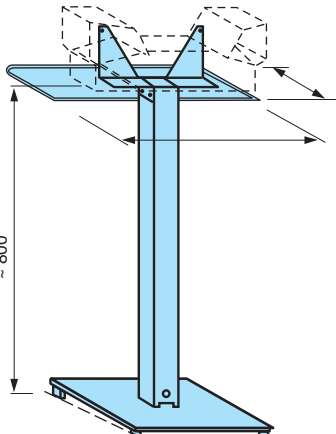

79 697 101

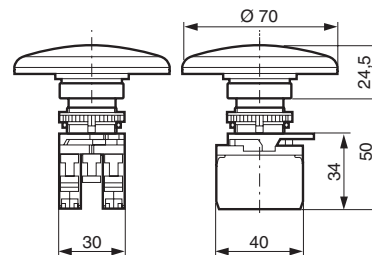

# Micro-PLCs







## RPX micro-PLCs

- Compact ... high-performance ... user-friendly, with 10 to 48 modular I/O
- Extension modules : digital and analogue I/O, 13 kHz high-speed counter and communications
- Communication using ASI, CBUS (MODBUS® compatible), PROFIBUS, and PROFIBUS/MODBUS, MODBUS/ASI and PROFIBUS/ASI gateways
- ASIO 20 and 67 inputs/outputs using ASI for distributed control system applications
- Programmed via RPX C1 and C2 consoles or using RPX C3 software under Windows®

### Applications for control systems with centralised or distributed architecture

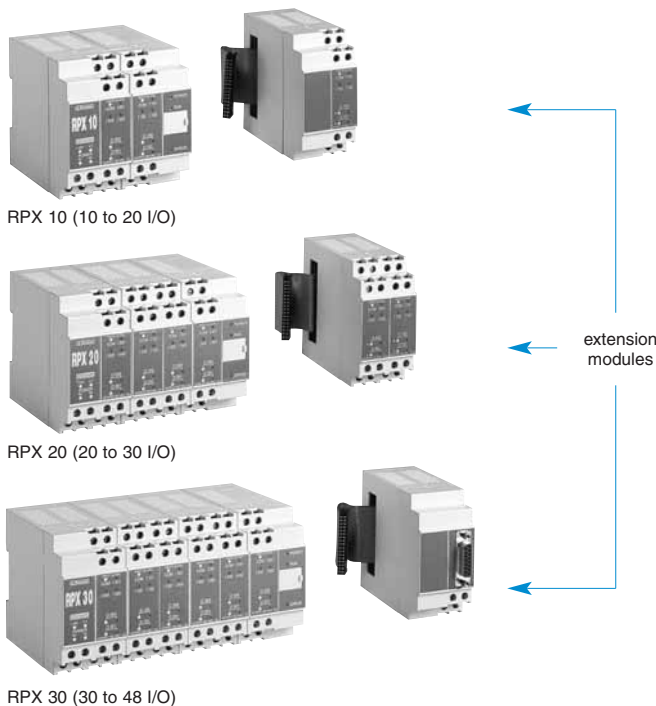

#### RPX, the standard open-access range, compatible with I/O extension modules :

- Digital I/O.
- Analogue I/O.
- Versions for communication using CBUS (Modbus® compatible), Profibus and ASI (Device Net and Interbus S being developed).
- Remote I/O using ASI and CBUS protocols.

The modular internal design of the RPX using plug-in boards offers the opportunity for multiple special configurations.

#### ■ Approvals

- CE marking (conforming to the low voltage directive 73/23/EEC)
- UL and C/UL approval.
- Level 3 electromagnetic compatibility in accordance with EN 60204-1 and IEC 801-2/3/4.
- Adapted for use in an industrial environment (conforming to IEC 1131-2).

#### ■ Easy to use

- DIN rail mounted.
- Screw terminals able to take 2 x 2.5 mm<sup>2</sup> wires.
- Compact dimensions, 90 x 104 x 45 or 225 mm depending on the version.

#### ■ 10 to 48 Inputs/Outputs

- Isolated 24 VDC inputs. For 2 or 3-wire NPN/PNP detectors and volt-free contacts.
- 1 x 3.5 kHz high-speed counter input.
- Independent, 2 A - 230 VDC relay outputs or 0.5 A - 24 VDC NPN/PNP transistor outputs.
- Analogue I/O 0-10 V or 0-20 mA.
- Pt 100 inputs - 50°C +80°C.
- Auxiliary power supply modules 24 VDC output, 120 or 230 VAC input.

#### ■ Flexible

- Extension modules for digital and analogue I/O, communications, etc., for low cost system upgrades.

### Applications for control systems with centralised architecture

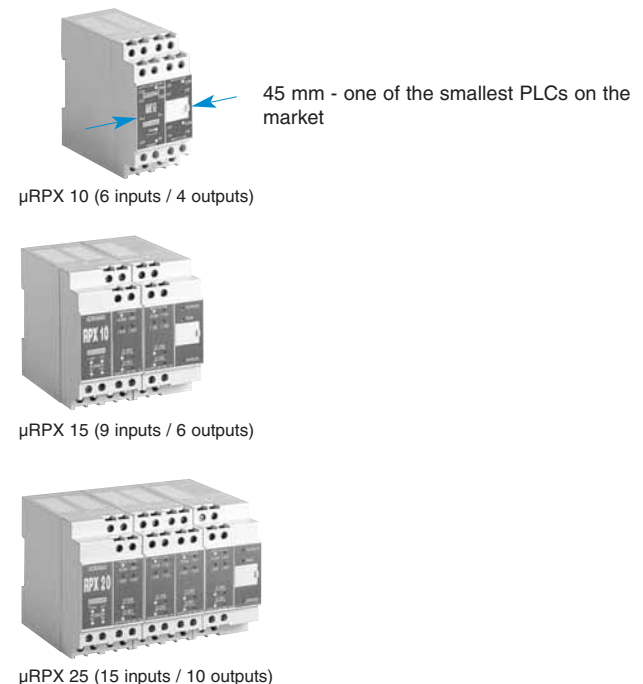

#### µRPX, the low-cost range for constructing simple control systems with digital I/O.

Compact size, ease of programming and installation make the µRPX 10, 15 and 25 three products which can do just about anything!

#### ■ Powerful

- A 16-bit micro-controller.
- Non-volatile EEPROM program memory holding 1100 or 2700 program steps depending on the model. More than 50 instructions available (including arithmetic).
- Data memory 512 x 16 bit words (256 words for µRPX 10, 15 and 25).
- 64 pre-programmed timer functions.
- 32 counters.

#### ■ Real-time clock

- Clock
- Calendar
- Time counter

#### ■ Programming languages

- Relay ladder diagrams.
- Function charts.
- Natural language.

#### ■ Diagnostics

- Indicators for I/O states and correct PLC operation.

**INDUSTRIAL**  
in their functions and presentation

- User-definable functions**
  - filtering and counting up to 500 Hz on digital inputs
  - time delay on digital outputs (steady, pulsed, flashing etc.) from 100 ms to 100 min.
  - threshold check or scaling of analogue inputs
  - freezing or fallback of digital and analogue outputs in the case of a fault
- Removable reference labels for inputs/outputs**
- Galvanic isolation**
- Sub-base of 1 to 4 terminal blocks with internal pre-wired commons**
- Mechanical location coding for mounting I/O modules on terminal block sub-bases.**

Up to 8 sensors or actuators per module

Removable modules

**OPEN**  
to fieldbuses  
Connection to Cbus\*, Profibus FMS and DP, Can Open

\*Modbus compatible®

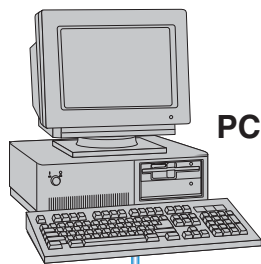

PC or PLC



MIDU parameters entered via switches

Exchange unit for connecting to fieldbuses

Up to 8 digital or analogue I/O modules

# FLEXIBLE

for all control  
system  
architectures

## Distributed control system with remote inputs/outputs

PLC or PC card

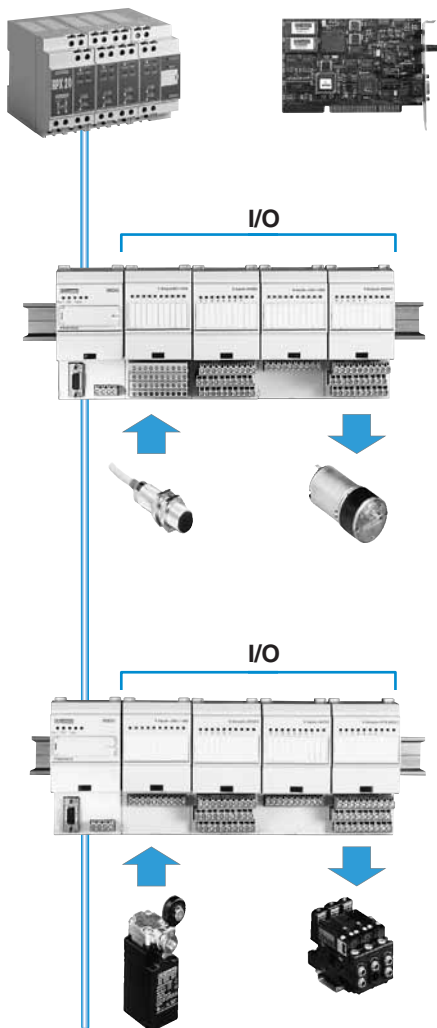

## Distributed control system with remote inputs/outputs and local processing by CPU module

PLC or PC card

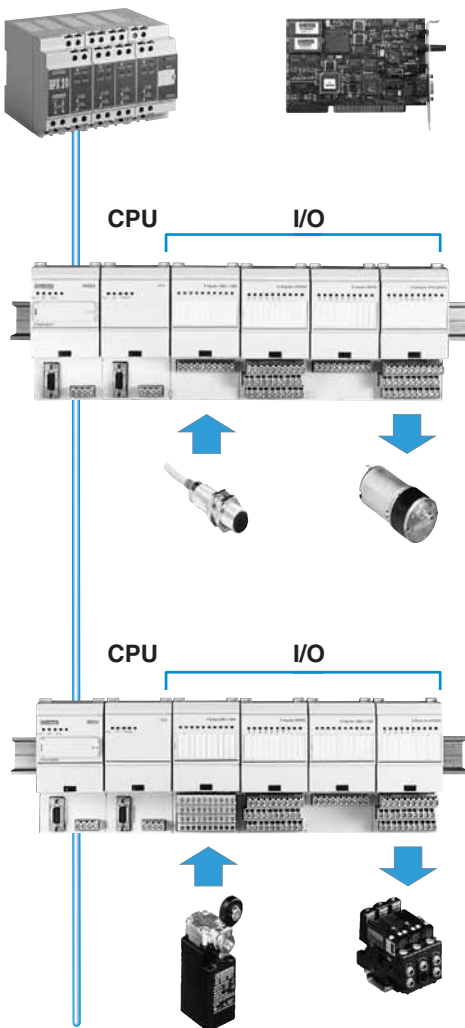

## Centralised control system

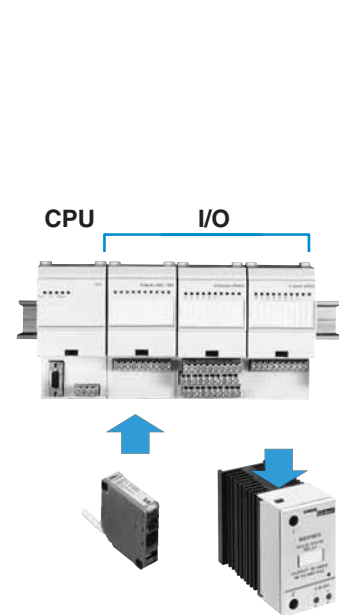

### Applications

- For assembly machines, special production machines, conveyors, rotating machines, etc.
- CBM, BMS : lighting, security, air conditioning, car parks, etc.
- On-board control systems : lorries, rail transport etc.

### Applications

- Adapted to the specific needs of delocalised control-command functions and to processing reflex functions (personnel and machine safety).
- For modular machines or machines with flexible configuration : design, acceptance tests, simplified operation and maintenance.

### Applications

- Compact control system applications with a small number of wire-to-wire I/O : lifts, coffee machines, vending machines, animated advertising panels, etc.

# Index by part number

Part numbers	Description	Page
<b>18 000 000</b>		
18 372 112	Temperature sensors - Heat transfer compound	24
18 373 112	Heat transfer compound	188
18 373 112	Heat transfer compound	194

<b>25 000 000</b>		
25 622 076	Digital TOP 948 - 11-pin solder-connected plug	78
25 622 077	Chronos 2 - 11-pin connector base (for the whole range)	42
25 622 080	Analogue TMR 48 - 11-pin connector base	74
25 622 128	Chronos 2 - 8-pin connector base	42
25 622 130	Analogue TMR 48 - 8-pin connector base	74
25 622 301	Digital 816 - 8-pin solder-connected plug	82

<b>26 000 000</b>		
26 532 702	Miniature - Spring clips for terminal base	46
26 532 704	Miniature - Spring clips for P.C.B. base	46
26 532 706	Miniature - Base for DIN rail mounting RTMA4	46
26 532 707	Miniature - Base for DIN rail mounting RTMA2	46
26 532 708	Miniature - Base for printed circuit board RTMA4	46
26 532 709	Miniature - Base for printed circuit board RTMA2	46
26 532 720	Heat seal	194
26 532 721	Heat seal	194
26 532 730	Fuses for GMS relays	194
26 532 731	Fuses for GMS relays	194
26 532 741	Varistor protection for solid state relays	194
26 532 742	Varistor protection for solid state relays	194
26 532 758	Heatsinks	195
26 532 759	Heatsinks	195
26 532 761	Heatsinks	195
26 532 762	Three-phase alternative current - Heat-sink	190
26 532 762	Heatsinks	195
26 532 764	Three-phase changeover, AC - DIN rail heatsinks	188
26 532 764	DIN rail adaptor	196
26 532 790	Heatsinks	195
26 532 796	Three-phase alternative current - Protective cover	190
26 532 796	Protective cover	196
26 532 797	Three-phase changeover, AC - Protective cover	188
26 532 797	Protective cover	196
26 532 798	Protective cover	196
26 532 801	Adaptors for fixing on panel (set of 4)	195
26 546 803	Electro-mechanical hour counter CH 48 G - DIN socket rail connector	266
26 546 805	Electro-mechanical hour counter CH 48 G - Bezel (grey) 55 x 55 mm	266
26 546 829	Totalizers - LCD 24 x 48 (Hour counter/chronometer) - Adaptor for cut-out Ø 50 (dimensions Ø 73 mm)	240
26 546 830	Totalizers - LCD 24 x 48 (Hour counter/chronometer) - Adaptor for cut-out 45 x 45 mm (dimensions 52 x 52 mm)	240
26 546 831	Totalizers - LCD 24 x 48 (Hour counter/chronometer) - Adaptor for cut-out 25x50 mm (dimensions 29x54 mm)	240

Part numbers	Description	Page
26 852 301	Digital temperature controllers MIC 48 - Current transformers 10 A / 50 mA	212
26 852 302	Digital temperature controllers MIC 48 - Current transformers 25 A / 50 mA	212
26 852 303	Digital temperature controllers MIC 48 - Current transformers 50 A / 50 mA	212
26 852 304	Current control - Current transformers for EIT 100 A / 50 mA	136

<b>79 000 000</b>		
79 222 640	Striker cams	274
79 222 640	Striker cams	276
79 222 640	Striker cams	278
79 222 640	Striker cams	280
79 222 641	Packet of extra strikers	274
79 222 641	Packet of extra strikers	276
79 222 641	Packet of extra strikers	278
79 222 641	Packet of extra strikers	280
79 237 709	Analogue temperature controllers - Protective cover IP 54	210
79 237 790	Digital TOP 948 - Spring clips	78
79 694 002	Digital TOP 948 - 11-pole rear base	78
79 694 005	Digital TOP 948 - Asymmetrical adaptor	78
79 694 016	Digital - 8-pin solder-connector base	86
79 696 006	Level control - S5	119
79 696 014	Level control - S3	119
79 696 030	Temperature probes - Thermocouple / PT100	220
79 696 031	Temperature probes - Thermocouple / PT100	220
79 696 032	Temperature probes - Thermocouple / PT100	220
79 696 033	Temperature probes - Thermocouple / PT100	220
79 696 034	Temperature probes - Thermocouple / PT100	220
79 696 035	Temperature probes - Thermocouple / PT100	220
79 696 036	Temperature probes - Thermocouple / PT100	220
79 696 037	Temperature probes - Thermocouple / PT100	220
79 696 038	Temperature probes - Connection	220
79 696 039	Temperature probes - Connection	220
79 696 040	Temperature probes - Connection	220
79 696 041	Temperature probes - Sub-base	220
79 696 042	Temperature probes - Flange	220
79 696 043	Level control - S7	119
79 696 044	Level control - S8	119
79 697 001	Two-hand control console - Mushroom head emergency stop	310
79 697 101	Two-hand control console - Spring-return pushbuttons	310

<b>84 000 000</b>		
84 028 251	Three-phase alternative current - Range GA3	190
84 028 451	Three-phase alternative current - Range GA3	190
84 028 453	Three-phase alternative current - Range GA3	190
84 028 459	Relay-heatsink assembly - Assembly	180
84 028 651	Three-phase alternative current - Range GA3	190
84 028 653	Three-phase alternative current - Range GA3	190
84 060 001	SMART SSR - " hockey puck "	184

## Index by part number

Part numbers	Description	Page	Part numbers	Description	Page
84 064 131	PCB-mountable - GA1 range	182	84 130 118	Single-phase, two-phase or three-phase, AC with integrated heatsink, for DIN rail and baseplate mounting - 45 mm	162
84 065 030	PCB-mountable - GA8 range	182	84 130 150	Single-phase, two-phase or three-phase, AC with integrated heatsink, for DIN rail and baseplate mounting - 22.5 mm	162
84 065 040	PCB-mountable - GA8 range	182	84 130 152	Single-phase, two-phase or three-phase, AC with integrated heatsink, for DIN rail and baseplate mounting - 22.5 mm	162
84 065 131	PCB-mountable - GA8 range	182	84 130 158	Single-phase, two-phase or three-phase, AC with integrated heatsink, for DIN rail and baseplate mounting - 45 mm	162
84 067 441	Three-phase changeover, AC - Alternative current	188	84 130 220	Single-phase, two-phase or three-phase, AC with integrated heatsink, for DIN rail and baseplate mounting - SCR zero voltage switching	168
84 067 449	Relay-heatsink assembly - Assembly	180	84 130 221	Single-phase, two-phase or three-phase, AC with integrated heatsink, for DIN rail and baseplate mounting - SCR Instantaneous switching	168
84 068 251	Three-phase alternative current - Range GA3	190	84 130 222	Single-phase, two-phase or three-phase, AC with integrated heatsink, for DIN rail and baseplate mounting - SCR zero voltage switching	168
84 068 409	Relay-heatsink assembly - Assembly	180	84 130 310	Single-phase, two-phase or three-phase, AC with integrated heatsink, for DIN rail and baseplate mounting - SCR zero voltage switching	166
84 068 451	Three-phase alternative current - Range GA3	190	84 130 311	Single-phase, two-phase or three-phase, AC with integrated heatsink, for DIN rail and baseplate mounting - SCR zero voltage switching	166
84 068 453	Three-phase alternative current - Range GA3	190	84 130 312	Single-phase, two-phase or three-phase, AC with integrated heatsink, for DIN rail and baseplate mounting - SCR Instantaneous switching	166
84 068 459	Relay-heatsink assembly - Assembly	180	84 130 511	SMART SSR - Self checking	187
84 068 651	Three-phase alternative current - Range GA3	190	84 132 000	Solid state relays - GZ range	186
84 068 653	Three-phase alternative current - Range GA3	190	84 132 010	Solid state relays - GZ range	186
84 068 659	Relay-heatsink assembly - Assembly	180	84 132 100	Solid state relays - GZ range	186
84 130 100	Single-phase, two-phase or three-phase, AC with integrated heatsink, for DIN rail and baseplate mounting - 22.5 mm	162	84 132 110	Solid state relays - GZ range	186
84 130 101	Single-phase, two-phase or three-phase, AC with integrated heatsink, for DIN rail and baseplate mounting - 22.5 mm	162	84 132 200	Solid state relays - GZ range	186
84 130 102	Single-phase, two-phase or three-phase, AC with integrated heatsink, for DIN rail and baseplate mounting - 22.5 mm	162	84 132 210	Solid state relays - GZ range	186
84 130 103	Single-phase, two-phase or three-phase, AC with integrated heatsink, for DIN rail and baseplate mounting - 22.5 mm	162	84 132 300	Solid state relays - GZ range	186
84 130 104	Single-phase, AC and DC 17.5 mm for DIN rail mounting - Transistor	179	84 132 310	Solid state relays - GZ range	186
84 130 105	Single-phase, AC and DC 17.5 mm for DIN rail mounting - 17.5 mm	179	84 132 400	Solid state relays - GZ range	186
84 130 108	Single-phase, AC and DC 17.5 mm for DIN rail mounting - 17.5 mm	179	84 132 410	Solid state relays - GZ range	186
84 130 110	Single-phase, two-phase or three-phase, AC with integrated heatsink, for DIN rail and baseplate mounting - Zero voltage switching SCR output	164	84 132 500	Solid state relays - GZ range	186
84 130 111	Single-phase, two-phase or three-phase, AC with integrated heatsink, for DIN rail and baseplate mounting - Zero voltage switching SCR output	164	84 132 510	Solid state relays - GZ range	186
84 130 112	Single-phase, two-phase or three-phase, AC with integrated heatsink, for DIN rail and baseplate mounting - Instantaneous switching Thyristor output	164	84 132 600	Solid state relays - GZ range	186
84 130 113	Single-phase, two-phase or three-phase, AC with integrated heatsink, for DIN rail and baseplate mounting - Zero voltage switching SCR output	164	84 132 610	Solid state relays - GZ range	186
84 130 114	Single-phase, two-phase or three-phase, AC with integrated heatsink, for DIN rail and baseplate mounting - Instantaneous switching Thyristor output	164	84 132 700	Solid state relays - GZ range	186
84 130 115	Single-phase, two-phase or three-phase, AC with integrated heatsink, for DIN rail and baseplate mounting - Zero voltage switching SCR output	164	84 132 710	Solid state relays - GZ range	186
84 130 116	Single-phase, two-phase or three-phase, AC with integrated heatsink, for DIN rail and baseplate mounting - 45 mm	162	84 134 000	Single-phase GN - Single-phase	176
84 130 117	Single-phase, two-phase or three-phase, AC with integrated heatsink, for DIN rail and baseplate mounting - 90 mm Three-phase	162	84 134 001	Single-phase GN - Single-phase	176
			84 134 002	Single-phase GN - Single-phase	176
			84 134 010	Single-phase GN - Single-phase	176
			84 134 011	Single-phase GN - Single-phase	176
			84 134 012	Single-phase GN - Single-phase	176
			84 134 020	Single-phase GN - Single-phase	176
			84 134 021	Single-phase GN - Single-phase	176
			84 134 022	Single-phase GN - Single-phase	176
			84 134 030	Single-phase GN - Single-phase	176
			84 134 031	Single-phase GN - Single-phase	176
			84 134 032	Single-phase GN - Single-phase	176
			84 134 040	Single-phase GN - Single-phase	176
			84 134 041	Single-phase GN - Single-phase	176
			84 134 042	Single-phase GN - Single-phase	176
			84 134 080	Single-phase GN - Single-phase	176
			84 134 081	Single-phase GN - Single-phase	176



## Index by part number

Part numbers	Description	Page	Part numbers	Description	Page
84 137 382	Single-phase GN - Single-phase	176	84 871 031	Current control - EIH	136
84 137 750	Single-phase GN - Bipolar version	170	84 871 032	Current control - EIH	136
84 137 850	Single-phase GN - FET VERSION	170	84 871 033	Current control - EIH	136
84 137 860	Single-phase GN - FET VERSION	170	84 871 034	Current control - EIH	136
84 137 870	Single-phase GN - FET VERSION	170	84 871 040	Current control - EIT	136
84 138 000	Hybrid power relays - Contactor	160	84 871 041	Current control - EIT	136
84 138 001	Hybrid power relays - Contactor	160	84 871 042	Current control - EIT	136
84 138 002	Hybrid power relays - Contactor	160	84 871 043	Current control - EIT	136
84 138 101	Hybrid power relays - Impulse relay	160	84 871 044	Current control - EIT	136
84 138 201	Hybrid power relays - Day/night contactor	160	84 871 102	Current control - MCI	134
84 140 000	Two-phase solid state relay - Dual range	174	84 871 301	Control with LCD display - Voltage - Current - HDI - L	130
84 140 010	Two-phase solid state relay - Dual range	174	84 871 302	Control with LCD display - Voltage - Current - HDI - L	130
84 140 100	Two-phase solid state relay - Dual range	174	84 871 304	Control with LCD display - Voltage - Current - HDI - L	130
84 140 110	Two-phase solid state relay - Dual range	174	84 871 305	Control with LCD display - Voltage - Current - HDI - L	130
84 140 200	Two-phase solid state relay - Dual range	174	84 871 306	Control with LCD display - Voltage - Current - HDI - H	130
84 140 210	Two-phase solid state relay - Dual range	174	84 871 307	Control with LCD display - Voltage - Current - HDI - H	130
84 140 300	Two-phase solid state relay - Dual range	174	84 871 309	Control with LCD display - Voltage - Current - HDI - H	130
84 140 310	Two-phase solid state relay - Dual range	174	84 871 310	Control with LCD display - Voltage - Current - HDI - H	130
84 861 501	Panel-mounted - Inverter for DC supply CC24 148 V DC	92	84 872 020	Voltage control - EUL	138
84 861 501	DIN rail mounted - Inverter for DC supply	56	84 872 021	Voltage control - EUL	138
84 861 501	Inverter for DC supply 24 • 48 V	274	84 872 023	Voltage control - EUL	138
84 861 501	Inverter for DC supply 24 • 48 V	276	84 872 024	Voltage control - EUL	138
84 861 501	Inverter for DC supply 24 • 48 V	278	84 872 030	Voltage control - EUH	138
84 861 501	Inverter for DC supply 24 • 48 V	280	84 872 031	Voltage control - EUH	138
84 861 501	Inverter for DC supply 24 • 48 V	282	84 872 033	Voltage control - EUH	138
84 861 502	Inverter for DC supply 24 • 48 V	274	84 872 034	Voltage control - EUH	138
84 861 502	Inverter for DC supply 12 V	276	84 872 040	Voltage control - EUS	140
84 861 502	Inverter for DC supply 12 V	278	84 872 046	Voltage control - EUS	140
84 861 502	Inverter for DC supply 12 V	280	84 872 047	Voltage control - EUS	140
84 861 502	Inverter for DC supply 12 V	282	84 872 056	Voltage control - EUSF	140
84 861 503	DIN rail mounted - Inverter for DC supply	56	84 872 057	Voltage control - EUSF	140
84 861 503	Inverter for DC supply 110 • 127 V	276	84 872 301	Control with LCD display - Voltage - Current - HDU - L	130
84 861 503	Inverter for DC supply 110 • 127 V	274	84 872 302	Control with LCD display - Voltage - Current - HDU - L	130
84 861 503	Inverter for DC supply 110 • 127 V	278	84 872 304	Control with LCD display - Voltage - Current - HDU - L	130
84 861 503	Inverter for DC supply 110 • 127 V	280	84 872 305	Control with LCD display - Voltage - Current - HDU - L	130
84 861 503	Inverter for DC supply 110 • 127 V	282	84 872 306	Control with LCD display - Voltage - Current - HDU - H	130
84 870 201	Level control - ENR	104	84 872 307	Control with LCD display - Voltage - Current - HDU - H	130
84 870 202	Level control - ENR	104	84 872 309	Control with LCD display - Voltage - Current - HDU - H	130
84 870 203	Level control - ENR	104	84 872 310	Control with LCD display - Voltage - Current - HDU - H	130
84 870 204	Level control - ENR	104	84 873 004	Phase control - EWS2	120
84 870 211	Level control - ENRM	106	84 873 010	Phase control - FW	124
84 870 212	Level control - ENRM	106	84 873 011	Phase control - FW	124
84 870 213	Level control - ENRM	106	84 873 012	Phase control - FW	124
84 870 214	Level control - ENRM	106	84 873 013	Phase control - FW	124
84 870 301	Level control - LN	110	84 873 014	Phase control - FW	124
84 870 303	Level control - LN	110	84 873 015	Phase control - FW	124
84 870 304	Level control - LN	110	84 873 016	Phase control - FW	124
84 870 306	Level control - LN	110	84 873 200	Voltage control - F3US	142
84 870 308	Level control - LN	110	84 873 201	Voltage control - F3US	142
84 870 309	Level control - LN	110	84 873 210	Voltage control - F3US	142
84 870 401	Level control - L2N	112	84 873 211	Voltage control - F3US	142
84 870 403	Level control - L2N	112	84 873 300	Phase control - FWA	126
84 870 404	Level control - L2N	112	84 873 301	Phase control - FWA	126
84 870 501	Level control - FN	116	84 873 310	Phase control - FWA	126
84 870 502	Level control - FN	116			
84 870 503	Level control - FN	116			
84 870 504	Level control - FN	116			
84 870 601	Level control - F2N	114			
84 870 602	Level control - F2N	114			
84 870 603	Level control - F2N	114			
84 870 604	Level control - F2N	114			
84 870 803	Level control - FN LS	116			
84 870 807	Level control - LN	110			
84 870 808	Level control - L2N	112			
84 871 020	Current control - EIL	136			
84 871 021	Current control - EIL	136			
84 871 022	Current control - EIL	136			
84 871 023	Current control - EIL	136			
84 871 024	Current control - EIL	136			
84 871 030	Current control - EIH	136			

## Index by part number

Part numbers	Description	Page
84 873 311	Phase control - FWA	126
84 873 400	Motor control - FFP	144
84 873 401	Motor control - FFP	144
84 873 402	Motor control - FFP	144
84 873 403	Motor control - FFP	144
84 873 404	Motor control - FFP	144
84 873 501	Phase control - EWA2	122
84 873 502	Phase control - EWA2	122
84 873 511	Phase control - EW2	122
84 873 512	Phase control - EW2	122
84 874 013	Motor control - ETM	148
84 874 014	Motor control - ETM	148
84 874 015	Motor control - ETM	148
84 874 023	Motor control - ETM2	148
84 874 024	Motor control - ETM2	148
84 874 025	Motor control - ETM2	148
84 874 033	Motor control - ETM22	148
84 874 034	Motor control - ETM22	148
84 874 035	Motor control - ETM22	148
84 874 300	Motor control - FRL	146
84 874 301	Motor control - FRL	146
84 874 303	Motor control - FRL	146
84 874 304	Motor control - FRL	146
84 886 019	Variable speed - VRT 300	152
84 892 299	Phase control - EWS	120

### 85 000 000

85 100 036	Safety relay - KNA3-XS	296
85 100 037	Safety relay - KNA3-XS	296
85 100 292	Two-hand control console - KSP	310
85 100 293	Two-hand control console - KSP	310
85 100 326	Safety relay - KSW2-RS	304
85 100 434	Safety relay - KNA3-RS	296
85 100 435	Safety relay - KNA3-RS	296
85 100 436	Safety relay - KNA3-RS	296
85 100 526	Safety relay - KZHNV-XS	294
85 100 536	Safety relay - KZP3-RS	296
85 100 626	Safety relay - KZH2-XS	306
85 100 634	Safety relay - KZH3-RS	306
85 100 635	Safety relay - KZH3-RS	306
85 100 636	Safety relay - KZH3-RS	306
85 100 736	Safety relay - KZR3-RS	300
85 100 936	Safety relay - KZE3-XS	302
85 100 937	Safety relay - KZE3-XS	302
85 101 036	Safety relay - KNAC3-XS	296
85 101 037	Safety relay - KNAC3-XS	296
85 101 936	Safety relay - KZEC3-XS	302
85 101 937	Safety relay - KZEC3-XS	302

### 87 000 000

87 606 010	Totalizer/hour counter module - 108	258
87 606 020	Totalizer/hour counter module - 108	258
87 606 110	Totalizer/hour counter module - 108	258
87 606 120	Totalizer/hour counter module - 108	258
87 606 330	Totalizer/hour counter module - C108	256
87 610 040	Totalizers - LCD 24 x 48 - 2231	246
87 610 050	Totalizers - LCD 24 x 48 - 2232	246
87 610 140	Hour counters - LCD 24 x 48 - 2213	242
87 610 150	Hour counters - LCD 24 x 48 - 2214	242
87 610 240	Total/partial impulse counters - LCD 24 x 48 - 2293	250
87 610 250	Total/partial impulse counters - LCD 24 x 48 - 2294	250
87 610 340	Totalizers - LCD 24 x 48 (Hour counter/chronometer) - 2108	240
87 610 440	Totalizers - LCD 24 x 48 (Hour counter/chronometer) - 2108H	240

Part numbers	Description	Page
87 614 040	Totalizer - Ratemeter - Totalizer and Ratemeter - LCD 36 x 72 - 3233	254
87 614 340	Totalizer - Ratemeter - Totalizer and Ratemeter - LCD 36 x 72 - 3253	254
87 614 440	Totalizer - Ratemeter - Totalizer and Ratemeter - LCD 36 x 72 - 3293	254
87 618 012	Preselection and multifunction up/down counters 48x48 - 4141-1 preset	232
87 618 014	Preselection and multifunction up/down counters 48x48 - 4141-1 preset	232
87 618 018	Preselection and multifunction up/down counters 48x48 - 4141-1 preset	232
87 618 022	Preselection and multifunction up/down counters 48x48 - 4142-2 preset	232
87 618 024	Preselection and multifunction up/down counters 48x48 - 4142-2 preset	232
87 618 028	Preselection and multifunction up/down counters 48x48 - 4142-2 preset	232
87 618 032	Preselection and multifunction up/down counters 48x48 - 4144-2 preset	232
87 618 034	Preselection and multifunction up/down counters 48x48 - 4144-2 preset	232
87 618 038	Preselection and multifunction up/down counters 48x48 - 4144-2 preset	232
87 618 042	Preselection and multifunction up/down counters 48x48 - 4141-1 preset	232
87 618 044	Preselection and multifunction up/down counters 48x48 - 4141-1 preset	232
87 618 048	Preselection and multifunction up/down counters 48x48 - 4141-1 preset	232
87 618 062	Preselection and multifunction up/down counters 48x48 - 4142-2 preset	232
87 618 064	Preselection and multifunction up/down counters 48x48 - 4142-2 preset	232
87 618 068	Preselection and multifunction up/down counters 48x48 - 4142-2 preset	232
87 618 072	Preselection and multifunction up/down counters 48x48 - 4144-2 preset	232
87 618 074	Preselection and multifunction up/down counters 48x48 - 4144-2 preset	232
87 618 078	Preselection and multifunction up/down counters 48x48 - 4144-2 preset	232
87 618 112	Preselection and multifunction up/down counters 48x48 - 4341-1 preset	233
87 618 114	Preselection and multifunction up/down counters 48x48 - 4341-1 preset	233
87 618 118	Preselection and multifunction up/down counters 48x48 - 4341-1 preset	233
87 618 122	Preselection and multifunction up/down counters 48x48 - 4342-2 preset	233
87 618 124	Preselection and multifunction up/down counters 48x48 - 4342-2 preset	233
87 618 128	Preselection and multifunction up/down counters 48x48 - 4342-2 preset	233
87 618 132	Preselection and multifunction up/down counters 48x48 - 4344-2 preset	233
87 618 134	Preselection and multifunction up/down counters 48x48 - 4344-2 preset	233
87 618 138	Preselection and multifunction up/down counters 48x48 - 4344-2 preset	233
87 618 142	Preselection and multifunction up/down counters 48x48 - 4341-1 preset	233
87 618 144	Preselection and multifunction up/down counters 48x48 - 4341-1 preset	233
87 618 148	Preselection and multifunction up/down counters 48x48 - 4341-1 preset	233
87 618 162	Preselection and multifunction up/down counters 48x48 - 4342-2 preset	233



## Index by part number

Part numbers	Description	Page
87 618 164	Preselection and multifunction up/down counters 48x48 - 4342-2 preset	233
87 618 168	Preselection and multifunction up/down counters 48x48 - 4342-2 preset	233
87 618 172	Preselection and multifunction up/down counters 48x48 - 4344-2 preset	233
87 618 174	Preselection and multifunction up/down counters 48x48 - 4344-2 preset	233
87 618 178	Preselection and multifunction up/down counters 48x48 - 4344-2 preset	233
87 618 222	Preselection and multifunction up/down counters 48x48 - 4192-2 preset	232
87 618 224	Preselection and multifunction up/down counters 48x48 - 4192-2 preset	232
87 618 228	Preselection and multifunction up/down counters 48x48 - 4192-2 preset	232
87 618 262	Preselection and multifunction up/down counters 48x48 - 4192-2 preset	232
87 618 264	Preselection and multifunction up/down counters 48x48 - 4192-2 preset	232
87 618 268	Preselection and multifunction up/down counters 48x48 - 4192-2 preset	232
87 618 322	Preselection and multifunction up/down counters 48x48 - 4392-2 preset	233
87 618 324	Preselection and multifunction up/down counters 48x48 - 4392-2 preset	233
87 618 328	Preselection and multifunction up/down counters 48x48 - 4392-2 preset	233
87 618 362	Preselection and multifunction up/down counters 48x48 - 4392-2 preset	233
87 618 364	Preselection and multifunction up/down counters 48x48 - 4392-2 preset	233
87 618 368	Preselection and multifunction up/down counters 48x48 - 4392-2 preset	233
87 619 012	Preselection and Multifunction up/down counters 72x72 - 7141- 1 preset	236
87 619 014	Preselection and Multifunction up/down counters 72x72 - 7141- 1 preset	236
87 619 018	Preselection and Multifunction up/down counters 72x72 - 7141- 1 preset	236
87 619 022	Preselection and Multifunction up/down counters 72x72 - 7142-2 preset	236
87 619 024	Preselection and Multifunction up/down counters 72x72 - 7142-2 preset	236
87 619 028	Preselection and Multifunction up/down counters 72x72 - 7142-2 preset	236
87 619 112	Preselection and Multifunction up/down counters 72x72 - 7341-1 preset	237
87 619 114	Preselection and Multifunction up/down counters 72x72 - 7341-1 preset	237
87 619 118	Preselection and Multifunction up/down counters 72x72 - 7341-1 preset	237
87 619 122	Preselection and Multifunction up/down counters 72x72 - 7342-2 preset	237
87 619 124	Preselection and Multifunction up/down counters 72x72 - 7342-2 preset	237
87 619 128	Preselection and Multifunction up/down counters 72x72 - 7342-2 preset	237
87 619 222	Preselection and Multifunction up/down counters 72x72 - 7192-2 preset	236
87 619 224	Preselection and Multifunction up/down counters 72x72 - 7192-2 preset	236
87 619 228	Preselection and Multifunction up/down counters 72x72 - 7192-2 preset	236
87 619 322	Preselection and Multifunction up/down counters 72x72 - 7392-2 preset	237
87 619 324	Preselection and Multifunction up/down counters 72x72 - 7392-2 preset	237

Part numbers	Description	Page
87 619 328	Preselection and Multifunction up/down counters 72x72 - 7392-2 preset	237

## 88 000 000

88 225 011	DIN rail mounted - 6 s 12 min	64
88 225 012	DIN rail mounted - 6 s 12 min	64
88 225 013	DIN rail mounted - 6 s 12 min	64
88 225 014	DIN rail mounted - 6 min 12 h	64
88 225 015	DIN rail mounted - 6 min 12 h	64
88 225 016	DIN rail mounted - 6 min 12 h	64
88 225 017	DIN rail mounted - 6 min 12 h	64
88 225 019	DIN rail mounted - 6 s 12 min	64
88 226 011	Panel-mounted - 6 s 12 mm	92
88 226 012	Panel-mounted - 6 s 12 mm	92
88 226 013	Panel-mounted - 6 s 12 mm	92
88 226 014	Panel-mounted - 6 min 12 h	92
88 226 015	Panel-mounted - 6 min 12 h	92
88 226 016	Panel-mounted - 6 min 12 h	92
88 226 017	Panel-mounted - 6 min 12 h	92
88 226 019	Panel-mounted - 6 s 12 mm	92
88 226 501	Panel-mounted - 6 s 12 mm	92
88 226 502	Panel-mounted - 6 s 12 mm	92
88 226 503	Panel-mounted - 6 s 12 mm	92
88 226 504	Panel-mounted - 6 s 12 mm	92
88 226 505	Panel-mounted - 6 min 12 h	92
88 226 506	Panel-mounted - 6 min 12 h	92
88 226 507	Panel-mounted - 6 min 12 h	92
88 226 508	Panel-mounted - 6 min 12 h	92
88 256 4	Cam timers 1 circuit	282
88 256 401	Panel-mounted - 882564	96
88 256 402	Panel-mounted - 882564	96
88 256 403	Panel-mounted - 882564	96
88 256 404	Panel-mounted - 882564	96
88 256 405	Panel-mounted - 882564	96
88 256 406	Panel-mounted - 882564	96
88 256 407	Panel-mounted - 882564	96
88 256 408	Panel-mounted - 882564	96
88 256 5	Cam timers 2 circuits	282
88 256 506	Panel-mounted - 882565	96
88 256 507	Panel-mounted - 882565	96
88 256 508	Panel-mounted - 882565	96
88 256 509	Panel-mounted - 882565	96
88 256 510	Panel-mounted - 882565	96
88 256 511	Panel-mounted - 882565	96
88 256 512	Panel-mounted - 882565	96
88 256 513	Panel-mounted - 882565	96
88 256 9	Cam timers 3 circuits	282
88 256 906	Panel-mounted - 882569	96
88 256 907	Panel-mounted - 882569	96
88 256 908	Panel-mounted - 882569	96
88 256 909	Panel-mounted - 882569	96
88 256 910	Panel-mounted - 882569	96
88 256 911	Panel-mounted - 882569	96
88 256 912	Panel-mounted - 882569	96
88 256 913	Panel-mounted - 882569	96
88 645 0	Cam timers with external knob 7 circuits	274
88 645 0	Cam timers with internal knob 5 circuits	274
88 645 1	Cam timers with fast cycle-end or 2 speeds 5 circuits	274
88 645 2	Cam timers with external knob 12 circuits	274
88 645 2	Cam timers with internal knob 10 circuits	274
88 645 3	Cam timers with fast cycle-end or 2 speeds 10 circuits	274
88 645 4	Cam timers with external knob 17 circuits	274
88 645 4	Cam timers with internal knob 15 circuits	274
88 645 5	Cam timers with fast cycle-end or 2 speeds 15 circuits	274
88 645 6	Cam timers with external knob 22 circuits	274
88 645 6	Cam timers with internal knob 20 circuits	274

# Index by part number

Part numbers	Description	Page
88 645 7	Cam timers with fast cycle-end or 2 speeds 20 circuits	274
88 645 8	Cam timers with external knob 31 circuits	274
88 645 8	Cam timers with external knob 40 circuits	274
88 645 8	Cam timers with internal knob 20 circuits	274
88 645 8	Cam timers with internal knob 38 circuits	274
88 645 9	Cam timers with fast cycle-end or 2 speeds 29 circuits	274
88 645 9	Cam timers with fast cycle-end or 2 speeds 38 circuits	274
88 646 0	Cam timers 2 circuits	278
88 646 2	Cam timers 4 circuits	278
88 650	Cam timers with fully precut cams and selector knob	277
88 650 3	Cam timers 6 circuits	276
88 650 4	Cam timers 8 circuits	276
88 650 5	Cam timers 10 circuits	276
88 650 6	Cam timers 12 circuits	276
88 650 7	Cam timers 14 circuits	276
88 650 8	Cam timers 16 circuits	276
88 650 9	Cam timers 18 circuits	276
88 650 9	Cam timers 20 circuits	276
88 650 9	Cam timers 22 circuits	276
88 655 1	Cam timers 1 circuit	280
88 655 2	Cam timers 2 circuits	280
88 826 004	Chronos 2 - MUS2	36
88 826 014	Chronos 2 - MAS5	36
88 826 044	Chronos 2 - MHS2	36
88 826 054	Chronos 2 - MLS2	36
88 826 100	Chronos 2 - MUR4	36
88 826 103	Chronos 2 - MUR3	36
88 826 105	Chronos 2 - MUR1	36
88 826 115	Chronos 2 - MAR1	36
88 826 125	Chronos 2 - MBR1	36
88 826 135	Chronos 2 - MCR1	36
88 826 145	Chronos 2 - MHR1	36
88 826 155	Chronos 2 - MLR1	36
88 826 185	Chronos 2 - MXR1	36
88 826 503	Chronos 2 - MURc3	36
88 857 003	Digital - Timer 814	82
88 857 005	Digital - Timer 814	82
88 857 103	Digital - Timer 814	82
88 857 105	Digital - Timer 814	82
88 857 301	Digital - Timer 815	82
88 857 302	Digital - Timer 815	82
88 857 307	Digital - Timer 815	82
88 857 400	Digital - Timer 812	82
88 857 406	Digital - Timer 812	82
88 857 409	Digital - Timer 812	82
88 857 502	Digital TOP 948 - TOP 948	78
88 857 504	Digital TOP 948 - TOP 948	78
88 857 508	Digital TOP 948 - TOP 948	78
88 857 601	Digital 816 - Timer 816	86
88 857 604	Digital 816 - Timer 816	86
88 857 607	Digital 816 - Timer 816	86
88 857 701	Digital 816 - Timer 816	86
88 857 704	Digital 816 - Timer 816	86
88 857 707	Digital 816 - Timer 816	86
88 865 100	Chronos 2 - TUR4	38
88 865 103	Chronos 2 - TUR3	38
88 865 105	Chronos 2 - TUR1	38
88 865 115	Chronos 2 - TAR1	38
88 865 125	Chronos 2 - TBR1	38
88 865 135	Chronos 2 - TCR1	38
88 865 145	Chronos 2 - THR1	38
88 865 155	Chronos 2 - TLR1	38
88 865 175	Chronos 2 - TQR1	38
88 865 176	Chronos 2 - TQR6	38
88 865 185	Chronos 2 - TXR1	38
88 865 215	Chronos 2 - TA2R1	38
88 865 265	Chronos 2 - TK2R1	38

Part numbers	Description	Page
88 865 300	Chronos 2 - TU2R4	38
88 865 303	Chronos 2 - TU2R3	38
88 865 305	Chronos 2 - TU2R1	38
88 865 385	Chronos 2 - TX2R1	38
88 865 503	Chronos 2 - TURc3	38
88 867 100	Chronos 2 - OUR4	42
88 867 103	Chronos 2 - OUR3	42
88 867 105	Chronos 2 - OUR1	42
88 867 135	Chronos 2 - OCR1	42
88 867 155	Chronos 2 - OLR1	42
88 867 215	Chronos 2 - OA2R1	42
88 867 300	Chronos 2 - PU2R4	42
88 867 303	Chronos 2 - PU2R3	42
88 867 305	Chronos 2 - PU2R1	42
88 867 415	Chronos 2 - PA2R1	42
88 867 435	Chronos 2 - PC2R1	42
88 867 455	Chronos 2 - PL2R1	42
88 886 016	Analogue TMR 48 - TMR 48 U	74
88 886 106	Analogue TMR 48 - TMR 48 A	74
88 886 116	Analogue TMR 48 - TMR 48 X	74
88 886 516	Analogue TMR 48 - TMR 48 L	74
88 895 201	Miniature - RTMA2	46
88 895 202	Miniature - RTMA2	46
88 895 203	Miniature - RTMA2	46
88 895 206	Miniature - RTMA2	46
88 895 207	Miniature - RTMA2	46
88 896 201	Miniature - RTMA4	46
88 896 202	Miniature - RTMA4	46
88 896 203	Miniature - RTMA4	46
88 896 206	Miniature - RTMA4	46
88 896 207	Miniature - RTMA4	46
88 899 204	Defrost relay for air conditioning and industrial refrigeration - NFR	62
88 901 302	MBA (Ø 22 mm) - MIN BOU	90
88 901 308	MBA (Ø 22 mm) - MBA2F	90
88 901 322	MBA (Ø 22 mm) - MIN BOU	90
88 901 328	MBA (Ø 22 mm) - MBA2F	90
88 901 342	MBA (Ø 22 mm) - MIN BOU	90
88 901 348	MBA (Ø 22 mm) - MBA2F	90
88 901 372	MBA (Ø 22 mm) - MIN BOU	90
88 901 378	MBA (Ø 22 mm) - MBA2F	90
88 901 392	MBA (Ø 22 mm) - MIN BOU	90
88 901 398	MBA (Ø 22 mm) - MBA2F	90
88 950 001	Millenium II - CN 12	19
88 950 002	Millenium II - CN 12	19
88 950 003	Millenium II - CN 12	19
88 950 004	Millenium II - CN 12	19
88 950 005	Millenium II - CN 12	19
88 950 006	Millenium II - CN 12	19
88 950 009	Millenium II - CN 12	19
88 950 011	Millenium II - CN 20	19
88 950 012	Millenium II - CN 20	19
88 950 013	Millenium II - CN 20	19
88 950 014	Millenium II - CN 20	19
88 950 015	Millenium II - CN 20	19
88 950 016	Millenium II - CN 20	19
88 950 019	Millenium II - CN 20	19
88 950 021	Millenium II - EC12	18
88 950 022	Millenium II - EC12	18
88 950 023	Millenium II - EC12	18
88 950 024	Millenium II - EC12	18
88 950 025	Millenium II - EC12	18
88 950 026	Millenium II - EC12	18
88 950 029	Millenium II - EC12	18
88 950 031	Millenium II - EC 20	18
88 950 032	Millenium II - EC 20	18
88 950 033	Millenium II - EC 20	18
88 950 034	Millenium II - EC 20	18
88 950 035	Millenium II - EC 20	18
88 950 036	Millenium II - EC 20	18
88 950 039	Millenium II - EC 20	18

## Index by part number

Part numbers	Description	Page	Part numbers	Description	Page
88 950 041	Millenium II - SA 12	16	89 420 207	Analogue temperature controllers - CT48A	210
88 950 042	Millenium II - SA 12	16	89 420 217	Analogue temperature controllers - CT48A	210
88 950 043	Millenium II - SA 12	16	89 420 227	Analogue temperature controllers - CT48A	210
88 950 044	Millenium II - SA 12	16	89 420 237	Analogue temperature controllers - CT48A	210
88 950 045	Millenium II - SA 12	16	89 420 257	Analogue temperature controllers - CT48A	210
88 950 046	Millenium II - SA 12	16	89 421 102	Temperature controllers CTH/CTD - CTD 43	216
88 950 049	Millenium II - SA 12	16	89 421 108	Temperature controllers CTH/CTD - CTD 43	216
88 950 051	Millenium II - SA 20	16	89 421 112	Temperature controllers CTH/CTD - CTD 43	216
88 950 052	Millenium II - SA 20	16	89 421 118	Temperature controllers CTH/CTD - CTD 43	216
88 950 053	Millenium II - SA 20	16	89 422 002	Digital temperature controllers MIC 48 - Without RS 485 link	212
88 950 054	Millenium II - SA 20	16	89 422 008	Digital temperature controllers MIC 48 - Without RS 485 link	212
88 950 055	Millenium II - SA 20	16	89 422 012	Digital temperature controllers MIC 48 - Without RS 485 link	212
88 950 056	Millenium II - SA 20	16	89 422 018	Digital temperature controllers MIC 48 - Without RS 485 link	212
88 950 059	Millenium II - SA 20	16	89 422 102	Temperature controllers CTH/CTD - CTD 46	216
88 950 061	Millenium II - XT 20	17	89 422 108	Temperature controllers CTH/CTD - CTD 46	216
88 950 062	Millenium II - XT 20	17	89 422 112	Temperature controllers CTH/CTD - CTD 46	216
88 950 063	Millenium II - XT 20	17	89 422 118	Temperature controllers CTH/CTD - CTD 46	216
88 950 064	Millenium II - XT 20	17	89 422 402	Digital temperature controllers MIC 48 - With RS 485 link	212
88 950 065	Millenium II - XT 20	17	89 422 408	Digital temperature controllers MIC 48 - With RS 485 link	212
88 950 066	Millenium II - XT 20	17	89 422 412	Digital temperature controllers MIC 48 - With RS 485 link	212
88 950 069	Millenium II - XT 20	17	89 422 418	Digital temperature controllers MIC 48 - With RS 485 link	212
88 950 070	Millenium II - KIT SA 12	14	89 422 502	Temperature controllers CTH/CTD - CTH 46	216
88 950 071	Millenium II - KIT SA 12	14	89 422 508	Temperature controllers CTH/CTD - CTH 46	216
88 950 072	Millenium II - Kit SA 20	14	89 422 512	Temperature controllers CTH/CTD - CTH 46	216
88 950 073	Millenium II - Kit SA 20	14	89 422 518	Temperature controllers CTH/CTD - CTH 46	216
88 950 074	Millenium II - Kit XT 20	14	89 422 702	Temperature controller/indicator CTD 24 - CTD 24	219
88 950 075	Millenium II - Kit XT 20	14	89 422 708	Temperature controller/indicator CTD 24 - CTD 24	219
88 950 100	Millenium II - Programming software on CD ROM	23	89 422 712	Temperature controller/indicator CTD 24 - CTD 24	219
88 950 101	Millenium II - EEPROM memory module	23	89 422 718	Temperature controller/indicator CTD 24 - CTD 24	219
88 950 102	Millenium II - PC-module link interface	23	89 422 722	Temperature controller/indicator CTD 24 - CTD 24	219
88 950 103	Accessories - Software	23	89 422 728	Temperature controller/indicator CTD 24 - CTD 24	219
88 950 105	Programming cable USB	23	89 750 103	Accessories - Front panel adaptor	23
88 950 106	Millenium II - Modems	21	89 750 109	Accessories - Front panel adaptor	23
88 950 107	Millenium II - Modems	21	89 750 146	Temperature sensors - Copper protective sleeve for 89 750 153	24
88 950 111	Modem cable	23	89 750 147	Temperature sensors - Stainless steel (316) protective sleeve for 89 750 153	24
88 950 112	Accessories - Convertor PWM / 0-10V	23	89 750 150	Temperature sensors - Zone	24
88 950 113	Accessories - Software	23			
88 950 108	Accessories - Convertor 0-20 mA / 0-10 V	23			
88 950 200	Millenium II - XL 01	20			
88 950 204	Millenium II - XL 05	20			
88 950 210	Millenium II - XC 01	20			
88 950 211	Millenium II - XC 01	20			
88 950 212	Millenium II - XC 01	20			
88 950 213	Millenium II - XC 01	20			
88 950 214	Millenium II - XC 01	20			
88 950 215	Millenium II - XC 01	20			
88 950 219	Millenium II - XC 01	20			
88 950 810	Millenium II - XL 06	20			
88 950 813	Millenium II - SA 12 + level sensor adaptor	15			
88 950 831	Millenium II - EX 20	17			
88 950 832	Millenium II - EX 20	17			
88 950 833	Millenium II - EX 20	17			
88 950 834	Millenium II - EX 20	17			
88 950 839	Millenium II - EX 20	17			
<b>89 000 000</b>					
89 420 047	Analogue temperature controllers - CT48A	210			
89 420 067	Analogue temperature controllers - CT48A	210			
89 420 077	Analogue temperature controllers - CT48A	210			
89 420 087	Analogue temperature controllers - CT48A	210			
89 420 097	Analogue temperature controllers - CT48A	210			

## Index by part number

Part numbers	Description	Page
89 750 151	Temperature sensors - Ventilation duct	24
89 750 152	Temperature sensors - Outdoor	24
89 750 153	Temperature sensors - Remote/submersible probe	24
89 750 155	Temperature sensors - Outdoor	24
89750160	Accessories - Front panel adaptor	23
89750161	Accessories - Front panel adaptor	23
89750162	Accessories - Front panel adaptor	23

### 99 000 000

99 761 710	Electro-mechanical hour counter CH 48 G - CH 48 G	266
99 761 711	Electro-mechanical hour counter CH 48 G - CH 48 G	266
99 761 712	Electro-mechanical hour counter CH 48 G - CH 48 G	266
99 761 714	Electro-mechanical hour counter CH 48 G - CH 48 G	266
99 761 715	Electro-mechanical hour counter CH 48 G - CH 48 G	266
99 761 716	Electro-mechanical hour counter CH 48 G - CH 48 G	266
99 761 718	Electro-mechanical hour counter CH 48 G - CH 48 G	266
99 766 601	Electro-mechanical impulse counters totalizing - 36 x 37 - Without zero reset	260
99 766 602	Electro-mechanical impulse counters totalizing - 36 x 37 - Without zero reset	260
99 766 604	Electro-mechanical impulse counters totalizing - 36 x 37 - Without zero reset	260
99 766 607	Electro-mechanical impulse counters totalizing - 36 x 37 - Without zero reset	260
99 766 610	Electro-mechanical impulse counters totalizing - 36 x 37 - With zero reset	260
99 766 611	Electro-mechanical impulse counters totalizing - 36 x 37 - With zero reset	260
99 766 613	Electro-mechanical impulse counters totalizing - 36 x 37 - With zero reset	260
99 766 616	Electro-mechanical impulse counters totalizing - 36 x 37 - With zero reset	260
99 766 701	Electro-mechanical impulse counters totalizing - 36 x 48 - Without zero reset	264
99 766 702	Electro-mechanical impulse counters totalizing - 36 x 48 - Without zero reset	264
99 766 704	Electro-mechanical impulse counters totalizing - 36 x 48 - Without zero reset	264
99 766 707	Electro-mechanical impulse counters totalizing - 36 x 48 - Without zero reset	264
99 766 710	Electro-mechanical impulse counters totalizing - 36 x 48 - Without zero reset (manual)	264
99 766 711	Electro-mechanical impulse counters totalizing - 36 x 48 - Without zero reset (manual)	264
99 766 713	Electro-mechanical impulse counters totalizing - 36 x 48 - Without zero reset (manual)	264
99 766 716	Electro-mechanical impulse counters totalizing - 36 x 48 - Without zero reset (manual)	264
99 766 901	Electro-mechanical impulse counters totalizing - 24 x 48 - Without zero reset	262
99 766 902	Electro-mechanical impulse counters totalizing - 24 x 48 - Without zero reset	262
99 766 904	Electro-mechanical impulse counters totalizing - 24 x 48 - Without zero reset	262
99 766 907	Electro-mechanical impulse counters totalizing - 24 x 48 - Without zero reset	262

Part numbers	Description	Page
99 766 921	Electro-mechanical impulse counters totalizing - 24 x 48 - With zero reset (manual)	262
99 766 922	Electro-mechanical impulse counters totalizing - 24 x 48 - With zero reset (manual)	262
99 766 924	Electro-mechanical impulse counters totalizing - 24 x 48 - With zero reset (manual)	262
99 766 927	Electro-mechanical impulse counters totalizing - 24 x 48 - With zero reset (manual)	262





## Conditions of sale

### 1. Acceptance

All orders are accepted subject to the following Conditions of Sale which cannot be varied except expressly and in writing by us. These terms and conditions shall prevail over any terms and conditions contained in a purchaser's order. Any sale by us to purchaser subsequent to an order or other notification incorporating any Conditions of Purchase of the Purchaser shall not be deemed to constitute an acceptance by us of the purchaser's Conditions of Purchase.

### 2. Prices and discounts

All prices and discount rates are subject to alteration without notice and the rate applicable to a particular order will be our price and discount rates current at the date of despatch irrespective of the price and discount rate stated in our acknowledgement. Minimum order charge payable.

### 3. Payment

Payment must be made with the order in cash without any deduction (other than any discount rate previously agreed by us) unless monthly or other terms have been approved by us prior to the order being made.

### 4. Despatch dates

Despatch dates given are based on our best information at the time quoted, but are given as estimates only. We reserve the right to postpone any quoted despatch or delivery dates without prior notice and without liability for any delay. Delivery weeks are numbered 1-52 from January to December.

### 5. Cancellation or amendment

We reserve the right to cancel or amend a purchaser's order if it is impractical or impossible for us to fulfil the order by reason of any act of God, war, civil disturbance, strike, lockout, cessation of work, combination of workmen or employees, legislation or restriction of any governmental or other authority, breakdown or interruption of transport, force majeure or any other circumstances beyond our control and in such circumstances the obligations of each part hereunder shall be wholly or partially suspended during the continuance and to the extent of such prevention, interruption or hindrance.

### 6. Descriptions

Technical information relating to our products as set out in our catalogue(s) and description literature may be varied by us from time to time due to manufacturing and other factors. Every effort will be made to keep our literature and catalogues up-to-date but the purchaser should make specific enquiries and satisfy himself that any order given by him is of products and specifications currently available, and supplied by us at the time the order is given. Every endeavour will be made by us to correct and up-date our literature from time to time as the situation shall require but we accept no liability for minor or trifling misdescription.

### 7. Delivery complaints

Non delivery within 10 days of the date of despatch must be reported immediately in writing to us and to the carriers. Any damage or shortfall in delivery must be reported in writing to us within three days of delivery giving a statement of the alleged shortfall or damage. We shall not be liable for any claims in respect of the above complaints unless they have been reported in accordance with this Clause.

### 8. Warranty

We shall repair or, at our option, replace without charge any products manufactured and supplied by us hereunder which prove defective within twelve months from the date of despatch PROVIDED ALWAYS, that

- a) such products have not been structurally modified or misused or misapplied;
  - b) they are returned to us carriage paid;
  - c) all terms agreed by us for payment of such goods have been strictly complied with;
  - d) any claim hereunder is made within 30 days of the date of discovery of the defect.
- PROVIDED THAT this Warranty shall not extend to any prototype(s) nor any pre-production batch supplied for customer evaluation. Where it appears to us following an inspection of the return of goods that no defect rendering the goods unmerchantable or fit for their purpose exists or has existed since despatch by us we shall be entitled at our absolute discretion to return the goods henceforth to the buyer who shall thereupon bear and be responsible for cost of carriage thereby incurred.

Save as provided above we accept no liability in contract or tort whatsoever in respect of defects in goods sold by us save where such liability cannot be limited or excluded in law.

### 9. Errors

We reserve the right to correct all typographical and clerical errors and the purchaser may not rely on any such information thus erroneously provided.

### 10. Proper law

The parties hereby agree that any contract made between them and any question thereby arising shall be governed by English law.

### 11. Intellectual property

The purchaser hereby agrees and undertakes not to copy, publicise or make available to any third party any drawings, designs, patterns, tooling written instructions, software specifications etc produced and supplied by us in connection with any order placed under these conditions save in accordance with any licence granted by us and it is hereby agreed that the same shall remain our property and must be returned to us on demand free of charge. Where software is incorporated in our product and sold to the purchaser as a package the software remains our property and the purchaser has a no-exclusive right of use.

As a consequence, the purchaser is forbidden to reproduce, except for the purchaser's own security copy purposes, alter or publish such software as is marketed by us or otherwise inform unauthorised persons.

### 12. Title

We retain ownership in the goods until full payment has been made and goods supplied that have not been paid for must be held by the purchaser on our behalf as follows :

- a) It shall be the duty of the purchaser to preserve and store goods delivered in an identifiable form and not to mix or make the said goods until payment is received by us in full, unless written consent is otherwise given. Further if such written consent is given, it is agreed that you will hold the proceeds of sale on trust for us in a separate identifiable bank account until the payment is made in full.
- b) It is further hereby agreed that in the event of the purchaser becoming bankrupt or having a Receiving Order or Administration Order made or making arrangements with creditors for commencing to be wound up then the purchaser will notify us forthwith and we shall be entitled to give notices and instructions to the purchaser in accordance with clause (a) above. Nothing in this sub-clause shall prejudice our rights with regard to clause (a) above.

### 13. Minimum order charge

£100 (excluding Post and Packing)+VAT. Orders for less than £100 will be charged as £100. VAT will be added at the relevant rate.



# Crouzet around the world

## AUSTRIA

Crouzet GmbH  
Spengergasse 1/3  
A-1050 Wien  
Tel. : +43(0)1/3685471  
Fax : +43(0)1/3685472  
E-mail : com-at@crouzet.com  
www.crouzet.at

### Customer services

Tel. : +49(0)21 03/9 80-1 71 und 1 08  
Fax : +49(0)21 03/9 80-2 50  
E-mail : com-at@crouzet.com

## BELGIUM

Crouzet NV/SA  
Koning Albert I Laan 40  
1780 Wemmel  
Tel. : +32 (0)2 462 07 30  
Fax : +32 (0)2 461 00 23  
E-mail : com-be@crouzet.com  
www.crouzet.be

### Customer services

Tel. : +33 825 333 350 (FR)  
Tel. : +33 475 802 104 (NL)  
Fax : +33 475 802 120  
E-mail : infocom@crouzet.com

## BRAZIL

Crouzet do Brasil  
Rua Antonio das Chagas, 945  
Chacara Santo Antonio  
CEP 04714-001 Sao Paulo -SP  
Tel. : + 55 11 51 80 36 22  
E-mail : com-dvi@crouzet.com  
www.crouzet.com

### Customer services

Tel. : +33 475 802 102  
Fax : +33 475 802 120  
E-mail : infocom@crouzet.com

## CHINA

Crouzet Asia  
Dynasty Business Center, 310-3F  
457 Wu Lu Mu Qi (N) Road  
SHANGHAI  
Tel. : +(86-21) 62 49 09 10  
Fax : +(86-21) 62 49 07 01  
E-mail : com-cn@crouzet.com  
www.crouzet.com

### Customer Services

Tel. : +33 475 802 102  
Fax : +33 475 802 120  
E-mail : infocom@crouzet.com

## CZECH REPUBLIC

Crouzet GmbH  
Otto-Hahn Str.3  
D-40721 Hilden  
Postfach 203  
D-40702 Hilden  
Tel. : +49(0)21 03 9 80-0  
Fax : +49(0)21 03 9 80-2 00  
E-mail : com-cz@crouzet.com  
www.crouzet.de

### Customer services

Tel. : +49(0)21 03/9 80-1 71 und 1 08  
Fax : +49(0)21 03/9 80 2 50  
E-mail : com-cz@crouzet.com

## FRANCE

Crouzet Automatismes SAS  
Ventes France  
2 rue du docteur Abel - BP 59  
26 902 Valence cedex 9  
Tel. : 04 75 44 88 44  
Fax N° Azur 0 810 61 01 02  
E-mail : com-fr@crouzet.com  
www.crouzet.fr

### Customer services

N° Indigo 0 825 33 33 50  
Fax : 04 75 80 21 20  
E-mail : infocom@crouzet.com

## GERMANY

Crouzet GmbH  
Otto-Hahn Str.3  
D-40721 HILDEN  
Postfach 203  
D-40702 HILDEN  
Tel. : +49(0)21 03 9 80-0  
Fax : +49(0)21 03 9 80-2 00  
E-mail : com-de@crouzet.com  
www.crouzet.de

### Customer services

Tel. : +49(0)21 03 9 80-1 55  
Fax : +49(0)21 03 9 80-2 50  
E-mail : com-de@crouzet.com

## HONG-KONG

Crouzet Asia Ltd  
Suite 4512, 45/F, Tower 2,  
Metro Plaza  
223 Hing Fong Road  
Kwai Chung, N.T. Hong Kong  
Tel. : +852 2418 2118  
Fax : +852 2424 7978  
E-mail : com-cn@crouzet.com  
www.crouzet.com

### Customer services

Tel. : +33 475 802 102  
Fax : +33 475 802 120  
E-mail : infocom@crouzet.com

## HUNGARY

Crouzet GmbH  
Otto-Hahn-Str. 3  
D-40721 Hilden  
Postfach 203  
D-40702 Hilden  
Tel. : +49(0)21 03 9 80-0  
Fax : +49(0)21 03 9 80-2 00  
E-mail : com-hu@crouzet.com  
www.crouzet.hu

### Customer services

Tel. : +49(0)21 03/9 80-1 71 und 1 08  
Fax : +49(0)21 03/9 80-2 50  
E-mail : com-hu@crouzet.com

## INDIA

Crouzet India  
India liaison office  
Unit No. 3-D, "SPL ENDERLY"  
III Floor, 26, Cubbon road  
BANGALORE 560 001  
Tel. : +91 80 30611862  
Fax : +91 80 51238066  
E-mail : crz\_bangalore@crouzet.com  
www.crouzet.com

### Customer services

Tel. : +33 475 802 102  
Fax : +33 475 802 120  
E-mail : infocom@crouzet.com

## ITALY

Crouzet Componenti s.r.l.  
Via Brembo, 23  
20139 Milano  
Tel. : +39 02 57 306 611  
Fax : +39 02 57 306 723  
E-mail : com-it@crouzet.com  
www.crouzet.com

## MEXICO

Crouzet Mexicana SA  
Aguiles Serdan n° 416  
San Felipe Hueyotlilan C.P.  
72030 - Puebla Mexico  
Tel. : +52 22 24 20 29/ 30  
Fax : +52 22 24 21 47  
E-mail : com-mx@crouzet.com  
www.crouzet.com

### Customer services

Tel. : +33 475 802 103  
Fax : +33 475 802 120  
E-mail : infocom@crouzet.com

## POLAND

Crouzet GmbH  
Ul. Ryżowa 2  
PL-02-483 Warszawa  
Tel. : +48(0)22/8734080  
Fax : +48(0)22/8734081  
E-mail : com-pl@crouzet.com  
www.crouzet.pl

### Customer services

Tel. : +49(0)21 03/9 80-1 71 und 1 08  
Fax : +49(0)21 03/9 80-2 50  
E-mail : com-pl@crouzet.com

## SPAIN

Crouzet España  
C/ Aragón 224, 2° - 2ª  
08011 Barcelona  
Tel. : +34 93 484 31 00  
Fax : +34 93 484 39 73  
E-mail : es-consultas@crouzet.es  
www.crouzet.es

### Customer services

Tel. : +33 475 802 103  
Fax : +33 475 802 120  
E-mail : infocom@crouzet.com

## SWEDEN

Crouzet AB  
Malmgårdsvägen 63  
Box 11183 - SE. 100 61 Stockholm  
Tel. : +46-8 556 02 200  
Fax : +46-8 556 02 229  
E-mail : crouzet@crouzet.se  
www.crouzet.se

### Customer services

Denmark, Finland, Norway and Sweden  
Tel. : +46-8-556 02 210  
Fax : +46-8 556 02 229  
E-mail : order@crouzet.se

## SWITZERLAND

Crouzet AG  
Gewerbepark - Postfach 56  
CH-5506 Mägenwil  
Tel. : +41(0)62/887 30 30  
Fax : +41(0)62/887 30 40  
E-mail : com-ch@crouzet.com  
www.crouzet.ch

### Customer services

Tel. : +41(0)62/887 30 30  
Fax : +41(0)62/887 30 40  
E-mail : com-ch@crouzet.com

## THE NETHERLANDS

Crouzet BV  
Industrieweg 17  
2382 NR Zoeterwoude  
Tel. : +31 (0)71-581 20 30  
Fax : +31 (0)71-541 35 74  
E-mail : com-nl@crouzet.com  
www.crouzet.nl

### Customer Services

Tel. : +33 475 802 104  
Fax : +33 475 802 120  
E-mail : infocom@crouzet.com

## UNITED KINGDOM

Crouzet Ltd  
Intec 3 - Wade Road  
Basingstoke - Hampshire  
RG24 8NE  
Tel. : +44 (0)1256 318 900  
Fax : +44 (0)1256 318 901  
E-mail : info@crouzet.co.uk  
www.crouzet.co.uk

## USA

Crouzet Corporation  
204 Airline drive, suite 300  
Coppell Texas 75019  
Tel. : +1 972 471-2555  
Fax : +1 972 471-2560  
E-mail : com-us@crouzet.com  
www.crouzet-usa.com

### Customer Services

Tel. : +33 475 802 102  
Fax : +33 475 802 120  
E-mail : infocom@crouzet.com

## OTHER COUNTRIES

Crouzet Automatismes SAS  
Division Ventes Internationales  
2, rue du docteur Abel - BP 59  
26902 Valence cedex 9 - Fr.  
Tel. : +33 475 448 936  
Fax : +33 475 448 105  
E-mail : com-dvi@crouzet.com  
www.crouzet.com

### Customer services

Tel. : +33 475 802 102  
Fax : +33 475 802 120  
E-mail : infocom@crouzet.com

### **Warning:**

The product information contained in this catalogue is given purely as information and does not constitute a representation, warranty or any form of contractual commitment. CROUZET Automatismes and its subsidiaries reserve the right to modify their products without notice. It is imperative that we should be consulted over any particular use or application of our products and it is the responsibility of the buyer to establish, particularly through all the appropriate tests, that the product is suitable for the use or application. Under no circumstances will our warranty apply nor shall we be held responsible for any application (such as any modification, addition, deletion, use in conjunction with other electrical or electronic components, circuits or assemblies, or any other unsuitable material or substance) which has not been expressly agreed by us prior to the sale of our products.

Distributed by :

