

NP 24-12

RELIABILITY IS YOUR SECURITY

Utilizing the latest advance design Oxygen Recombination Technology, Yuasa have applied their 80 years experience in the lead acid battery field to produce the optimum design of Sealed Lead Acid batteries.

FEATURES

- + Superb recovery from deep discharge
- + Electrolyte suspension system
- + Gas Recombination
- + Multipurpose: Float or Cyclic use
- + Usable in any orientation
- + Superior energy density.
- + Lead calcium grids for extended life.
- + Manufactured World wide.
- + Application specific designs.

TECHNICAL FEATURES

Sealed Construction

Yuasa's unique construction and sealing technique ensures no electrolyte leakage from case or terminals.

Electrolyte Suspension System

All NP batteries utilize Yuasa's unique electrolyte suspension system incorporating a microfine glass mat to retain the maximum amount of electrolyte in the cells. The electrolyte is retained in the separator material and there is no free electrolyte to escape from the cells. No gels or other contaminants are added.

Control of Gas Generation

The design of Yuasa's NP batteries incorporates the very latest oxygen recombination technology to effectively control the generation of gas during normal use.

TERMINALS

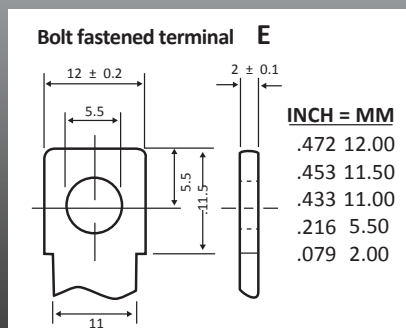

Low Maintenance Operation

Due to the perfectly sealed construction and the recombination of gasses within the cell, the battery is almost maintenance free.

Terminals

NP batteries are manufactured using a range of terminals which vary in size and type. Please refer to details as shown.

Operation in any Orientation

The combination of sealed construction and Yuasa's unique electrolyte suspension system allows operation in any orientation, with no loss of performance or fear of electrolyte leakage.

Valve Regulated Design

The batteries are equipped with a simple, safe, low pressure venting system which releases excess gas and automatically reseals should there be a build up of gas within the battery due to severe overcharge. Note. On no account should the battery be charged in a sealed container.

LAYOUT

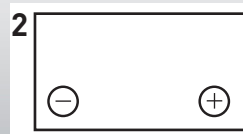

GENERAL SPECIFICATIONS

Nominal Capacity (Ah)	NP 24-12
20hr to 1.75vpc 30°C	24
10hr to 1.75vpc 20°C	22.3
5hr to 1.70vpc 20°C	20.4
1hr to 1.60vpc 20°C	14.4
Voltage	12
Energy Density (Wh.L.20hr)	79
Specific Energy (Wh.kg.20hr)	32
Int. Resistance (m.Ohms)	9.5
Maximum discharge (A)	240
Short Circuit current (A)	500
Dimensions (mm)	
Length	166
Width	175
Height overall	125
Weight (Kg)	9
Terminal	E
Layout	2
Terminal Torque Nm	2.45





NP SERIES - NP 24-12

GENERAL PURPOSE BATTERIES

LEAD CALCIUM GRIDS

The heavy duty lead calcium alloy grids provide an extra margin of performance and life in both cyclic and float applications and give unparalleled recovery from deep discharge.

LONG CYCLE SERVICE LIFE

Depending upon the average depth of discharge, over a thousand discharge/charge cycles can be expected.

FLOAT SERVICE LIFE

The expected service life is five years in float standby applications.

SEPARATORS

The use of the special separator material provides a very efficient insulation between plates preventing inter-plate short circuits and prohibiting the shedding of active materials.

LONG SHELF LIFE

The extremely low self discharge rate allows the battery to be stored for extended periods up to one year at normal ambient temperatures with no permanent loss of capacity.

OPERATING TEMPERATURE RANGE

The batteries can be used over a broad temperature range permitting considerable flexibility in system design and location.

Charge – 15°C to 50°C

Discharge – 20°C to 60°C

Storage – 20°C to 50°C (fully charged battery)

CYCLIC RECHARGE REGIME

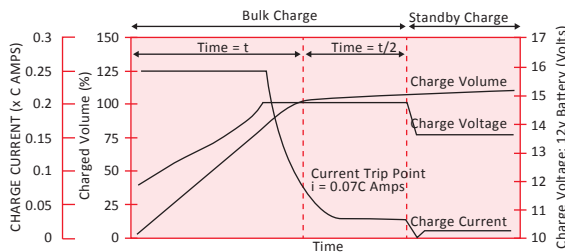

NP DISCHARGE CHARACTERISTICS CURVES AT 25°C (77°F)

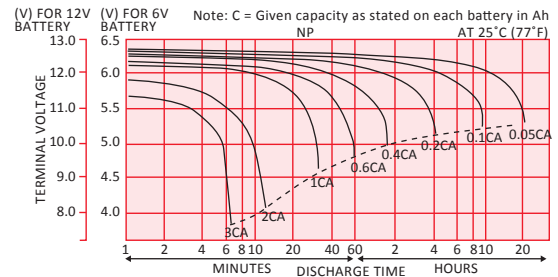

FLOAT SERVICE LIFE NP RANGE

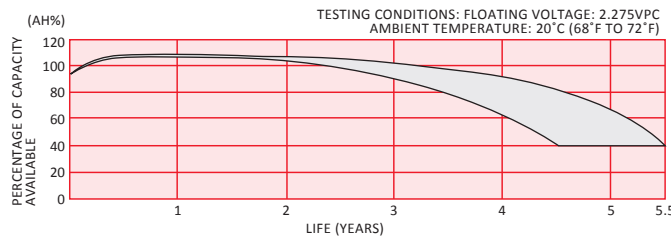

SELF DISCHARGE CHARACTERISTICS

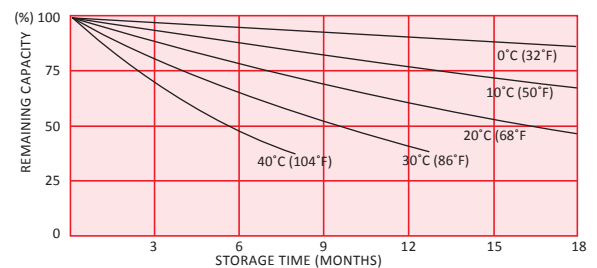

FLOAT CHARGE CHARACTERISTICS

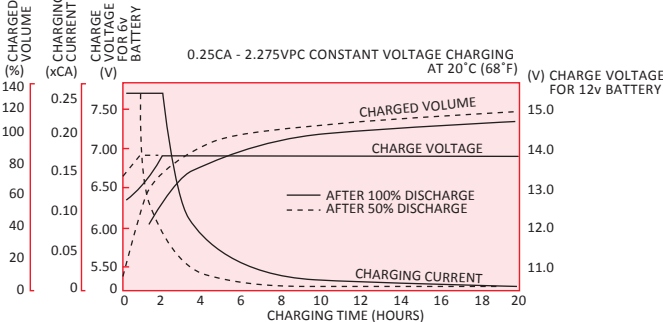

TYPICAL DISCHARGE CHARACTERISTICS NP RANGE

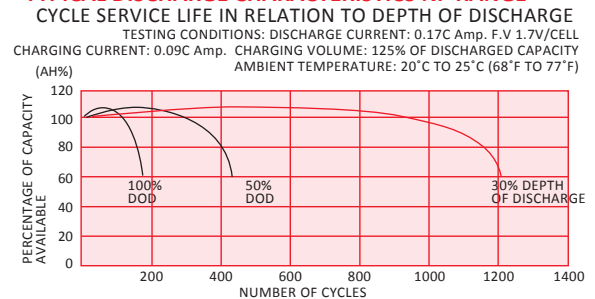

ABOUT GS YUASA ENERGY SOLUTIONS, INC.

GS Yuasa Energy Solutions, Inc. is an American subsidiary of GS Yuasa Corporation, the world's second largest battery company and a 100+ year old Japanese corporation. GS Yuasa Energy Solutions (GYES) was formed in 2019 to address the growing energy storage and reserve power markets. GYES brings together and leverages GS Yuasa Group's advanced technologies with proven American market successes in lithium, telecom, UPS, alarm & security, and energy storage into a single business unit.



GS Yuasa Energy Solutions, Inc.
1150 Northmeadow Pkwy, Suite 110
Roswell, GA 30076 (800) 472-2879
www.gsyuasa-es.com

