



SPECIFICATION SHEET

SPECIFICATION SHEET NO.	P1110- YS32K76800S100
DATE	Nov. 11, 2022
REVISION	A0
DESCRIPTION	<p>KHz SMD Crystals, L2.0*W1.2*H0.6mm, 2 Pads, CCMS series 32.76800KHz, +/-20ppm, CL 12.5pF Operating Temp. Range -40°C ~+85°C, ESR 90 Kohm Max, Reflow Profile Condition 260 °C Max. Tape/Reel, 3000pcs/Reel, RoHS/RoHS III compliant</p>
CUSTOMER	
CUSTOMER PART NUMBER	
CROSS REF. PART NUMBER	
ORIGINAL PART NUMBER	TGS CCMS 32K768A20-12.5-40-90T LF
PART CODE	YS32K76800S100

VENDOR APPROVE			
Issued/Checked/Approved			
DATE: Nov. 11, 2022			

CUSTOMER APPROVE	
DATE:	

11/10/2022

KHZ SMD CRYSTALS CCMM SERIES 2012 TYPE

MAIN FEATURE

- SMD Package, CCMM Series, L2.0*W1.2*H0.6mm, 2 Pads
- Industry standard, Operating Temp. Range -40°C ~+85°C
- Reflow Profile Condition 260 °C Max.
- Cross more competitors part
- RoHS/RoHS III compliant



APPLICATION

- Small communications devices and more

PART CODE GUIDE

RFQ

[Request For Quotation](#)

YS	32K76800	S	100
1	2	3	4

1) YS: Part family Code for KHz SMD crystal L2.0*W1.2*H0.6mm, 2 Pads, CCMS series

2) 32K76800: Frequency range code for 32.76800KHz

3) S: SMD type, Package Tape/Reel, 3000pcs/Reel

4) 100: Specification code for original part No.: **TGS CCMS 32K768A20-12.5-40-90T LF**

KHZ SMD CRYSTALS CCMM SERIES 2012 TYPE

DIMENSION (Unit: mm)

Image for reference



CCMS

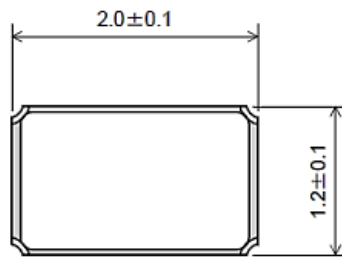

Marking
Frequency Range

or

Marking
Internal Control Code

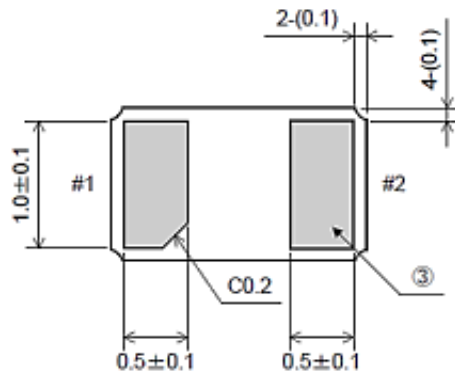

Pad Connections
#1: In/Out
#: Out/In

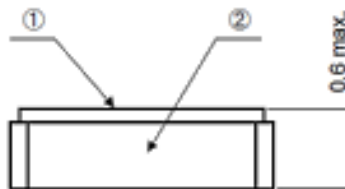

KHZ SMD CRYSTALS CCMM SERIES 2012 TYPE

PRODUCT STRUCTURE

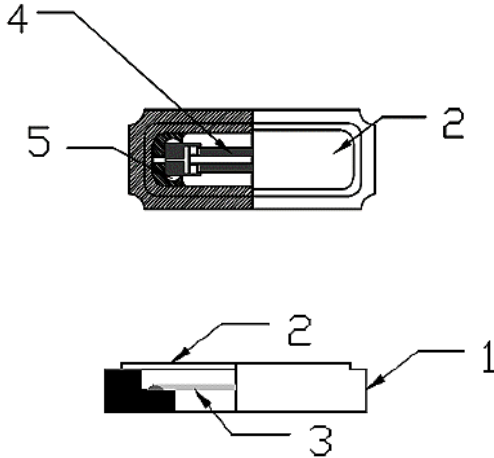

Item No.	Component Name	Material Name
1	Crystal Case	Ceramic (A1203)
2	Crystal Cover/Lid	KV (Fe/Co/Ni)
3	Crystal Chip/Blank	SiO2
4	Electrode	Au, Ag
5	Adhesive	Resin, Ag

EQUIVALENT CIRCUIT

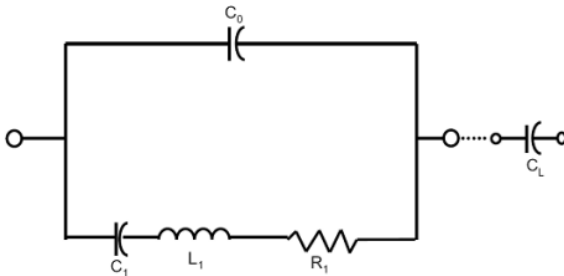

NOTES BEFORE USE

Ultrasonic Cleaning:

General cleaning solutions or ultrasonic cleaning method may be used to clean our products. However, under certain circumstances, ultrasonic cleaning machine could generate resonance at the oscillation frequency of our products and thus deteriorate the electrical characteristics in device and even damage the overall structure of device. Therefore, verification test is recommended before cleaning.

Ultrasonic Welding

Avoid mounting and processing by Ultrasonic welding this method has a possibility of an excessive vibration spreading inside the crystal products and become the cause of characteristic deterioration and not oscillating.

Storage Temperature Description

Storage Temperature is only for the product itself, the temperature for the packing material is 5~40°C

Recommended Conditions for Manual Welding Max. Temperature: 350±10°C, Time: 3 sec Max., Re-solder time: twice Max.

KHZ SMD CRYSTALS CCMM SERIES 2012 TYPE
ELECTRICAL PARAMETERS

Parameter	Part No. Symbol	Units	Value			Condition
			Min.	Typical	Max.	
Original Manufacturer	TGS		TGS Crystals			
Holder Type	CCMS		KHz SMD Crystal L2.0*W1.2*H0.6mm, 2 Pads			
Frequency Range	32K768	KHz	32.76800			
Mode of Oscillation	A		AT Fundamental			
Frequency Tolerance	20	ppm	-20		+20	@25°C
Load Capacitance	-12.5	pF	12.5			
Frequency/Temp Coefficient		ppm/°C ²	-0.02	-	0.04	
Operation Temperance	-40	°C	-40		+85	
Storage Temperance		°C	-55		+125	
Equivalent Series Resistance (ESR)	-90	KΩ			90	
Drive Level		μW		0.1	0.5	
Shunt Capacitance (C0)		pF			7.0	
Dynamic Capacitance (C1)		fF				
Turnover Temp		°C	+20	+25	+30	
Quality Factor		Q	13			
Capacitance Ratio			450			
Aging		ppm/year			±3	@1 st year
Insulation Resistance		MΩ	500			@100Vdc ± 15VDC
Other	Package	T	Tape/Reel, 3000pcs/Reel			
	RoHS Status	LF	RoHS III compliant			
	Add Value		N/A			
	Special Code*		2 letter or digits; Blank: N/A			

 Note: 1) Original Part Number: **TGS CCMS 32K768A20-12.5-40-90T LF**

2) * Internal Control Code- 2 letter or digits; Blank: N/A

11/10/2022

5

KHZ SMD CRYSTALS CCMM SERIES 2012 TYPE
RELIABILITY

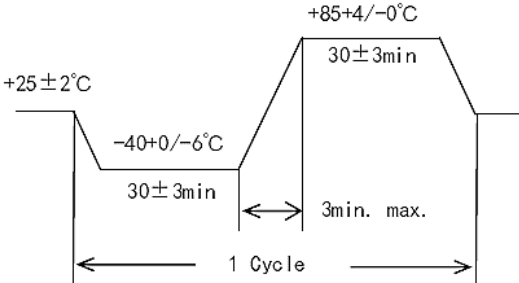
Test Items	Test Method And Conditions	Test Standard
High Temperature High Humidity Storage	Temperature: 60°C ± 2 °C Relative Humidity: 90%~95% RH For Time: 500 ± 12 Hours	A, C, D, G
High Temperature Storage	Temperature: 125°C ± 2°C Time: 1000±12 Hours.	B, C, G
Low Temperature Storage	Temperature: -40°C ± 2°C Time: 500 ± 12 Hours.	A, C, G
Temperature Cycle	<p>The crystal unit shall be subjected to 100 successive change of temperature cycles.</p> 	A, C, G
Solderability	The solder pot temperature is 260±5°C , dwell time 2±0.6sec	F
Drop Test	Height: 180 cm; Dropped Cycle: 3 cycles; Drop it on to a concrete board for 6 Directions (X,Y,Z), that should be 1 cycle	B, C
Vibration	Frequency Range: 10Hz ~ 55Hz Amplitude: 1.5mm±15%; Sweep time: 2~3 Minutes, 2 Hours in each direction, total 6 Hours	A, C
Leakage Test	Helium Bombing 5.0 ~5.5 Kgf/cm ² ; for 2 hours	E

KHZ SMD CRYSTALS CCMM SERIES 2012 TYPE
RELIABILITY

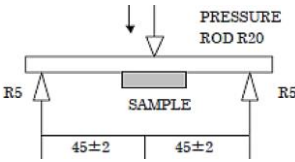
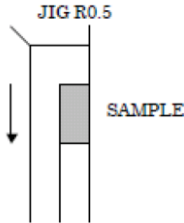
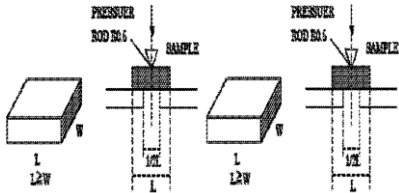
Test Items	Test Method And Conditions	Test Standard
Terminal Strength	Shall be pressurized at a speed of approx. 0.5mm/sec. in the direction indicated by the arrow unit the bending width reaches 3mm and held for 5 sec. 	B, C
Sticking Tendency	A R0.5 Jig shall be used to apply a 10N dead load in the direction indicated by the arrow to the element and retain it for 10 sec. 	B, C
Element Assembly Strength	A R0.5 Jig shall be used to apply a 10N dead load in the direction indicated by the arrow to the element and retain it for 10 sec. 	B, C

TEST STANDARD

Test Standard Symbol	Specification	Value
A	Frequency Change permitted	$\Delta F \leq 10 \text{ppm}$
B	Frequency Change permitted	$\Delta F \leq 20 \text{ppm}$
C	Equivalent Series Resistance Change Permitted	$\Delta C I \leq 5 \text{K}\Omega$ or 20%
D	Insulation Resistance	>500 M Ω
E	Leak Rate Less than	$< 1 \cdot 1 \text{E-}9 \text{ Pa} \cdot \text{m}^3/\text{sec.}$
F	A new uniform coating of solder shall cover a Min 95% of the crystal surface	
G	Then $25 \pm 2^\circ\text{C}$ over 2 hours before Testing	

KHZ SMD CRYSTALS CCMM SERIES 2012 TYPE

SUGGESTED REFLOW PROFILE (For Reference No. JEDEC J-STD-020D)

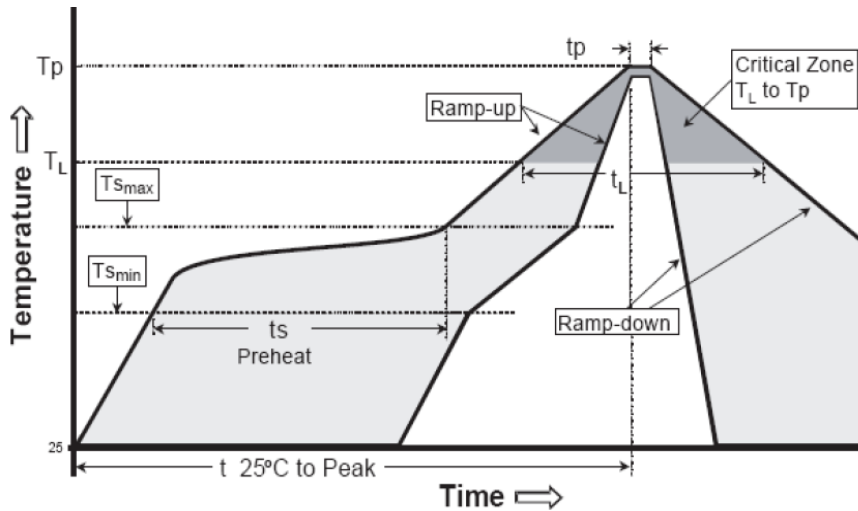

Profile Feature		Pb-Free Assembly
Average Ramp-up Rate (Ts Max to Tp)		3°C/second Max
Preheat	Temperature Min (Ts Min.)	150°C
	Temperature Max (Ts Max.)	200°C
	Time (ts Min. to ts Max.)	60 ~ 120 seconds
Time maintained above	Temperature (TL)	217°C
	Time (tL)	60 ~ 150 seconds
Peak/Classification Temperature (Tp)		260 +/-5°C
Time within 5°C of actual Peak Temperature (tp)		20 ~ 40 seconds
Ramp-down rate		6 °C /Second Max.
Time 25 °C to Peak Temperature		8 minutes Max.
Suggest reflow times		3 Times Max.

KHZ SMD CRYSTALS CCMM SERIES 2012 TYPE

TAPE/REEL (Unit: mm)

All Devices are packed in accordance with EIA standard RS-481-2 and specifications, 3000pcs/Reel

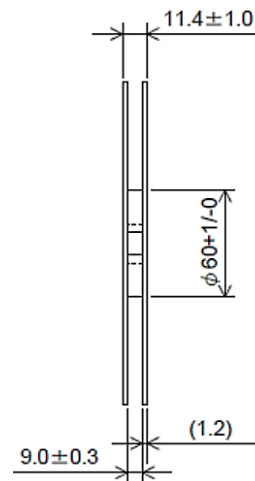
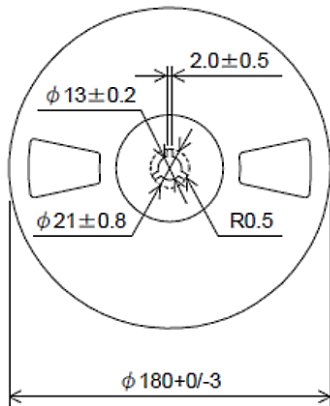
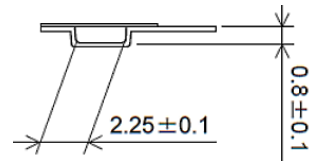
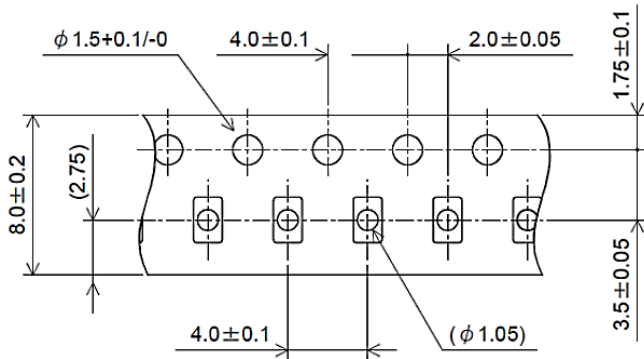

DISCLAIMER

NextGen Components, Inc. reserves the right to make changes to the product(s) and or information contained herein without notice. No liability is assumed as a result of their use or application. No rights under any patent accompany the sale of any such product(s) or information.