



KT5G-2N1114
KT5

CONTRAST SENSORS

SICK
Sensor Intelligence.



Ordering information

| Type | Part no. |
|-------------|----------|
| KT5G-2N1114 | 1017000 |

Other models and accessories → www.sick.com/KT5



Detailed technical data

Features

| | |
|--|--|
| Dimensions (W x H x D) | 30.4 mm x 53 mm x 80 mm |
| Sensing distance | 10 mm ¹⁾ |
| Sensing distance tolerance | ± 3 mm |
| Housing design (light emission) | Rectangular |
| Light source | LED, green ²⁾ |
| Wave length | 520 nm |
| Light emission | Long and short side of housing, exchangeable |
| Light spot size | 1.2 mm x 4.2 mm |
| Light spot direction | Vertical ³⁾ |
| Adjustment | None |
| Teach-in mode | Automatic contrast detection |

¹⁾ From front edge of lens.

²⁾ Average service life: 100,000 h at T_J = +25 °C.

³⁾ In relation to long side of housing.

Mechanics/electronics

| | |
|----------------------------|-----------------------------------|
| Supply voltage | 10 V DC ... 30 V DC ¹⁾ |
| Ripple | ≤ 5 V _{pp} ²⁾ |
| Power consumption | < 80 mA ³⁾ |
| Switching frequency | 10 kHz ⁴⁾ |

¹⁾ Limit values when operated in short-circuit protected network: max. 8 A.

²⁾ May not exceed or fall below U_v tolerances.

³⁾ Without load.

⁴⁾ With light/dark ratio 1:1.

⁵⁾ Signal transit time with resistive load.

⁶⁾ Short-circuit-proof.

⁷⁾ Reference voltage DC 50 V.

| | |
|---------------------------------------|--|
| Response time | 50 μ s ⁵⁾ |
| Switching output | NPN |
| Output current I_{max} | 100 mA ⁶⁾ |
| Input, fine/coarse (F/C) | NPN: fine: U = U _v Coarse: U = 0 V |
| Input, light/dark (L/D) | NPN: light: U = U _v Dark: U = 0 V |
| Retention time (ET) | 25 ms, non-volatile memory |
| Connection type | Male connector M12, 5-pin |
| Protection class | II ⁷⁾ |
| Circuit protection | U _v connections, reverse polarity protected Output Q short-circuit protected Interference pulse suppression |
| Enclosure rating | IP67 |
| Weight | 400 g |
| Housing material | Metal, Zinc diecast |

- 1) Limit values when operated in short-circuit protected network: max. 8 A.
- 2) May not exceed or fall below U_v tolerances.
- 3) Without load.
- 4) With light/dark ratio 1:1.
- 5) Signal transit time with resistive load.
- 6) Short-circuit-proof.
- 7) Reference voltage DC 50 V.

Ambient data

| | |
|--------------------------------------|------------------------------|
| Ambient operating temperature | -10 °C ... +55 °C |
| Ambient storage temperature | -25 °C ... +75 °C |
| Shock load | According to IEC 60068 |
| UL File No. | NRKH.E181493 & NRKH7.E181493 |

Classifications

| | |
|-----------------------|----------|
| ECl@ss 5.0 | 27270906 |
| ECl@ss 5.1.4 | 27270906 |
| ECl@ss 6.0 | 27270906 |
| ECl@ss 6.2 | 27270906 |
| ECl@ss 7.0 | 27270906 |
| ECl@ss 8.0 | 27270906 |
| ECl@ss 8.1 | 27270906 |
| ECl@ss 9.0 | 27270906 |
| ETIM 5.0 | EC001820 |
| ETIM 6.0 | EC001820 |
| UNSPSC 16.0901 | 39121528 |

Dimensional drawing (Dimensions in mm (inch))

KT5-2 Teach-in, KT5-2 Display

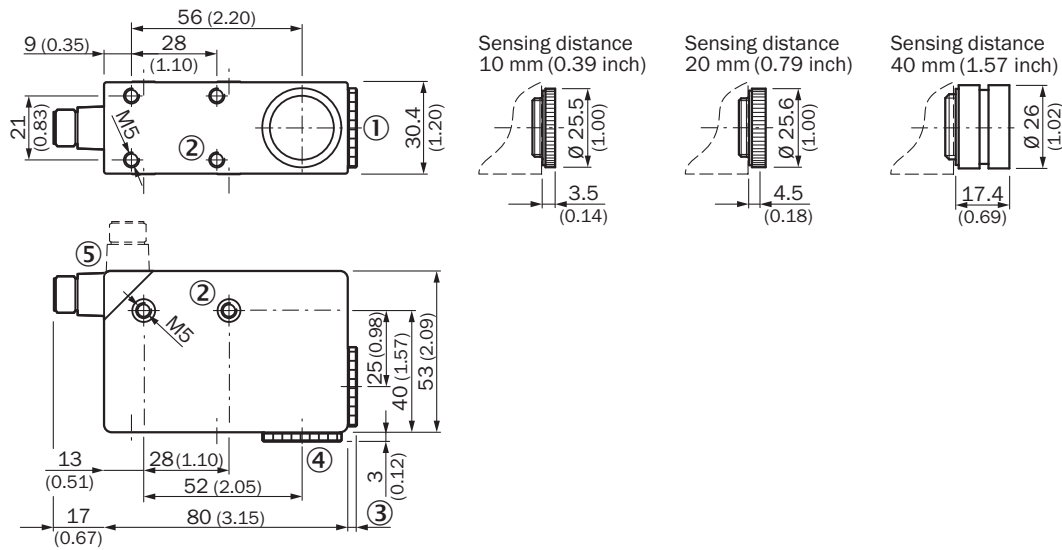

- ① Lens (light transmission), can be exchanged for pos. 4
- ② M5 threaded mounting hole, 5.5 mm deep
- ③ See dimensional drawings of lenses
- ④ Blind screw can be replaced by pos. 1
- ⑤ Connector M12 (rotatable up to 90°)

Adjustments

KT5-2 Teach-in, KT5G-xxx4

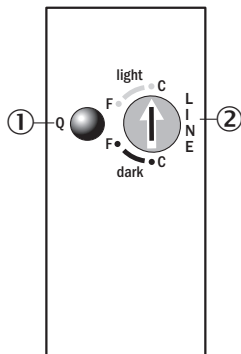

- ① Function signal indicator (yellow)
- ② Fine/coarse switch

Connection diagram

Cd-325

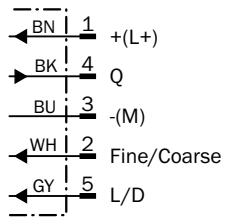

Characteristic curve

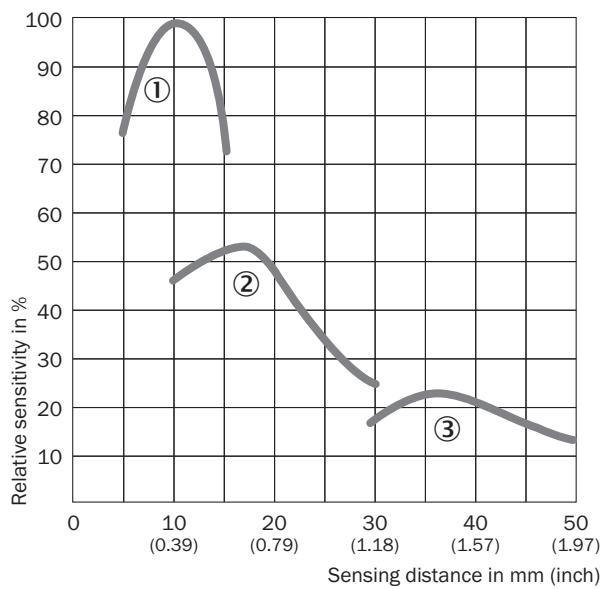

KT5-2 Teach-in, KT5G, KT5W, KT5-2 Display







- ① Sensing distance 10 mm
- ② Sensing distance 20 mm
- ③ Sensing distance 40 mm

Recommended accessories

Other models and accessories → www.sick.com/KT5

| | Brief description | Type | Part no. |
|---|---|-------------|----------|
| Universal bar clamp systems | | | |
|  | Plate G for universal clamp bracket, steel, zinc coated, Universal clamp (2022726), mounting hardware | BEF-KHS-G01 | 2022464 |
|  | Plate K for universal clamp bracket, steel, zinc coated, Universal clamp (2022726), mounting hardware | BEF-KHS-K01 | 2022718 |

| | Brief description | Type | Part no. |
|---|--|--------------------|----------|
|  | Universal clamp bracket for rod mounting, steel, zinc coated, without mounting hardware | BEF-KHS-KH1 | 2022726 |
|  | Mounting bar, straight, 200 mm, steel, steel, zinc coated, without mounting hardware | BEF-MS12G-A | 4056054 |
| | Mounting bar, straight, 300 mm, steel, steel, zinc coated, without mounting hardware | BEF-MS12G-B | 4056055 |
| | Mounting bar, L-shaped, 150 mm x 150 mm, steel, steel, zinc coated, without mounting hardware | BEF-MS12L-A | 4056052 |
| | Mounting bar, L-shaped, 250 x 250 mm, steel, steel, zinc coated, without mounting hardware | BEF-MS12L-B | 4056053 |
| Plug connectors and cables | | | |
|  | Head A: female connector, M12, 5-pin, straight, A-coded Head B: Flying leads Cable: Sensor/actuator cable, PVC, unshielded, 2 m | YF2A15-020VB5XLEAX | 2096239 |
| | Head A: female connector, M12, 5-pin, straight, A-coded Head B: Flying leads Cable: Sensor/actuator cable, PVC, unshielded, 5 m | YF2A15-050VB5XLEAX | 2096240 |
| | Head A: female connector, M12, 5-pin, straight, A-coded Head B: Flying leads Cable: Sensor/actuator cable, PVC, unshielded, 10 m | YF2A15-100VB5XLEAX | 2096241 |
|  | Head A: female connector, M12, 5-pin, angled, A-coded Head B: Flying leads Cable: Sensor/actuator cable, PVC, unshielded, 2 m | YG2A15-020VB5XLEAX | 2096215 |
| | Head A: female connector, M12, 5-pin, angled, A-coded Head B: Flying leads Cable: Sensor/actuator cable, PVC, unshielded, 5 m | YG2A15-050VB5XLEAX | 2096216 |
| | Head A: female connector, M12, 5-pin, angled, A-coded Head B: Flying leads Cable: Sensor/actuator cable, PVC, unshielded, 10 m | YG2A15-100VB5XLEAX | 2096217 |
|  | Head A: female connector, M12, 5-pin, straight Cable: unshielded | DOS-1205-G | 6009719 |
|  | Head A: female connector, M12, 5-pin, angled Head B: - Cable: unshielded | DOS-1205-W | 6009720 |
| Lenses and accessories | | | |
| | Lens, 40 mm sensing distance, M20 x 0.75 | OBJ-210 | 2010945 |
| | Lens, 10 mm sensing distance, M20 x 0.75 | OBJ-211 | 1004936 |
| | Lens, 20 mm sensing distance, M20 x 0.75 | OBJ-212 | 1011506 |

SICK AT A GLANCE

SICK is one of the leading manufacturers of intelligent sensors and sensor solutions for industrial applications. A unique range of products and services creates the perfect basis for controlling processes securely and efficiently, protecting individuals from accidents and preventing damage to the environment.

We have extensive experience in a wide range of industries and understand their processes and requirements. With intelligent sensors, we can deliver exactly what our customers need. In application centers in Europe, Asia and North America, system solutions are tested and optimized in accordance with customer specifications. All this makes us a reliable supplier and development partner.

Comprehensive services complete our offering: SICK LifeTime Services provide support throughout the machine life cycle and ensure safety and productivity.

For us, that is “Sensor Intelligence.”

WORLDWIDE PRESENCE:

Contacts and other locations –www.sick.com