

PXF40-xxDxx Dual Output DC/DC Converter

9 to 18 Vdc and 18 to 36 Vdc and 36 to 75 Vdc input, 3.3 to 15 Vdc Dual Output, 40W



APPLICATIONS

Wireless Network
Telecom/Datacom
Industry Control System
Measurement
Semiconductor Equipment

Features

- Dual output current up to 8A
- 40 watts maximum output power
- 2:1 wide input voltage range
- Six-sided continuous shield
- High efficiency up to 89%
- Low profile: 2.00 x 2.00 x 0.40 inch (50.8 x 50.8 x 10.2 mm)
- Fixed switching frequency
- RoHS directive compliant
- Input to output isolation: 1600Vdc,min
- Over-temperature protection
- Input under-voltage protection
- Output over-voltage protection
- Over-current protection, auto-recovery
- Output short circuit protection, auto-recovery
- Remote ON/OFF

Options

- Heat sinks available for extended operation

General Description

The PXF40-xxDxx series offers 40 watts of output power from a 2 x 2 x 0.4 inch package. This series has a 2:1 wide input voltage of 9-18VDC, 18-36VDC or 36-75VDC and features 1600VDC of isolation, short-circuit and over-voltage protection.

Table of Contents

Absolute Maximum Rating	P2	Thermal Consideration	P27
Output Specification	P2	Heat Sink Consideration	P28
Input Specification	P3	Remote ON/OFF Control	P29
General Specification	P4	Mechanical Data	P30
Characteristic Curves	P5	Recommended Pad Layout	P31
Testing Configurations	P23	Output Voltage Adjustment	P32
EMC Considerations	P24	Soldering and Reflow Consideration	P33
Input Source Impedance	P26	Packaging Information	P34
Output Over Current Protection	P26	Part Number Structure	P34
Output Over Voltage Protection	P27	Safety and Installation Instruction	P35
Short Circuit Protection	P27	MTBF and Reliability	P35

Absolute Maximum Rating					
Parameter	Model	Min	Max	Unit	
Input Voltage	Continuous	12Dxx		18	Vdc
		24Dxx		36	
		48Dxx		75	
	Transient (100ms)	12Dxx		36	
		24Dxx		50	
		48Dxx		100	
Operating Ambient Temperature (with derating)	All	-40	85	°C	
Operating Case Temperature	All		100	°C	
Storage Temperature	All	-55	105	°C	

Output Specification					
Parameter	Model	Min	Typ	Max	Unit
Output Voltage ($V_{in} = V_{in(nom)}$; Full Load ; $T_A=25^\circ\text{C}$)	xxD12	11.88	12	12.12	Vdc
	xxD15	14.85	15	15.15	
	xxD3305	3.267/4.95	3.3/5	3.333/5.05	
Voltage Adjustability	All	-10		+10	%
Output Regulation Line ($V_{in(min)}$ to $V_{in(max)}$ at Full Load) Load (Min. to 100% of Full Load)	All	-0.5		+0.5	%
		-1.0		+1.0	
Output Ripple & Noise Peak-to-Peak (20MHz bandwidth) (Measured with a 0.1 μF /50V MLCC)	xxD12		120		mVp-p
	xxD15		150		
	xxD3305		100		
Temperature Coefficient	All	-0.02		+0.02	%/°C
Output Voltage Overshoot ($V_{in(min)}$ to $V_{in(max)}$; Full Load ; $T_A=25^\circ\text{C}$)	All		0	3	% V_b
Dynamic Load Response ($V_{in} = V_{in(nom)}$; $T_A=25^\circ\text{C}$) Load step change from 75% to 100% or 100 to 75% of Full Load Peak Deviation	All		250		mV
	All		250		μS
Output Current (Any condition of dual output (3.3V/5V) rated lout current, not to exceed 8A of total output currents. The product safety approval pending)	xxD12	± 144		± 1800	mA A
	xxD15	± 112		± 1400	
	xxD3305	0		4/4	
Output Over Voltage Protection (Zener diode clamp)	xxD12		15		Vdc
	xxD15		18		
	xxD3305		3.9/6.2		
Output Over Current Protection	All			150	% FL
Output Short Circuit Protection	All	Hiccup, automatic recovery			

Input Specification					
Parameter	Model	Min	Typ	Max	Unit
Operating Input Voltage	12Dxx	9	12	18	Vdc
	24Dxx	18	24	36	
	48Dxx	36	48	75	
Input Current (Maximum value at $V_{in} = V_{in(nom)}$; Full Load)	12D12			4444	mA
	12D15			4321	
	12D3305			3416	
	24D12			2169	
	24D15			2108	
	24D3305			1689	
	48D12			1084	
	48D15			1054	
Input Standby Current (Typical value at $V_{in} = V_{in(nom)}$; No Load)	12D12		30		mA
	12D15		35		
	12D3305		325		
	24D12		20		
	24D15		20		
	24D3305		80		
	48D12		15		
	48D15		15		
Under Voltage Lockout Turn-on Threshold	12Dxx			9	Vdc
	24Dxx			17.8	
	48Dxx			36	
Under Voltage Lockout Turn-off Threshold	12Dxx		8		Vdc
	24Dxx		16		
	48Dxx		34		
Input Reflected Ripple Current (5 to 20MHz, 12 μ H Source Impedance)	All		40		mAp-p
Start Up Time ($V_{in} = V_{in(nom)}$ and Constant Resistive Load)					mS
	Power Up	All		25	
Remote ON/OFF				25	
Remote ON/OFF Control (The ON/OFF pin voltage is referenced to $-V_{IN}$)					Vdc
	Positive Logic DC-DC ON	All	3.5	12	
DC-DC OFF		0		1.2	
Remote Off Input Current	All		2.5		mA
Input Current of Remote Control Pin	All	-0.5		0.5	mA

General Specification					
Parameter	Model	Min	Typ	Max	Unit
Efficiency ($V_{in} = V_{in(nom)}$; Full Load ; $T_A=25^{\circ}C$)	12D12		85		%
	12D15		85		
	12D3305		85		
	24D12		87		
	24D15		87		
	24D3305		86		
	48D12		87		
	48D15		87		
	48D3305		88		
Isolation Voltage Input to Output Input to Case, Output to Case	All	1600 1600			Vdc
Isolation Resistance	All	1			GΩ
Isolation Capacitance	All			1000	pF
Switching Frequency master (5Vo) 300kHz slave (3.3Vo) 500kHz	xxD12 xxD15 xxD3305		300		kHz
Weight	All		60		g
MTBF Belcore TR-NWT-000332, $T_C=40^{\circ}C$ MIL-HDBK-217F	All		1.398×10 ⁶ 3.585×10 ⁶		hours
Over Temperature Protection	All		115		°C

Characteristic Curves

All test conditions are at 25°C. The figures are for PXF40-12D12

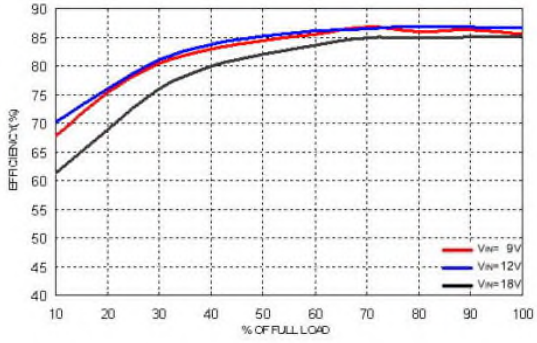

Efficiency Versus Output Current

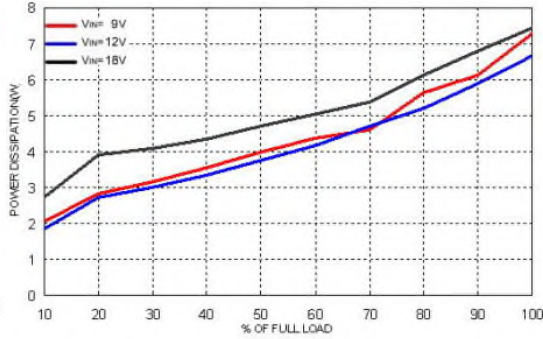

Power Dissipation Versus Output Current

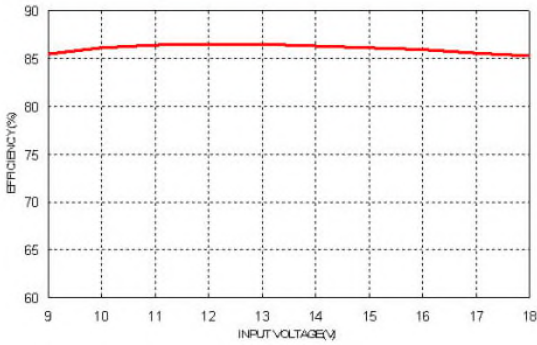

Efficiency Versus Input Voltage. Full Load

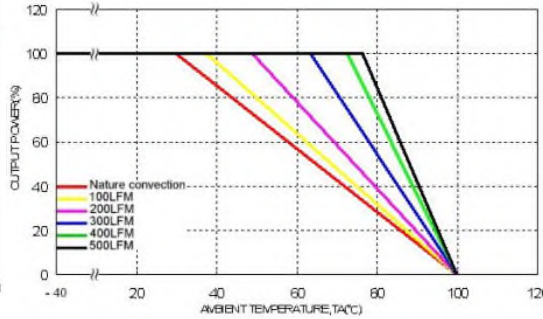

Derating Output Current Versus Ambient Temperature and Airflow $V_{in} = V_{in(nom)}$

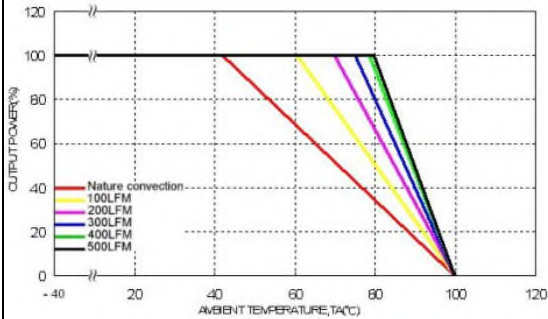

Derating Output Current Versus Ambient Temperature with Heat-Sink and Airflow, $V_{in} = V_{in(nom)}$

Characteristic Curves (Continued)

All test conditions are at 25°C. The figures are for PXF40-12D12

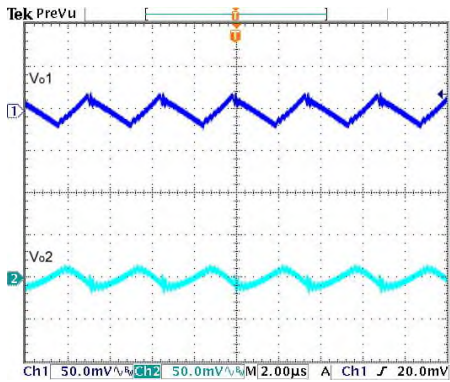

Typical Output Ripple and Noise.
 $V_{in} = V_{in(nom)}$, Full Load

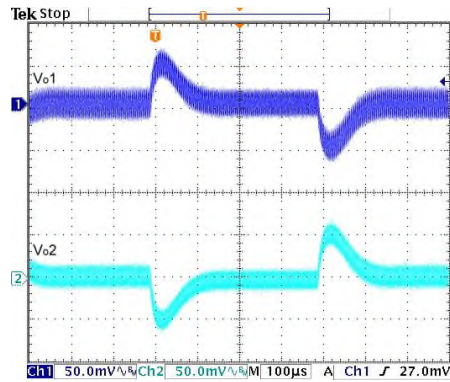

Transient Response to Dynamic Load Change from
 100% to 75% to 100% of Full Load ; $V_{in} = V_{in(nom)}$

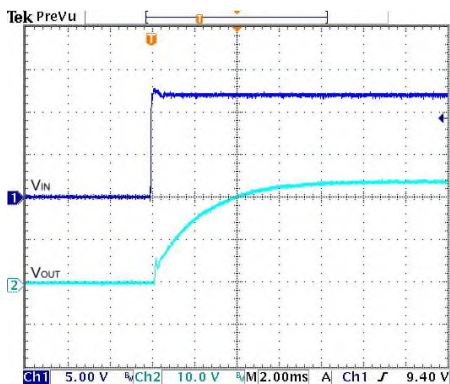

Typical Input Start-Up and Output Rise Characteristic
 $V_{in} = V_{in(nom)}$, Full Load

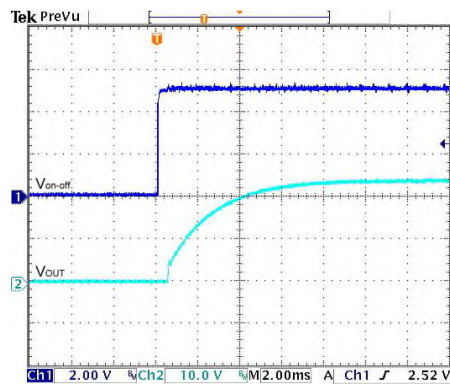

Using ON/OFF Voltage Start-Up and V_o Rise Characteristic
 $V_{in} = V_{in(nom)}$, Full Load

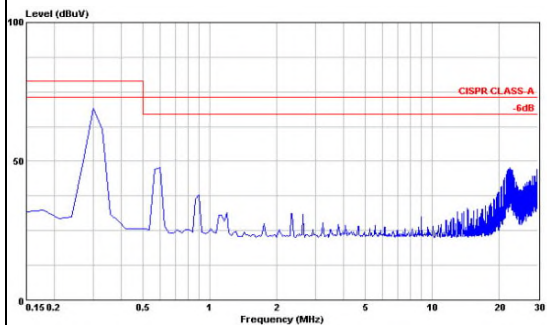

Conduction Emission of EN55022 Class A
 $V_{in} = V_{in(nom)}$, Full Load

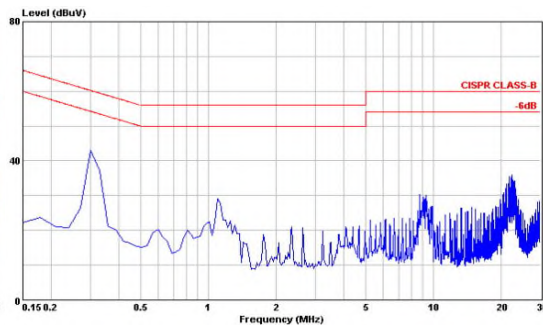

Conduction Emission of EN55022 Class B
 $V_{in} = V_{in(nom)}$, Full Load

Characteristic Curves (Continued)

All test conditions are at 25°C. The figures are for PXF40-12D15

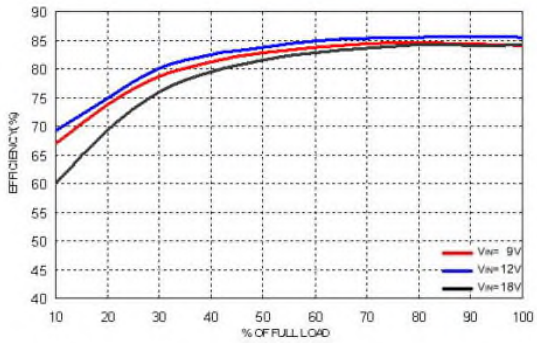

Efficiency Versus Output Current

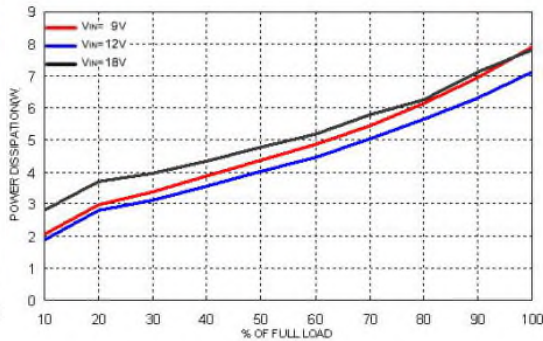

Power Dissipation Versus Output Current

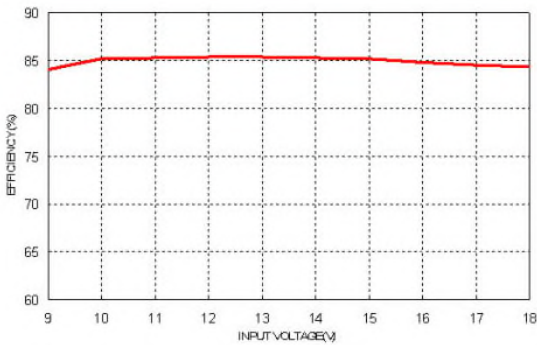

Efficiency Versus Input Voltage. Full Load

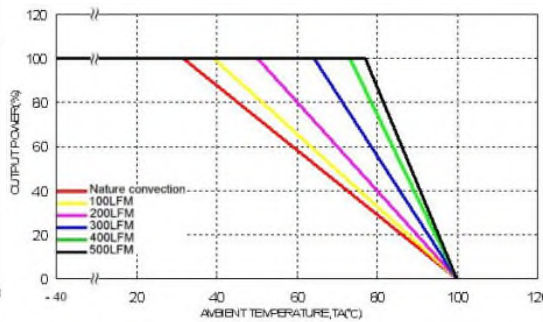

Derating Output Current Versus Ambient Temperature and Airflow Vin = Vin(nom)

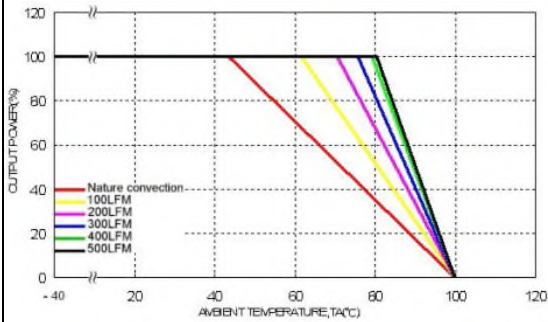

Derating Output Current Versus Ambient Temperature with Heat-Sink and Airflow, Vin = Vin(nom)

Characteristic Curves (Continued)

All test conditions are at 25°C. The figures are for PXF40-12D15

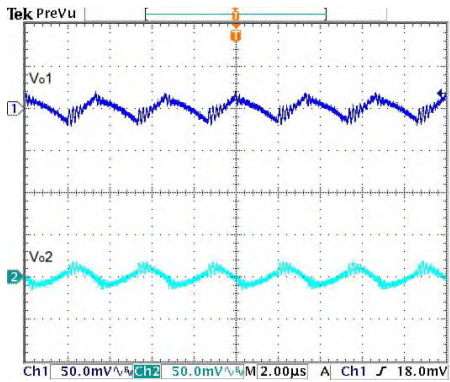

Typical Output Ripple and Noise.
 $V_{in} = V_{in(nom)}$, Full Load

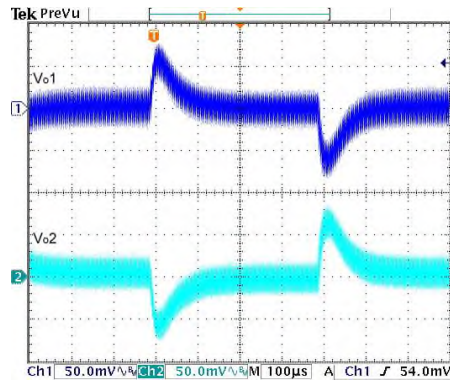

Transient Response to Dynamic Load Change from
 100% to 75% to 100% of Full Load ; $V_{in} = V_{in(nom)}$

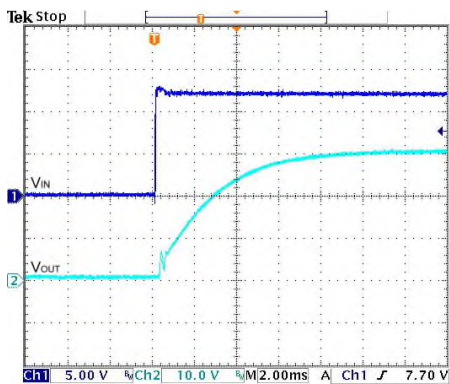

Typical Input Start-Up and Output Rise Characteristic
 $V_{in} = V_{in(nom)}$, Full Load

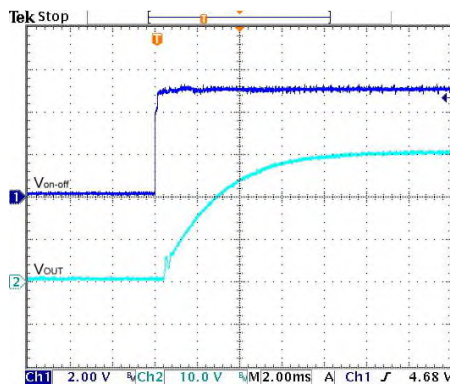

Using ON/OFF Voltage Start-Up and Vo Rise Characteristic
 $V_{in} = V_{in(nom)}$, Full Load

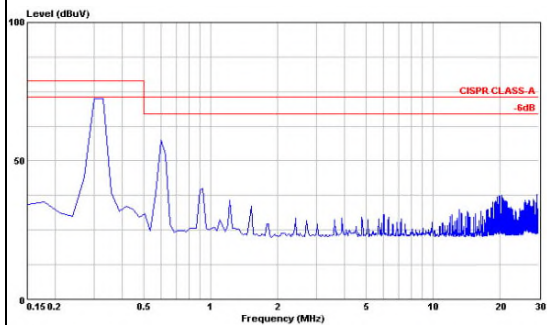

Conduction Emission of EN55022 Class A
 $V_{in} = V_{in(nom)}$, Full Load

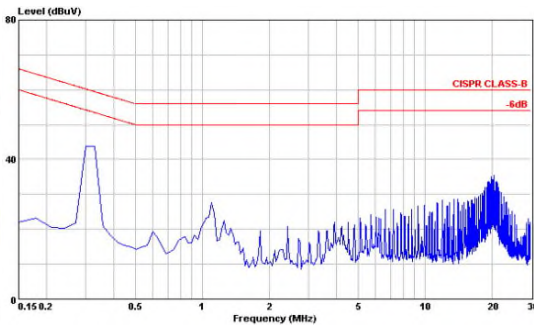

Conduction Emission of EN55022 Class B
 $V_{in} = V_{in(nom)}$, Full Load

Characteristic Curves (Continued)

All test conditions are at 25°C. The figures are for PXF40-12D3305

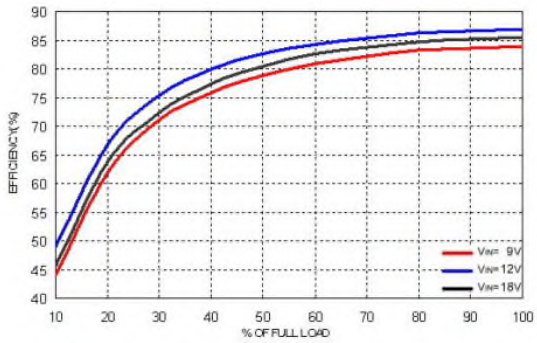

Efficiency Versus Output Current

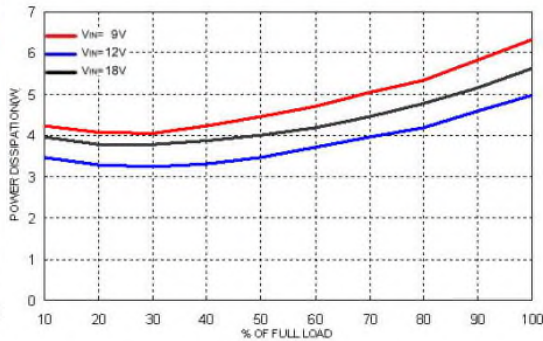

Power Dissipation Versus Output Current

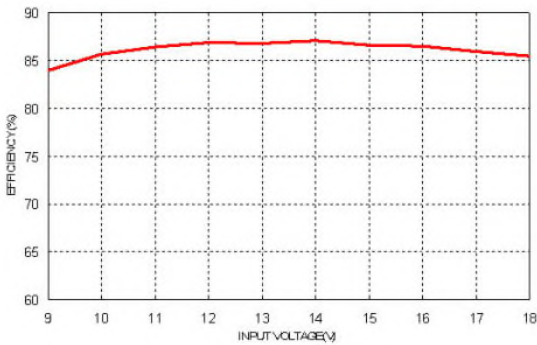

Efficiency Versus Input Voltage. Full Load

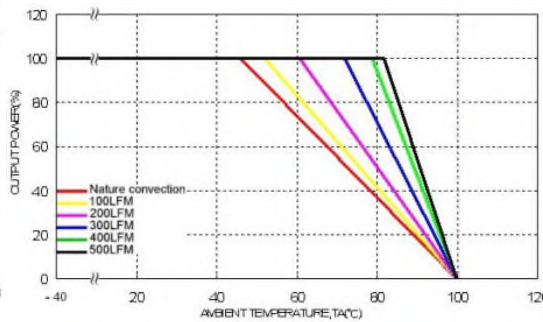

Derating Output Current Versus Ambient Temperature and Airflow
 $V_{in} = V_{in}(nom)$

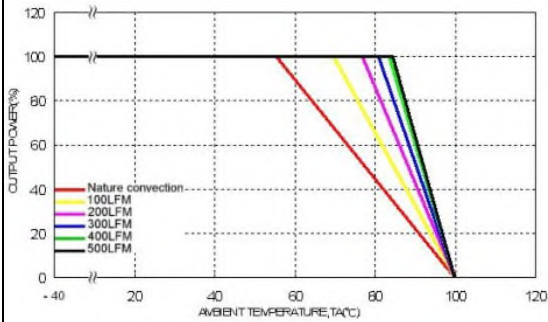

Derating Output Current Versus Ambient Temperature with Heat-Sink
and Airflow, $V_{in} = V_{in}(nom)$

Characteristic Curves (Continued)

All test conditions are at 25°C. The figures are for PXF40-12D3305

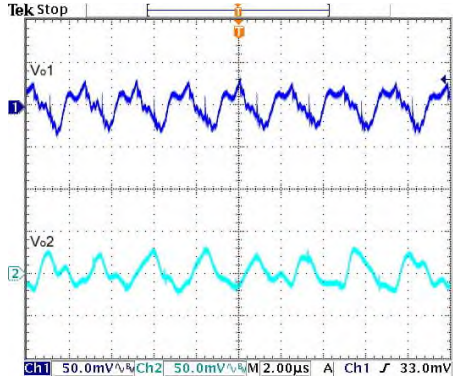

Typical Output Ripple and Noise.
 $V_{in} = V_{in(nom)}$, Full Load

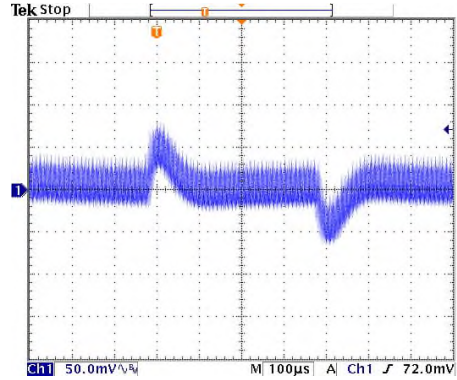

+5Vo:
 Transient Response to Dynamic Load Change from 100% to 75% to 100% of Full Load ; $V_{in} = V_{in(nom)}$
 +3.3Vo: Full load

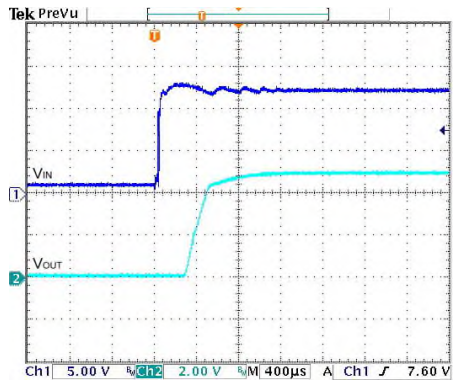

Typical Input Start-Up and Output Rise Characteristic
 $V_{in} = V_{in(nom)}$, Full Load

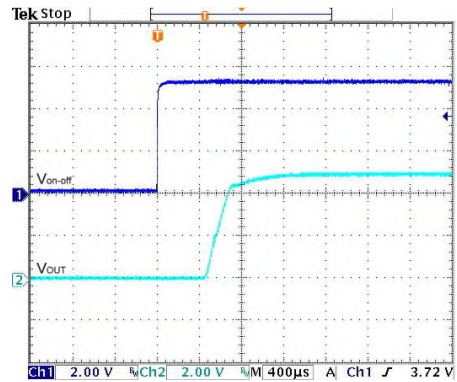

Using ON/OFF Voltage Start-Up and Vo Rise Characteristic
 $V_{in} = V_{in(nom)}$, Full Load

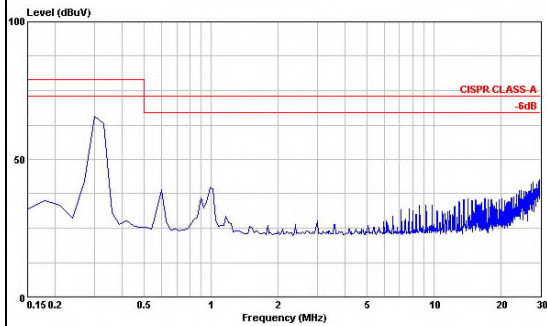

Conduction Emission of EN55022 Class A
 $V_{in} = V_{in(nom)}$, Full Load

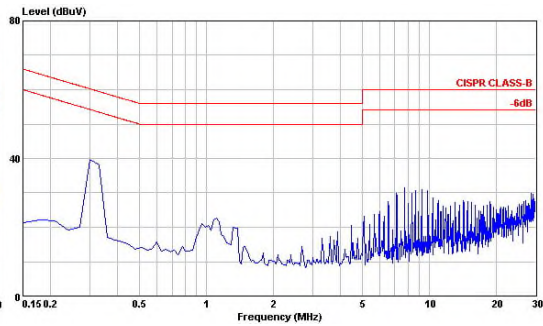

Conduction Emission of EN55022 Class B
 $V_{in} = V_{in(nom)}$, Full Load

Characteristic Curves (Continued)

All test conditions are at 25°C. The figures are for PXF40-24D12

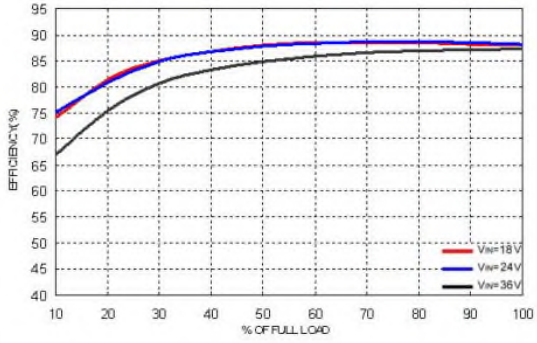

Efficiency Versus Output Current

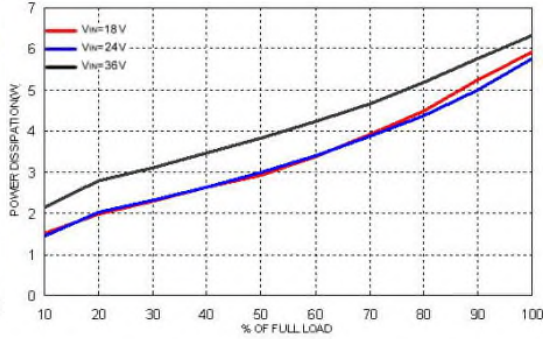

Power Dissipation Versus Output Current

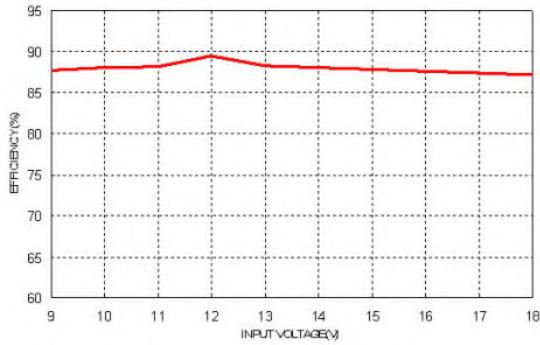

Efficiency Versus Input Voltage. Full Load

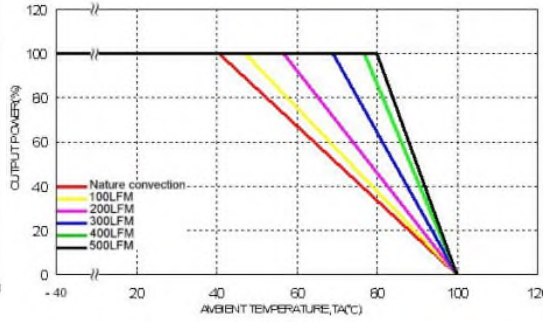

Derating Output Current Versus Ambient Temperature and Airflow Vin = Vin(nom)

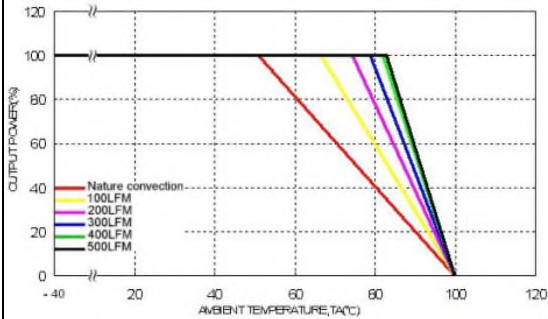

Derating Output Current Versus Ambient Temperature with Heat-Sink and Airflow, Vin = Vin(nom)

Characteristic Curves (Continued)

All test conditions are at 25°C. The figures are for PXF40-24D12

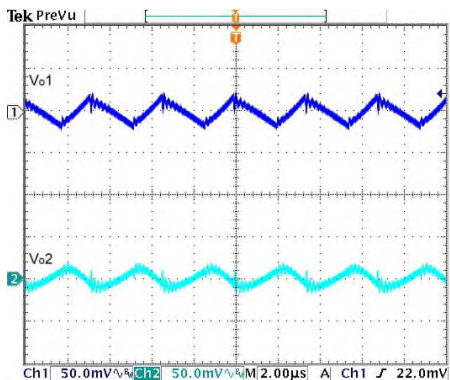

Typical Output Ripple and Noise.
 $V_{in} = V_{in(nom)}$, Full Load

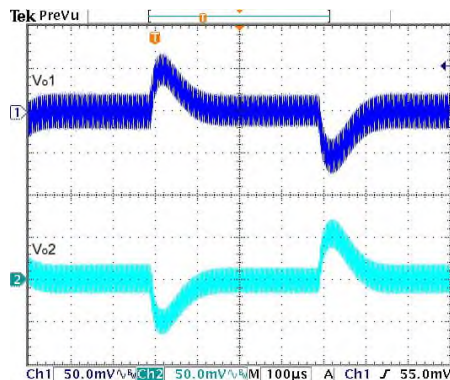

Transient Response to Dynamic Load Change from
 100% to 75% to 100% of Full Load ; $V_{in} = V_{in(nom)}$

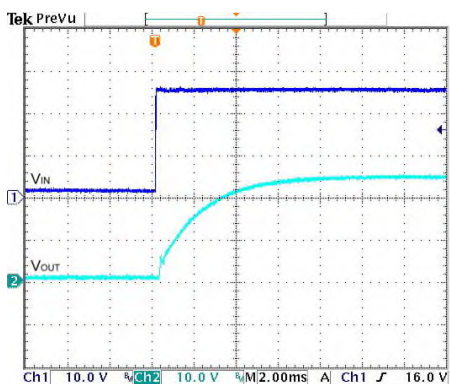

Typical Input Start-Up and Output Rise Characteristic
 $V_{in} = V_{in(nom)}$, Full Load

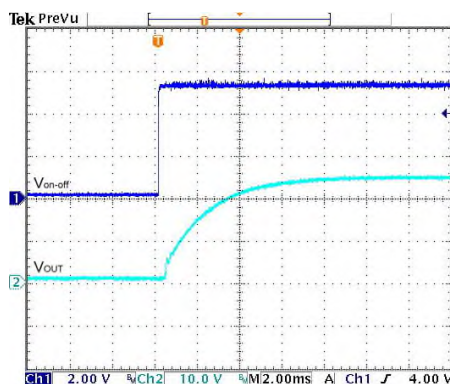

Using ON/OFF Voltage Start-Up and V_o Rise Characteristic
 $V_{in} = V_{in(nom)}$, Full Load

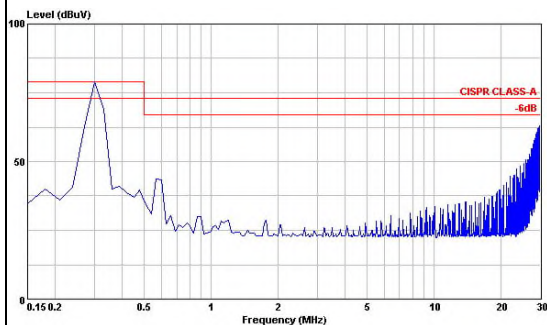

Conduction Emission of EN55022 Class A
 $V_{in} = V_{in(nom)}$, Full Load

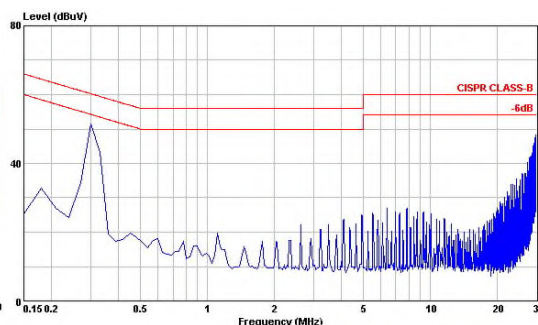

Conduction Emission of EN55022 Class B
 $V_{in} = V_{in(nom)}$, Full Load

Characteristic Curves (Continued)

All test conditions are at 25°C. The figures are for PXF40-24D15

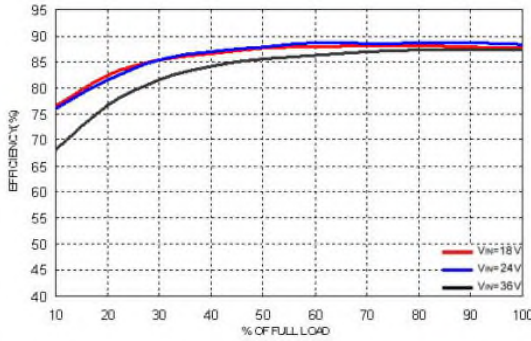

Efficiency Versus Output Current

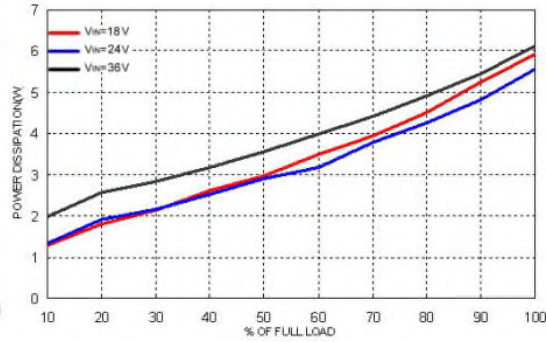

Power Dissipation Versus Output Current

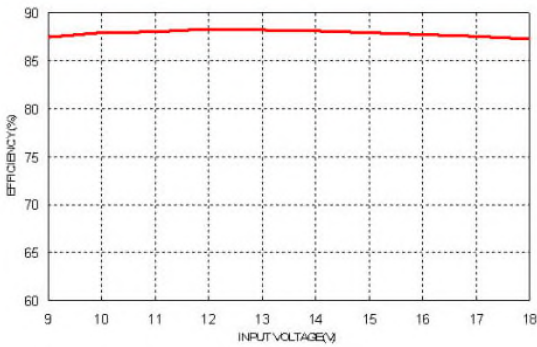

Efficiency Versus Input Voltage, Full Load

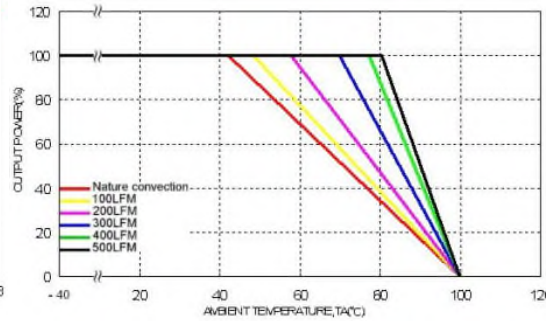

Derating Output Current Versus Ambient Temperature and Airflow Vin = Vin(nom)

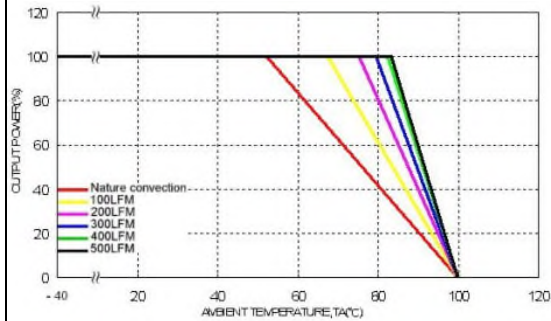

Derating Output Current Versus Ambient Temperature with Heat-Sink and Airflow, Vin = Vin(nom)

Characteristic Curves (Continued)

All test conditions are at 25°C. The figures are for PXF40-24D15

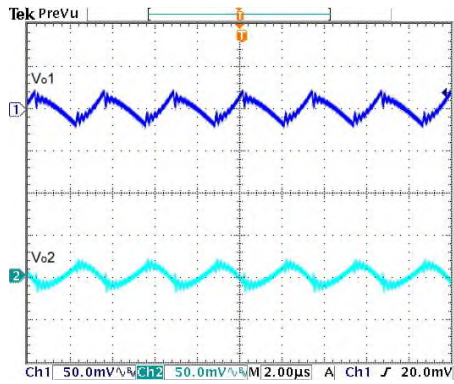

Typical Output Ripple and Noise.
 $V_{in} = V_{in(nom)}$, Full Load

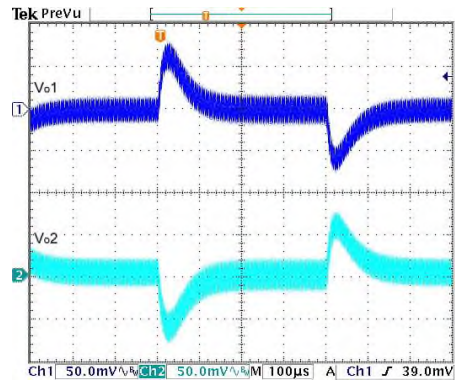

Transient Response to Dynamic Load Change from
 100% to 75% to 100% of Full Load ; $V_{in} = V_{in(nom)}$

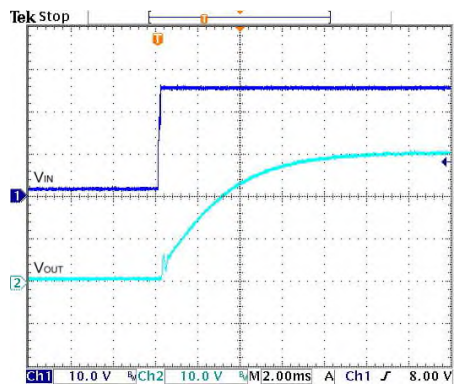

Typical Input Start-Up and Output Rise Characteristic
 $V_{in} = V_{in(nom)}$, Full Load

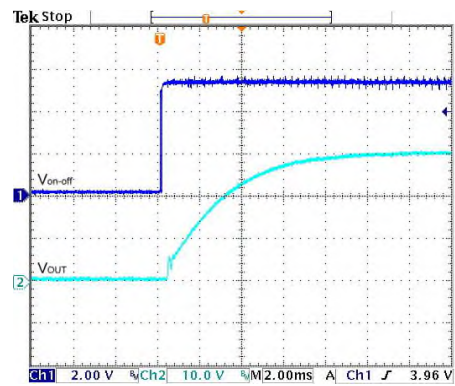

Using ON/OFF Voltage Start-Up and V_o Rise Characteristic
 $V_{in} = V_{in(nom)}$, Full Load

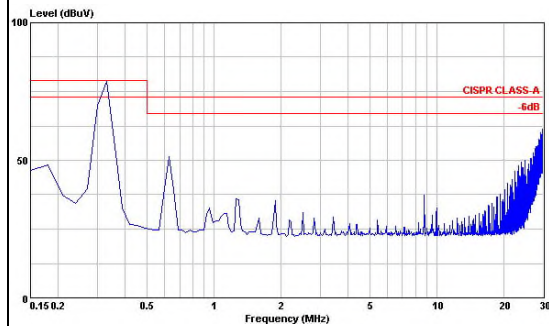

Conduction Emission of EN55022 Class A
 $V_{in} = V_{in(nom)}$, Full Load

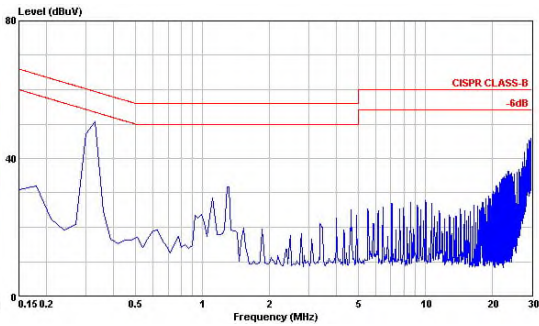

Conduction Emission of EN55022 Class B
 $V_{in} = V_{in(nom)}$, Full Load

Characteristic Curves (Continued)

All test conditions are at 25°C. The figures are for PXF40-24D3305

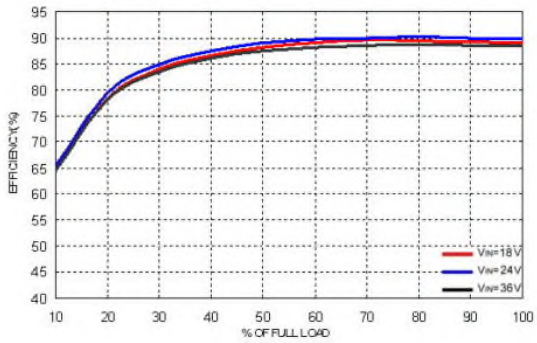

Efficiency Versus Output Current

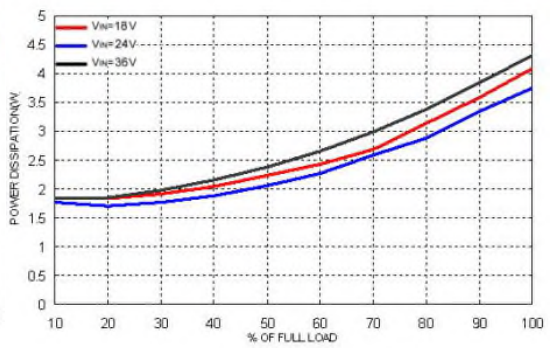

Power Dissipation Versus Output Current

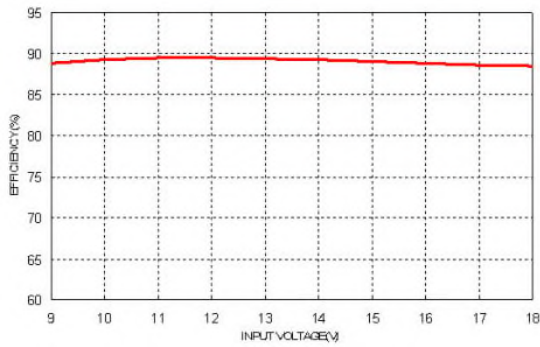

Efficiency Versus Input Voltage. Full Load

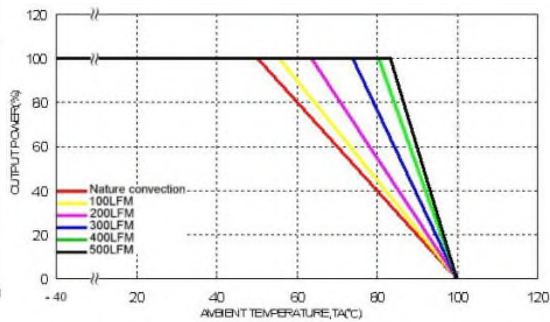

Derating Output Current Versus Ambient Temperature and Airflow
V_{in} = V_{in}(nom)

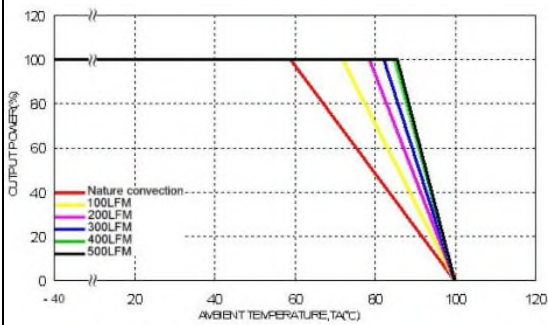

Derating Output Current Versus Ambient Temperature with Heat-Sink
and Airflow, V_{in} = V_{in}(nom)

Characteristic Curves (Continued)

All test conditions are at 25°C. The figures are for PXF40-24D3305

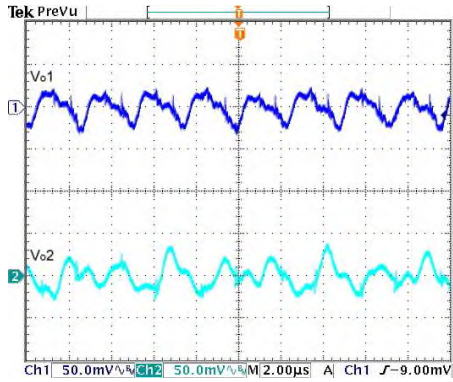

Typical Output Ripple and Noise.
 $V_{in} = V_{in(nom)}$, Full Load

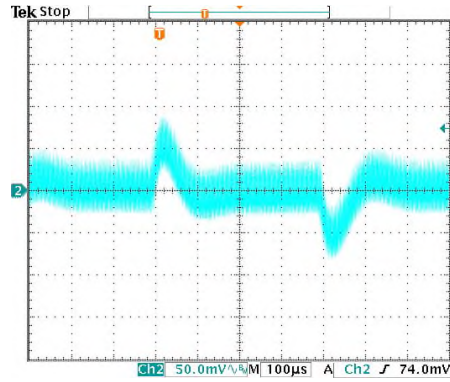

+5Vo: Transient Response to Dynamic Load Change from 100% to 75% to 100% of Full Load ; $V_{in} = V_{in(nom)}$
 +3.3Vo: Full load

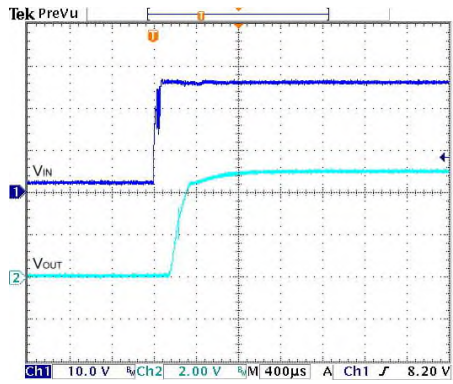

Typical Input Start-Up and Output Rise Characteristic
 $V_{in} = V_{in(nom)}$, Full Load

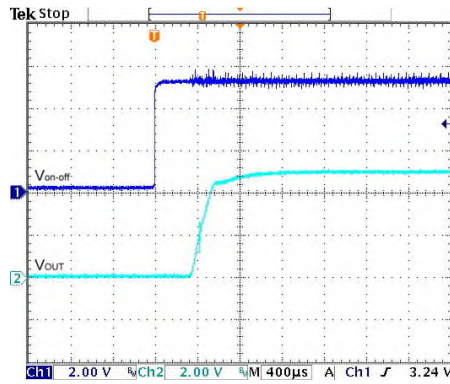

Using ON/OFF Voltage Start-Up and Vo Rise Characteristic
 $V_{in} = V_{in(nom)}$, Full Load

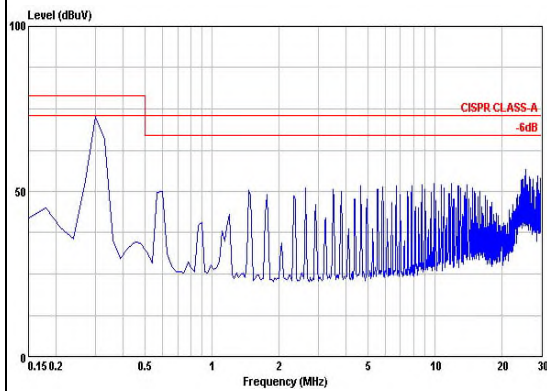

Conduction Emission of EN55022 Class A
 $V_{in} = V_{in(nom)}$, Full Load

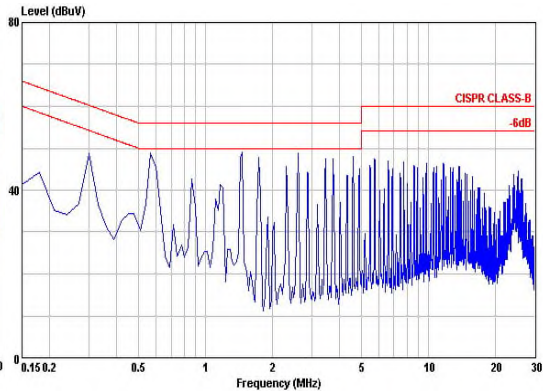

Conduction Emission of EN55022 Class B
 $V_{in} = V_{in(nom)}$, Full Load

Characteristic Curves (Continued)

All test conditions are at 25°C. The figures are for PXF40-48D12

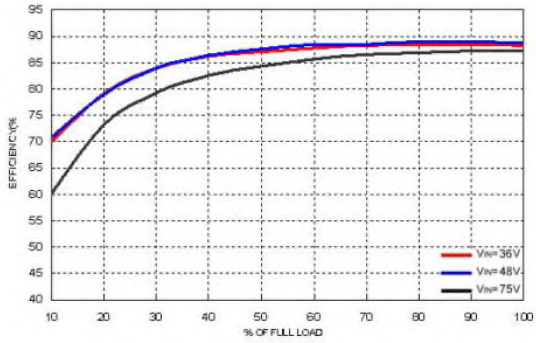

Efficiency Versus Output Current

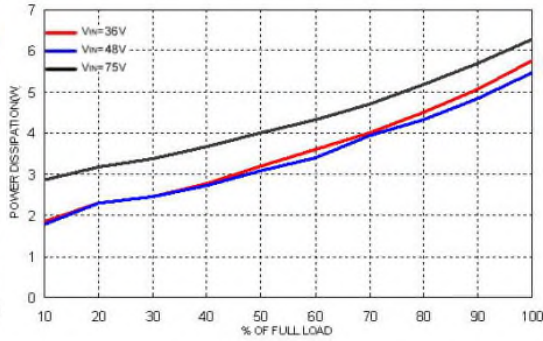

Power Dissipation Versus Output Current

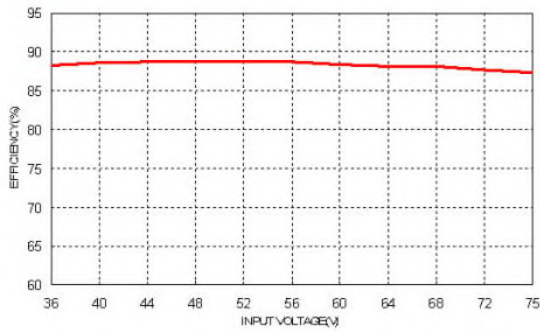

Efficiency Versus Input Voltage. Full Load

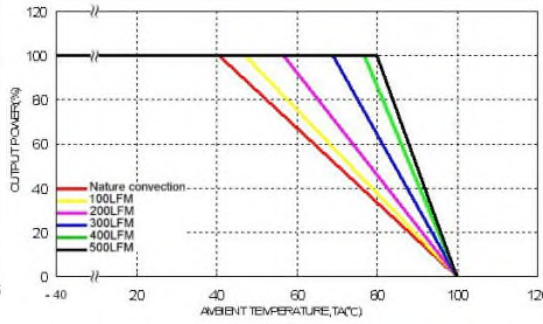

Derating Output Current Versus Ambient Temperature and Airflow Vin = Vin(nom)

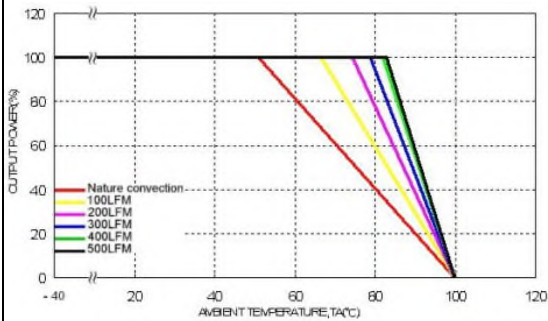

Derating Output Current Versus Ambient Temperature with Heat-Sink and Airflow, Vin = Vin(nom)

Characteristic Curves (Continued)

All test conditions are at 25°C. The figures are for PXF40-48D12

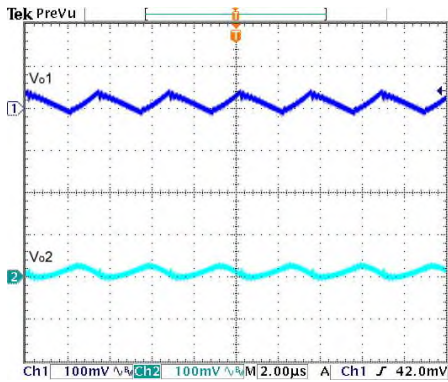

Typical Output Ripple and Noise.
 $V_{in} = V_{in(nom)}$, Full Load

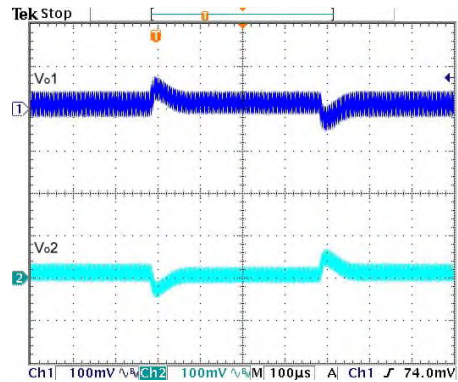

Transient Response to Dynamic Load Change from
 100% to 75% to 100% of Full Load ; $V_{in} = V_{in(nom)}$

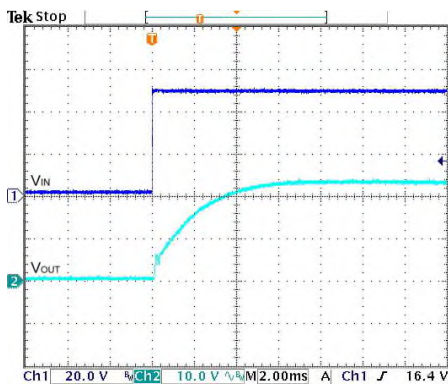

Typical Input Start-Up and Output Rise Characteristic
 $V_{in} = V_{in(nom)}$, Full Load

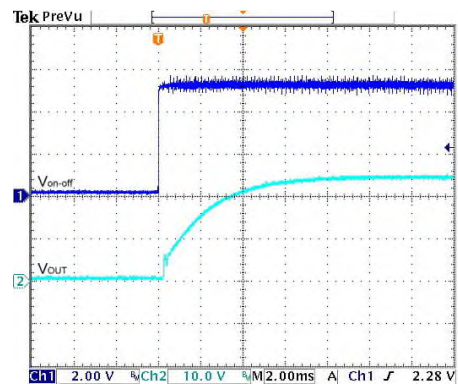

Using ON/OFF Voltage Start-Up and V_o Rise Characteristic
 $V_{in} = V_{in(nom)}$, Full Load

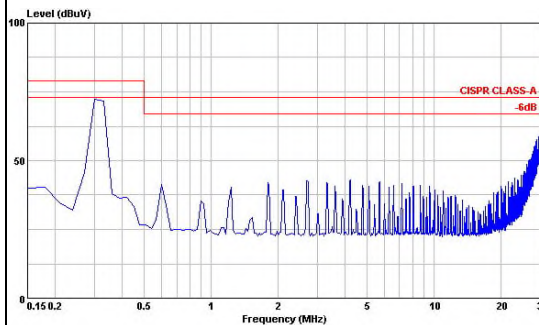

Conduction Emission of EN55022 Class A
 $V_{in} = V_{in(nom)}$, Full Load

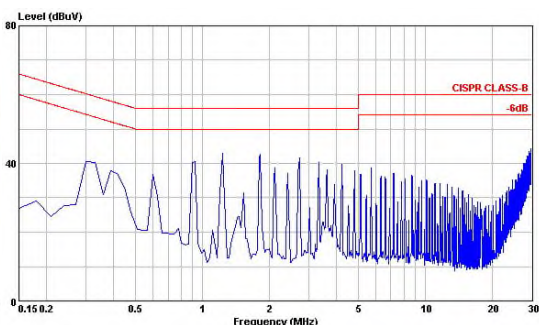

Conduction Emission of EN55022 Class B
 $V_{in} = V_{in(nom)}$, Full Load

Characteristic Curves (Continued)

All test conditions are at 25°C. The figures are for PXF40-48D15

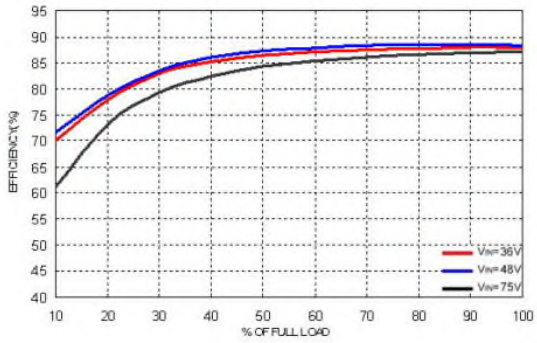

Efficiency Versus Output Current

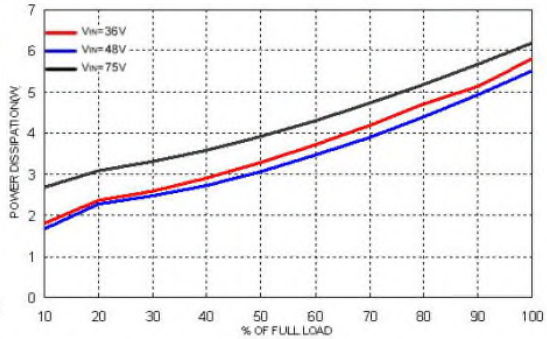

Power Dissipation Versus Output Current

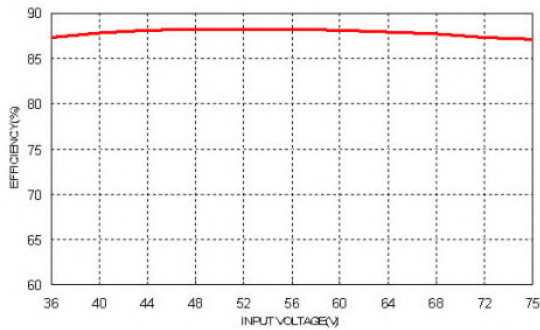

Efficiency Versus Input Voltage. Full Load

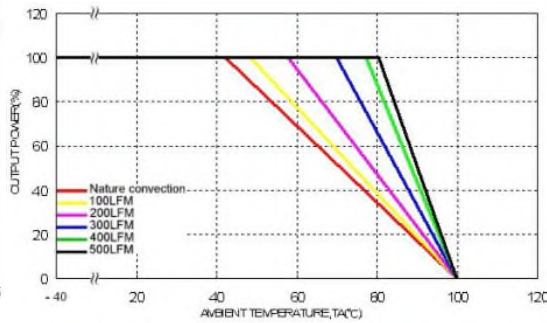

Derating Output Current Versus Ambient Temperature and Airflow Vin = Vin(nom)

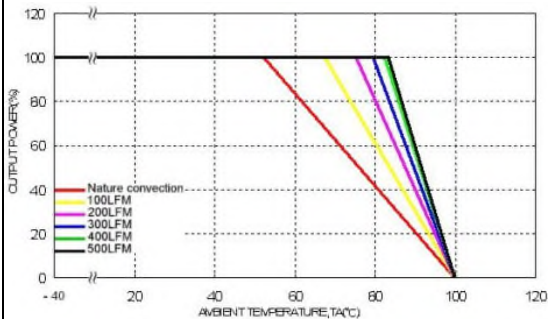

Derating Output Current Versus Ambient Temperature with Heat-Sink and Airflow, Vin = Vin(nom)

Characteristic Curves (Continued)

All test conditions are at 25°C. The figures are for PXF40-48D15

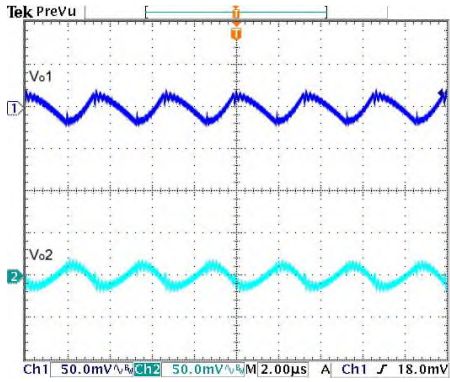

Typical Output Ripple and Noise.
Vin = Vin(nom), Full Load

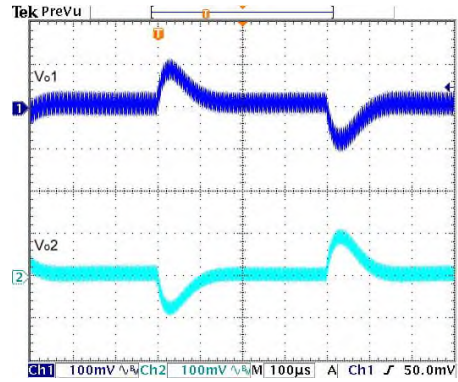

Transient Response to Dynamic Load Change from
100% to 75% to 100% of Full Load ; Vin = Vin(nom)

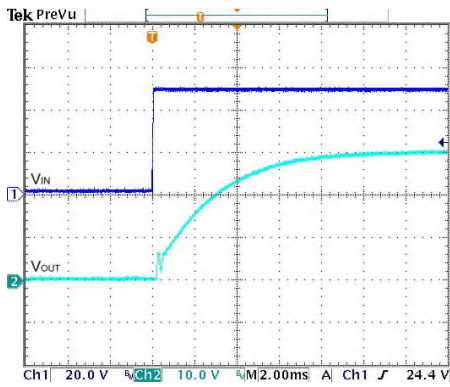

Typical Input Start-Up and Output Rise Characteristic
Vin = Vin(nom), Full Load

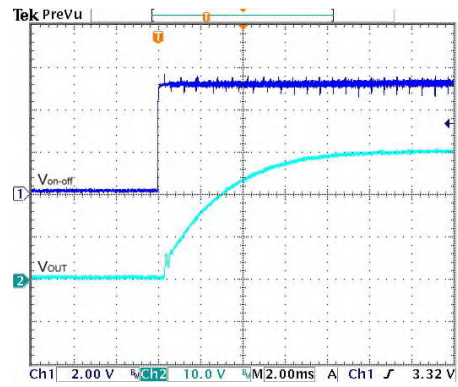

Using ON/OFF Voltage Start-Up and Vo Rise Characteristic
Vin = Vin(nom), Full Load

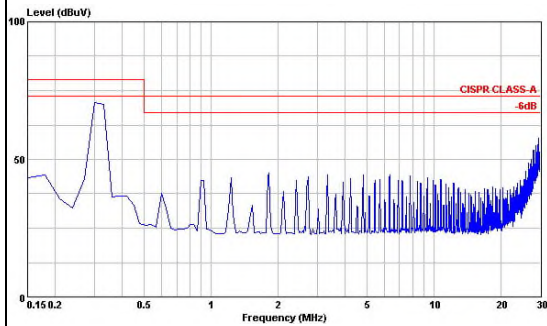

Conduction Emission of EN55022 Class A
Vin = Vin(nom), Full Load

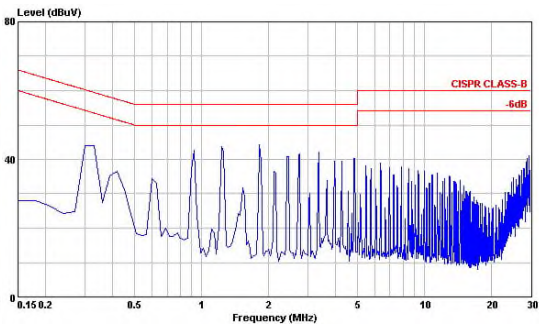

Conduction Emission of EN55022 Class B
Vin = Vin(nom), Full Load

Characteristic Curves (Continued)

All test conditions are at 25°C. The figures are for PXF40-48D3305

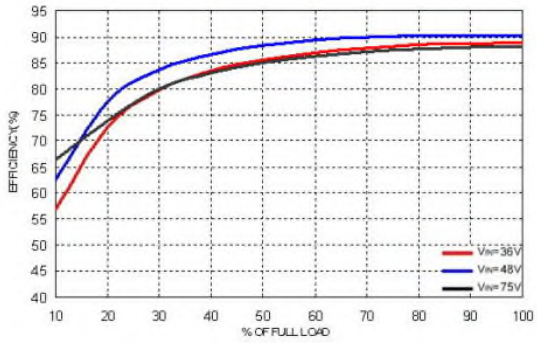

Efficiency Versus Output Current

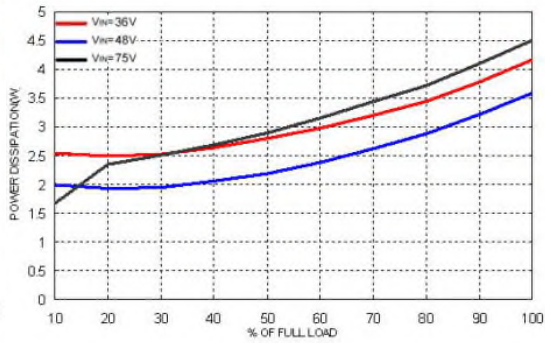

Power Dissipation Versus Output Current

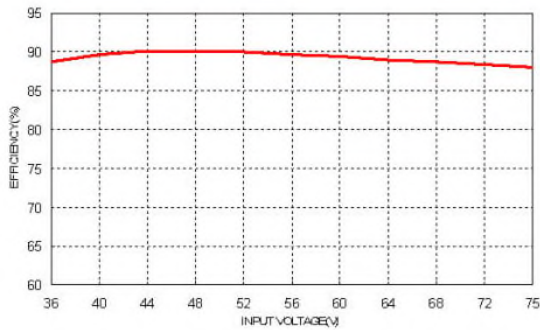

Efficiency Versus Input Voltage. Full Load

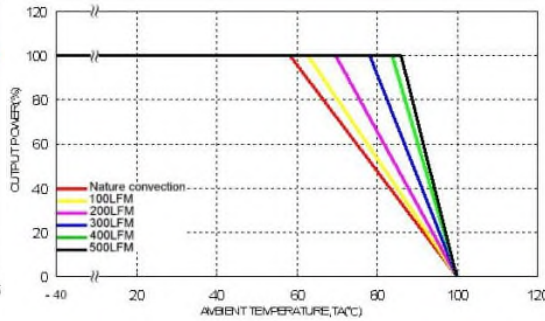

Derating Output Current Versus Ambient Temperature and Airflow
Vin = Vin(nom)

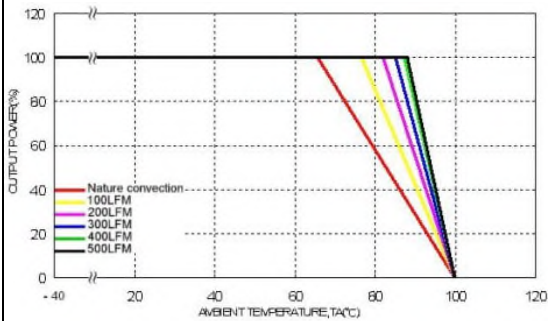

Derating Output Current Versus Ambient Temperature with Heat-Sink
and Airflow, Vin = Vin(nom)

Characteristic Curves (Continued)

All test conditions are at 25°C. The figures are for PXF40-48D3305

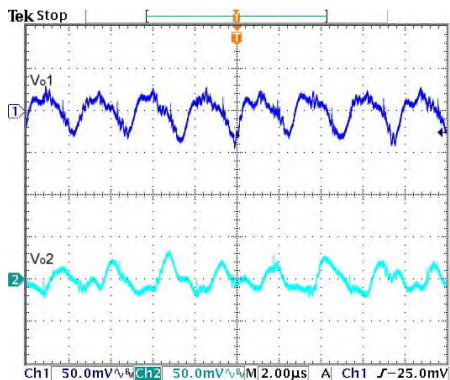

Typical Output Ripple and Noise.
 $V_{in} = V_{in(nom)}$, Full Load

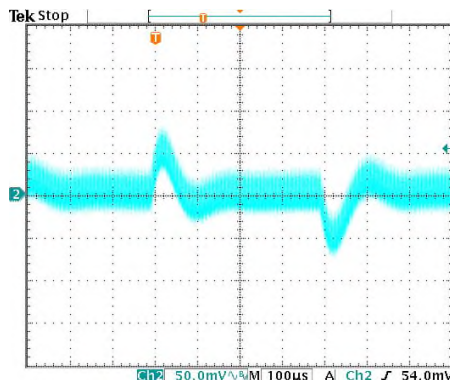

+5Vo:
 Transient Response to Dynamic Load Change from 100% to 75% to 100% of Full Load ; $V_{in} = V_{in(nom)}$
 +3.3Vo: Full load

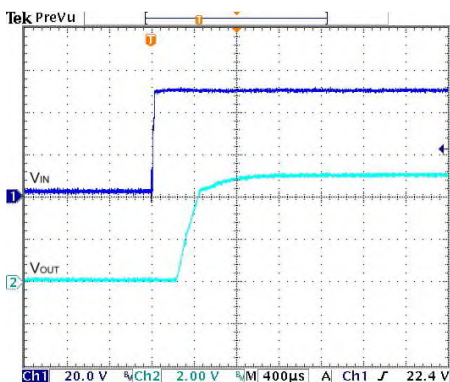

Typical Input Start-Up and Output Rise Characteristic
 $V_{in} = V_{in(nom)}$, Full Load

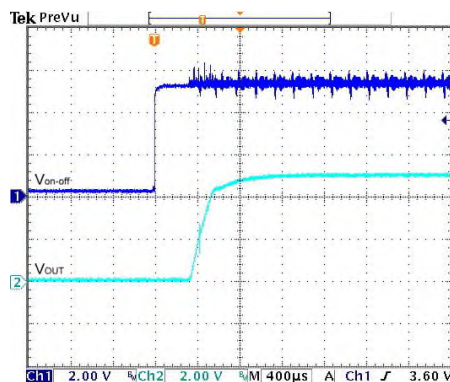

Using ON/OFF Voltage Start-Up and V_o Rise Characteristic
 $V_{in} = V_{in(nom)}$, Full Load

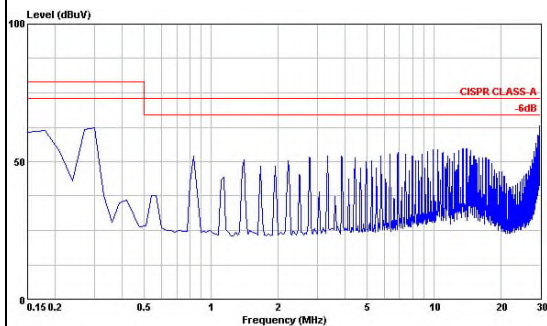

Conduction Emission of EN55022 Class A
 $V_{in} = V_{in(nom)}$, Full Load

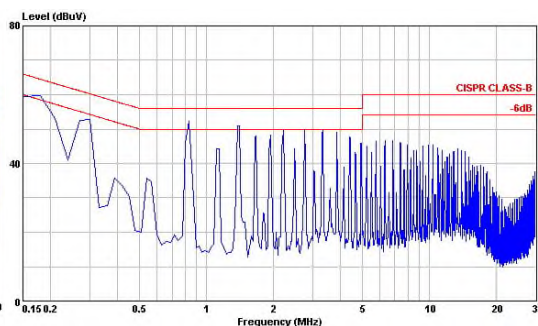

Conduction Emission of EN55022 Class B
 $V_{in} = V_{in(nom)}$, Full Load

Test Configurations

Input reflected-ripple current measurement test:

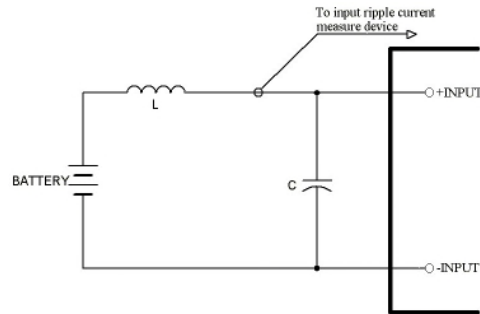

Component	Value	Voltage	Reference
L	12μH	---	---
C	220μF	100V	Aluminum Electrolytic Capacitor

Peak-to-peak output ripple & noise measurement test:

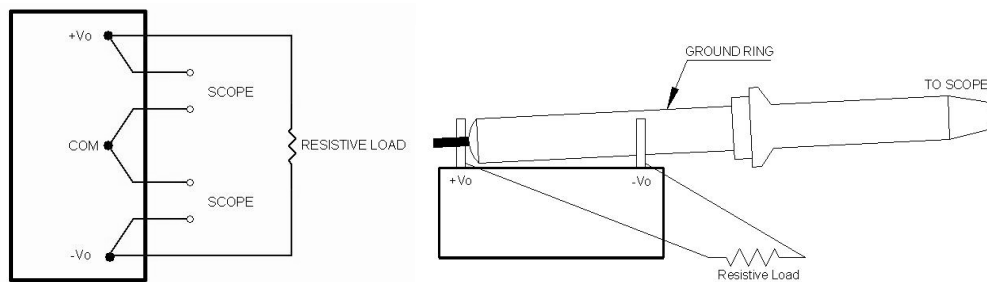

Output voltage and efficiency measurement test:

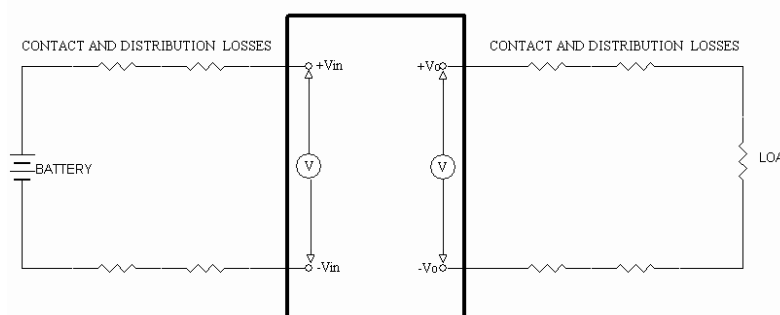

Note: All measurements are taken at the module terminals.

$$Efficiency = \left(\frac{V_o \times I_o}{V_{in} \times I_{in}} \right) \times 100\%$$

EMC Considerations

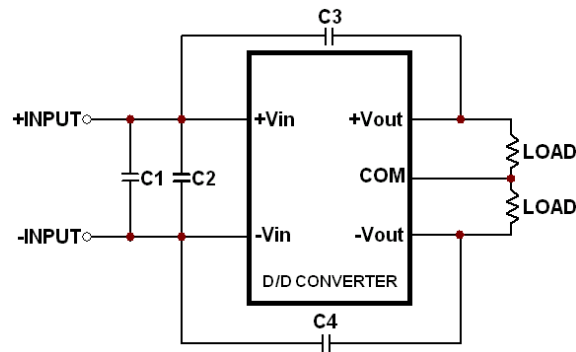

Suggested Schematic for EN55022 Conducted Emission Class A Limits

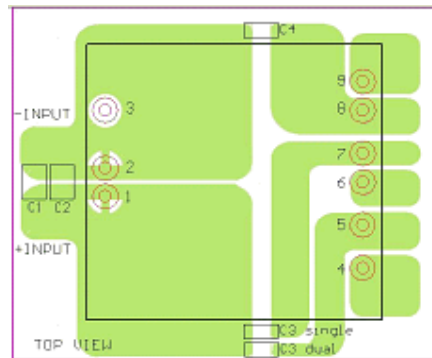

Recommended Layout with Input Filter

To meet conducted emissions EN55022 CLASS A needed the following components:

PXF40-12Dxx

Component	Value	Voltage	Reference
C1	6.8uF	50V	1812 MLCC
C3, C4	1000pF	2KV	1808 MLCC

PXF40-24Dxx

Component	Value	Voltage	Reference
C1	6.8uF	50V	1812 MLCC
C3, C4	1000pF	2KV	1808 MLCC

PXF40-48Dxx

Component	Value	Voltage	Reference
C1	2.2uF	100V	1812 MLCC
C3, C4	1000pF	2KV	1808 MLCC

EMC Considerations (Continued)

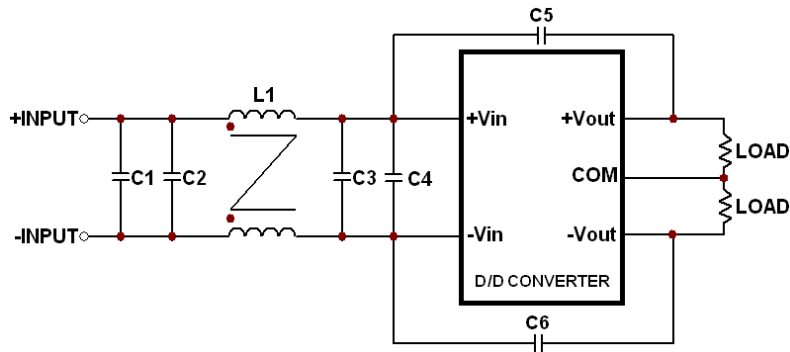

Suggested Schematic for EN55022 Conducted Emission Class B Limits

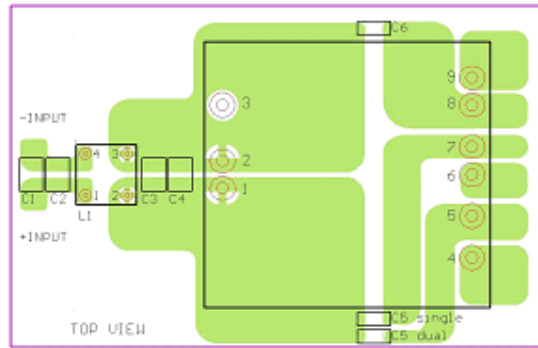

Recommended Layout with Input Filter

To meet conducted emissions EN55022 CLASS B needed the following components:

PXF40-12Dxx

Component	Value	Voltage	Reference
C1, C3	4.7uF	50V	1812 MLCC
C5, C6	1000pF	2KV	1808 MLCC
L1	450uH	---	Common Choke

PXF40-24Dxx

Component	Value	Voltage	Reference
C1, C3	6.8uF	50V	1812 MLCC
C5, C6	1000pF	2KV	1808 MLCC
L1	450uH	---	Common Choke

PXF40-48Dxx

Component	Value	Voltage	Reference
C1, C2	2.2uF	100V	1812 MLCC
C3, C4	2.2uF	100V	1812 MLCC
C5, C6	1000pF	2KV	1808 MLCC
L1	830uH	----	Common Choke

EMC Considerations (Continued)

Common Choke L1 is defined as follows:

- L: $450\mu\text{H} \pm 35\%$ / DCR: $25\text{m}\Omega$, max
A height: 9.8 mm, Max
- L-830 $\mu\text{H} \pm 35\%$ / DCR- $1\text{m}\Omega$, max
A height: 8.8 mm, Max
- Test condition: 100KHz / 100mV
- Recommended through hole: $\Phi 0.8\text{mm}$
- All dimensions in millimeters

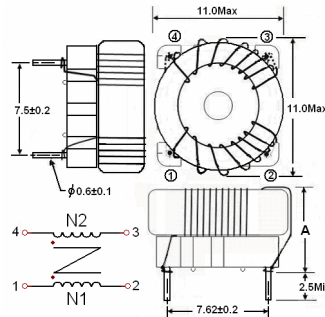

Input Source Impedance

The converter should be connected to a low impedance input source. Highly inductive source impedance can affect the stability of the converter. Input external L-C filter is recommended to minimize input reflected ripple current. The inductor is a simulated source impedance of $12\mu\text{H}$ and capacitor is Nippon chemi-con KY series $220\mu\text{F}/100\text{V}$. The capacitor must be located as close as possible to the input terminals of the converter for lowest impedance.

Output Over Current Protection

When excessive output currents occur in the system, circuit protection is required on all power supplies. Normally, overload current is maintained at approximately 150 percent of rated current for PXF40-xxDxx series.

Hiccup-mode is a method of operation in a converter whose purpose is to protect the power supply from being damaged during an over-current fault condition. It also enables the converter to restart when the fault is removed. There are other ways of protecting the converter when it is over-loaded, such as the maximum current limiting or current foldback methods.

One of the problems resulting from over current is that excessive heat may be generated in power devices; especially MOSFET and Schottky diodes and the temperature of these devices may exceed their specified limits. A protection mechanism has to be used to prevent these power devices from being damaged.

The operation of hiccup is as follows. When the current sense circuit sees an over-current event, the controller shuts off the converter for a given time and then tries to start up the converter again. If the over-load condition has been removed, the converter will start up and operate normally; otherwise, the controller will see another over-current event and will shut off the converter again, repeating the previous cycle. Hiccup operation has none of the drawbacks of the other two protection methods, although its circuit is more complicated because it requires a timing circuit. The excess heat due to overload lasts for only a short duration in the hiccup cycle, hence the junction temperature of the power devices is much lower.

Output Over Voltage Protection

The output over-voltage protection consists of an output Zener diode that monitors the voltage on the output terminals. If the voltage on the output terminals exceeds the over-voltage protection threshold, then the Zener diode clamps the output voltage.

Short Circuitry Protection

Continuous, hiccup and auto-recovery mode.

During a short circuit the converter shuts down. The average current during this condition will be very low.

Thermal Consideration

The converter operates in a variety of thermal environments. However, sufficient cooling should be provided to help ensure reliable operation of the unit. Heat is removed by conduction, convection, and radiation to the surrounding environment. Proper cooling can be verified by measuring the point as shown in the figure below. The temperature at this location should not exceed 100°C. When operating, adequate cooling must be provided to maintain the test point temperature at or below 100°C. Although the maximum point temperature of the power module is 100°C, limiting this temperature to a lower value will increase the reliability of the unit.

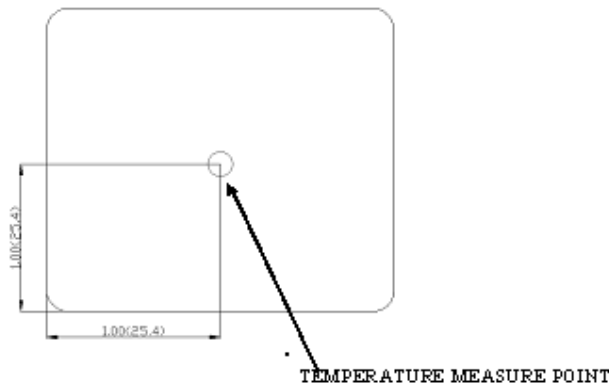

Heat Sink Consideration

Optional heat-sink (HAPXF) and optional heat sink clip (HAPXFCLIP); two clips required when used.

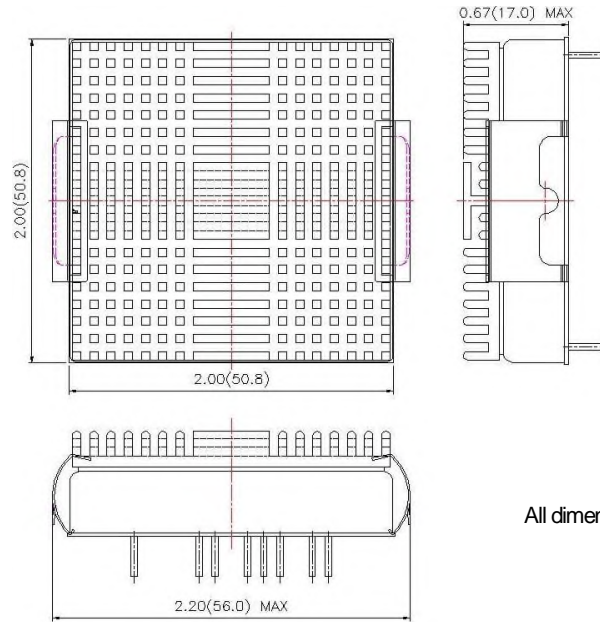

All dimensions in millimeters

Remote ON/OFF Control

The Remote ON/OFF Pin is used to turn on and off the DC-DC converter. The user must use a switch to control the logic voltage (high or low level) of the ON/OFF pin, referenced to $V_i (-)$. The switch can be an open collector transistor, FET, or Opto-Coupler, that is capable of sinking up to 0.5 mA at a low-level logic voltage. For high-level logic of the ON/OFF signal (maximum voltage): the allowable leakage current of the switch at 12V is 0.5 mA.

Remote ON/OFF Implementation Circuits

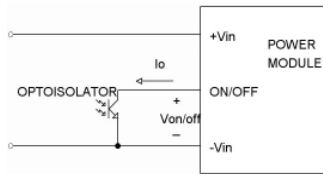

Isolated-Control Remote ON/OFF

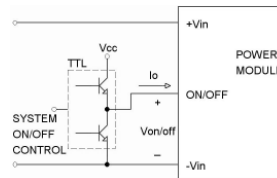

Level Control Using TTL Output

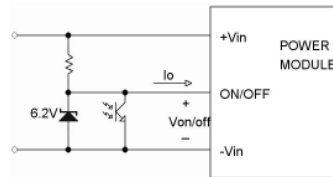

Level Control Using Line Voltage

Positive logic:

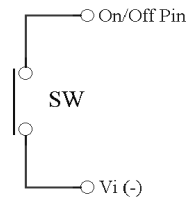

PXF40 module is turned off at Low-level logic

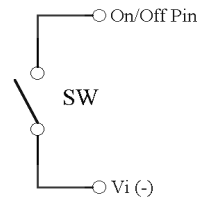

PXF40 module is turned on at High-level logic

Mechanical Data

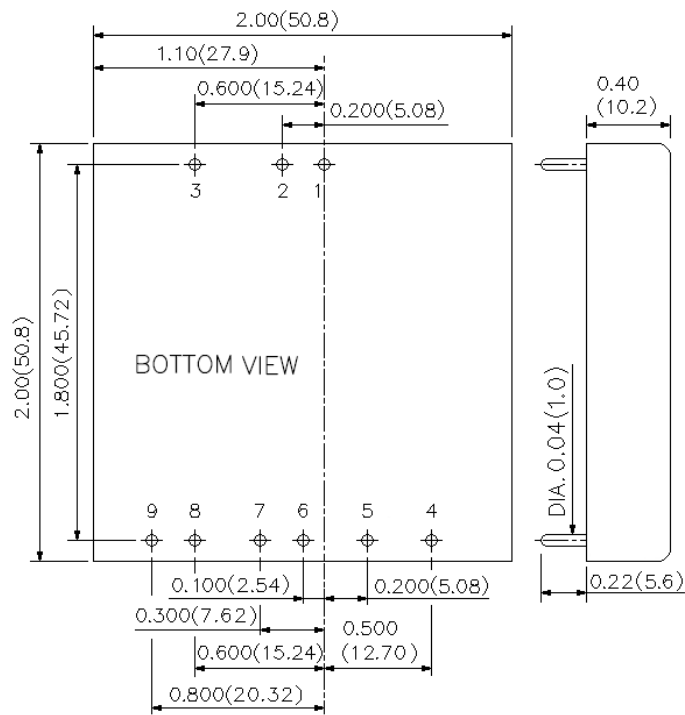

1. All dimensions in Inches (mm)
Tolerance: X.XX±0.02 (X.X±0.5)
X.XXX±0.01 (X.XX±0.25)
2. Pin pitch tolerance ±0.01(0.25)
3. Pin dimension tolerance ±0.004 (0.1)

PIN CONNECTION		
PIN	DUAL	DUAL POSITIVE
1	+INPUT	+INPUT
2	-INPUT	-INPUT
3	CTRL	CTRL
4	NO PIN	3.3V
5	+OUTPUT	COMMON
6	COMMON	NC
7	COMMON	NC
8	-OUTPUT	5V
9	TRIM	COMMON

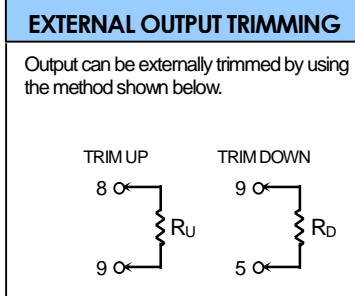

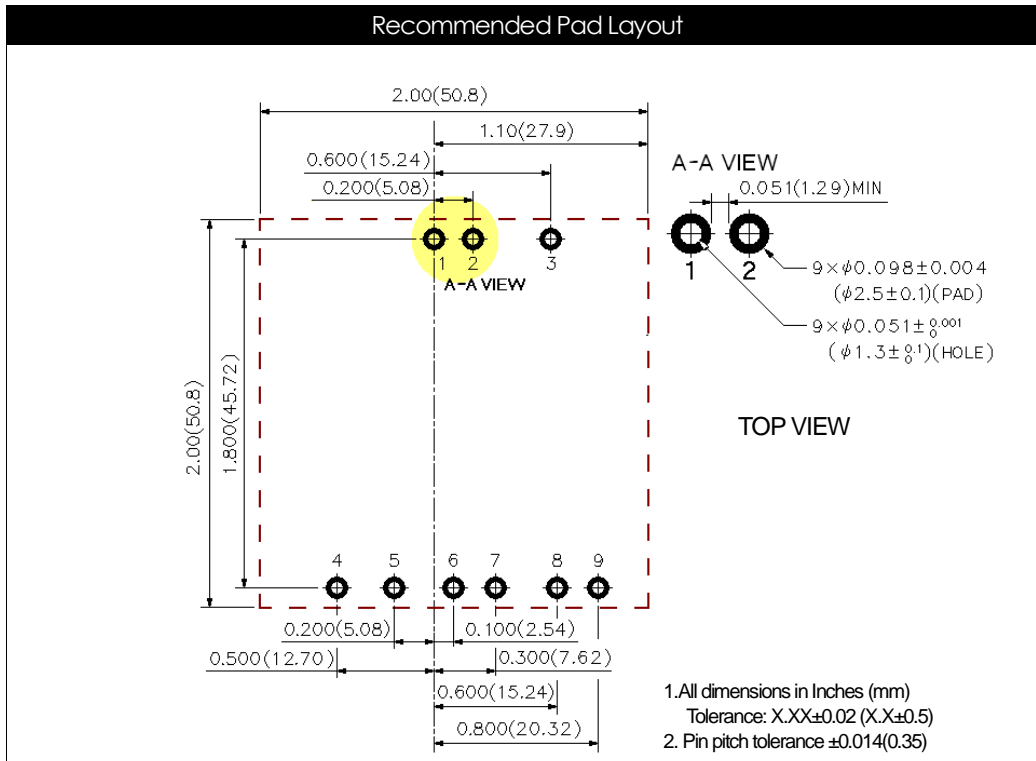

Output Voltage Adjustment

Output voltage set point adjustment allows the user to increase or decrease the output voltage set point of a module. This is accomplished by connecting an external resistor between the TRIM pin and either the Vo(+) or Vo(-) pins. With an external resistor between the TRIM and Vo(-) pin, the output voltage set point increases. With an external resistor between the TRIM and Vo(+) pin, the output voltage set point decreases.

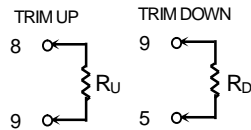

TRIM TABLE

PXF40-xxD12

Trim up (%)	1	2	3	4	5	6	7	8	9	10
V _{OUT} (Volts)=	±12.12	±12.24	±12.36	±12.48	±12.6	±12.72	±12.84	±12.96	±13.08	±13.2
R _U (K Ohms)=	218.21	98.105	58.07	38.052	26.042	18.035	12.316	8.026	4.69	2.021
Trim down (%)	1	2	3	4	5	6	7	8	9	10
V _{OUT} (Volts)=	±11.88	±11.76	±11.64	±11.52	±11.4	±11.28	±11.16	±11.04	±10.92	±10.8
R _D (K Ohms)=	273.44	123.02	72.874	47.803	32.76	22.732	15.568	10.196	6.017	2.675

PXF40-xxD15

Trim up (%)	1	2	3	4	5	6	7	8	9	10
V _{OUT} (Volts)=	±15.15	±15.3	±15.45	±15.6	±15.75	±15.9	±16.05	±16.2	±16.35	±16.5
R _U (K Ohms)=	268.29	120.64	71.429	46.822	32.058	22.215	15.184	9.911	5.81	2.529
Trim down (%)	1	2	3	4	5	6	7	8	9	10
V _{OUT} (Volts)=	±14.85	±14.7	±14.55	±14.4	±14.25	±14.1	±13.95	±13.8	±13.65	±13.5
R _D (K Ohms)=	337.71	152.02	90.126	59.178	40.609	28.23	19.387	12.756	7.598	3.471

Soldering and Reflow Consideration

Lead free wave solder profile for PXF40-xxDxx DIP type

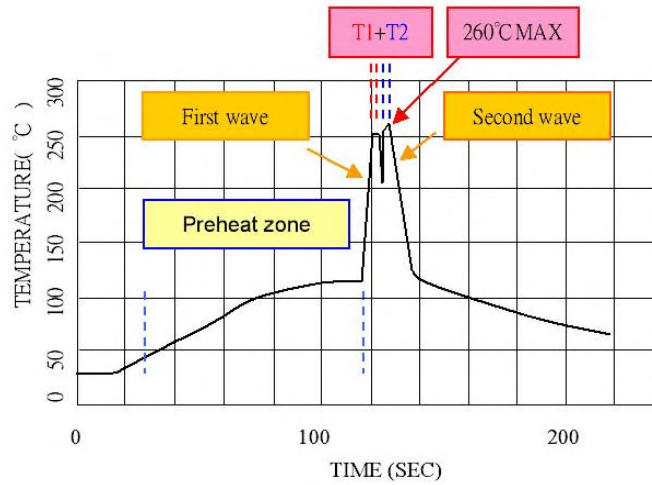

Zone	Reference Parameter
Preheat zone	Rise temp. speed : 3°C / sec max. Preheat temp. : 100~130°C
Actual heating	Peak temp. : 250~260°C Peak time (T1+T2 time) : 4~6 sec

Reference Solder: Sn-Ag-Cu /Sn-Cu

Hand Welding: Soldering iron-Power 90W

Welding Time: 2-4 sec

Temp.:380-400 °C

Packaging Information

10 PCS per TUBE

Part Number Structure

PXF 40 - 48 D 12

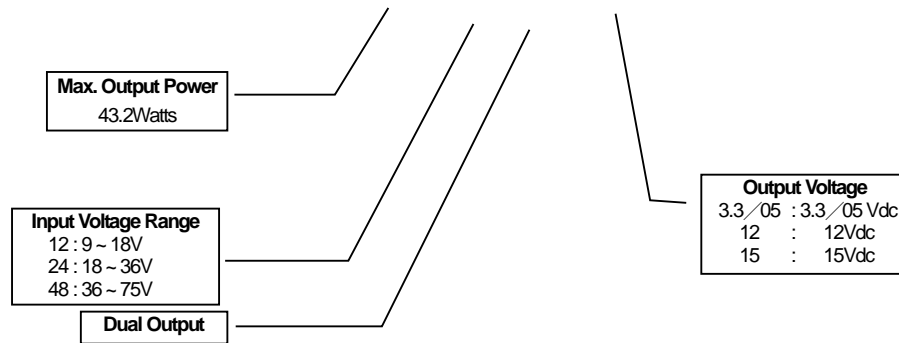

Model Number	Input Range	Output Voltage	Output Current		Input Current		Eff ⁽⁴⁾ (%)
			Min. load	Full load	No load ⁽²⁾	Full Load ⁽³⁾	
PXF40-12D12	9 – 18 VDC	± 12 VDC	± 144mA	± 1800mA	30mA	4444mA	85
PXF40-12D15	9 – 18 VDC	± 15 VDC	± 112mA	± 1400mA	35mA	4321mA	85
PXF40-12D3305	9 – 18 VDC	3.3 / 5 VDC	0mA	4A / 4A (total 8A) ⁽¹⁾	325mA	3416mA	85
PXF40-24D12	18 – 36 VDC	± 12 VDC	± 144mA	± 1800mA	20mA	2169mA	87
PXF40-24D15	18 – 36 VDC	± 15 VDC	± 112mA	± 1400mA	20mA	2108mA	87
PXF40-24D3305	18 – 36 VDC	3.3 / 5 VDC	0mA	4A / 4A (total 8A) ⁽¹⁾	80mA	1689mA	86
PXF40-48D12	36 – 75 VDC	± 12 VDC	± 144mA	± 1800mA	15mA	1084mA	87
PXF40-48D15	36 – 75 VDC	± 15 VDC	± 112mA	± 1400mA	15mA	1054mA	87
PXF40-48D3305	36 – 75 VDC	3.3 / 5 VDC	0mA	4A / 4A (total 8A) ⁽¹⁾	45mA	823mA	88

Note 1. Any condition of dual output (3.3V/5V) rated lout current, not to exceed 8A of total output currents. The product safety approval pending.

Note 2. Typical value at nominal input voltage and no load.

Note 3. Maximum value at nominal input voltage and full load

Note 4. Typical value at nominal input voltage and full load.

Safety and Installation Instruction

Fusing Consideration

Caution: This converter is not internally fused. An input line fuse must always be used.

This encapsulated converter can be used in a wide variety of applications, ranging from simple stand-alone operation to an integrated part of a sophisticated power architecture. To maximum flexibility, internal fusing is not included; however, to achieve maximum safety and system protection, always use an input line fuse. The safety agencies require a slow-blow fuse with maximum rating of 8A. Based on the information provided in this data sheet on Inrush energy and maximum DC input current; the same type of fuse with lower rating can be used. Refer to the fuse manufacturer's data for further information.

MTBF and Reliability

The MTBF of PXF40-xxDxx dual output DC/DC converters has been calculated using

Bellcore TR-NWT-000332 Case I: 50% stress, Operating Temperature at 40°C (Ground fixed and controlled environment). The resulting figure for MTBF is 1.398×10^6 hours.

MIL-HDBK-217F NOTICE2 FULL LOAD, Operating Temperature at 25°C °C. The resulting figure for MTBF is 3.585×10^5 hours.